

REV.	EN. NO.	DESCRIPTION	SIGN	DATE
C1	N/A	INITIAL DRAWING	Liu	2019/08/13

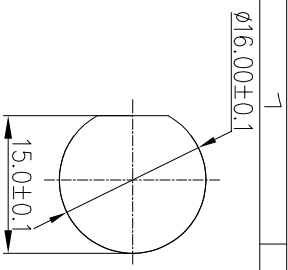

Recommended Panel Cut-Out

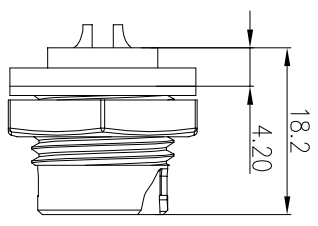

Panel T: Max 3.0

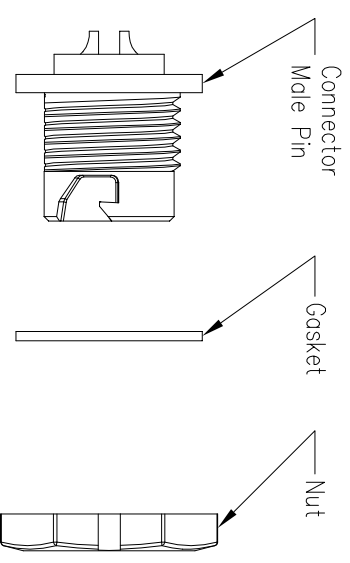
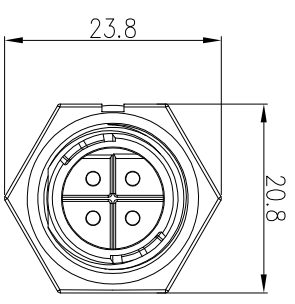
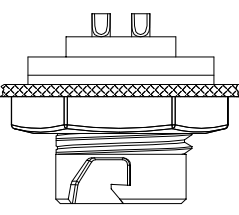

22XXXX535-01

Pin Number

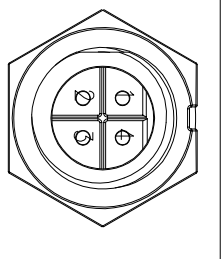

4 Pin

P/N: 22004535-01

Pin Assignments
Front View

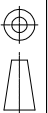

TOLERANCE

.X	±0.25
.XX	±0.15
.XXX	±0.05
ANGLES	±1'

DESCRIPTION

Standard Series Push Lock
Front Mount With Male Pin

SCALE	1:1	SHEET	1 OF 1
REV	C1	SIZE	A4

* : Inspection Item

CHOGORI

PART NO 22XXXX535-01

DRAWN BY Liu

DATE 2019/08/13

DWG NO

CHECKED BY Mo

DATE 2019/08/13

CUSTOMER

APPROVED BY Ponsoon

DATE 2019/08/13

- Specification:
1. Operation Temperature: -45°C~105°C.
 2. Insulation Resistance: 100MΩ at DC500V.
 3. Contact Resistance: <10mΩ.
 4. Withstand Voltage: 1500V AC
 5. Operating Current: 10A
 6. Operating Voltage: AC 125V
 7. Waterproof Rate: IP67 (Mated)
 8. Housing: Nylon, Black
 9. Male Pin: Copper Alloy, Gold Plated
 10. Gasket: Silicon Gray
 11. Panel Nut: Nylon, Orange
 12. Torque Rate: 0.8~1.0N•m
 13. RoHS Compliant.
 14. UL Compliant.
 15. Mating Cap P/N: 806-00053-00