

Data sheet | Item number: 899-632

Distribution box; for self-assembly; black

[www.wago.com/899-632](http://www.wago.com/899-632)

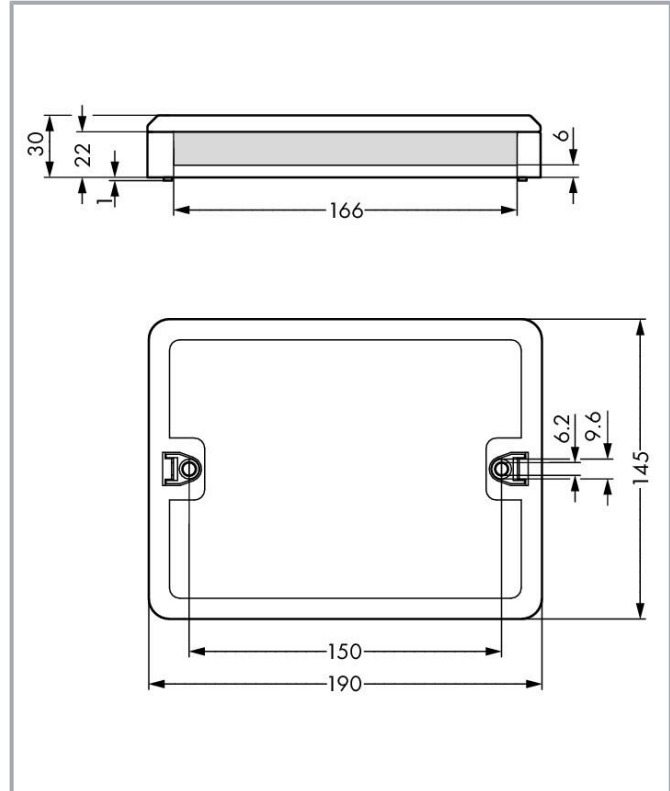
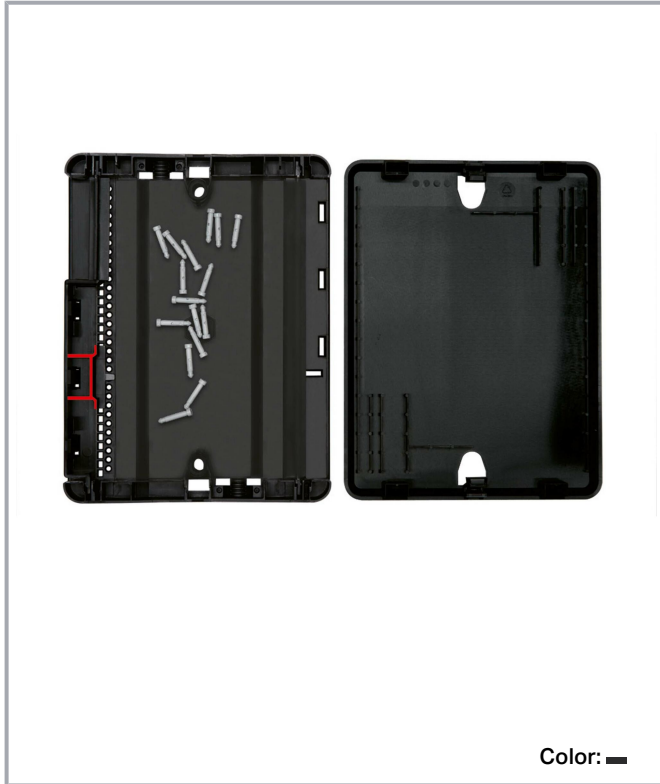

## Item description

### Empty housings *WINSTA*®

Implement your installation project with ease: The empty housings from the *WINSTA*® product line is the product of your choice for quick, straightforward installation. You can rely on the quality of *WINSTA*® components from WAGO for your electrical installation accessories too.

### Lower costs through fast commissioning and elimination of service expenses – solutions from *WINSTA*®

The *WINSTA*® Pluggable Connection System is ideally tailored to the strict requirements of building installation. It makes electrical installation pluggable, and consequently more efficient, more reliable, and error-free. Using this pre-assembled system reduces time spent on assembly and

Subject to changes. Please also observe the further product documentation!

WAGO GmbH & Co. KG  
Hansastr. 27  
32423 Minden  
Phone: +49571 887-0 | Fax: +49571 887-169  
Email: [info.de@wago.com](mailto:info.de@wago.com) | Web: [www.wago.com](http://www.wago.com)

Do you have any questions about our products?  
We are always happy to take your call at +49 (571) 887-44222.



installation errors at the construction site. Enjoy the benefits of the pluggable version of our maintenance-free spring pressure connection technology too! Plan your installation with *WINSTA*® distribution boxes from WAGO.

- intuitive marking
- saves time, since no wiring is required at the construction site
- rapid, structured electrical installation

## Data

### Notes

Note	For easy cable connection, do not arrange the connectors directly next to each other in the distribution box.
------	---

### Physical data

Width	190 mm / 7.48 inches
Height	30 mm / 1.181 inches
Depth	145 mm / 5.709 inches

### Mechanical Data

Mounting type	Wall, screw mount Installation on mounting plate
---------------	---

### Material Data

Note (material data)	Information on material specifications can be found <a href="#">here</a>
----------------------	--

Color	black
Insulation material	Polyamide (PA66)
Flammability class per UL94	V0
Fire load	5.783 MJ
Weight	186.8 g

### Environmental requirements

Processing temperature	-5 ... +40 °C
Continuous operating temperature	-35 ... +85 °C
Note on continuous operating temperature	Insulating parts for temperatures ≤ 105 °C

Subject to changes. Please also observe the further product documentation!

## Commercial data







eCl@ss 10.0	27-44-06-03
eCl@ss 9.0	27-44-06-03
ETIM 8.0	EC002567
ETIM 7.0	EC002567
PU (SPU)	1 pcs
Packaging type	box
Country of origin	DE
GTIN	4055143315623
Customs tariff number	85366990990

## Environmental Product Compliance

RoHS Compliance Status	Compliant, No Exemption
------------------------	-------------------------

## Optional accessories

### Mounting

Mounting accessories		
	<b>Item no.: 890-303</b> Mounting carrier; 3-pole; for sockets and plugs; Plastic; gray	<a href="http://www.wago.com/890-303">www.wago.com/890-303</a>
	<b>Item no.: 890-304</b> Mounting carrier; 4-pole; for sockets and plugs; Plastic; gray	<a href="http://www.wago.com/890-304">www.wago.com/890-304</a>
	<b>Item no.: 890-305</b> Mounting carrier; 5-pole; for sockets and plugs; Plastic; gray	<a href="http://www.wago.com/890-305">www.wago.com/890-305</a>
	<b>Item no.: 770-630</b> Fixing pin; for distribution boxes; Plastic; gray	<a href="http://www.wago.com/770-630">www.wago.com/770-630</a>
	<b>Item no.: 890-302</b> Mounting carrier; 2-pole; for sockets and plugs; Plastic; gray	<a href="http://www.wago.com/890-302">www.wago.com/890-302</a>
	<b>Item no.: 899-680</b> Mounting plate; for distribution boxes; gray	<a href="http://www.wago.com/899-680">www.wago.com/899-680</a>

Subject to changes. Please also observe the further product documentation!

## Downloads Documentation

### Bid Text

899-632 X81 - Datei	2019 Feb 19	xml 3.2 kB	Download
899-632 doc - Datei	2015 Mar 16	doc 24.6 kB	Download

## Environmental Product Compliance

### Compliance Search

Environmental Product Compliance 899-632 Distribution box; for self-assembly; black	URL	Download
--	-----	----------

## Installation Notes

### Installation



Securing the mounting plate with WINSTA®  
Distribution Box to the wall (e.g., via stud gun).

### Application

Subject to changes. Please also observe the further product documentation!



The set includes: 1 bottom, 1 lid, 2 sidewalls and 16 mounting pins.



Remove unrequired sections from the sidewalls.

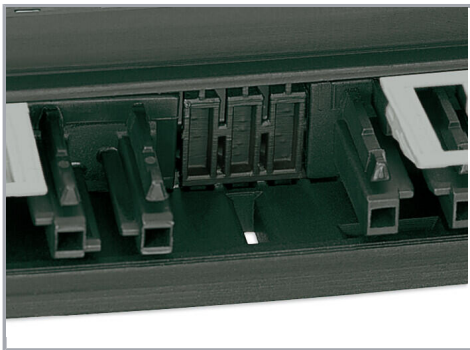

Unassigned slots and spaces are closed by inserting a sidewall.

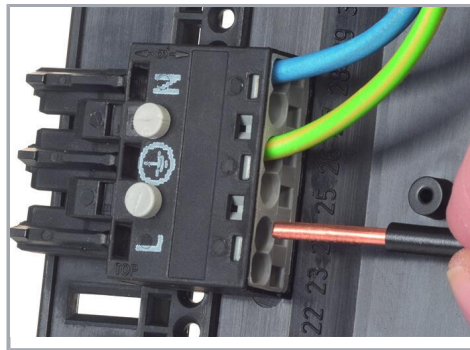

Using mounting pins to secure WINSTA<sup>®</sup> MIDI connectors in a distribution box.

Subject to changes. Please also observe the further product documentation!

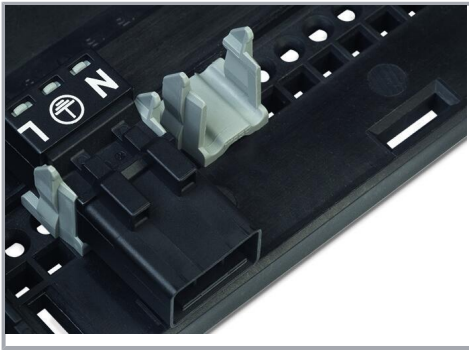

Using adapters to install WINSTA® MINI connectors in a distribution box

## Product family

### WINSTA® boxes

WINSTA® ist das Steckverbindersystem, das optimal auf die hohen Anforderungen in der Gebäudeinstallation zugeschnitten ist. Es macht die Elektroinstallation steckbar und dadurch schnell, sicher und fehlerfrei. Dies gilt auch in weiteren Anwendungen wie z. B. im Schiffbau, in der Bahntechnik oder in der Industrie.

[Show all products from the family](#)

Subject to changes. Please also observe the further product documentation!