

CARMEN-50-M-C

~35° medium beam. Assembly with holder C compatible with LEDiL HEKLA.

TECHNICAL SPECIFICATIONS:

Dimensions	Ø 50.0 mm
Height	25.5 mm
Fastening	socket
Colour	black
Box size	476 x 273 x 292 mm
Box weight	5.9 kg
Quantity in Box	308 pcs
ROHS compliant	yes ⓘ

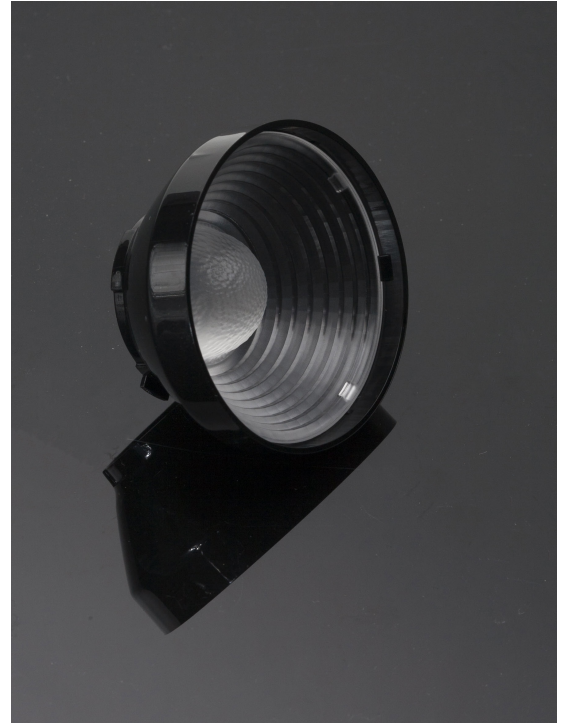

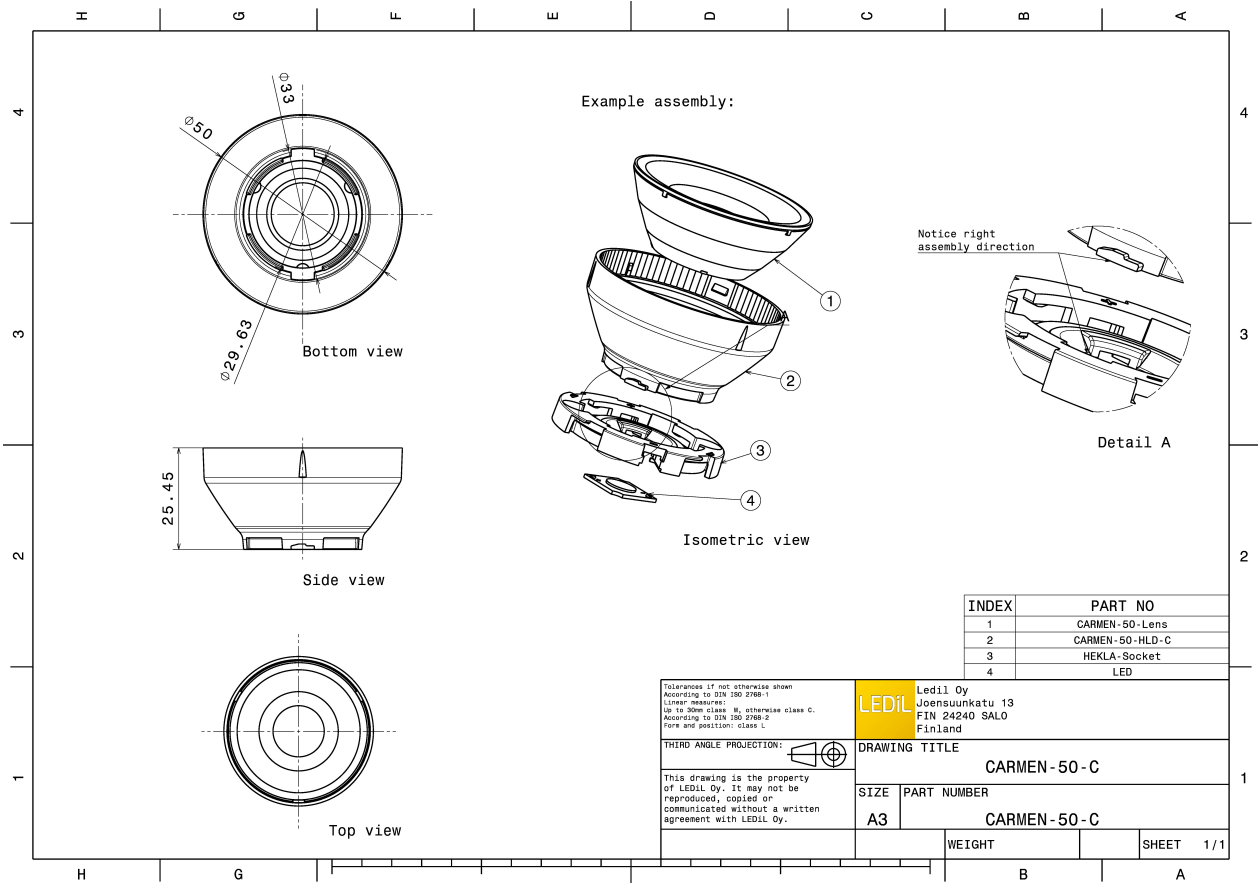

MATERIAL SPECIFICATIONS:

Component	Type	Material	Colour
CARMEN-50-M	Single lens	PMMA	clear
CARMEN-50-HLD-C	Holder	PC	

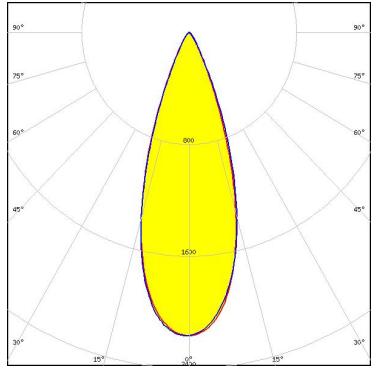
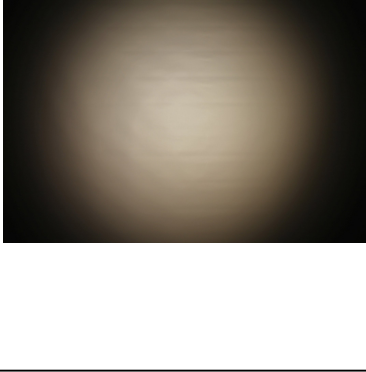
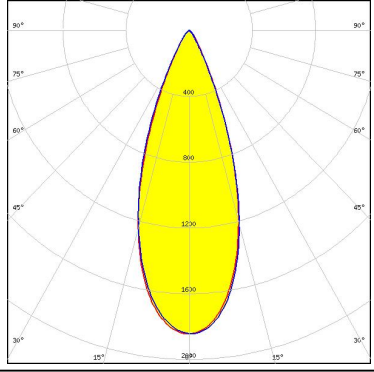
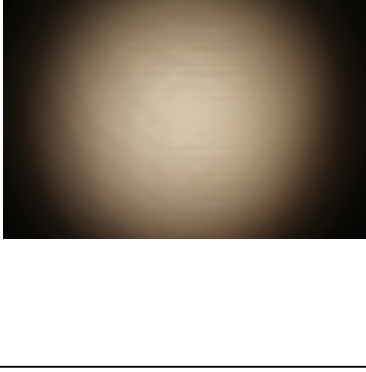
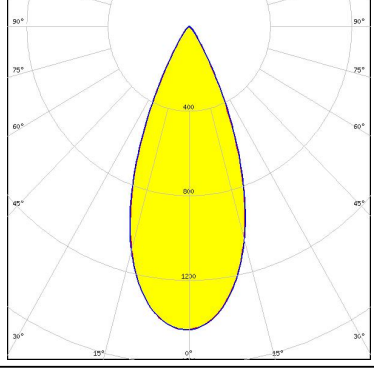

PHOTOMETRIC DATA (MEASURED):

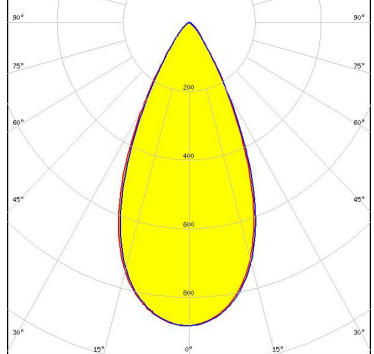
<p>bridgelux.</p> <p>LED V4 HD FWHM 35.0° Efficiency 84 % Peak intensity 2.200 cd/lm LEDs/each optic 1 Light colour White Required components: F15253_HEKLA-SOCKET-A</p>		
<p>bridgelux.</p> <p>LED V6 HD FWHM 38.0° Efficiency 81 % Peak intensity 1.850 cd/lm LEDs/each optic 1 Light colour White Required components: F15255_HEKLA-SOCKET-C</p>		
<p>bridgelux.</p> <p>LED V9 HD FWHM 43.0° Efficiency 75 % Peak intensity 1.440 cd/lm LEDs/each optic 1 Light colour White Required components: F15859_HEKLA-SOCKET-I</p>		
<p>bridgelux.</p> <p>LED VERO13 FWHM 49.0° Efficiency 62 % Peak intensity 0.884 cd/lm LEDs/each optic 1 Light colour White Required components: C16142_HEKLA-SOCKET-K</p>		

PHOTOMETRIC DATA (MEASURED):

CITIZEN

LED CLL02x/CLU02x (LES10)
 FWHM 46.0°
 Efficiency 76 %
 Peak intensity 1.200 cd/lm
 LEDs/each optic 1
 Light colour White
 Required components:
 F15255_HEKLA-SOCKET-C

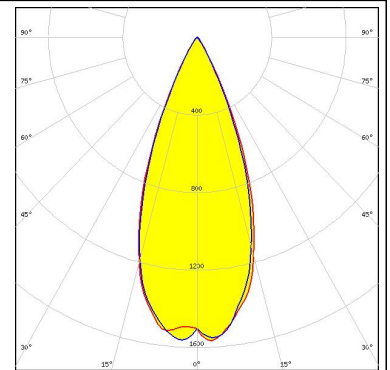

CITIZEN

LED CLU700/701
 FWHM 36.0°
 Efficiency 80 %
 Peak intensity 1.900 cd/lm
 LEDs/each optic 1
 Light colour White
 Required components:
 F15255_HEKLA-SOCKET-C

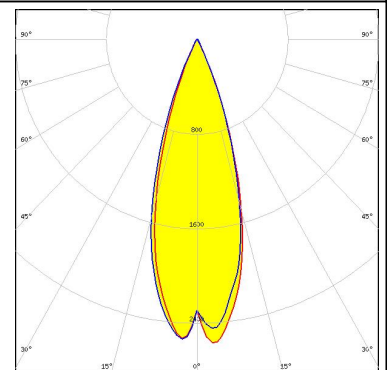
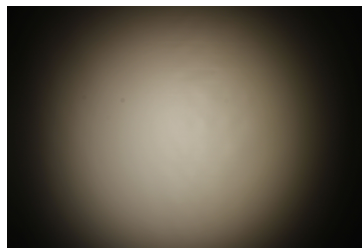

CITIZEN

LED CLU7A2 (LES 4.2mm)
 FWHM 35.0°
 Efficiency 84 %
 Peak intensity 2.200 cd/lm
 LEDs/each optic 1
 Light colour White
 Required components:
 F15255_HEKLA-SOCKET-C

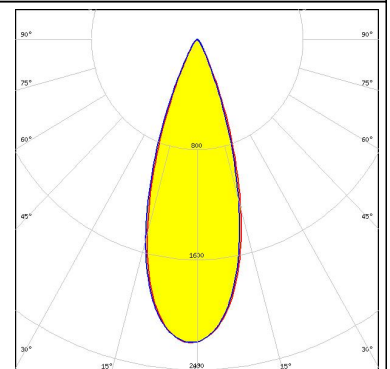
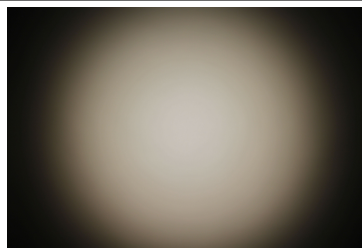

CREE

LED CMA1516
 FWHM 46.0°
 Efficiency 79 %
 Peak intensity 1.300 cd/lm
 LEDs/each optic 1
 Light colour White
 Required components:
 F15256_HEKLA-SOCKET-D

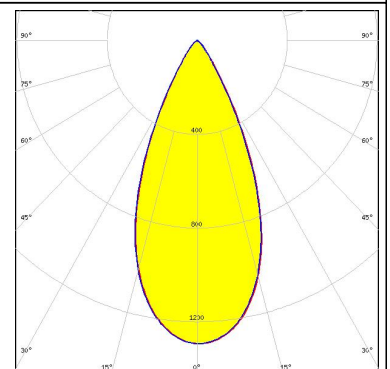
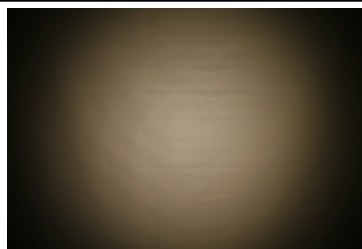

PHOTOMETRIC DATA (MEASURED):



LED CMT14xx
 FWHM 47.0°
 Efficiency 51 %
 Peak intensity 0.800 cd/lm
 LEDs/each optic 1
 Light colour White
 Required components:
 F15255_HEKLA-SOCKET-C

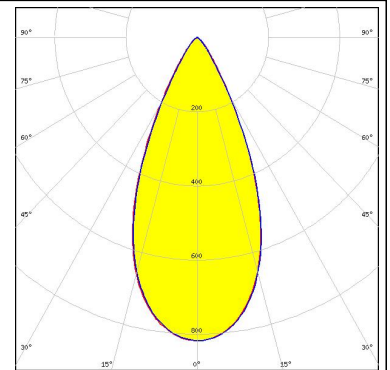
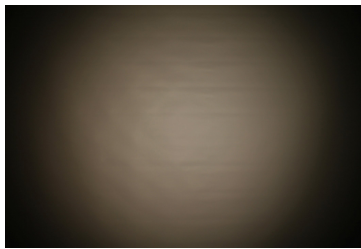

LED CXA/B 13xx
 FWHM 37.0°
 Efficiency 83 %
 Peak intensity 1.900 cd/lm
 LEDs/each optic 1
 Light colour White
 Required components:
 F15956_HEKLA-SOCKET-J

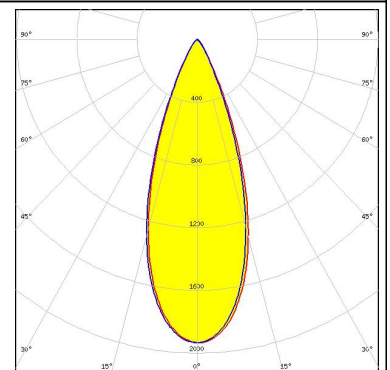
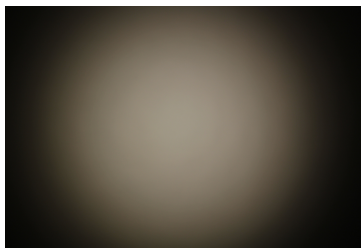

LED CXA/B 13xx
 FWHM 38.0°
 Efficiency 83 %
 Peak intensity 1.800 cd/lm
 LEDs/each optic 1
 Light colour White
 Required components:
 F15956_HEKLA-SOCKET-J

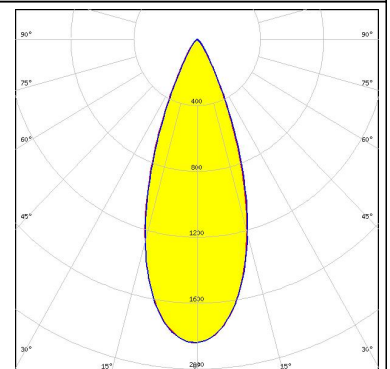
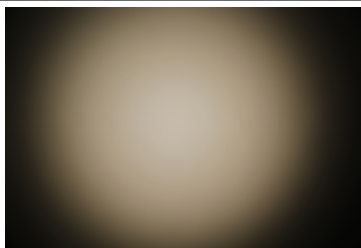

LED CXA/B 15xx
 FWHM 45.0°
 Efficiency 79 %
 Peak intensity 1.400 cd/lm
 LEDs/each optic 1
 Light colour White
 Required components:
 F15256_HEKLA-SOCKET-D

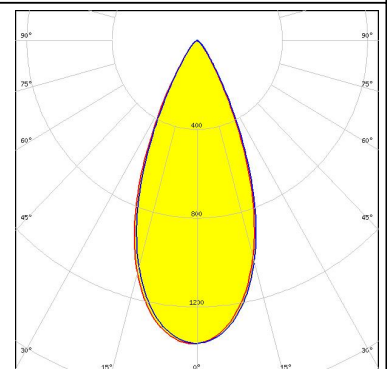
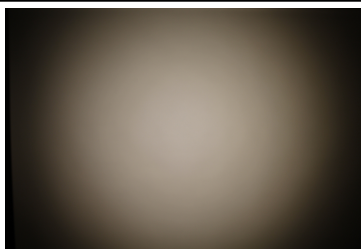

PHOTOMETRIC DATA (MEASURED):

LUMILEDS

LED LUXEON CoB 1202HD
 FWHM 38.0°
 Efficiency 82 %
 Peak intensity 1.830 cd/lm
 LEDs/each optic 1
 Light colour White
 Required components:
 F15848_HEKLA-SOCKET-G

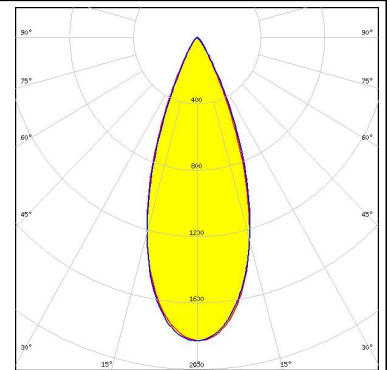
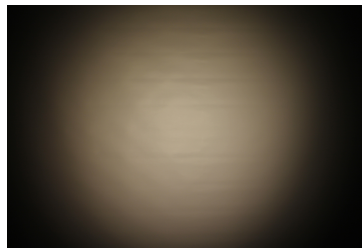

LUMILEDS

LED LUXEON CoB 1202s
 FWHM 37.0°
 Efficiency 81 %
 Peak intensity 1.900 cd/lm
 LEDs/each optic 1
 Light colour White
 Required components:
 F15848_HEKLA-SOCKET-G

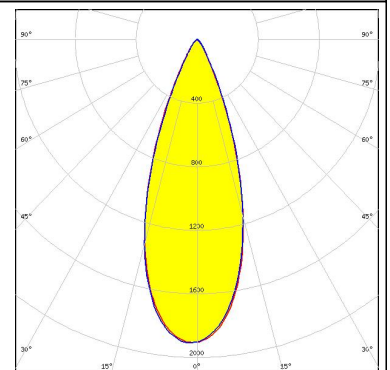
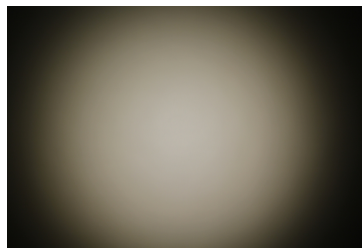

LUMINUS

LED CDM-6 (Dim-To-Warm)
 FWHM 34.0°
 Efficiency 63 %
 Peak intensity 1.700 cd/lm
 LEDs/each optic 1
 Light colour White
 Required components:
 C16142_HEKLA-SOCKET-K
 Bender Wirth: 490 Typ L8

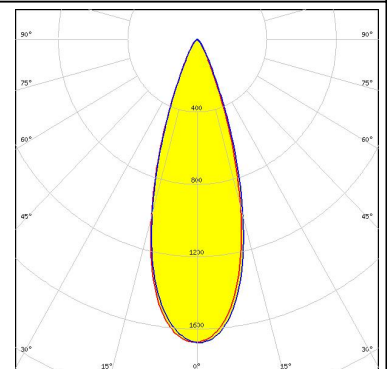
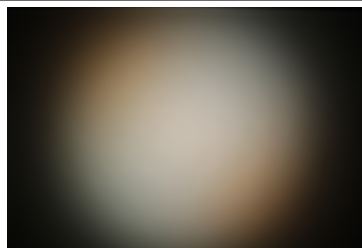

LUMINUS

LED CDM-9 (Dim-To-Warm)
 FWHM 40.0°
 Efficiency 61 %
 Peak intensity 1.300 cd/lm
 LEDs/each optic 1
 Light colour White
 Required components:
 C16142_HEKLA-SOCKET-K
 Bender Wirth: 490 Typ L8

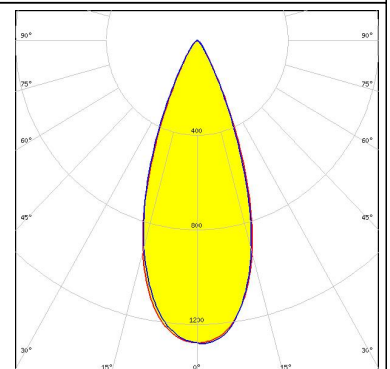
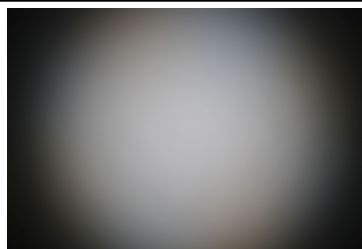

PHOTOMETRIC DATA (MEASURED):



LED CxM-9 (13.5x13.5)
 FWHM 46.0°
 Efficiency 77 %
 Peak intensity 1.300 cd/lm
 LEDs/each optic 1
 Light colour White
 Required components:
 F15255_HEKLA-SOCKET-C

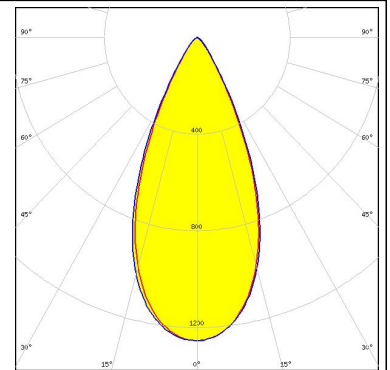

LED COB S-Type (LES 7)
 FWHM 39.0°
 Efficiency 80 %
 Peak intensity 1.700 cd/lm
 LEDs/each optic 1
 Light colour White
 Required components:
 F15848_HEKLA-SOCKET-G

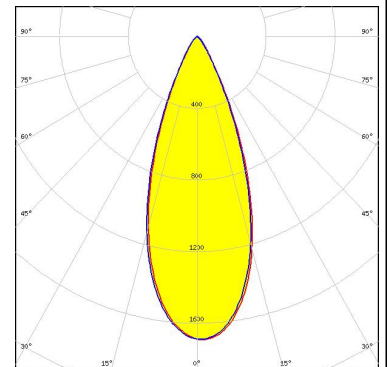

LED NJCWL024Z-V1MT: COB L-Type Tunable White
 FWHM 34.0°
 Efficiency 62 %
 Peak intensity 1.700 cd/lm
 LEDs/each optic 1
 Light colour White
 Required components:
 C16142_HEKLA-SOCKET-K
 Bender Wirth: 497 Typ L8

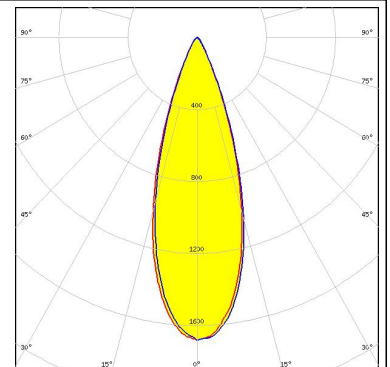
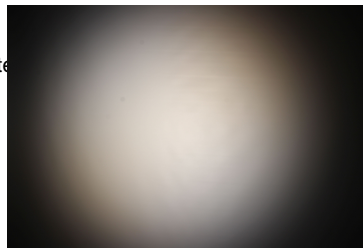

LED NVCWJ024Z-V1MT: COB J-Type Tunable White
 FWHM 42.0°
 Efficiency 61 %
 Peak intensity 1.100 cd/lm
 LEDs/each optic 1
 Light colour White
 Required components:
 C16142_HEKLA-SOCKET-K
 Bender Wirth: 498 Typ L8

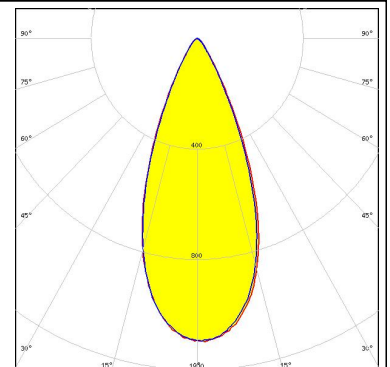
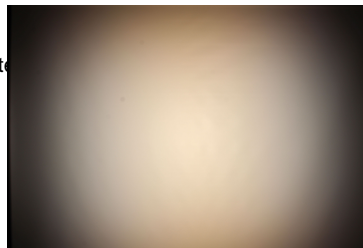

PHOTOMETRIC DATA (MEASURED):

PHILIPS

LED Fortimo SLM L09 CoB
FWHM 45.0°
Efficiency 76 %
Peak intensity 1.330 cd/lm
LEDs/each optic 1
Light colour White
Required components:
F15858_HEKLA-SOCKET-H

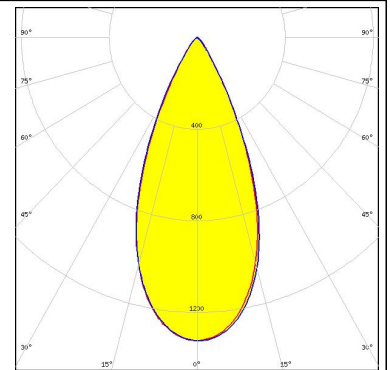

SAMSUNG

LED COB D Series LES 9.8 mm
FWHM 47.0°
Efficiency 77 %
Peak intensity 1.200 cd/lm
LEDs/each optic 1
Light colour White
Required components:

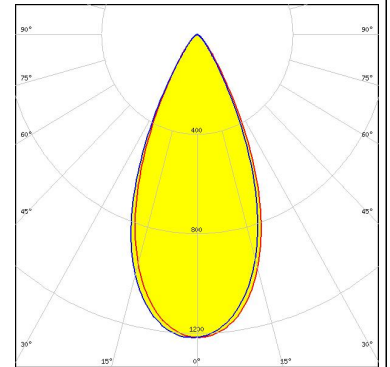
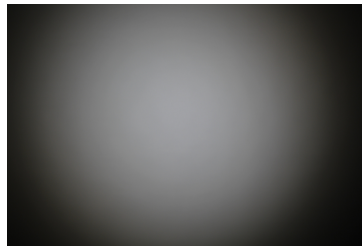

SAMSUNG

LED LC010C G2
FWHM 36.0°
Efficiency 80 %
Peak intensity 2.000 cd/lm
LEDs/each optic 1
Light colour White
Required components:
F15255_HEKLA-SOCKET-C

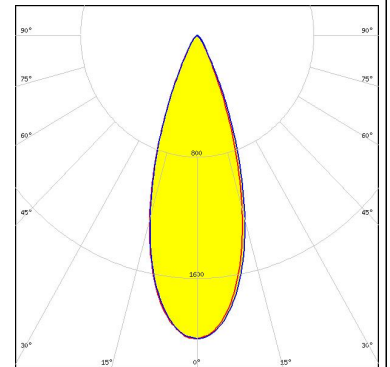
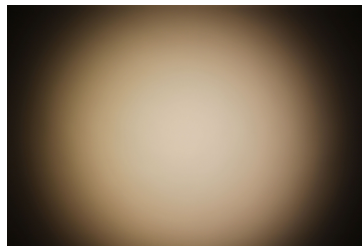

SAMSUNG

LED LC020C G2
FWHM 43.0°
Efficiency 73 %
Peak intensity 1.350 cd/lm
LEDs/each optic 1
Light colour White
Required components:
F15859_HEKLA-SOCKET-I

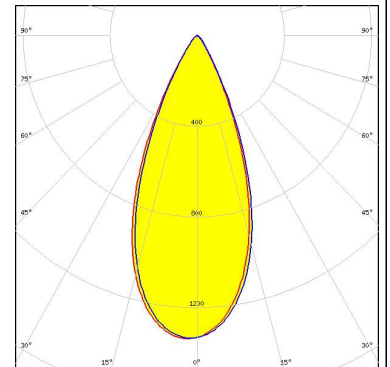

PHOTOMETRIC DATA (MEASURED):

TRIDONIC

LED SLE G7 LES09
FWHM 44.0°
Efficiency 77 %
Peak intensity 1.400 cd/lm
LEDs/each optic 1
Light colour White
Required components:
F15255_HEKLA-SOCKET-C

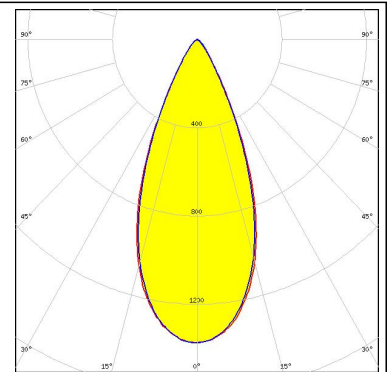
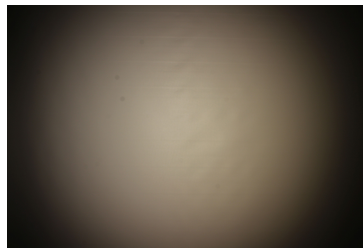

TRIDONIC

LED SLE G7 LES13
FWHM 57.0°
Efficiency 67 %
Peak intensity 0.780 cd/lm
LEDs/each optic 1
Light colour White
Required components:
F15859_HEKLA-SOCKET-I

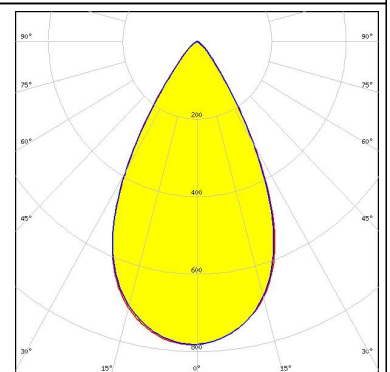
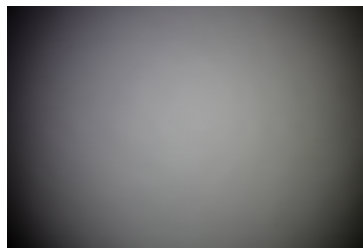

XICATO

LED XOB 6 mm
FWHM 36.0°
Efficiency 78 %
Peak intensity 1.898 cd/lm
LEDs/each optic 1
Light colour White
Required components:
F15255_HEKLA-SOCKET-C

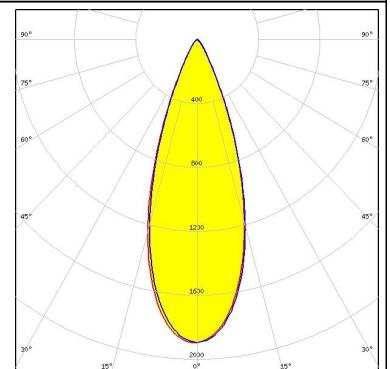
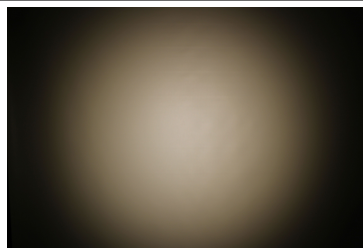

XICATO

LED XOB 9.8 mm
FWHM 44.0°
Efficiency 76 %
Peak intensity 1.324 cd/lm
LEDs/each optic 1
Light colour White
Required components:
F15255_HEKLA-SOCKET-C

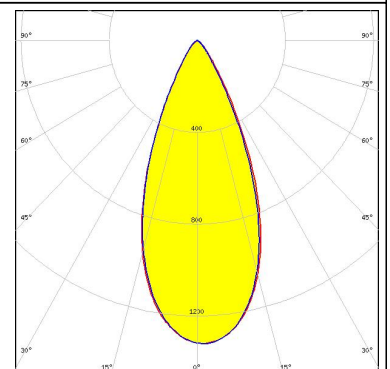
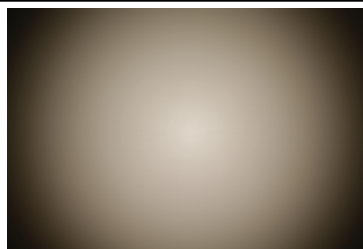

PHOTOMETRIC DATA (SIMULATED):

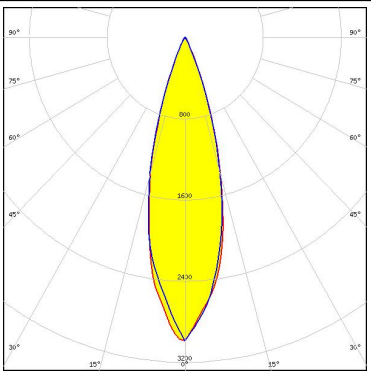
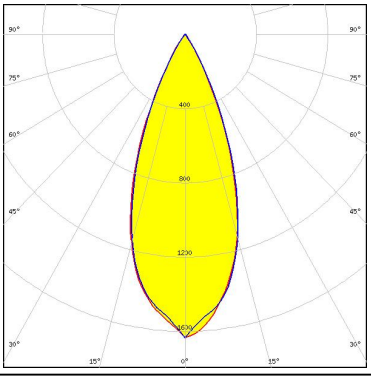
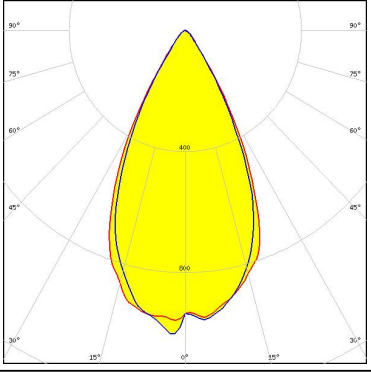
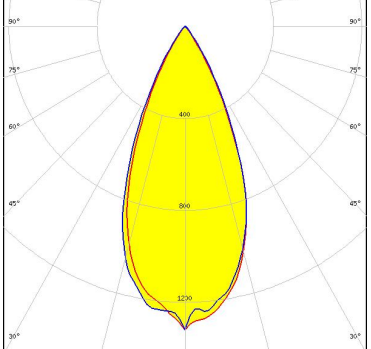
<p>bridgelux.</p> <p>LED V6 Gen6 FWHM 29.0° Efficiency 77 % Peak intensity 3.000 cd/lm LEDs/each optic 1 Light colour White Required components: F15253_HEKLA-SOCKET-A</p>	
<p>bridgelux.</p> <p>LED VERO10 FWHM 40.0° Efficiency 74 % Peak intensity 1.640 cd/lm LEDs/each optic 1 Light colour White Required components: F15616_HEKLA-SOCKET-F</p>	
<p>bridgelux.</p> <p>LED VERO13 FWHM 52.0° Efficiency 73 % Peak intensity 1.000 cd/lm LEDs/each optic 1 Light colour White Required components: C16142_HEKLA-SOCKET-K</p>	
<p>TRIDONIC</p> <p>LED SLE G5 LES11 FWHM 45.0° Efficiency 73 % Peak intensity 1.300 cd/lm LEDs/each optic 1 Light colour White Required components: F15255_HEKLA-SOCKET-C</p>	

PHOTOMETRIC DATA (SIMULATED):

XICATO

LED XTM - 9mm LES
FWHM 42.0°
Efficiency 79 %
Peak intensity 1.640 cd/lm
LEDs/each optic 1
Light colour White
Required components:
C15743_XTM-ADAPTER-50-B

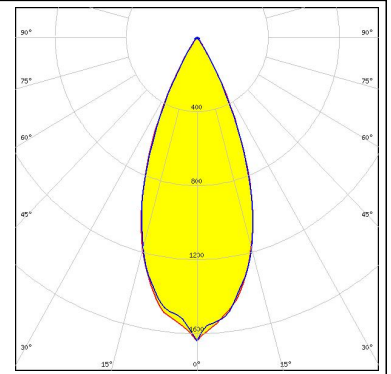

GENERAL INFORMATION:

NOTE: The typical beam angle will be changed by different color, chip size and chip position tolerance. The typical total beam angle is the full angle measured where the luminous intensity is half of the peak value.

Due to use of high power COB's with this product, special attention to proper thermal design is highly recommended. LEDiL has no liability for direct, indirect or consecutive damages arising from the LEDiL products being used outside of the recommended temperature range.

MATERIALS:

As part of our continuous research and improvement processes, and to ensure the best possible quality and availability of our products, LEDiL reserves the right to change material grades without notice.

PRODUCT DATA USER AGREEMENT AND DISCLAIMER:

The measured data in the provided downloadable LEDiL Product Datasheets and Mechanical 2D-Drawings is rounded and provided as reference for planning. LEDiL Oy's optical specifications have been verified by conducting performance testing of the products in accordance with the company's quality system. The reported data are averaged results of multiple measurements with typical variation. LEDiL Oy reserves the right to without prior notification make changes and improvements to its products.

LEDiL Oy assumes neither warranty, nor guarantee nor any other liability of any kind for the contents and correctness of the provided data. The provided data has been generated with highest diligence but the provided data may in reality not represent the complete possible variation range of all intrinsic parameters. Therefore, in certain cases a deviation from the provided data could occur.

LEDiL Oy reserves the right to undertake technical changes of its products without further notification which could lead to changes in the provided data. LEDiL Oy assumes no liability of any kind for the possible deviation from any provided data or any other damage resulting from the usage of the provided data.

The user agrees to this disclaimer and user agreement with the download or usage of the provided files.

LEDiL Oy

Joensuunkatu 13
FI-24240 SALO
Finland

LEDiL Inc.

228 West Page Street
Suite D
Sycamore IL 60178
USA

Local sales and technical support

[www.ledil.com/
where_to_buy](http://www.ledil.com/where_to_buy)

Shipping locations

Salo, Finland
Hong Kong, China

Distribution Partners

[www.ledil.com/
where_to_buy](http://www.ledil.com/where_to_buy)