

GW-7243D

DeviceNet Slave / Modbus Master Gateway

Quick Start User Guide

1. Introduction

This guide introduces users to implement the GW-7243D module into their applications in a quick and easy way. For more detailed information about GW-7243D, please refer to the GW-7243D user manual which is located on the CD-ROM or web site:

[Fieldbus_CD:\DeviceNet\Gateway\GW-7243D\Manual](file:///C:/Fieldbus_CD/DeviceNet/Gateway/GW-7243D/Manual) or

http://www.icpdas.com/products/Remote_IO/can_bus/GW-7243d.htm

2. Configuration Flowchart

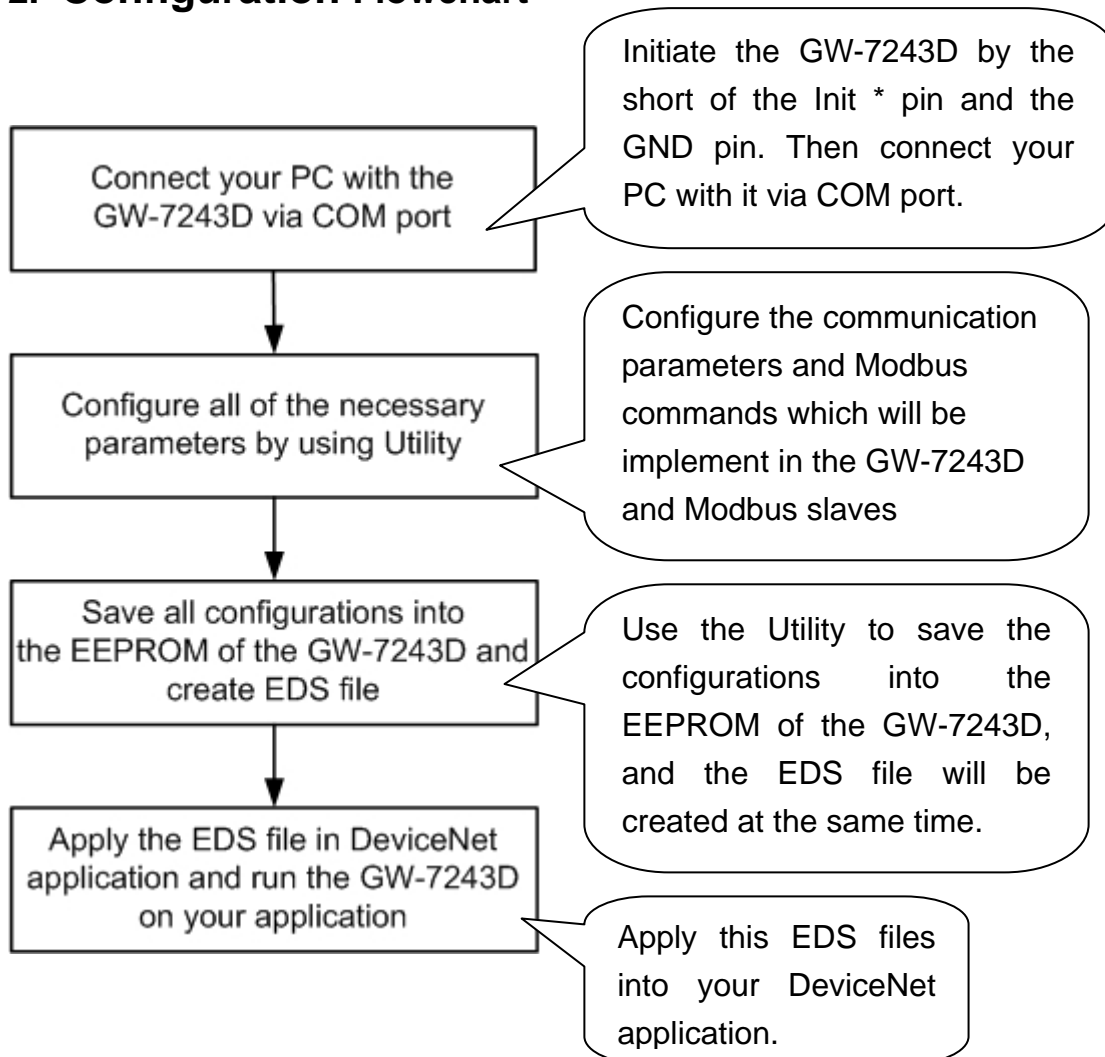

3. Steps to configure the GW-7243D

Step 1: Before configuring the GW-7243D, turn it off. Then connect the INIT* pin with the GND pin of the GW-7243D as following picture. Connect an available COM port of PC with the COM1 of GW-7243D. Then turn on the GW-7243D.

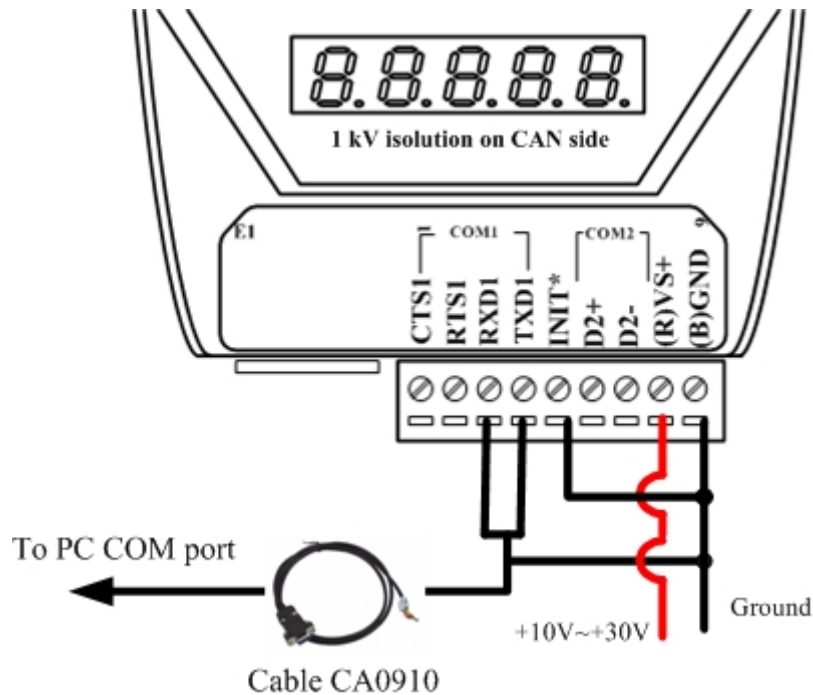

Step 2: Download the GW-7243D Utility setup file from the web site ftp://ftp.icpdas.com.tw/pub/cd/fieldbus_cd/devicenet/gateway/GW-7243D/utility/ or the CD-ROM disk following the path of "/>Fieldbus-CD / DeviceNet / Gateway / GW-7243D / Utility /

Step 3: Execute the setup.exe file to install GW-7243D Utility.

Step 4: After finishing the installation of the GW-7243D Utility, users can find GW-7243D Utility as shown in the following picture.

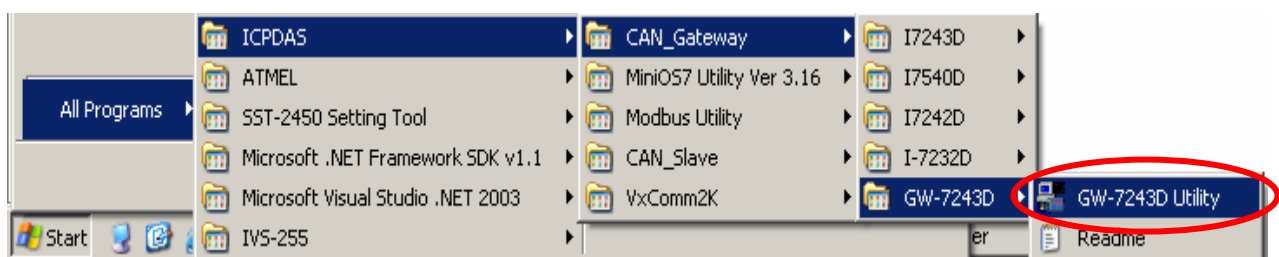

Step 5: Select the COM port of PC which is connected with the COM1 of GW-7243D, and then click the “Connect” button.

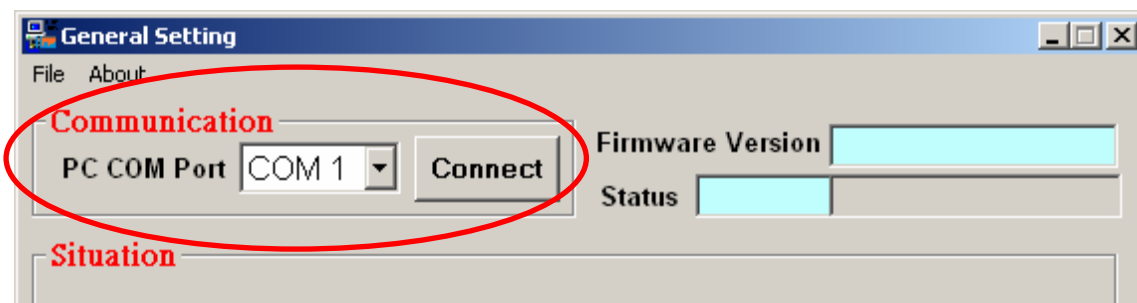

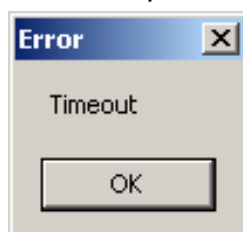

Step 6: If you get an error message during the connection, please check the wire connection described in Step 1. Then try the Step 5 again.

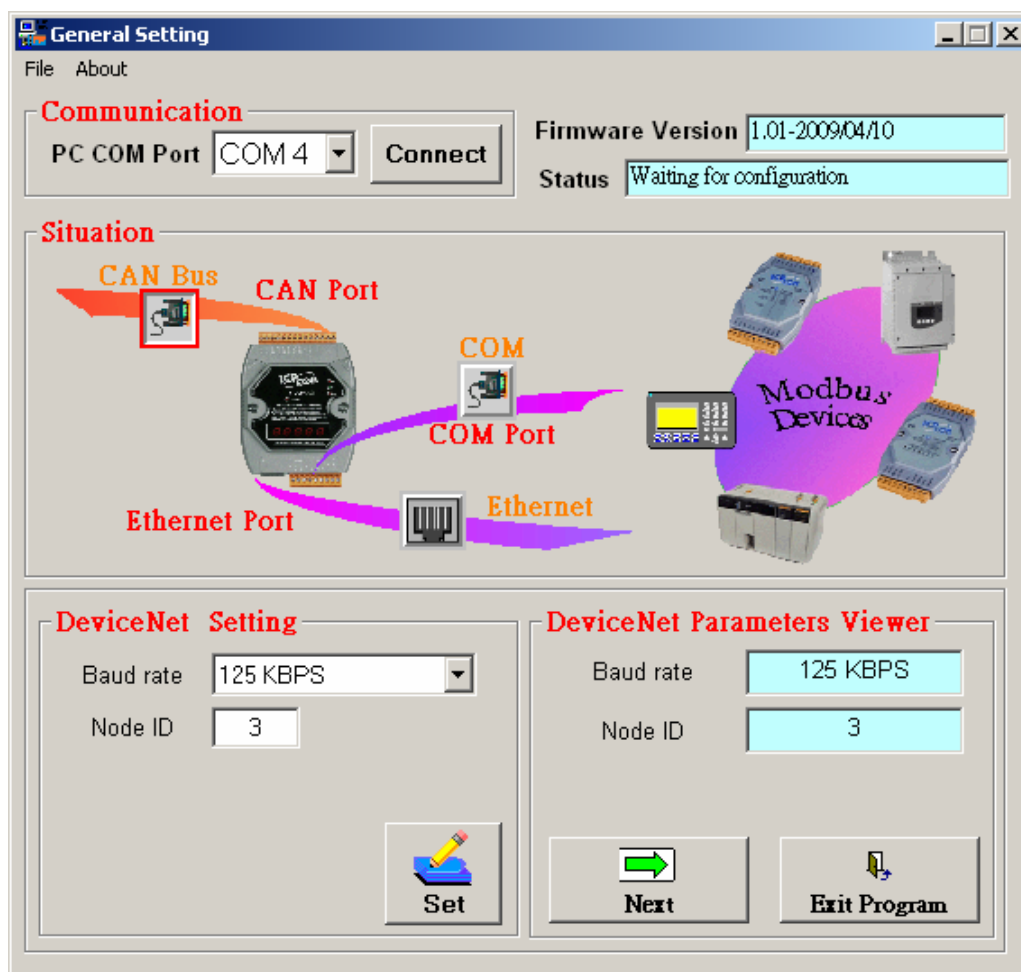

Step 7: If the connection is successful, the screen will be shown as follows.



Step 8: Click the icon  and  to configure the parameters of CAN bus (DeviceNet), COM port and Ethernet. For example, if you want to configure the CAN bus, click the icon  of CAN bus. When you finish the configuration of DeviceNet on the frame of “DeviceNet Setting”, click “Set” button. If configuration is successful, you can see the current configuration on the frame of “DeviceNet Parameters Viewer”. After finishing all of the configuration, click “Next” button.

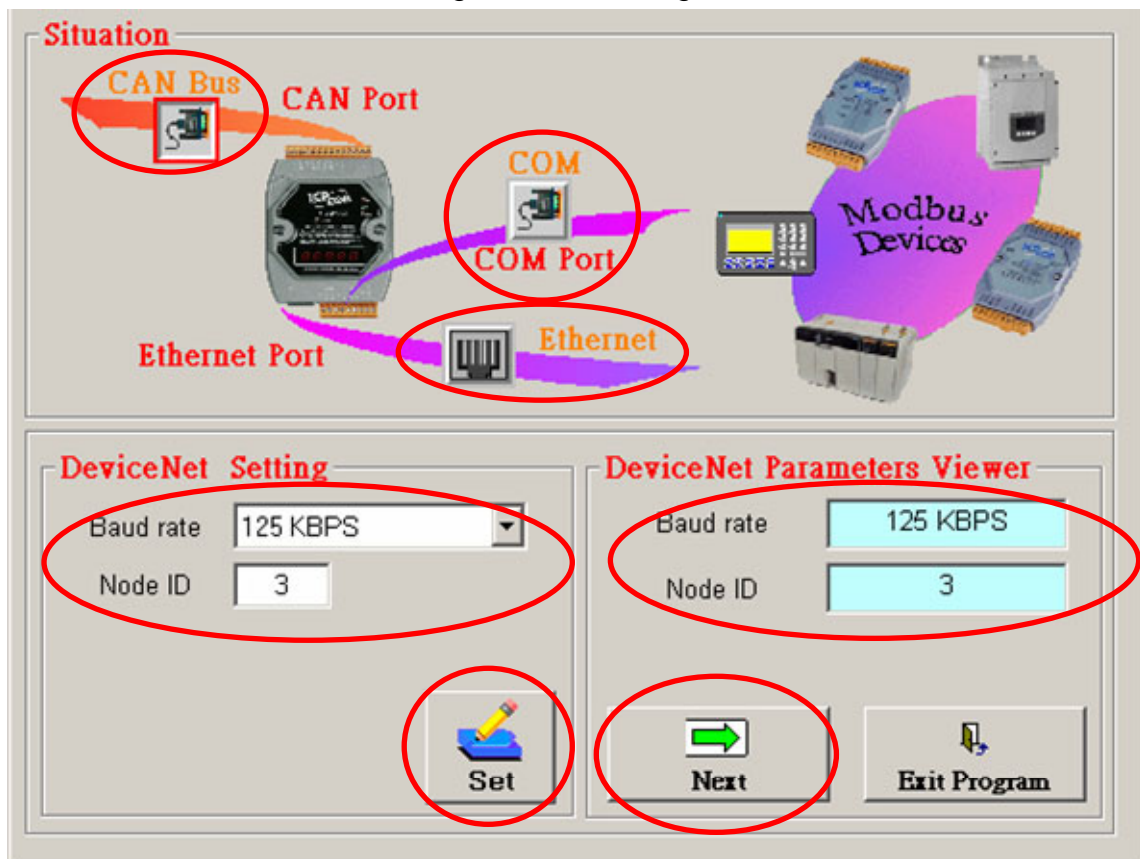

Step 9: There are 6 tabs for Modbus configuration. The COM1/COM2 tab is the configuration of Modbus RTU or Modbus ASCII. The Server01/Server02/Server03/Server04 are the configuration of Modbus TCP. “Class Attributes Setting (0x65)” means that the configuration of COM1 will be saved in the class ID 0x65 of DeviceNet object. Select the tab which you want to configure and go on the next step.

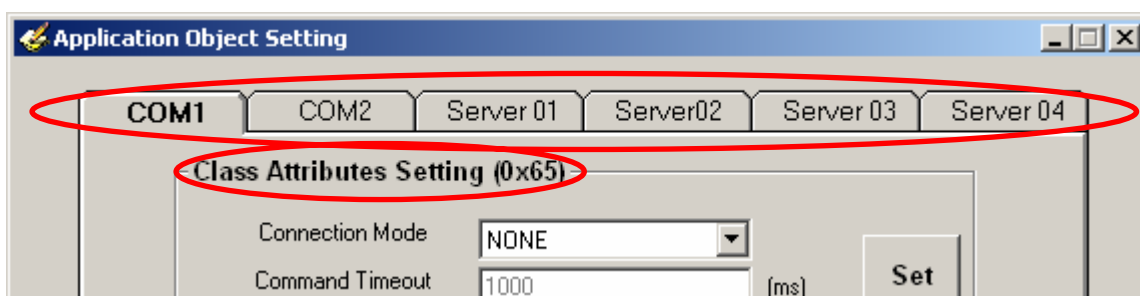

Step 10: Configure “connection mode” and “command timeout” for selected COM port. Select “None” of “connection mode” will disable this COM port. The “Command Timeout” is the response time of the Modbus slave when the GW-7243D queries this slave. When finishing the “Class Attribute Setting”, click “Set” button. In “Instance Attributes Setting” configuration, select “Instance ID” firstly. If the instance exists, users can use “Update”, “Delete” and “Erase” button. If not, only “Add” button can be used. Each instance has its own “Modbus Device Parameters”. The “Modbus Device NetID” is the station No. of the target Modbus slave. The “Modbus Function Code” is the command type which GW-7243D will execute. “Relay Address” and “Data Length (Bits)” are the start address and data length of reading or writing memory of Modbus slave. “Map to Memory Address” is the start channel of GW-7243D storage zone. GW-7243D assigns 6 independent memory blocks for 6 connections (COM1, COM2, Server01, Server02, Server03 and Server04). Each memory block can save 2048 DI channels, 2048 DO channels, 1024 AI channels, and 1024 AO channels. Users need to arrange the proper storage section for each channel in the same IO type. If the storage section of different “Modbus Device Parameters” is overlap, the data will be covered. For example, assume that users set two instances, and the configurations of “Modbus Device Parameters” are as follows:

Instance ID	Modbus Device NetID	Modbus Function Code	Relay Address	Data Length (Bits)	Map to Memory Address
1	1	01	0	16	0
2	2	01	1	32	16

Instance 1 is set to get 16 DO data from the address 0 of Modbus slave with station No. 1. Instance 2 gets 32 DO data from the address 1 of Modbus slave 2. The “Map to Memory Address” of instance 1 is 0. It means that the data of instance 1 will be stored from channel 0 to channel 15 of GW-7243D memory. So, the start channel of memory for instance 2 must be set to 16. If it is set to 15, the last bit of data of instance 1 will be covered by the first bit of data of instance 2. Take a note that the data from Modbus Function code 0x03, 0x06, and 0x10 will be regarded as the data of AO channels. The data from Modbus Function code 0x01, 0x05, and 0x0F will be regarded as the data of DO channels.

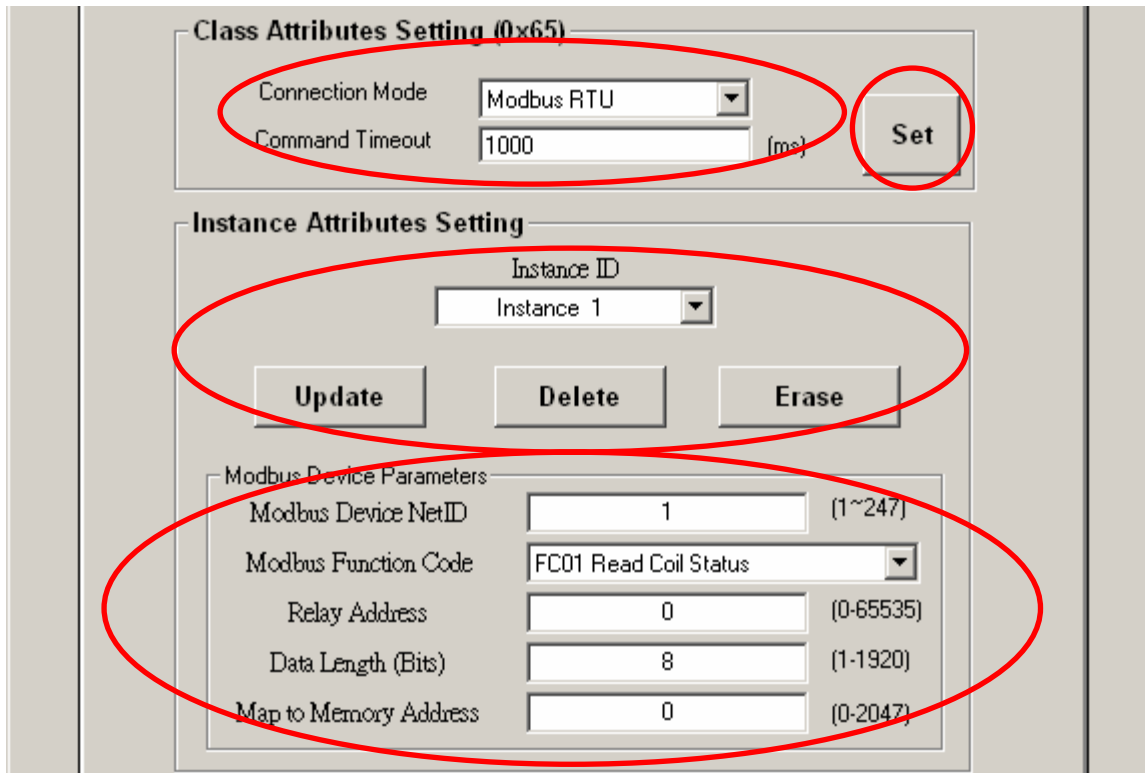

Step 11: The configuration step of the Modbus TCP is similar with Step10. “Connection Valid” can decide if this connection is active or not. “Server IP” is the IP address of the target Modbus slave. “Connection Timeout” is the timeout when GW-7243D built the TCP/IP connection with Modbus slave. “Retry Connection Timeout” is the time period which the GW-7243D reconnects to the Modbus slave if the connection is fail. “Command Timeout” is the response time of the Modbus slave when the GW-7243D queries this slave. After finishing the “Class Attributes Setting”, click “Set” button. The configuration method of “Instance Attributes Setting” configuration is the same as COM port. Please refer to Step 10 for details.

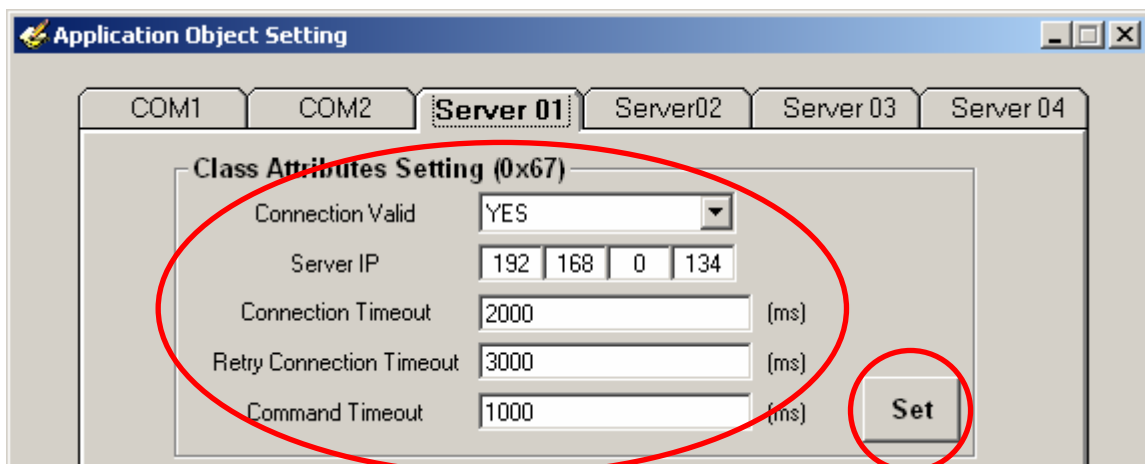

Step12: After finishing all configurations, users can check the configuration result by clicking the “Device View” button and “Object View” button. If everything is OK, click “Next” button to continue.

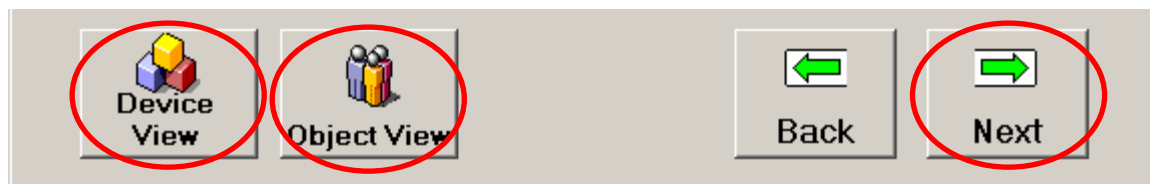

Step13: Fill the “Description” and “Create By” information of EDS file.

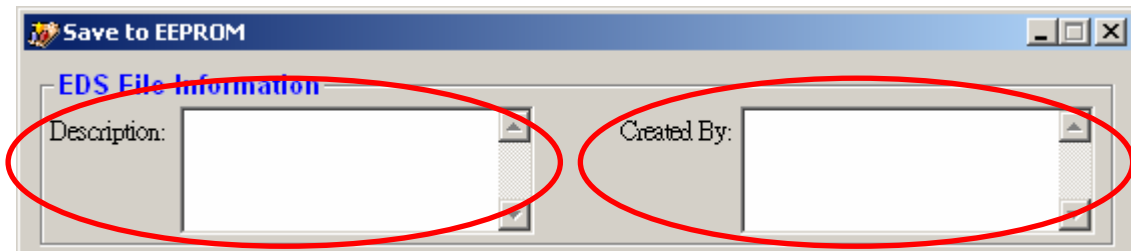

Step14: GW-7243D support Poll IO Connection. “EEPROM Setting” shows the current settings in the EEPROM of the GW-7243D. If you want to use Poll IO Connection, set the connection path in the frame of “Polling IO Connection Path Setting”. Or, just ignore this step. When you want to configure these parameters, select the “CLASS”, “INSTANCE”, and “ATTRIBUTE” from the corresponding combo boxes according to the following table. Only the instance which has been added in the Step 10 and Step 11 can be displayed in the combo box. The Class ID 0x64 is the default connection path. After finishing the settings, click “Set Path” button.

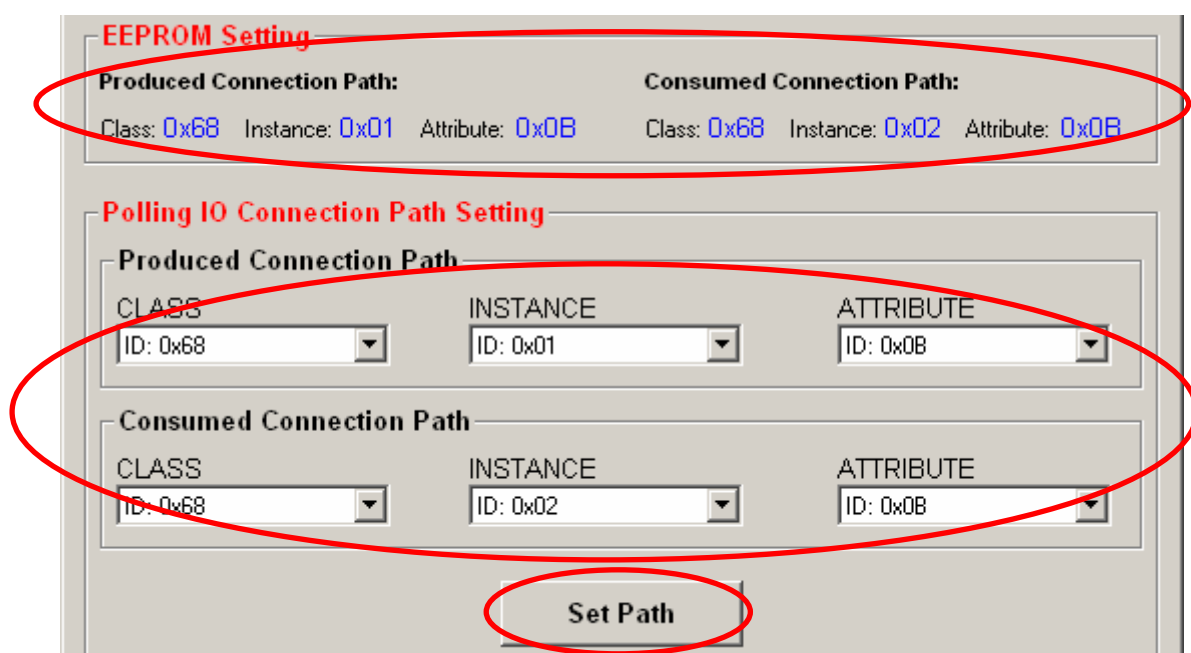

Class ID	Instance ID	Attrib. ID	Description	Method
0x64	0x01	0x01	GW-7243D IP	Get/Set
0x64	0x01	0x02	GW-7243D Gateway	Get/Set
0x64	0x01	0x03	GW-7243D Mask	Get/Set
0x65~0x66	0x01~0x0A	0x0A	Input Discrete Data	Get
0x67~0x6A	0x01~0x05	0x0A	Input Discrete Data	Get
0x65~0x66	0x01~0x0A	0x0B	Coils Status Data	Get/Set
0x67~0x6A	0x01~0x05	0x0B	Coils Status Data	Get/Set
0x65~0x66	0x01~0x0A	0x0C	Input Register Data	Get
0x67~0x6A	0x01~0x05	0x0C	Input Register Data	Get
0x65~0x66	0x01~0x0A	0x0D	Registers Data	Get/Set
0x67~0x6A	0x01~0x05	0x0D	Registers Data	Get/Set

Step14: Afterwards, you can click “Object View” to check all of the configurations set before. If you want to clear the all configurations of the GW-7243D, click “Factory Setting” button. Click “Save” button to save all of the configurations into the EEPROM of the GW-7243D and finish the configurations.



Step 15: Use the EDS file of the GW-7243D in the DeviceNet application. You can find it in the same folder of GW-7243D utility. The default path is “C:\ICPDAS\CAN_Gateway\GW-7243D\”. The file name may be GW-7243D_3.eds. “_3” indicates the DeviceNet Node ID of the GW-7243D that you set in the Step 8.

```

GW-7243D_3.eds - Notepad
File Edit Format View Help
$ ICPDAS-DNS Gateway Electronic Data sheet
$ File Description Section :
$ Created by :
$ Device Information: DeviceNet Slave/Modbus TCP Master Gateway
$ =====
[File]
  DescText   = "ICPDAS DeviceNet I/O Controller ";
  CreateDate = 04:07:2009;           $ created
  CreateTime = 16:37:12;
  ModDate    = 04-07-2009;           $ last changed
  ModTime    = 16:37:12;
  Revision   = 1.0                   $ Revision of EDS

[Device]
  vendCode   = 803;                  $ Vendor Code
  vendName   = "ICPDAS";             $ Vendor Name
  prodType   = 17;                   $ Product Type

```