

## Sensor/actuator cable - SAC-5P-MS/1,5-542/ FSSH SCO BK - 1406132

Please be informed that the data shown in this PDF Document is generated from our Online Catalog. Please find the complete data in the user's documentation. Our General Terms of Use for Downloads are valid (<http://phoenixcontact.com/download>)



Sensor/actuator cable, 5-position, PVC, yellow, shielded, Plug straight M12 SPEEDCON, A-coded, on Socket straight M12 SPEEDCON, A-coded, cable length: 1.5 m



### Key Commercial Data

Packing unit	1 pc
Minimum order quantity	50 pc
GTIN	 4 046356 799171
GTIN	4046356799171

### Technical data

#### Dimensions

Length of cable	1.5 m
-----------------	-------

#### Ambient conditions

Ambient temperature (operation)	-25 °C ... 90 °C (Plug / socket)
Degree of protection	IP65/IP67

#### General

Rated current at 40°C	4 A
Rated voltage	48 V AC 60 V DC
Number of positions	5
Insulation resistance	≥ 100 MΩ
Coding	A - standard
Standards/regulations	M12 connector IEC 61076-2-101
Status display	No
Protective circuit/component	unwired
Overvoltage category	II
Degree of pollution	3

# Sensor/actuator cable - SAC-5P-MS/1,5-542/ FSSH SCO BK - 1406132

## Technical data

### General

Insertion/withdrawal cycles	≥ 100
Torque	0.4 Nm (M12 connector)

### Material

Flammability rating according to UL 94	HB
Contact material	CuSn
Contact surface material	Ni/Au
Contact carrier material	TPU GF
Material of grip body	TPU, hardly inflammable, self-extinguishing
Material, knurls	Zinc die-cast, nickel-plated
Sealing material	NBR

### Standards and Regulations

Standard designation	M12 connector
Standards/regulations	IEC 61076-2-101
Flammability rating according to UL 94	HB

### Cable

Cable type	PVC yellow 105 °C
Cable type (abbreviation)	542
UL AWM style	2517 (105 °C / 300 V)
AWG signal line	22
Conductor structure signal line	30x 1.30 mm
Core diameter including insulation	1.27 mm ±0.03 mm
Wire colors	Brown, blue, black, white, gray
Overall twist	5 wires around filler to the core
Shielding	Tinned copper braided shield
Optical shield covering	85 %
External sheath, color	yellow
External cable diameter D	5.9 mm ±0.2 mm
Minimum bending radius, flexible installation	12 x D
Cable weight	57 kg/km
Outer sheath, material	PVC
Material, filler	PP
Material conductor insulation	PVC
Conductor material	Tin-plated Cu litz wires
Insulation resistance	≥ (550 M Ohms/m @ 500V)
Conductor resistance	max. 50.5 Ω/km (20 °C)
Nominal voltage, cable	300 V
Special properties	UL standards PLTC and ITC
Flame resistance	FT4
Other resistance	UV resistant

# Sensor/actuator cable - SAC-5P-MS/1,5-542/ FSSH SCO BK - 1406132

## Technical data

### Cable

Ambient temperature (operation)	-30 °C ... 105 °C (cable, fixed installation)
	-5 °C ... 105 °C (cable, flexible installation)

### Environmental Product Compliance

China RoHS	Environmentally friendly use period: unlimited = EFUP-e
	No hazardous substances above threshold values

## Drawings

Dimensional drawing

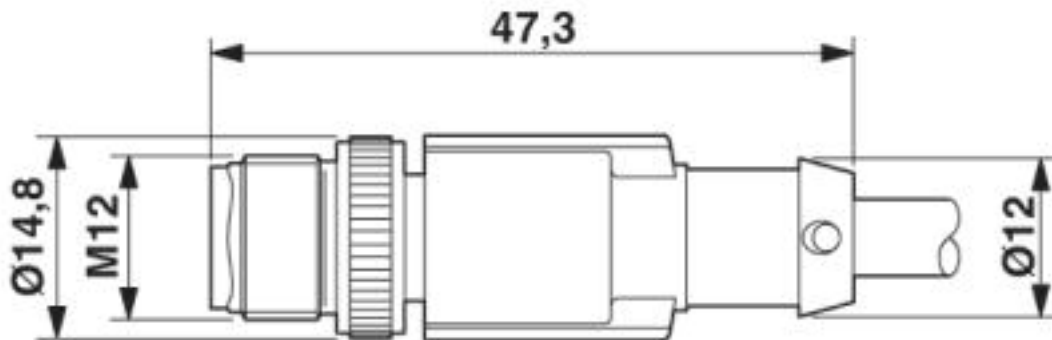

Plug, M12 x 1, straight, shielded

Dimensional drawing

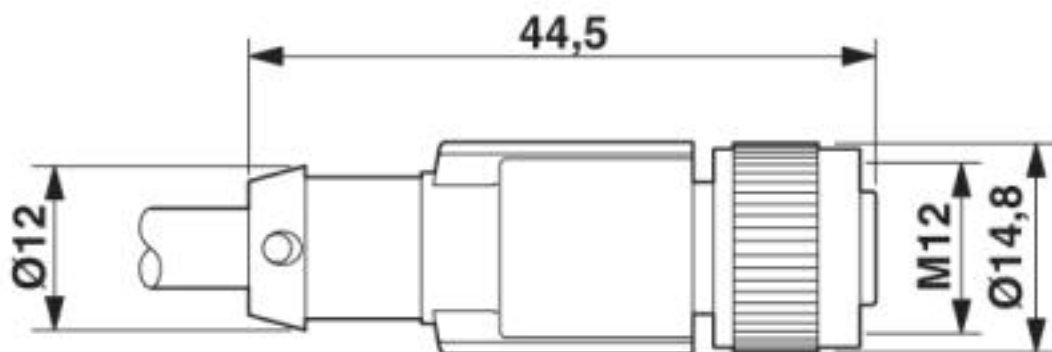

M12 x 1 socket, straight, shielded

## Sensor/actuator cable - SAC-5P-MS/1,5-542/ FSSH SCO BK - 1406132

Circuit diagram

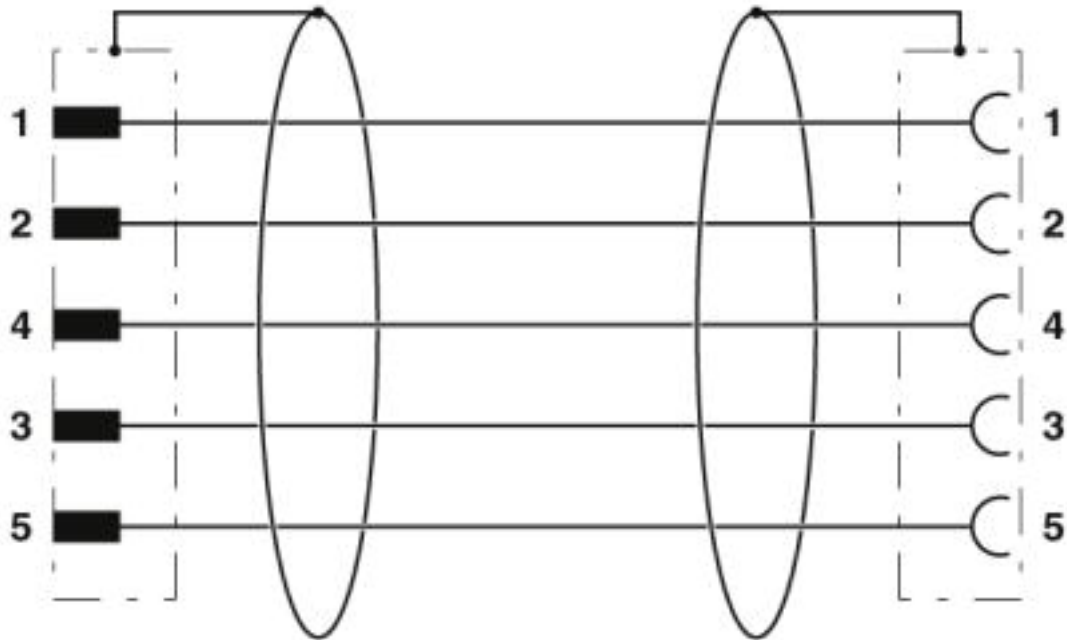

Contact assignment of the M12 plug and the M12 socket

# Sensor/actuator cable - SAC-5P-MS/1,5-542/ FSSH SCO BK - 1406132

Schematic diagram

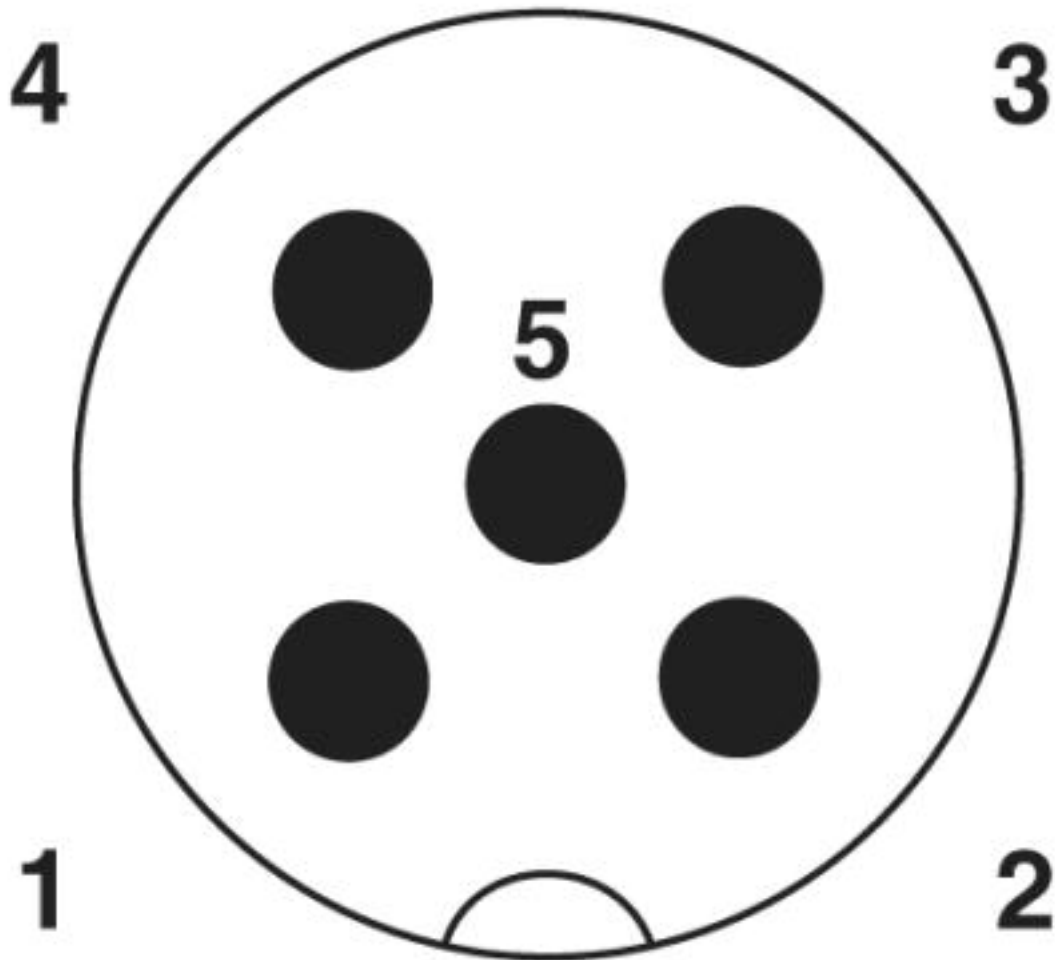

Pin assignment M12 male connector, 5-pos., A-coded, male side

# Sensor/actuator cable - SAC-5P-MS/1,5-542/ FSSH SCO BK - 1406132

Schematic diagram

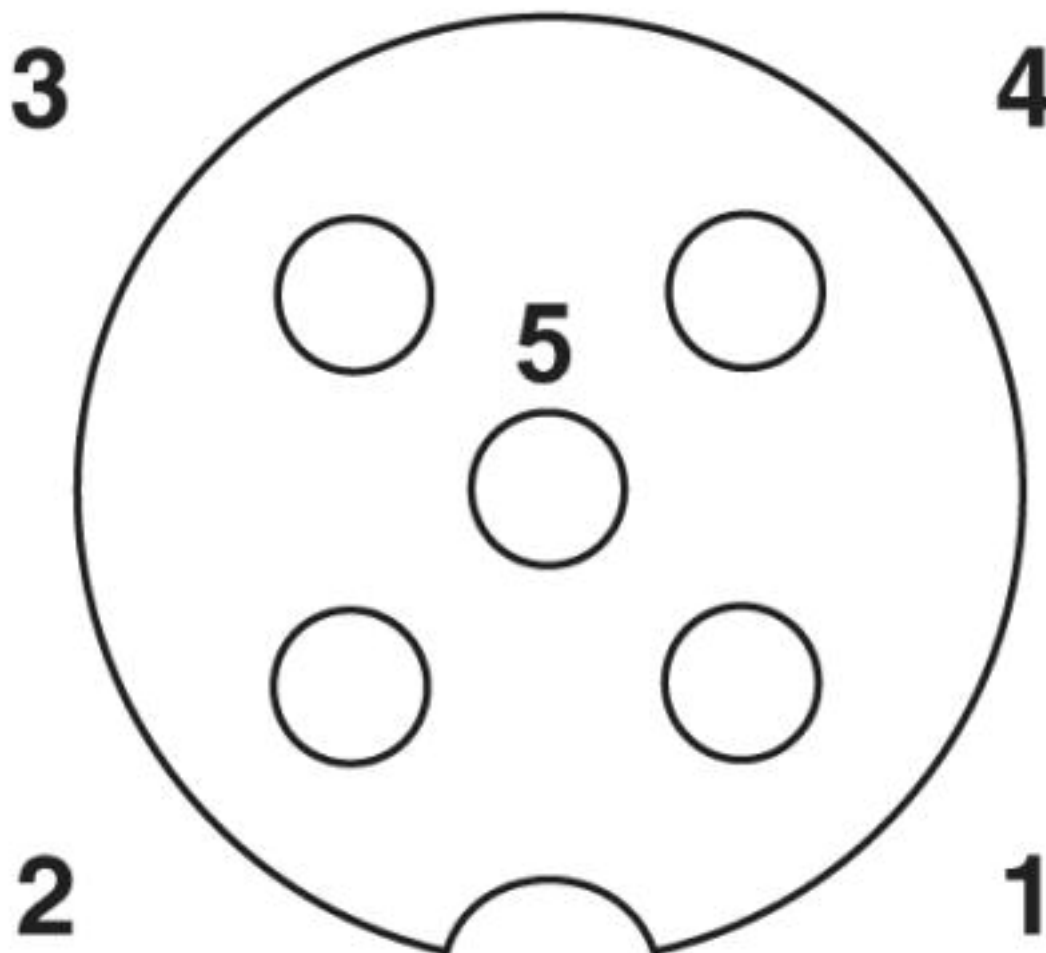

Pin assignment M12 socket, 5-pos., A-coded, socket side view

# Sensor/actuator cable - SAC-5P-MS/1,5-542/ FSSH SCO BK - 1406132

Cable cross section

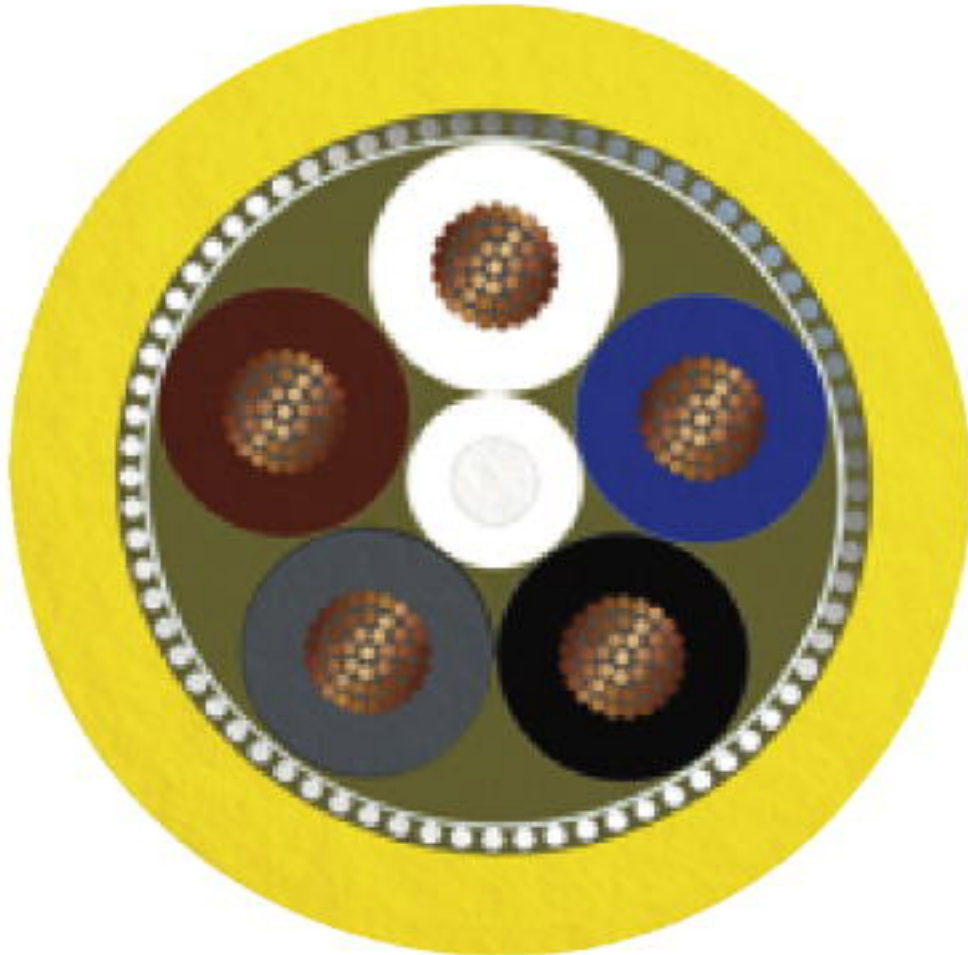

PVC yellow 105 °C [542]

## Approvals

Approvals

---

Approvals

UL Listed / cUL Listed / EAC / cULus Listed

---

Ex Approvals

---

Approval details

# Sensor/actuator cable - SAC-5P-MS/1,5-542/ FSSH SCO BK - 1406132

## Approvals

UL Listed		<a href="http://database.ul.com/cgi-bin/XYV/template/LISEXT/1FRAME/index.htm">http://database.ul.com/cgi-bin/XYV/template/LISEXT/1FRAME/index.htm</a>	FILE E 221474
Nominal voltage UN		125 V	
Nominal current IN		4 A	

cUL Listed		<a href="http://database.ul.com/cgi-bin/XYV/template/LISEXT/1FRAME/index.htm">http://database.ul.com/cgi-bin/XYV/template/LISEXT/1FRAME/index.htm</a>	FILE E 221474
Nominal voltage UN		125 V	
Nominal current IN		4 A	

EAC		RU C- DE.BL08.B.00286
-----	--	--------------------------

cULus Listed	
--------------	---

Phoenix Contact 2019 © - all rights reserved  
<http://www.phoenixcontact.com>

PHOENIX CONTACT GmbH & Co. KG  
 Flachsmarktstr. 8  
 32825 Blomberg  
 Germany  
 Tel. +49 5235 300  
 Fax +49 5235 3 41200  
<http://www.phoenixcontact.com>