

REV.	EN. NO.	DESCRIPTION	SIGN	DATE
C1	N/A	INITIAL DRAWING	Liu	2019/08/13

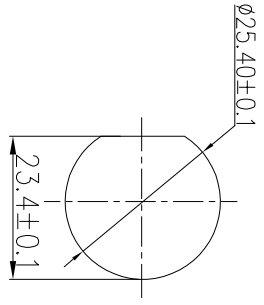

RECOMMENDED PANEL Cut-Out

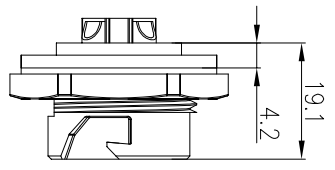

Panel T: Max 2.2

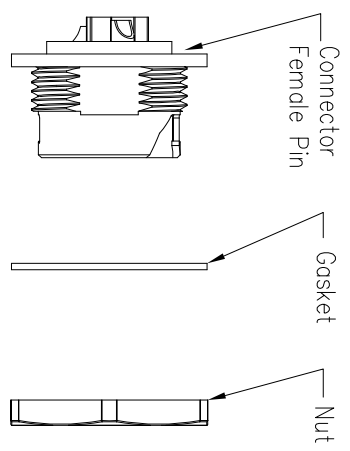
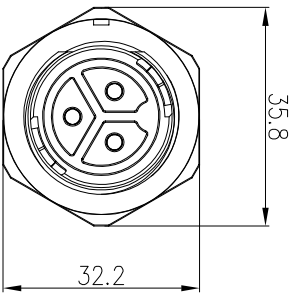
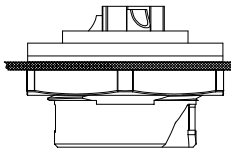

24XXX635-01

Pin Number

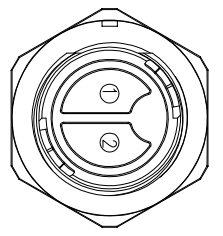

2 Pin

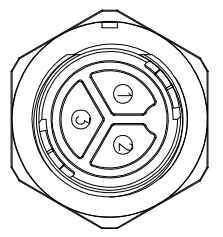

3 Pin

P/N: 24002635-01

P/N: 24003635-01

Pin Assignments Front View

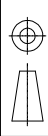

UNIT: mm

TOLERANCE	±0.25
.X	±0.15
.XX	±0.05
.XXX	±0.05
ANGLES	±1°

DESCRIPTION

Large Series Push Lock Front Mount With Female Pin

SCALE	1:1	SHEET	1	OF	1
REV	C1	SIZE	A4	* : Inspection Item	

CHOGORI

PART NO 24XXX635-01

DRAWN BY Liu

DATE 2019/08/13

DWG NO

CHECKED BY Mo

DATE 2019/08/13

CUSTOMER

APPROVED BY Panson

DATE 2019/08/13

- Specification:
1. Operation Temperature: -45°C~105°C.
 2. Insulation Resistance: 100MΩ at DC500V.
 3. Contact Resistance: <math><10m\Omega</math>.
 4. Withstand Voltage: 2000V AC
 5. Operating Current: 20A
 6. Operating Voltage: AC 300V
 7. Waterproof Rate: IP67 (Mated)
 8. Housing: Nylon, Black
 9. Male Pin: Copper Alloy, Gold Plated
 10. Gasket: Silicon Gray
 11. Panel Nut: Nylon, Blue
 12. Torque Rate: 0.8~1.0N•m
 13. RoHS Compliant.
 14. UL Compliant.
 15. Mating Cap P/N: 806-00102-00