

REVISIONS

REV	ECO	DESCRIPTION	DATE	BY	APPR
A1	-	RELEASE DRAWING	30/AUG/21	IAN	TOMMY
A2	-	MODIFICATION TYPICAL WIRE RANGE	15/SEP/21	IAN	TOMMY

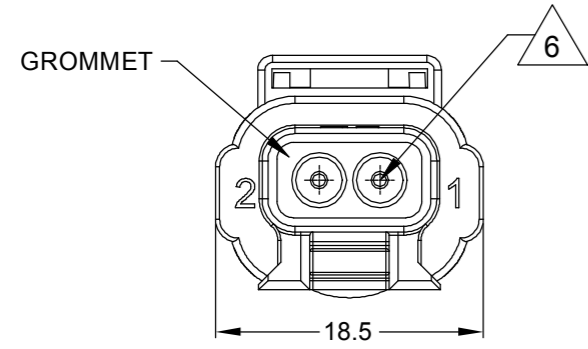
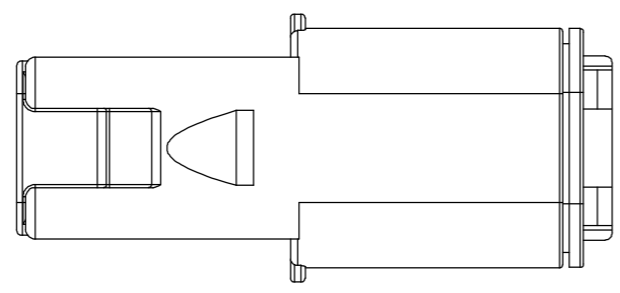
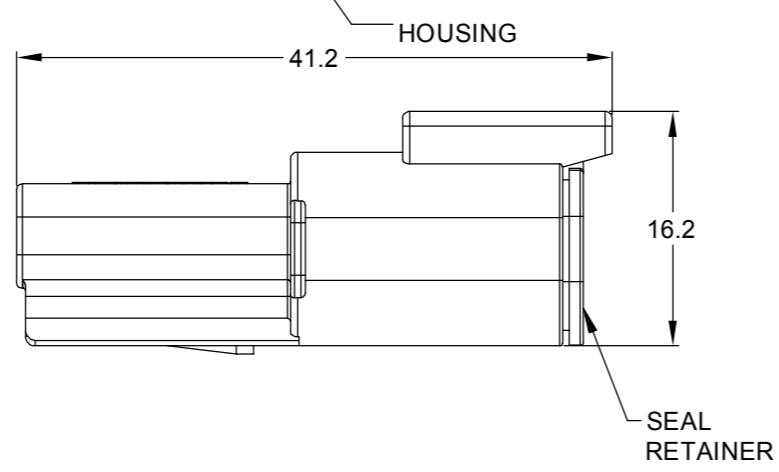
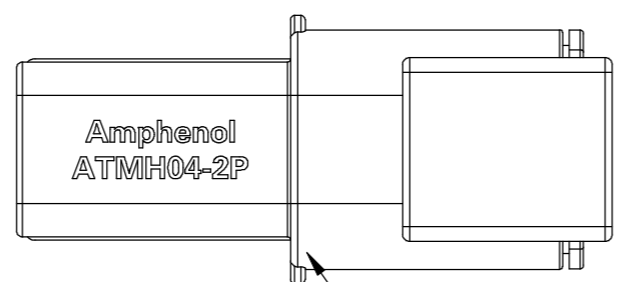
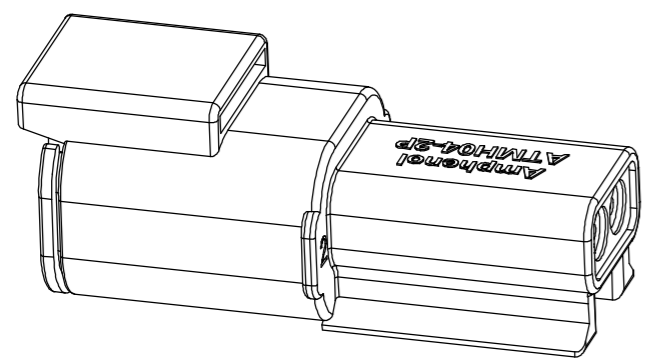

NOTES: UNLESS OTHERWISE SPECIFIED

- MATERIAL:
HOUSING: THERMOPLASTIC, BLACK
INTERFACE SEAL: SILICONE RUBBER, RED
GROMMET: SILICONE RUBBER, RED
SEAL RETAINER: THERMOPLASTIC, BLACK
TERMINAL POSITION ASSURANCE LOCK: THERMOPLASTIC, SEE KEYS ARRANGEMENTS FOR COLOR
- MODIFICATIONS: N/A
- SPECIFICATIONS:
3.1 CURRENT RATING: 7.5 AMPS
3.2 OPERATING TEMPERATURE: -55°C TO +150°C
3.3 DIELECTRIC WITHSTANDING VOLTAGE: LESS THAN 2 MILLIAMPS CURRENT LEAKAGE @ 1500 VOLTS AC.
3.4 INSULATION RESISTANCE: 1000 MEGOHMS MIN @ 25°C.
3.5 MOISTURE RESISTANCE:
IP68(IM OF WATER FOR A PERIOD OF 24 HOURS, MATED CONDITION);
IP69K(MATED CONDITION)
3.6 MATING CYCLE DURABILITY: 100 CYCLES
3.7 RoHS COMPLIANT

4. MATING PART: ATMH06-2SX (X = A,B,C,D KEYS)

5. ALL DIMENSIONS ARE FOR REFERENCE USE ONLY.

6 CONTACT SIZE AND REAR SEAL WIRE RANGE:

CONTACT SIZE	MIN. INSUL O.D.	MAX. INSUL O.D.	TYPICAL WIRE RANGE
20	1.35 mm (.053 in)	3.05 mm (.120 in)	16 - 22 AWG (1.5 - 0.35 mm ²)

7 TERMINAL POSITION ASSURANCE (TPA) LOCK PRE-MOUNTED: AWMH-2PX (X = A,B,C,D KEYS)

KEYS ARRANGEMENTS

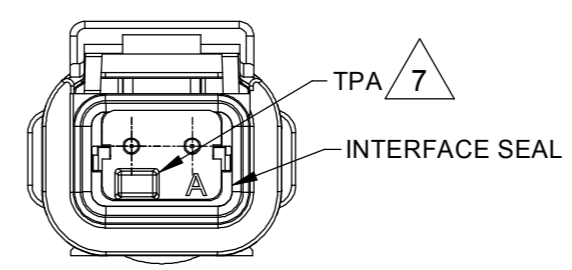

KEY-A CONFIGURATION
ATMH04-2PA
TPA COLOR: GRAY

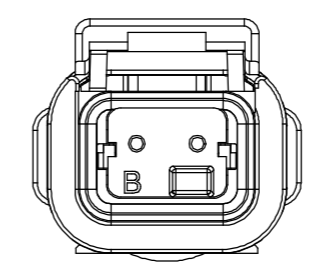

KEY-B CONFIGURATION
ATMH04-2PB
TPA COLOR: BLACK

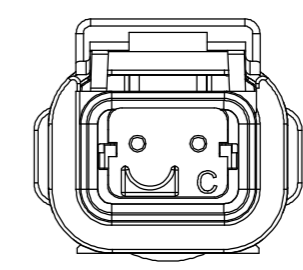

KEY-C CONFIGURATION
ATMH04-2PC
TPA COLOR: GREEN

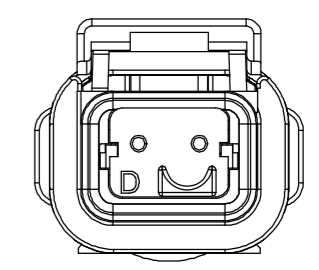

KEY-D CONFIGURATION
ATMH04-2PD
TPA COLOR: BROWN

QUANTITY	PART NUMBER	DESCRIPTION	ITEM
	ATMH04-2PX(SEE KEYS ARRANGEMENTS)	REF:DTMH04-2PA, DTMH04-2PB, DTMH04-2PC, DTMH04-2PD	

SIGNATURES		DATE
DRAWN: IAN	CHECKED: SULLEN	15/SEP/21
ENGINEER:	APPROVAL: TOMMY	16/SEP/21
MATERIAL SPECIFICATIONS:		
PROCESS SPECIFICATIONS:		
NEXT ASSY:		

Amphenol

Sine Systems - www.amphenol-sine.com
44724 Morley Drive
Clinton Township, MI 48036



2 POS, RECEPTACLE, PIN, ATMH SERIES, KEYED, BLACK COLOR

SIZE: B C-	TYPE: NONE	DWG NO: ATMH04-2PX	REVISION: A2
SCALE: NONE		SHEET 1 OF 1	





TITLE: 2 POS, RECEPTACLE, PIN, ATMH SERIES, KEYED, BLACK COLOR
DWG NO: ATMH04-2PX
REV: A2
SH: 1
OF: 1

ATM Series™ - Contact Size 20 Options



Machined Contacts, Sockets & Pins				
Part Number	Description	Size	AWG	Type
AT60-010-2031	Male Contact - Pin, Gold-plated	20	16-18	Machined
AT62-005-20141	Female Contact - Socket, Gold-plated	20	16-18	Machined
AT60-010-20141	Male Contact - Pin, Nickel-plated	20	16-18	Machined
AT62-005-2031	Female Contact - Socket, Nickel-plated	20	16-18	Machined
AT60-202-2031	Male Contact - Pin, Gold-plated	20	20-22	Machined
AT62-201-2031	Female Contact - Socket, Gold-plated	20	20-22	Machined
AT60-202-20141	Male Contact - Pin, Nickel-plated	20	20-22	Machined
AT62-201-20141	Female Contact - Socket, Nickel-plated	20	20-22	Machined

Tooling - Machined Contacts		
Part	Part Number	Description
	CA-5D12	Universal Hand Crimp Tool, Size 12/16/20 (Machined contacts only)
	CA-5E12	Pneumatic Crimp Tool, Size 12/16/20 (Machined contacts only)

Contact Removal Tools		
Part	Part Number	Description
	ATRT-100	Used for removal of contacts for A Series™ products
	AT11-240-2005	Contact Removal Tool, Plastic, Size 20

Sealing Plugs		
Part	Part Number	Description
	AT13-204-2005	Sealing Plug, Size 20, White
	AT13-204-2005-SR	Sealing Plug, Size 20, SR01 Series, Black
	ATM13-217-2005	Locking Sealing Plug, Size 20, Grey
	ATM13-217-2005-SR	Locking Sealing Plug, Size 20, SR01 Series, Blue

Stamped & Formed Contacts, Sockets & Pins				
Part Number	Description	Size	AWG	Type
AT60-20-0144	Male Contact - Pin, Gold-plated	20	16-22	Stamped & Formed
AT62-20-0144	Female Contact - Socket, Gold-plated	20	16-22	Stamped & Formed
AT60-20-0244	Male Contact - Socket, Gold-plated	20	16-22	Stamped & Formed
AT62-20-0244	Female Contact - Socket, Gold-plated	20	16-22	Stamped & Formed
AT60-20-0122	Male Contact - Pin, Nickel-plated	20	16-22	Stamped & Formed
AT62-20-0122	Female Contact - Socket, Nickel-plated	20	16-22	Stamped & Formed
AT60-20-0222	Male Contact - Socket, Nickel-plated	20	16-22	Stamped & Formed
AT62-20-0222	Female Contact - Socket, Nickel-plated	20	16-22	Stamped & Formed
AT60-20-0277	Male Contact - Socket, Tin-plated	20	16-22	Stamped & Formed
AT62-20-0277	Female Contact - Socket, Tin-plated	20	16-22	Stamped & Formed
AT60-20-0422	Male Contact - Socket, Nickel-plated	20	20-22	Stamped & Formed
AT62-20-0444	Female Contact - Socket, Gold-plated	20	20-22	Stamped & Formed

Tooling - Stamped & Formed Contacts		
Part	Part Number	Description
	MFx-3974	Crimp Die - Size 20 (S&F contacts only)
	MFx-3976	Crimp Die - Size 20 (S&F contacts only) 20-22AWG -04XX Series
	MFx-3978	Crimp Die - Size 20 (S&F contacts only) 20-22AWG -02XX Series
	ATT-20-00	Hand Crimp Tool - Size 20, 20AWG (S&F contacts only)