

STRADA-T-DN

Beam for area lighting with shorter illumination distances optimized for CREE XP-G and XP-E. Assembly with installation tape.

TECHNICAL SPECIFICATIONS:

| | |
|----------------|------------------|
| Dimensions | 19.6 x 15.5 mm |
| Height | 8.8 mm |
| Fastening | tape, pin, screw |
| ROHS compliant | yes ⓘ |



MATERIAL SPECIFICATIONS:

| Component | Type | Material | Colour | Finish |
|--------------------|-------------|----------|--------|--------|
| STRADA-T-DN | Single lens | PMMA | clear | |
| VOSU-WU-M-365-TAPE | Tape | | | |

ORDERING INFORMATION:

| Component | Type | Qty in box | MOQ | MPQ | Box weight (kg) |
|--------------------------------|-------------|------------|-----|-----|-----------------|
| CA11416_STRADA-T-DN | Single lens | 3360 | 240 | 240 | 5.6 |
| » Box size: 451 x 273 x 197 mm | | | | | |

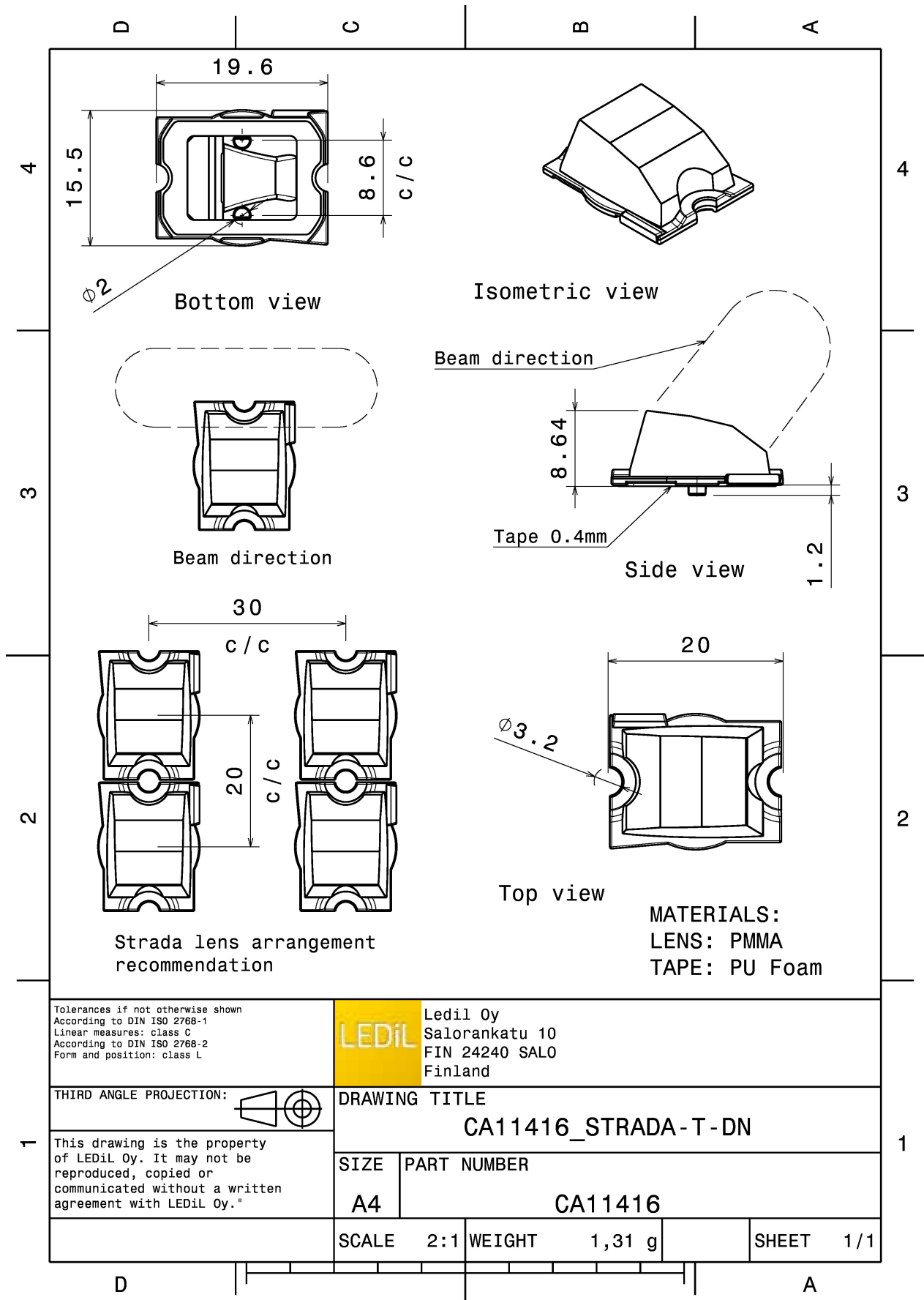

Tolerances if not otherwise shown
According to DIN ISO 2768-1
Linear measures: class C
According to DIN ISO 2768-2
Form and position: class L



Ledil Oy
Salorankatu 10
FIN 24240 SALO
Finland

THIRD ANGLE PROJECTION:

DRAWING TITLE

CA11416_STRADA-T-DN

This drawing is the property of LEDiL Oy. It may not be reproduced, copied or communicated without a written agreement with LEDiL Oy."

SIZE PART NUMBER

A4

CA11416

SCALE 2:1 WEIGHT 1,31 g

SHEET 1/1

See also our general installation guide: www.ledil.com/installation_guide

PHOTOMETRIC DATA (MEASURED):



LED XB-D
FWHM / FWTM Asymmetric
Efficiency 91 %
LEDs/each optic 1
Light colour White
Required components:

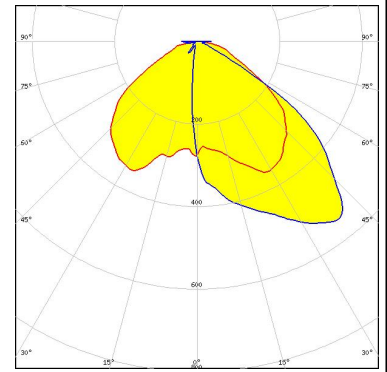

LED XP-E
FWHM / FWTM Asymmetric
Efficiency 92 %
LEDs/each optic 1
Light colour White
Required components:



LED XP-G
FWHM / FWTM Asymmetric
Efficiency 92 %
LEDs/each optic 1
Light colour White
Required components:



LED LUXEON A
FWHM / FWTM Asymmetric
Efficiency 92 %
LEDs/each optic 1
Light colour White
Required components:

PHOTOMETRIC DATA (MEASURED):

LUMILEDS

LED LUXEON Rebel
FWHM / FWTM Asymmetric
Efficiency 92 %
LEDs/each optic 1
Light colour White
Required components:

LUMILEDS

LED LUXEON Rebel ES
FWHM / FWTM Asymmetric
Efficiency 92 %
LEDs/each optic 1
Light colour White
Required components:

LUMILEDS

LED LUXEON TX
FWHM / FWTM Asymmetric
Efficiency 91 %
Peak intensity 0.5 cd/lm
LEDs/each optic 1
Light colour White
Required components:

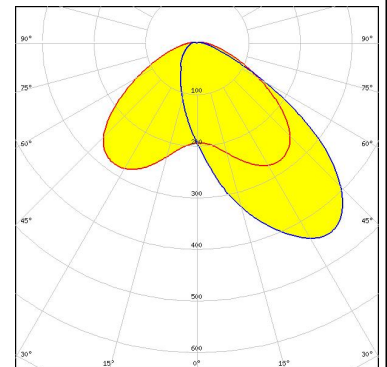



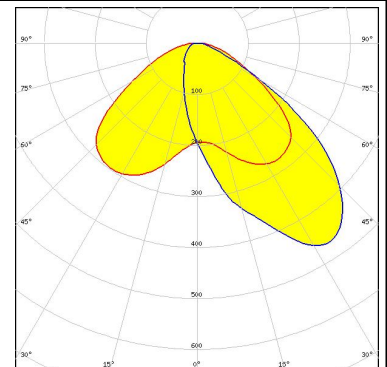

LUMILEDS

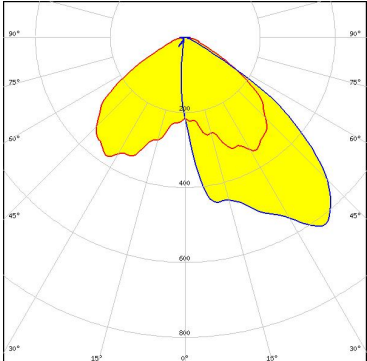

LED LUXEON Z ES
FWHM / FWTM Asymmetric
Efficiency 90 %
Peak intensity 0.5 cd/lm
LEDs/each optic 1
Light colour White
Required components:

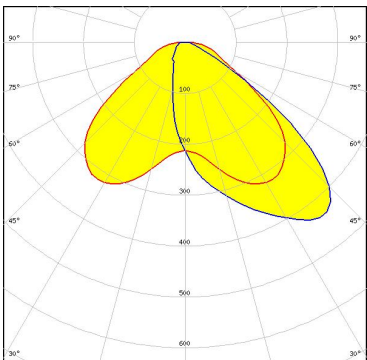

PHOTOMETRIC DATA (MEASURED):

| | |
|---|---|
| <p>NICHIA</p> <p>LED: NCSxx19A FWHM / FWTM: Asymmetric Efficiency: 92 % LEDs/each optic: 1 Light colour: White Required components:</p> |  |
| <p>NICHIA</p> <p>LED: NVSxx19A FWHM / FWTM: Asymmetric Efficiency: 92 % LEDs/each optic: 1 Light colour: White Required components:</p> |  |
| <p>OSRAM Opto Semiconductors</p> <p>LED: OSLOM Square PC FWHM / FWTM: Asymmetric Efficiency: 93 % LEDs/each optic: 1 Light colour: White Required components:</p> |  |
| <p>OSRAM Opto Semiconductors</p> <p>LED: OSLOM SSL 150 FWHM / FWTM: Asymmetric Efficiency: 92 % LEDs/each optic: 1 Light colour: White Required components:</p> |  |

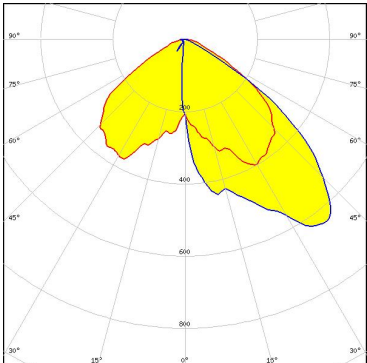
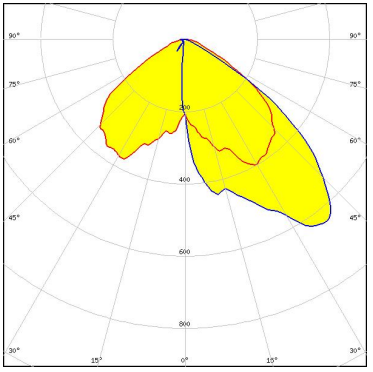
PHOTOMETRIC DATA (MEASURED):

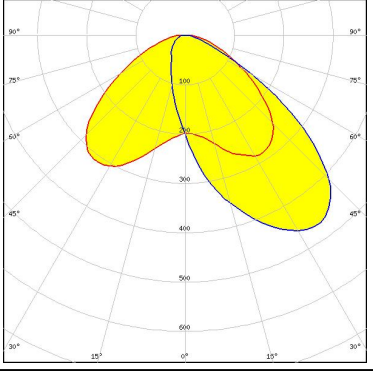
| | |
|--|--|
| <p> SEOUL SEMICONDUCTOR</p> <p>LED Z5 FWHM / FWTM Asymmetric Efficiency 92 % LEDs/each optic 1 Light colour White Required components:</p> |  |
| <p> SEOUL SEMICONDUCTOR</p> <p>LED Z5M1/Z5M2 FWHM / FWTM Asymmetric Efficiency 92 % Peak intensity 0.5 cd/lm LEDs/each optic 1 Light colour White Required components:</p> |  |
| <p>SHARP</p> <p>LED Double Dome (GM2BB) FWHM / FWTM Asymmetric Efficiency 92 % LEDs/each optic 1 Light colour White Required components:</p> | |

PHOTOMETRIC DATA (SIMULATED):

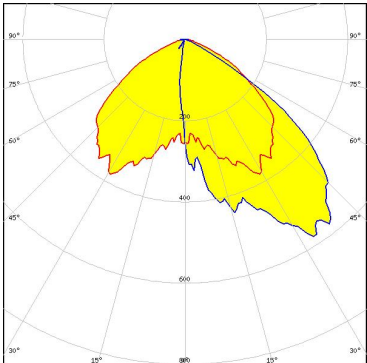
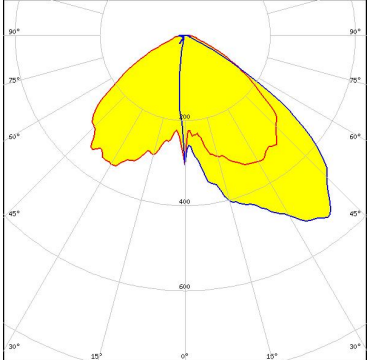
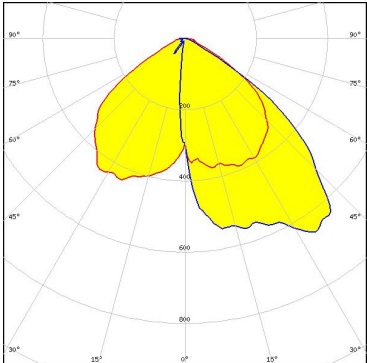
| | |
|--|---|
| <p>LUMILEDS</p> <p>LED: LUXEON T FWHM / FWTM: Asymmetric Efficiency: 91 % LEDs/each optic: 1 Light colour: White Required components:</p> |  |
| <p>NICHIA</p> <p>LED: NVSxx19B/NVSxx19C FWHM / FWTM: Asymmetric Efficiency: 90 % LEDs/each optic: 1 Light colour: White Required components:</p> |  |
| <p>OSRAM <small>Opto Semiconductors</small></p> <p>LED: OSOLON SSL 80 FWHM / FWTM: Asymmetric Efficiency: 93 % Peak intensity: 0.7 cd/lm LEDs/each optic: 1 Light colour: White Required components:</p> |  |

GENERAL INFORMATION:

NOTE: The typical beam angle will be changed by different color, chip size and chip position tolerance. The typical total beam angle is the full angle measured where the luminous intensity is half of the peak value.

MATERIALS:

As part of our continuous research and improvement processes, and to ensure the best possible quality and availability of our products, LEDiL reserves the right to change material grades without notice.

PRODUCT DATA USER AGREEMENT AND DISCLAIMER:

The measured data in the provided downloadable LEDiL Product Datasheets and Mechanical 2D-Drawings is rounded and provided as reference for planning. LEDiL Oy's optical specifications have been verified by conducting performance testing of the products in accordance with the company's quality system. The reported data are averaged results of multiple measurements with typical variation. LEDiL Oy reserves the right to without prior notification make changes and improvements to its products.

LEDiL Oy assumes neither warranty, nor guarantee nor any other liability of any kind for the contents and correctness of the provided data. The provided data has been generated with highest diligence but the provided data may in reality not represent the complete possible variation range of all intrinsic parameters. Therefore, in certain cases a deviation from the provided data could occur.

LEDiL Oy reserves the right to undertake technical changes of its products without further notification which could lead to changes in the provided data. LEDiL Oy assumes no liability of any kind for the possible deviation from any provided data or any other damage resulting from the usage of the provided data.

The user agrees to this disclaimer and user agreement with the download or usage of the provided files.

LEDiL Oy

Joensuunkatu 13
FI-24240 SALO
Finland

LEDiL Inc.

228 West Page Street
Suite D
Sycamore IL 60178
USA

Ledil Optics Technology (Shenzhen) Co., Ltd.

405 , Block B
Casic Motor Building
Shenzhen 518057
P.R.CHINA

Local sales and technical support

[www.ledil.com/
where_to_buy](http://www.ledil.com/where_to_buy)

Shipping locations

Salo, Finland
Hong Kong, China

Distribution Partners

[www.ledil.com/
where_to_buy](http://www.ledil.com/where_to_buy)