

Click [here](#) for production status of specific part numbers.

MAX14813 Evaluation Kit

Evaluates: MAX14813

General Description

The MAX14813 evaluation kit (EV kit) provides a proven design to evaluate the MAX14813 high-voltage, high-frequency, three-level octal/five-level quad pulser. It also provides the capability to control the MAX14813 through an onboard USB-to-SPI interface, on-board high-frequency clock generator and synchronous trigger. The EV kit includes a graphical user interface (GUI) for exercising the beam forming features of the IC, making it a complete PC-based evaluation system.

EV Kit Contents

- MAX14813EVKIT# including the MAX14813EWX+
- USB Cable Type A Male to Type B Male

Benefits and Features

- Easy Evaluation of the MAX14813
- Configurable for Three-Level or Five-Level Mode
- Programmable Master Clock Frequency and Trigger
- Option for External Clock and External Trigger
- Includes 3.5mm Scope-Probe Jacks for High-Voltage Outputs
- Windows XP®, Windows® 7, Windows 8.1, Windows 10-Compatible Software
- Fully Assembled and Tested
- Proven PCB Layout
- RoHS Compliant

[Ordering Information](#) appears at end of data sheet.

MAX14813 EV Kit Photo

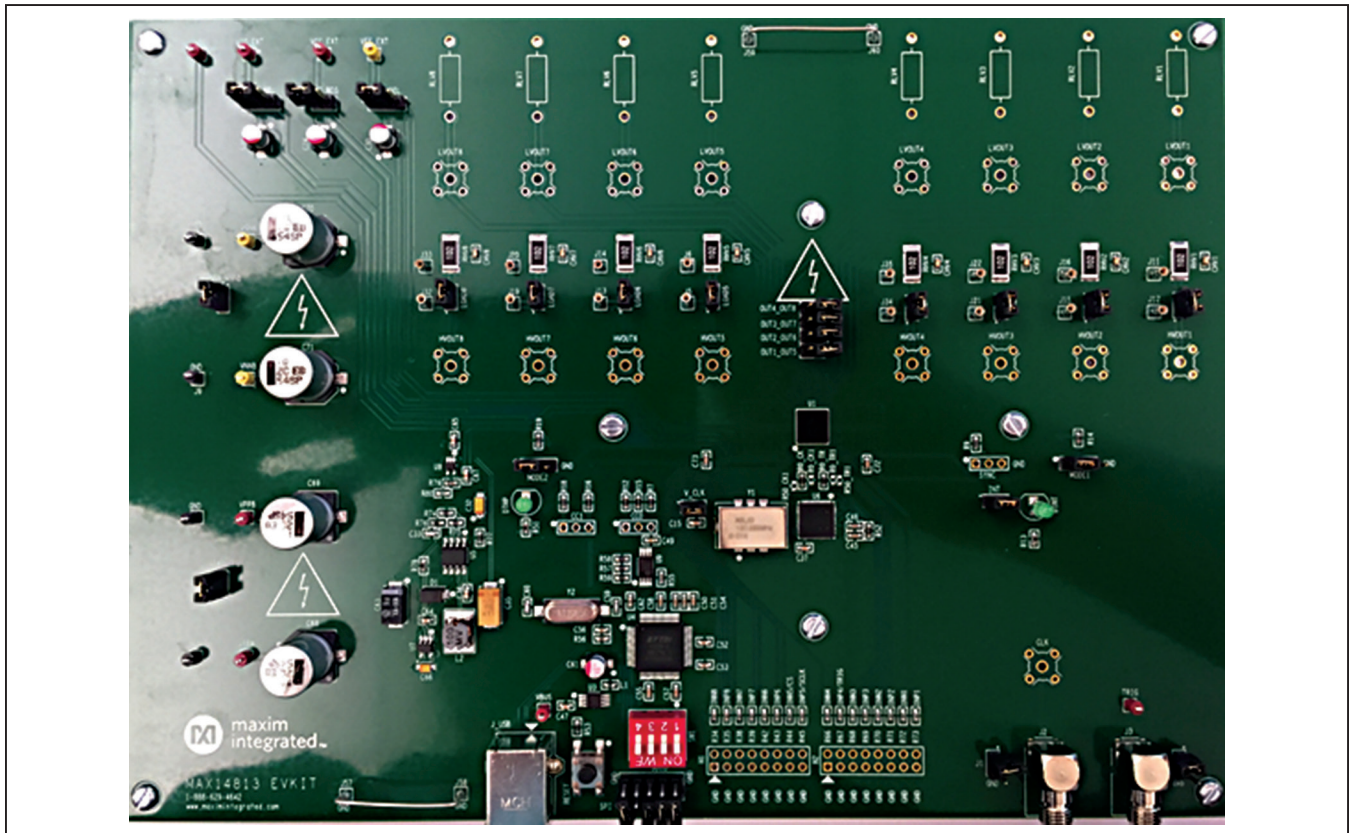

Windows and Windows XP are registered trademarks and registered service marks of Microsoft Corporation.



System Block Diagram

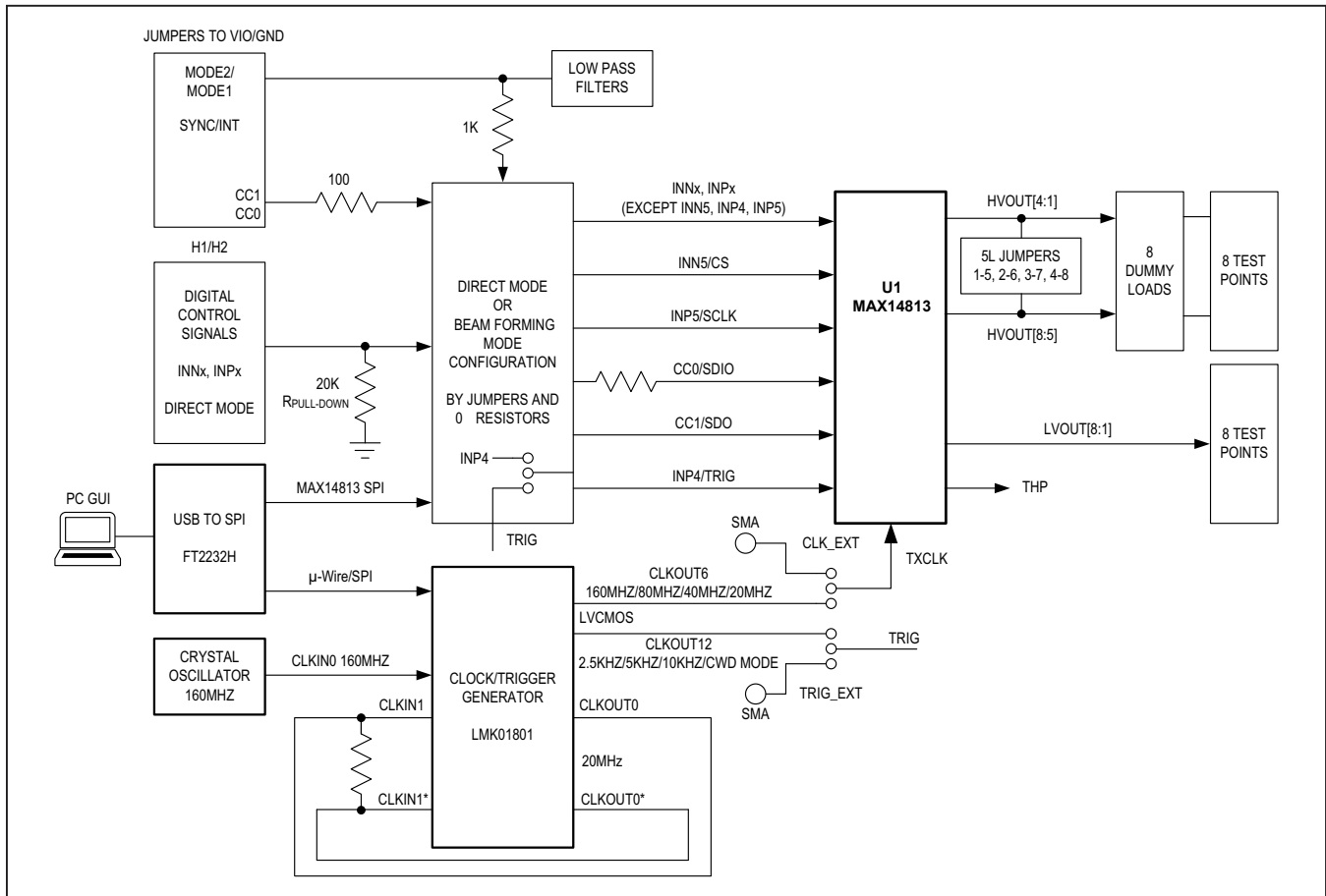

MAX14318 EV Kit Files

FILE	DESCRIPTION
MAX14813EVMSetupV1.0.ZIP	Application Program

Quick Start

Required Equipment

- MAX14813 EV kit
- Type A Male to Type B Male USB Cable
- Optional custom controller board or pattern generator to drive the INN1-INN8, INP1-INP8 control signals (see the MAX14813 IC data sheet for more information)
- +3.3V DC, 100mA power supply (optional if the on-board LDO is used)
- +5V DC, 1A power supply

- -5V DC, 0.5A power supply (optional if the on-board LDO is used)
- +5V to +100V DC, 30mA (+100V) to 600mA (+5V) power supply
- -5V to -100V DC, -30mA (-100V) to -600mA (-5V) power supply
- Optional (for 5 levels configuration) +5V to +100V DC, 30mA (+100V) to 600mA (+5V) power supply
- Optional (for 5 levels configuration) -5V to -100V DC, -30mA (-100V) to -600mA (-5V) power supply
- Digital storage oscilloscope

It is recommended that the engineer read the MAX14813 IC data sheet prior to using the EV kit and GUI.

Note: In the following sections, software-related items are identified by bolding. Text in **bold** refers to items directly from the EV kit software. Text in **bold and underline** refers to items from the Windows operating system.

Procedure

The EV kit is fully assembled and tested. Follow the steps below to verify MAX14813 EV kit operation:

- 1) Visit www.maximintegrated.com/evkitsoftware to download the latest version of the EV kit software, MAX14813EVKitSetupV1.0.ZIP.
- 2) Save the EV kit software to a temporary folder and uncompress the ZIP file.
- 3) Install the EV kit software and USB driver on your computer by running the MAX14813EVKitSetupV1.0.exe program inside the temporary folder. A message box asking **Do you want to allow the following program to make changes to this computer?** may appear. If so, click **Yes**.
- 4) The program files are copied to your PC and icons are created in the Windows **Start | Programs** menu. At the end of the installation process, the installer will launch the installer for the FTDI Chip CDM drivers.
- 5) The installer includes the drivers for the hardware and software. Follow the instructions on the installer and

- once complete, click **Finish**. The default location of the software is in the program files directory.
- 6) Connect the EV kit to the PC with the USB cable. Windows should automatically recognize the device, install the driver and display a message near the **System Icon** menu indicating that the hardware is ready to use.
 - 7) Once the hardware is ready to use, launch the EV kit software by opening its icon in the **Start | Programs** menu. The EV kit software appears as shown in [Figure 1](#). The EV kit software will automatically connect to the EV kit hardware and lower-right status bar should indicate **“MAX14813 EV Kit Hardware Connected”**. Otherwise from the **Device** menu select **Connect Hardware**. Verify that the lower-right status bar indicates the EV kit hardware is **Connected**.

The EV kit is ready to be tested for **Beam Forming** evaluation. To use it in **Direct** mode, please note that you have to change a couple of resistors as further described in the Procedure for **“Direct Mode”**.

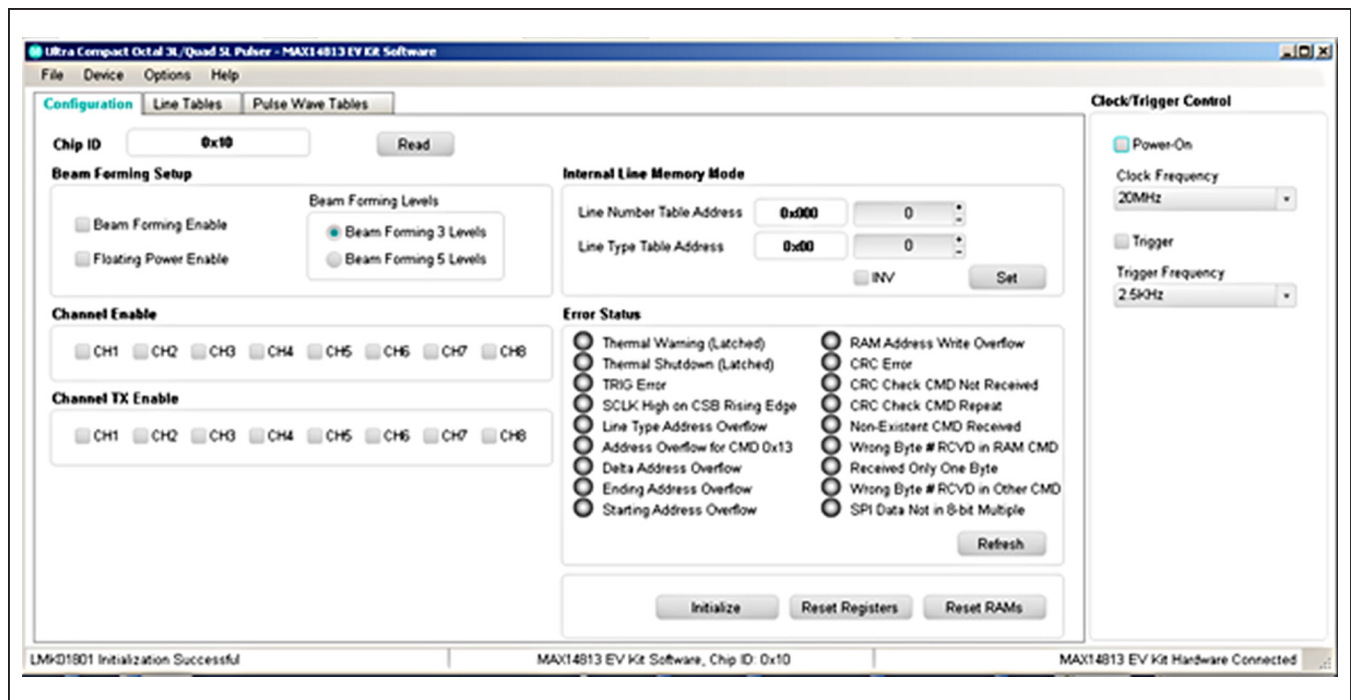

Figure 1. MAX14813 EV Kit Software Startup Window

Beam Forming Mode (MODE1 = MODE2 = 1)

- 1) Connect the PC to the EV kit using a Type B USB cable. Windows should automatically recognize the device and display a message in the lower-right status bar, indicating the EV kit driver is installed and the hardware is ready to use.
- 2) Verify that all jumpers are in their default positions for the EV kit ([Table 1](#)).
- 3) Connect the +5V DC power supply to the VCC_EXT test point.
- 4) Connect the -5V DC power supply to the VEE_EXT test point.
- 5) Connect the +3.3V DC power supply to the VIO_EXT test point.
- 6) Connect the +5V to +100V DC power supply to the VPPA test point.
- 7) Connect the -5V to -100V DC power supply to the VNNA test point.
- 8) If 5 levels configuration is used and therefore separate supplies are required for VPPA and VPPB, VNNA and VNNB, uninstall the shunts VPPA_VPPB and VNNA_VNNB and connect the optional +5V to +100V DC power supply to VPPB and the optional -5V to -100V power supply to VNNB.
- 9) Enable all of the power supplies in steps 3 to 8.
- 10) Through the provided GUI, program the device and the clock generator chip in order to obtain the desired outputs.
- 11) To observe the output signals from the IC, connect the oscilloscope to the HVOUT1–HVOUT8 scope-probe jacks.

Direct Mode (MODE1 = 1 and MODE2 = 0 or MODE1 = 0 and MODE2 = 1)

Direct mode is NOT controlled by the SPI port, but by input control pins. The INP4/TRIG pin has a double function: it works as a standard control pin INPx when in Direct mode, but it assumes the trigger function when in Beam Forming mode. Since the EV kit is prepared to work in Beam Forming mode, the INP4/TRIG pin is connected to the output of a clock generator through a 0Ω resistor (R0_TR). To use the EV kit in Direct mode, you have to

remove R0_TR and install R0_TR1 (0Ω) and open all the SW1 micro-switches.

Follow the steps below to verify board operation:

- 1) Connect the custom controller board or the pattern generator signals to the header H1 and H2 to drive the INN1-INN8, INP1-INP8 control signals (see [Table 4](#) and [Table 5](#). Refer to the MAX14813 IC data sheet for more information).
- 2) Verify that all jumpers are in the correct position as shown in [Table 1](#). In particular,
 - a. Change the jumper settings on MODE2 and MODE1 to configure MAX14813 into the Direct mode, either 3 levels configuration (MODE2 = 0, MODE1 = 1) or 5 levels configuration (MODE2 = 1, MODE1 = 0).
 - b. Install the jumper on CC0, CC1 to select the desired driving current.
- 3) Connect the +5V DC power supply to the VCC_EXT test point.
- 4) Connect the -5V DC power supply to the VEE_EXT test point.
- 5) Connect the +3.3V DC power supply to the VIO_EXT test point.
- 6) Connect the +5V to +100V DC power supply to the VPPA test point.
- 7) Connect the -5V to -100V DC power supply to the VNNA test point.
- 8) If 5 levels configuration is used and therefore separate supplies are required for VPPA and VPPB, VNNA and VNNB, uninstall the shunts VPPA_VPPB and VNNA_VNNB and connect the optional +5V to +100V DC power supply to VPPB and the optional -5V to -100V power supply to VNNB.
- 9) Make sure all the control signals INPx and INNx are stable low.
- 10) Enable all of the power supplies in steps 3 to 8.
- 11) Apply signals on INPx and INNx input control pins.
- 12) To observe the output signals from the IC, connect the oscilloscope to the HVOUT1–HVOUT8 scope-probe jacks.

Table 1. MAX14318 EV Kit Jumper Settings

JUMPER	SHUNT POSITION	DESCRIPTION
POWER SUPPLIES		
V_CLK	Open	Disables +3.3V supply to Clock Generator.
	Closed*	Enables +3.3V supply to Clock Generator.
VCC_REG	Open*	Disables on-board LDOs.
	Closed	Enables on-board LDOs.
VEE_SEL	1 - 2*	VEE for the MAX14813 is externally supplied.
	2 - 3	VEE for the MAX14813 is supplied by the on-board regulator (VCC_REG shunt needs to be installed).
VIO_SEL	1 - 2*	VIO for the MAX14813 is externally supplied.
	2 - 3	VIO for the MAX14813 is supplied by the on-board regulator (VCC_REG shunt needs to be installed).
VPPA_VPPB	Open	Use two high voltage positive supplies for VPPA and VPPB, respectively.
	Closed*	Use a single high voltage positive supply for both VPPA and VPPB.
VNNA_VNNB	Open	Use two high voltage negative supplies for VNNA and VNNB, respectively.
	Closed*	Use a single high voltage negative supply for both VNNA and VNNB.
OPERATING MODE		
MODE1	1 - 2*	Connect MODE1 to VIO.
	2 - 3	Connect MODE1 to GND.
MODE2	1 - 2*	Connect MODE2 to VIO.
	2 - 3	Connect MODE2 to GND.
SYNC (*Not Installed)	1 - 2	Enable the SYNC feature in Direct mode: the MAX14813 will sample each INP _x , INN _x on the rising edge of the clock signal. Remove this shunt if the MAX14813 is used in Beam Forming mode since in this case SYNC will be INT (INT will signal an SPI communication error).
	2 - 3	Disable the SYNC feature in Direct mode: the MAX14813 does not take care of the clock applied at its input. Remove this shunt if the MAX14813 is used in Beam Forming mode since in this case SYNC will be INT (INT will signal an SPI communication error).
INT	Open	Unconnected.
	Closed*	Connects a LED to INT signal so that any interrupt will be shown when in Beam Forming mode. Remove this shunt if the MAX14813 is used in Direct mode otherwise the LED will be always on when the shunt on SYNC/INT is connected to VIO.
CC0 (*not installed)	1 - 2	Connects the MAX14813 CC0 pin to VIO. See Table 3 for pulser current programmability truth table when in Direct mode. Remove this shunt if the pulser is used in Beam Forming mode since, in this case, CC0 will be the SPI SDIO.
	2 - 3	Connects the MAX14813 CC0 pin to GND. See Table 3 for pulser current programmability truth table when in Direct mode. Remove this shunt if the pulser is used in Beam Forming mode since in this case CC0 will be the SPI SDIO.

Table 1. MAX14318 EV Kit Jumper Settings (continued)

JUMPER	SHUNT POSITION	DESCRIPTION
CC1 (*not installed)	1 - 2	Connects the MAX14813 CC1 pin to VIO. See Table 3 for pulser current programmability truth table when in Direct mode. Remove this shunt if the pulser is used in Beam Forming mode since in this case CC1 will be the SPI SDO.
	2 - 3	Connects the MAX14813 CC1 pin to GND. See Table 3 for pulser current programmability truth table when in Direct mode. Remove this shunt if the pulser is used in Beam Forming mode since in this case CC0 will be the SPI SDO.
HV OUT		
OUT1_OUT5	Open*	HVOUT1 and HVOUT5 open.
	Closed	Shorts HVOUT1 to HVOUT5 for quad, five level mode.
OUT2_OUT6	Open*	HVOUT2 and HVOUT6 open.
	Closed	Shorts HVOUT1 to HVOUT5 for quad, five level mode.
OUT3_OUT7	Open*	HVOUT3 and HVOUT7 open.
	Closed	Shorts HVOUT1 to HVOUT5 for quad, five level mode.
OUT4_OUT8	Open*	HVOUT4 and HVOUT8 open.
	Closed	Shorts HVOUT1 to HVOUT5 for quad, five level mode.
LOAD1	Open	No load.
	Closed*	Connects a 220pF 1KΩ dummy load to HVOUT1.
LOAD2	Open	No load.
	Closed*	Connects a 220pF 1KΩ dummy load to HVOUT2.
LOAD3	Open	No load.
	Closed*	Connects a 220pF 1KΩ dummy load to HVOUT3.
LOAD4	Open	No load.
	Closed*	Connects a 220pF 1KΩ dummy load to HVOUT4.
LOAD5	Open	No load.
	Closed*	Connects a 220pF 1KΩ dummy load to HVOUT5.
LOAD6	Open	No load.
	Closed*	Connects a 220pF 1KΩ dummy load to HVOUT6.
LOAD7	Open	No load.
	Closed*	Connects a 220pF 1KΩ dummy load to HVOUT7.
LOAD8	Open	No load.
	Closed*	Connects a 220pF 1KΩ dummy load to HVOUT8.

Table 1. MAX14318 EV Kit Jumper Settings (continued)

JUMPER	SHUNT POSITION	DESCRIPTION
CONTROL INPUTS		
H1 (*not installed)	1,3,5,7,9, 11,13,15	GND
	2,4,6,8,10, 12,14,16	INN 5-8 and INP 5-8 Signals for Direct mode Operation To use the EV kit in Direct mode, you have to remove R0_TR and install R0_TR1 (0Ω) and open all the SW1 micro-switches.
H2 (*not installed)	1,3,5,7,9, 11,13,15	GND
	2,4,6,8,10, 12,14,16	INN 1-4 and INP 1-4 Signals for Direct mode operation. To use the EV Kit in Direct mode, you have to remove R0_TR and install R0_TR1 (0Ω) and open all the SW1 micro-switches.
J1	1	J1 is intended for a pattern generator source input. Never install a shunt on it. NOTE: In order to use external clock source on either J1 or J2, the 0Ω resistor R0_CK must be removed and the 0Ω resistor R0_CK1 must be installed (not provided). If the signal source needs to be terminated, a termination of 50Ω resistor can be mounted on R50_CK1 (not provided).
	2	GND
J2		Female SMA Connector for a pattern generator source input (same connection as J1-1 and scope probe connector CLK).
CLK (*not installed)		Low capacitance scope probe connector to monitor the signal on J1 and J2.
J4	1	J4 is intended for a pattern generator source input. Never install a shunt on it. NOTE: In order to use external trigger on either on J3 or J4, the 0Ω resistor R0_TR must be removed and the 0Ω resistor R0_TR1 must be installed. If the signal source needs to be terminated a 50Ω termination resistor can be mounted on R50_TR1 (not provided).
	2	GND
J3		Female SMA Connector for pattern generator source input (same connection as J4-1 and TRIG test point).
TRIG		Test point to monitor the signal on J4-1 and J3.
SW1 (DIP SWITCH)	1 - 8	Close all switches to enable on-board USB to SPI*. Open all switches to disable on-board USB to SPI and connect through connector SPI. Keep all the SW1 micro-switches open in Direct mode.
	2 - 7	
	3 - 6	
	4 - 5	

Table 1. MAX14318 EV Kit Jumper Settings (continued)

JUMPER	SHUNT POSITION	DESCRIPTION
SPI	1,3,4,6 - No Connection	10-pin header to use as test points for external SPI communication (selected through SW1). DO NOT USE JUMPERS TO SHORT PINS TOGETHER.
	2, 10 - GND	
	5 - SDO	
	7 - CLK	
	8 - SDIO	
	9 - CS	
J_USB		USB Type B connector.
RESET		USB to SPI Reset button.

*Default Position

Detailed Description of Software

A GUI is provided to support the evaluation of the MAX14813 in Beam Forming mode. The MAX14813 EV kit GUI only supports the **Internal Line Memory mode** (refer to MAX14813 IC data sheet for details). If the users wish to use the External Line Memory modes, they can hardwire the external SPI signals to SPI connector.

The main window of the EV kit software contains three tabs: Configuration, Line Tables, and Pulse Wave Tables and a panel accessible from any tabs to control the master clock and trigger **Clock/Trigger Control**. The Configuration tab provides control for the IC configuration, Beam Forming Setup, Channel Enable, and Error Status. The other two tabs are used for establishing desired data patterns.

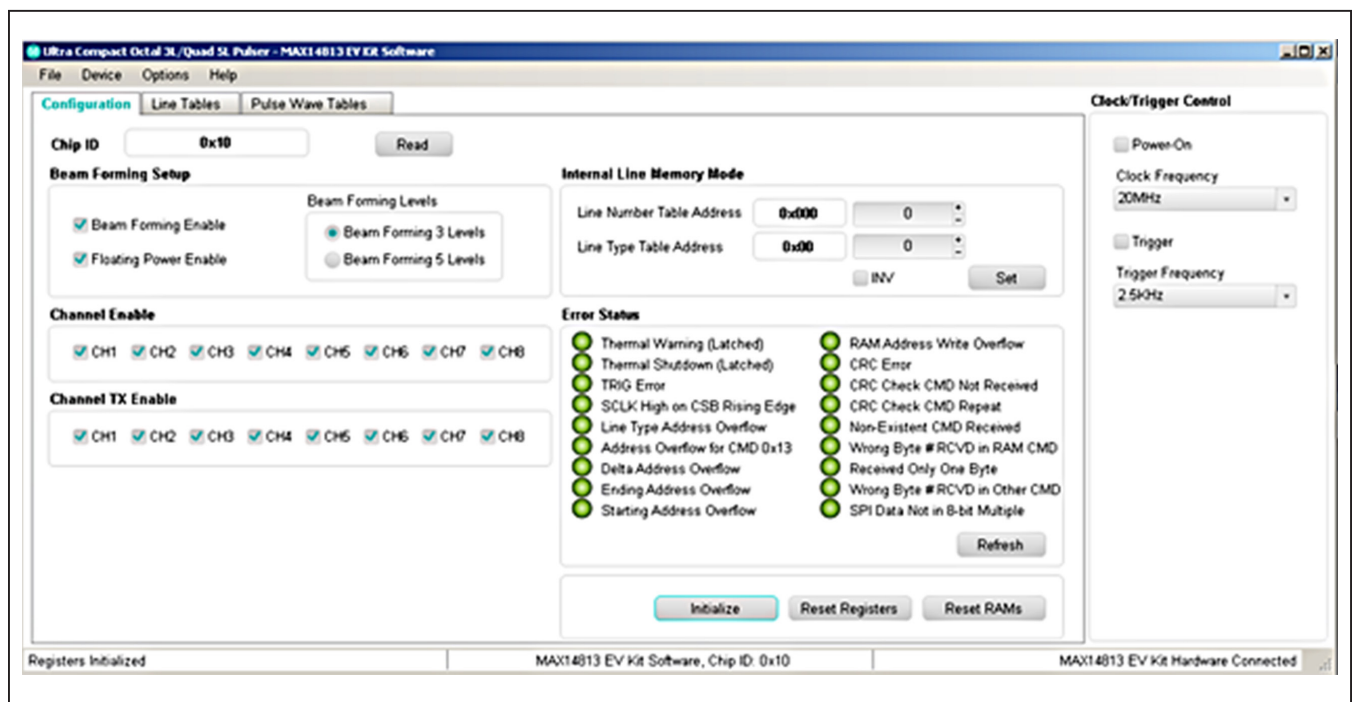

Figure 2. Main MAX14913 EV Kit Software Window

Configuration Tab

The **Configuration** tab provides an interface for selecting and configuring the IC from a functional perspective, see [Figure 3](#).

In order to prepare the MAX14813 to output a pattern, use this sequence:

- Press the button **Reset RAMs** to clear the Pulse Wave Table, Line Number Table, and Line Type Table.
- Press the button **Reset Registers** to clear the content of any registers and possible errors.
- Press the button **Initialize** to pre-fill the Configuration tab with default values.
- Since all the channels are enabled, verify if you want to use all of them by checking/unchecking the corresponding **Channel Enable** checkboxes and **Channel TX Enable** checkboxes.

- Configure the **Internal Line Memory mode** using the **Line Number Table Address**, the **Line Type Table Address** and the **INV** checkbox. Then press **Set** button. This corresponds to the “Set New Line 1” command in the MAX14813 IC data sheet register map. If you are not experienced with EV kit, do not change the default values.
 - The **Line Number Table** address is the address of the line containing the delay, the Pulse Wave Table address, etc.
 - The **Line Type Table** address is the address of the lines containing the global parameters like the cycles number, pulse duration, current of the pulser, etc.
 - The **INV** checkbox selects the phase of output pattern (in-phase or out-of-phase).
- Clicking **Refresh** will update the **Error Status** flags; red is an error and green is good. Please refer to the MAX14813 IC data sheet for a detailed explanation of each possible flags.

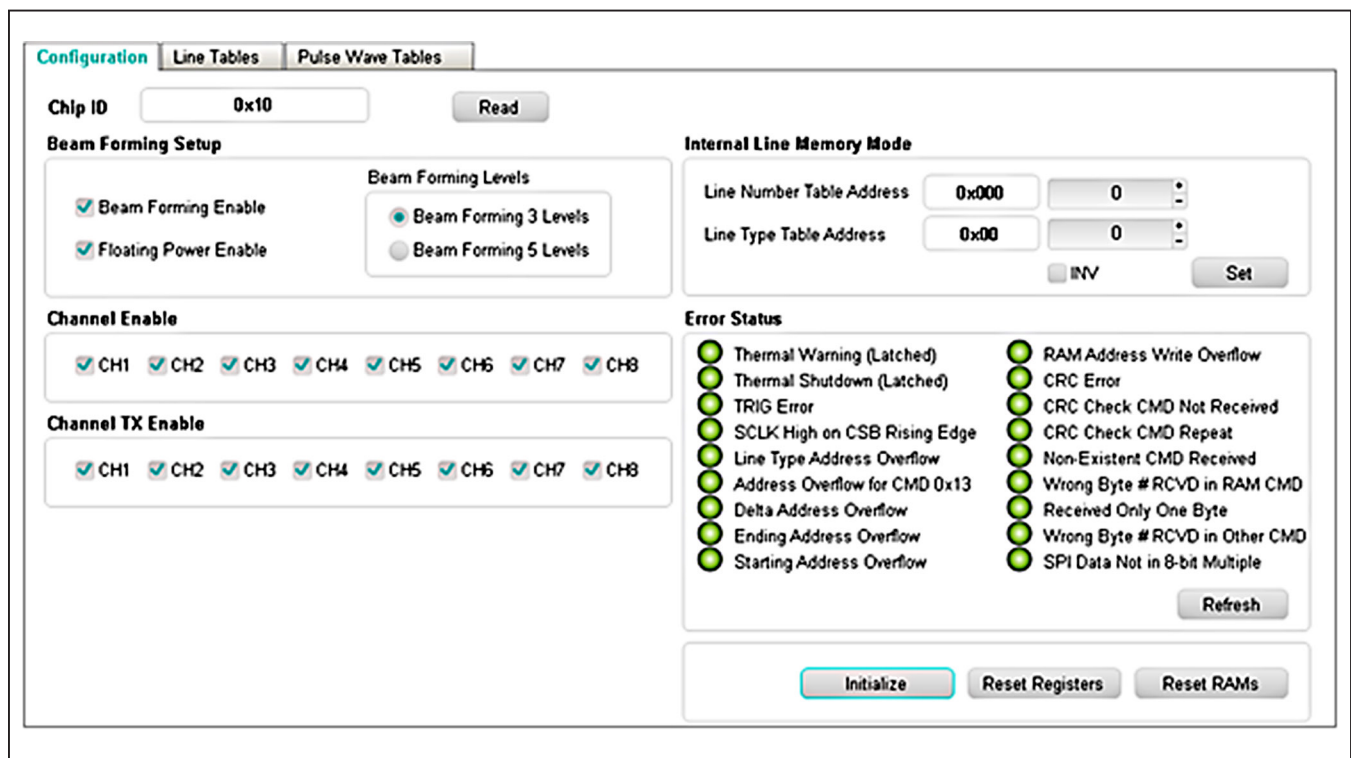

Figure 3. MAX14813 EV Kit Software - Configuration Tab

Line Tables Tab

The **Line Tables** tab allows the software to set the Line Type Tables and Line Number Tables, see [Figure 4](#). Line Type Tables will configure the cycles number, pulse duration, driving current of the pulser, etc., for all the channels. The Line Number Tables will configure the channel delay, the address of the pattern in the Pulse Wave Tables, etc., for each individual channel.

In order to prepare the MAX14813 to output a pattern, use this sequence:

- Go to the **Line Type Table**. It is a global register that affects all the channels, see [Figure 5](#). It contains 128 addresses, from 0 to 127.
- Use the **Address(Hex)** of the **Line Type Table** to select the address to be written. If you are not experienced with the EV kit, do not change the default values.
- To choose how many times to repeat the pattern, fill the **Cycles** number. Zero (0) means one cycle.

- To choose how many clock periods each pulse has to last, fill the **Pulse Width** number. Zero (0) means the pulse will last for a single period of clock. For example, to have a 5MHz pattern generated from a 20MHz master clock, if the **Pulse Wave Table** is **VPP**, **VNN**, and **EOP**, the **Pulse Width** has to be 1.
- Program the **Current** list to set the desired pulser current.
- Check the **CWD** checkbox to have a continuous pattern or uncheck it to have a finite pattern. **Please double check the VPP_ and VNN_ supply voltages when enabling the CWD function: VPP and VNN must be set at low voltages (less than +/-8V)! Using higher voltages in CWD mode will damage the device.**
- Press the **Write** button to update the pulser memory.

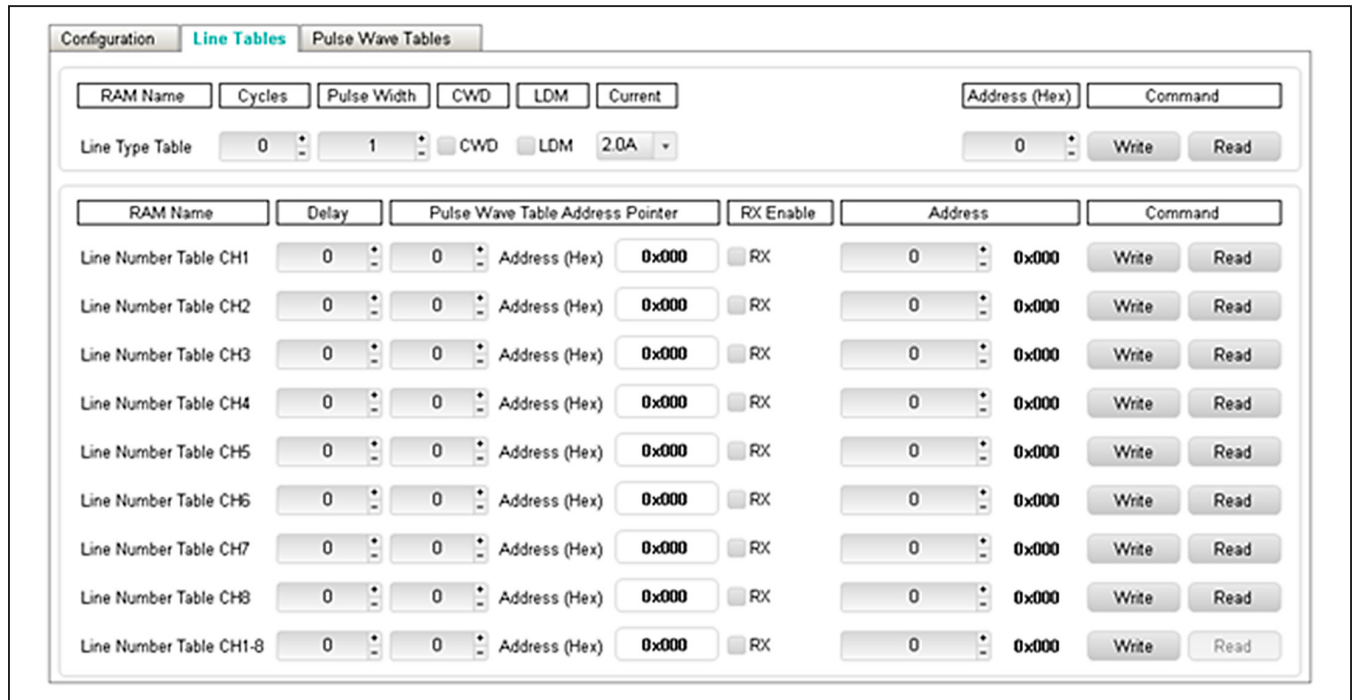

Figure 4. MAX14813 EV Kit Software - Line Tables Tab

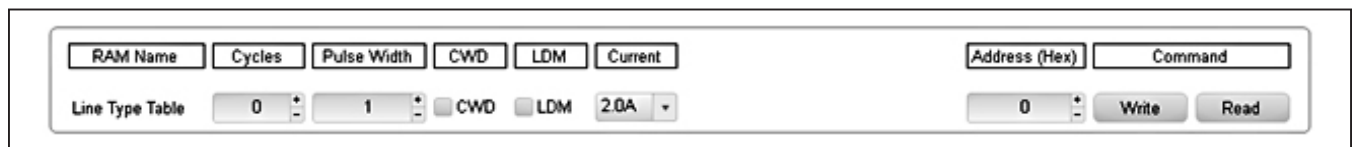

Figure 5. Line Type Table

In the **Line Tables** tab, you can also change the parameters in **Line Number Table** for each channel, see [Figure 6](#). Follow the example for channel 1 below to program the Line Number Table.

- Use the **Address** of the **Line Number Table** to select the address to be written. It contains 1536 addresses, from 0 to 1535. If you are not experienced with the EV kit, do not change the default values.
- To choose the delay of this channel in number of clock periods, fill the **Delay** number. Zero (0) means delay will be set by the fixed internal latency only (refer to the MAX14813 IC data sheet for details).

- To select the address of the pattern in the **Pulse Wave Table** to be used, fill the **Pulse Wave Table Address Pointer** number (see [Pulse Wave Tables Tab](#)).
- Check **RX** checkbox If the channel goes into receive mode after the pattern transmission.

You can also write the same value to a specific address for all channels simultaneously using the Line Number Table CH1-8, see [Figure 7](#).

Pulse Wave Tables Tab

The **Pulse Wave Tables** tab allows using the software to write a desired pattern to different Pulse Wave Table channels, see [Figure 8](#).

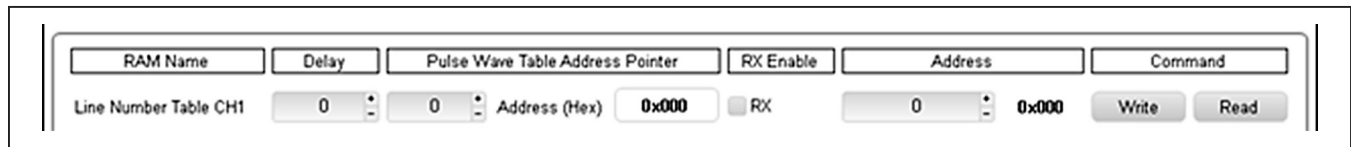

Figure 6. Line Number Table CH1



Figure 7. Line Number Table CH1-8

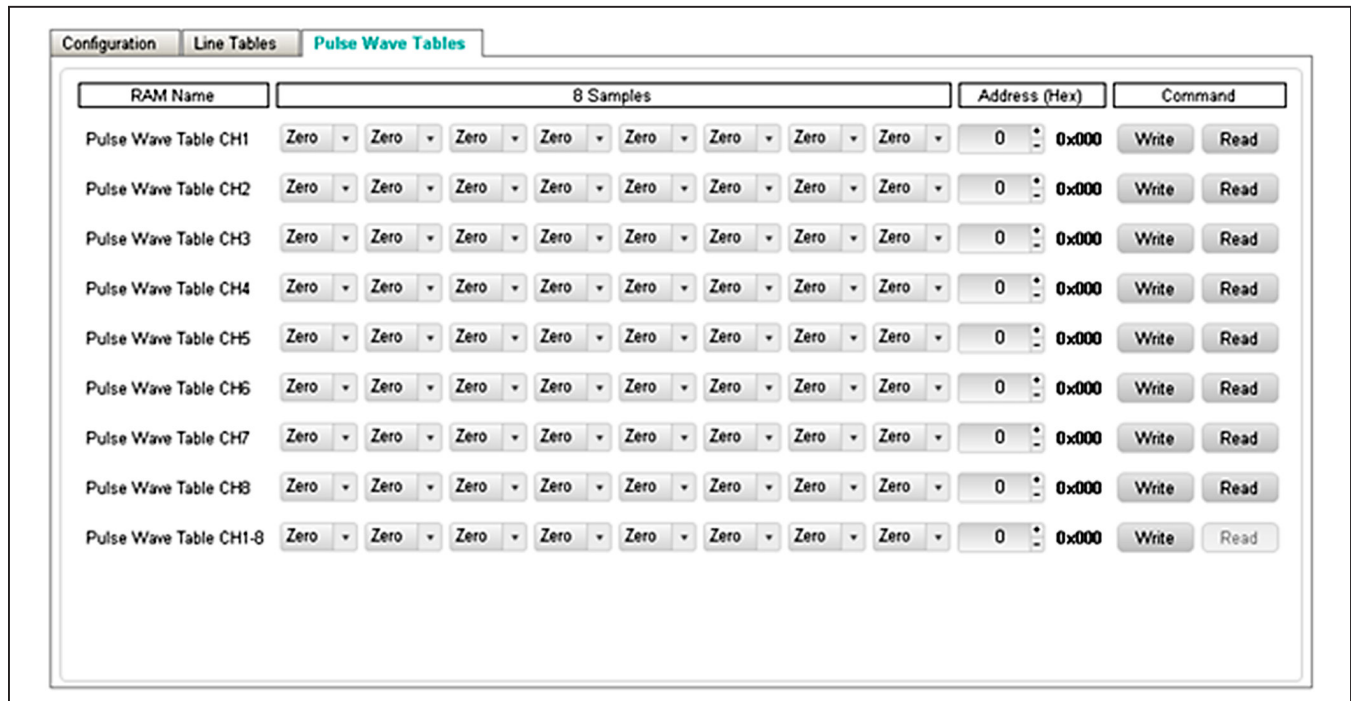

Figure 8. MAX14813 EV Kit Software - Pulse Wave Tables Tab

For example, in 3 Level Beam Forming mode, in order to create a VPP, VNN, ZERO and EOP pattern on Channel 1, use this sequence:

- Use the **Address(Hex)** of the **Pulse Wave Table** to select the address to be written. It contains 1024 addresses, from 0 to 1023. If you are not experienced with EV kit, do not change the default values.
- To select the patterns of the pulser, use the drop-down menus to fill the first four fields with **VPP**, **VNN**, **ZERO**, and **EOP** and press the **Write** button, see [Figure 9](#).
- It is mandatory to finish all sequences with an **EOP** (End of Pattern); otherwise, the pulser will not be able to know where to stop.
- If needed, create other patterns for the remaining channels using the same technique with the values from drop-down menus.
- The **Pulse Wave Table CH1-8** is useful to program all channels simultaneously with the same pattern, see [Figure 10](#). In this example, the pattern **VPP**, **VNN**, **ZERO**, and **EOP** will be written to the address 0 of all channels when pressing the **Write** button.

Clock/Trigger Control

The on-board high-speed clock and trigger generator can be programmed through EV kit software **Clock/Trigger Control** box. After MAX14813 is successfully configured, enable clock and trigger frequency to start Beam Forming mode operation.

To enable on-board clock and trigger frequency, use this sequence:

- Select the appropriate **Clock Frequency** from the drop-down menu.
- Select the appropriate **Trigger Frequency** that will determine the pulse repetition frequency (PRF) of the pattern.
- Check the **Power-On** checkbox.
- Check the **Trigger** checkbox.
- This will start the trigger and the pulser will fire the programmed pattern at the desired device frequency and pulse repetition frequency (PRF).
- To stop the pattern uncheck the **Trigger** checkbox.

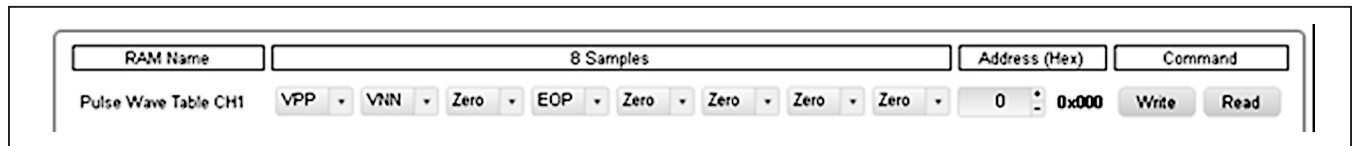

Figure 9. Pulse Wave Table CH1



Figure 10. Pulse Wave Table CH1-8

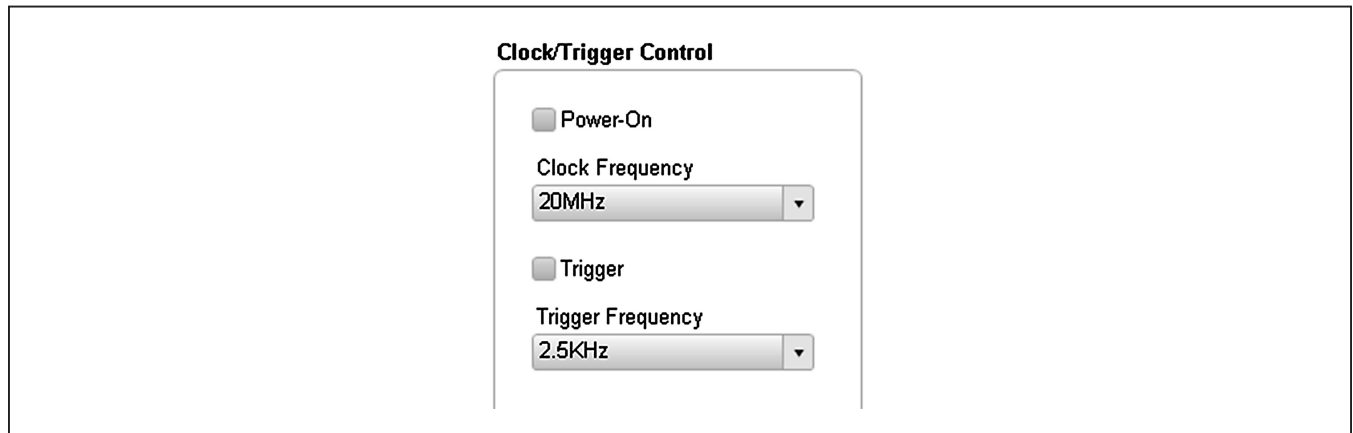

Figure 11. MAX14813 EV Kit Software—Clock/Trigger Control

Detailed Description of Hardware

The MAX14813 EV kit provides a proven layout for the IC and it provides an on-board USB to SPI interface, a high-speed clock and trigger in order to be able to evaluate the innovative Beam Forming feature with the simple use of a PC.

Power Supplies

The EV kit has the option to be powered entirely from external supplies or using on-board LDOs to generate low voltage supplies. At default, it is configured for external supplies, so VCC_EXT, VEE_EXT, and VIO_EXT are to be provided. To enable the LDOs, install the shunt on VCC_REG and move the shunts on jumpers VIO_SEL and VEE_SEL to position 2-3. In this case, only VCC_EXT is needed.

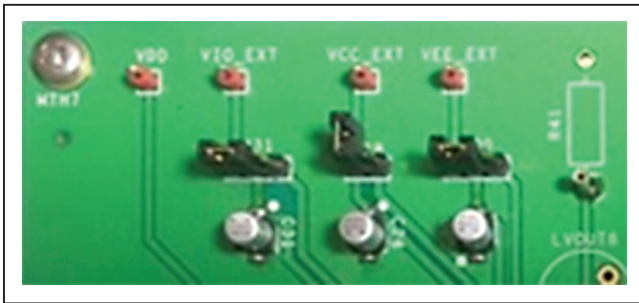

Default Configuration

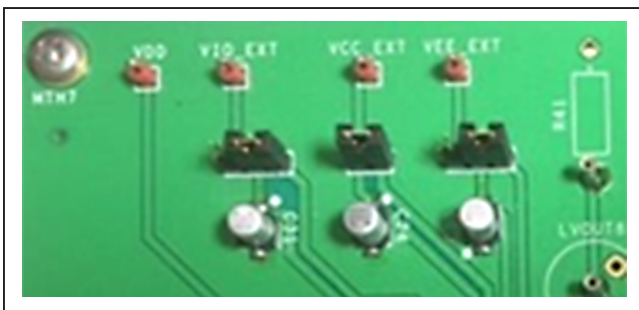

LDOs Enabled

If common voltage supplies are used for VPPA and VPPB, VNNA and VNNB, two fully independent high-voltage supplies (VNNA and VPPA) have to be provided from external power supplies by the use of the VNNA and VPPA test points, respectively. If separate supplies are used for VNNA and VNNB, VPPA and VPPB, four fully independent high-voltage supplies have to be provided from external power supplies by the use of the VNNA, VNNB, VPPA, and VPPB test points, respectively. In this case, remove the shunts VPPA_VPPB and VNNA_VNNB.

Programmable High-Speed Clock Generator and Trigger for Beam Forming Mode Evaluation

The EV kit has an on-board high-speed clock generator programmable through the GUI. This generator will also produce the trigger signal synchronous with the clock. The frequency of the trigger (PRF) will be programmed the same way as the clock by using the GUI. It is also possible to block the trigger in a low or high state. This will be useful when the pulser is configured in CW mode: a high state of the trigger will start the CW sequence; meanwhile a low state will stop it.

The FTDI chip receives the USB commands from the GUI and converts to μ -wire/SPI signals for on-board clock generator configuration.

A single-ended clock can also be provided to the MAX14813 externally through the female SMA connector J2 or the header J1. It can be probed at the CLK socket (provided, not installed). To use these connectors, disconnect the on-board clock signal by removing the 0 Ω resistor R0_CK and installing the 0 Ω resistor R0_CK1.

In a similar way, a single-ended trigger can be provided to the MAX14813 externally through the female SMA connector J3 or the header J4. It can be probed at the TRIG test point. To use these connectors, disconnect the on-board trigger by removing the 0 Ω resistor R0_TR and installing the 0 Ω resistor R0_TR1.

Operating Modes

The operating modes are set by the MODE1 and MODE2 inputs. These inputs can be manually configured by the shunt positions, as described in [Table 2](#). In Direct mode, when MODE1 = 1 and MODE2 = 0, the MAX14813 can generate a 3-level pulsing scheme. If MODE1 = 0 and MODE2 = 1 the MAX14813 can generate a 5-level dual mode pulsing scheme when HVOUT1/HVOUT5, HVOUT2/HVOUT6, HVOUT3/HVOUT7, and HVOUT4/HVOUT8 are shorted by placing a shunt on OUT1_OUT5, OUT2_OUT6, OUT3_OUT7, OUT4_OUT8 headers.

To use the innovative Beam Forming feature, MODE1 and MODE2 have to be both high. All the features of the pulser can be programmed via SPI port. Please read the MAX14813 IC data sheet to learn how to use this operating mode.

Depending on the logic combination of the INN_x, INP_x input pin, the pulser operates either from VPPA, VNNA or from VPPB, VNNB with up to 2A driving current. The pulser output current can be set based on the shunt positions of CC0 and CC1, as shown in [Table 3](#).

Table 2. Operating Modes

MODE1	MODE2	OPERATING MODE
0	0	Shut Down
1	0	Octal Three Levels
0	1	Quad Five Levels
1	1	Beam Forming

Table 3. Pulser Output Current (Typical)

CC0	CC1	PULSER OUTPUT CURRENT (TYP) (A)
0	0	2
1	0	1.2
0	1	0.7
1	1	0.35

[Table 4](#) describes the combination between the logic signals INN_x and INP_x and voltage outputs HVOUT and LVOUT in Direct mode octal 3 levels. [Table 5](#) describes the combination between the logic signals INN_x, INP_x, INN_y, and INP_y and voltage outputs HVOUT and LVOUT in Direct mode quad 5 levels.

High-Voltage Outputs

The high-voltage outputs can be observed on the oscilloscope using HVOUT1–HVOUT8 scope-probe jacks. The high-voltage scope-probe jacks are not installed but the pads are present on the PCB and components are included.

Low-Voltage Outputs

The low-voltage outputs can be observed on the oscilloscope using LVOUT1–LVOUT8 or scope-probe jacks. The low-voltage output scope-probe jacks are not installed but the pads are present on the PCB and components are included.

Table 4. MODE1 = 1, MODE2 = 0 Octal 3 Levels

INN _x	INP _x	HVOUT _x	LVOUT _x
0	0	Clamp ON Damp OFF	TR Switch OFF LVOUT = Hi-Z
0	1	VPP Damp OFF	TR Switch OFF LVOUT = Hi-Z
1	0	VNN Damp OFF	TR Switch OFF LVOUT = Hi-Z
1	1	Clamp ON Damp ON	TR Switch ON

Table 5. MODE1 = 0, MODE2 = 1 Quad 5 Levels Dual Mode

INN _x X = 1,2,3,4	INP _x X = 1,2,3,4	INN _y "SEL" Y = 5,6,7,8	INP _y "RTZ" Y = 5,6,7,8	HVOUT _x = HVOUT _y	LVOUT _x x = 1,2,3,4	LVOUT _y x = 5,6,7,8
0	0	X	0	Hi-Z Damp OFF	TR Switch OFF LVOUT = Hi-Z	TR Switch OFF LVOUT = Hi-Z
0	0	X	1	Clamp ON Damp OFF	TR Switch OFF LVOUT = Hi-Z	TR Switch OFF LVOUT = Hi-Z
0	1	0	X	VPPA Damp OFF	TR Switch OFF LVOUT = Hi-Z	TR Switch OFF LVOUT = Hi-Z
1	0	0	X	VNNA Damp OFF	TR Switch OFF LVOUT = Hi-Z	TR Switch OFF LVOUT = Hi-Z
0	1	1	X	VPPB Damp OFF	TR Switch OFF LVOUT = Hi-Z	TR Switch OFF LVOUT = Hi-Z
1	0	1	X	VNNB Damp OFF	TR Switch OFF LVOUT = Hi-Z	TR Switch OFF LVOUT = Hi-Z
1	1	1	X	Clamp ON Damp ON	TR Switch ON	TR Switch OFF LVOUT = Hi-Z

Ordering Information

PART	TYPE
MAX14813EVKIT#	EV KIT

#Denotes RoHS compliant.

The MAX14813EVKIT# includes the MAX14813EWX+ in a 156-Bump WLP.

MAX14813 Evaluation Kit

Evaluates: MAX14813

MAX14813 EV Bill of Materials

ITEM	REF_DES	DNI/DNP	QTY	MFG PART #	MANUFACTURER	VALUE	DESCRIPTION
1	C1-C5, C7, C9, C10, C13, C15, C18-C20, C34, C37, C47, C64, C65, C67	-	19	GRM188R61A105K461, C1608XSR1A105K	MURATA/TKD	1µF	CAPACITOR: SMT (0603); CERAMIC CHIP; 1µF; 10V; TOL = 10%; MODEL+: TG = -55°C TO +85°C; TC = X5R;
2	C6, C8, C11, C12, C16, C27-C29	-	8	CGA5L3X72E224K160	TDK	0.22µF	CAPACITOR: SMT (1206); CERAMIC CHIP; 0.22µF; 250V; TOL = 10%; TG = -55°C TO +125°C; TC = X7T AUTO
3	C24, C30, C31, C61	-	4	RFS1A100M0N1GB	NICHICON	10µF	CAPACITOR: SMT (CASE_B); ALUMINUM-ELECTROLYTIC; 10µF; 10V; TOL = 20%; MODEL+: TG = -55°C TO +105°C
4	C32	-	1	TPSA106M010R0900	AVX	10µF	CAPACITOR: SMT (3216); TANTALUM CHIP; 10µF; 10V; TOL = 20%; MODEL +TPS SERIES; TG = -55°C TO +125°C
5	C33	-	1	C0603C0G500-820JNE; GRM1885C1H820JA01	VENKEL LTD./MURATA	82PF	CAPACITOR: SMT (0603); CERAMIC CHIP; 82PF; 50V; TOL = 5%; MODEL+: TG = -55°C TO +125°C; TC = C0G
6	C35	-	1	B45197A2478K409	KEMET	47µF	CAPACITOR: SMT (7343); TANTALUM CHIP; 47µF; 10V; TOL = 10%; MODEL = B45197A SERIES; TG = -55°C TO +125°C
7	C36, C38-C46, C49-C58, C72, C73	-	22	C0603C104K9RAC; GRM188R70J104K401	KEMET; MURATA	0.1µF	CAPACITOR: SMT (0603); CERAMIC CHIP; 0.1µF; 6.3V; TOL = 10%; MODEL+: TG = -55°C TO +125°C; TC = X7R;
8	C58, C60	-	2	GRM39C0G220J50V; GRM1885C1H220J; C1608C0G1H220J090AA	MURATA/TKD	22PF	CAPACITOR: SMT (0603); CERAMIC CHIP; 22PF; 50V; TOL = 5%; MODEL+: TG = -55°C TO +125°C; TC = C0G
9	C62	-	1	C0603C475K9PAC; GRM188R6J475K19; C1608XSR6J475K080AB; ECJ-1V80J475K	KEMET/MURATA/TKD/PANASONIC	4.7µF	CAPACITOR: SMT (0603); CERAMIC CHIP; 4.7µF; 6.3V; TOL = 10%; MODEL+: TG = -55°C TO +125°C; TC = X5R;
10	C63	-	1	593D107X0010D	VISHAY SPRAGUE	100µF	CAPACITOR: SMT (7343); TANTALUM CHIP; 100µF; 10V; TOL = 20%; MODEL = 593D SERIES; TG = -55°C TO +125°C
11	C68	-	1	TAJR105K010RNU	AVX	1µF	CAPACITOR: SMT (2012); TANTALUM CHIP; 1µF; 10V; TOL = 10%
12	C68-C71	-	4	EEV-EB2C100Q	PANASONIC	10µF	CAPACITOR: SMT (CASE_G); ALUMINUM-ELECTROLYTIC; 10µF; 160V; TOL = 20%; MODEL=EEV SERIES; TG=-40°C TO +105°C
13	CH1-CH8	-	8	C0603C221K1GAC	KEMET	220PF	CAPACITOR: SMT (0603); CERAMIC CHIP; 220PF; 100V; TOL = 10%; MODEL = C0G; TG = -55°C TO +125°C; TC = +TBD
14	D1	-	1	SS12	FAIRCHILD SEMICONDUCTOR	SS12	DIODE: SCH: SMT (DO-214AC); V = 20V; I = 1.0A
15	DINT, DTHP	-	2	LX3044GD	Lumex Opto/Components Inc	LX3044GD	GREEN LIGHT EMITTING DIODE
16	J1, J4, INT_LOAD1+LOAD8, V_CLK, VCC_REG, OUT1_OUT5, OUT2_OUT6, OUT3_OUT7, OUT4_OUT8, VINA_VINNB, VPPA_VPPB	-	19	PCC02SAAN	SULLINS	PCC02SAAN	CONNECTOR: MALE; THROUGH HOLE; BREAKAWAY; STRAIGHT THROUGH; 2PINS; -65°C TO +125°C
17	J2, J3	-	2	CONSM4002	LINX TECHNOLOGIES	CONSM4002	CONNECTOR: FEMALE; THROUGH HOLE; SMA PCB MOUNT; RIGHT ANGLE; 5PINS
18	J5, J6, J11-J16, J19-J22, J32-J35, VBUS	-	17	PBC01SAAN	SULLINS ELECTRONICS CORP	PBC01SAAN	CONNECTOR: MALE; THROUGH HOLE; BREAKAWAY; STRAIGHT; 1PIN
19	J7-J10, J57-J60	-	8	5001	KEYSTONE	N/A	TEST POINT; PIN DIA = 0.1IN; TOTAL LENGTH = 0.3IN; BOARD HOLE = 0.04IN; BLACK; PHOSPHOR BRONZE WIRE SILVER PLATE FINISH
20	J_USB	-	1	67068-9000	MOLEX	67068-9000	CONNECTOR: FEMALE; THROUGH HOLE; USB B-TYPE CONNECTOR WHITE; RIGHT ANGLE; 4PINS
21	L1	-	1	BLM18SG331TNT	MURATA	330	INDUCTOR: SMT (0603); FERRITE-BEAD; 330; TOL = ±25%; 1.5A
22	L2	-	1	CR54NP-100MC	SUMIDA	10µH	INDUCTOR: SMT; MAGNETICALLY SHIELDED FERRITE BOBBIN CORE; 10µH; TOL = ±20%; 1.4A
23	MODE1, MODE2, VEE_SEL, VIO_SEL	-	4	PCC03SAAN	SULLINS	PCC03SAAN	CONNECTOR: MALE; THROUGH HOLE; BREAKAWAY; STRAIGHT THROUGH; 3PINS; -65°C TO +125°C
24	RO_CK, RO_TR	-	2	CRCW06030000ZS; MCR03E2PJ000; ERJ-3GEY0R00	VISHAY DALE/ROHM/PANASONIC	0	RESISTOR: 0603; 0Ω; 0%; JUMPER; 0.10W; THICK FILM
25	R7, R9, R12, R15, R16, R18, RS2	-	7	CRCW0603100R0FK; ERJ-3EK1F1000	VISHAY DALE/PANASONIC	100	RESISTOR: 0603; 100Ω; 1%; 100PPM; 0.10W; THICK FILM
26	R13, R51	-	2	CRCW0603560R0FK	VISHAY DALE	560	RESISTOR: 0603; 560Ω; 1%; 100PPM; 0.10W; THICK FILM
27	R14, R19, RS3	-	3	CR0603-FX-1001ELF	BOURNS	1K	RESISTOR: 0603; 1KΩ; 1%; 100PPM; 0.10W; THICK FILM
28	R34, R35, R38, R39, R42-R45, R66-R73	-	16	MCR03E2PFX2002; ERJ-3EK1F2002	ROHM; PANASONIC	20K	RESISTOR: 0603; 20KΩ; 1%; 100PPM; 0.10W; THICK FILM
29	RS5	-	1	ERA-3YEB202V	PANASONIC	2K	RESISTOR: 0603; 2KΩ; 0.1%; 25PPM; 0.10W; THICK FILM
30	RS6	-	1	ERA-3YEB113V	PANASONIC	11K	RESISTOR: 0603; 11KΩ; 0.1%; 25PPM; 0.10W; METAL FILM
31	RS7-R59, R74, R77	-	5	CRCW060310K0FK; 9C06031A102FK; ERJ-3EK1F102	VISHAY DALE/YAGEO/PHICOMP/PANASONIC	10K	RESISTOR: 0603; 10KΩ; 1%; 100PPM; 0.10W; THICK FILM
32	R75	-	1	ERJ-3EK1F130V	PANASONIC	130K	RESISTOR: 0603; 130KΩ; 1%; 100PPM; 0.10W; THICK FILM
33	R76	-	1	CRCW0603300K0FK	VISHAY DALE	300K	RESISTOR: 0603; 300KΩ; 1%; 100PPM; 0.1W; THICK FILM
34	R78	-	1	CRCW0603470K0FK	VISHAY DALE	47K	RESISTOR: 0603; 47KΩ; 1%; 100PPM; 0.10W; THICK FILM
35	R79	-	1	ERJ-3EK1F1693V	PANASONIC	169K	RESISTOR: 0603; 169KΩ; 1%; 100PPM; 0.10W; THICK FILM
36	R80	-	1	ERA-3AEB104; AT0603BRD07100KL	PANASONIC	100K	RESISTOR: 0603; 100KΩ; 0.1%; 25PPM; 0.1W; THIN FILM
37	RESET	-	1	FSM4JSMA	TE CONNECTIVITY	FSM4JSMA	SWITCH; SPST; SMT; 12V; 0.05A; FSM4JSMA SERIES; TACTILE SWITCH; RCOIL = 0.1Ω; RINSULATION = 1GΩ
38	RHV1-RHV8	-	8	ERJ-1TYJ102J	PANASONIC	1K	RESISTOR: 2512; 1KΩ; 5%; 100PPM; 1.0W; THICK FILM
39	SP1	-	1	961210-6404-AR	3M	961210-6404-AR	CONNECTOR: THROUGH HOLE; PIN STRIP HEADER; STRAIGHT; 10PINS
40	SU1-SU27	-	27	STC02SYAN	SULLINS ELECTRONICS CORP.	STC02SYAN	TEST POINT; JUMPER; STR; TOTAL LENGTH = 0.25IN; BLACK; INSULATION = PBT CONTACT = PHOSPHOR BRONZE; COPPER PLATED TIN OVERALL
41	SW1	-	1	DBS 3104	KNITTER-SWITCH	DBS 3104	SWITCH; SPST; THROUGH HOLE; 24V; 0.025A; DBS 3100 SERIES; DUAL-IN-LINE SWITCH; RCOIL=0.05 OHM; RINSULATION=100MG; KNITTER-SWITCH
42	TRIG, VINA, VINNB, VPPA, VPPB, VCC_EXT, VEE_EXT, VIO_EXT	-	8	5000	KEYSTONE	N/A	TEST POINT; PIN DIA = 0.1IN; TOTAL LENGTH = 0.3IN; BOARD HOLE = 0.04IN; RED; PHOSPHOR BRONZE WIRE SILVER PLATE FINISH
43	U1	-	1	MAX14813EXP+	MAXIM	MAX14813EXP+	EVKIT PART -IC; PACKAGE OUTLINE 156 BUMPS; WLP PKG 0.5MM PITCH; W1566A6+1; 21-100007
44	U3	-	1	MAX1806UA33+	MAXIM	MAX1806UA33+	IC; VREG; LOW-VOLTAGE LINEAR REGULATOR; UMAX8-EP
45	U4	-	1	FT232RL	FUTURE TECHNOLOGY DEVICES INTL. LTD.	FT232RL	IC; MMRY; DUAL HIGH SPEED USB TO MULTIPURPOSE UART/FFO; LQFP64
46	U5	-	1	MAX755CSA+	MAXIM	MAX755CSA+	IC; VREG; -5VADJUSTABLE; NEGATIVE-OUTPUT; INVERTING; CURRENT-LIMODE PWM REGULATOR; NSOIC8 150ML
47	U6	-	1	LMK01801B18ISE/NORB	?	LMK01801B18ISE/NORB	IC; CLK; LMK01801 DUAL CLOCK DIVIDER BUFFER; WQFN48-EP 7X7
48	U7	-	1	MAX1735ELK50+	MAXIM	MAX1735ELK50+	IC; VREG; NEGATIVE-OUTPUT LOW-DROPOUT LINEAR REGULATOR; SOT23-5
49	U8	-	1	MAX882EXK+	MAXIM INTEGRATED	MAX882EXK+	IC; VREG; HIGH PSRR; LOW DROP-OUT LINEAR REGULATOR; SC70-5
50	U9	-	1	93LC46B-I/ST	MICROCHIP	93LC46B-I/ST	IC; EPROM; 16 BIT; 1K 2.5V MICROWIRE SERIAL EEPROM; TSSOP8 3X4.4
51	VDD	-	1	5116	KEYSTONE	N/A	TEST POINT; PIN DIA=0.1IN; TOTAL LENGTH=0.3IN; BOARD HOLE = 0.04IN; GREEN; PHOSPHOR BRONZE WIRE SILVER PLATE FINISH
52	Y1	-	1	ABLJ0-160.000MHZ	ABRACON	ABLJ0-160.000MHZ	OSCILLATOR: SMT 14 3 X 8 X 7.5mm; 15PF; 160MHZ; ±25PPM
53	Y2	-	1	ABL52-12.000MHZ-D4Y-T	ABRACON	12MHZ	CRYSTAL: SMT; 12PF; 12MHZ; ±30PPM
54	CLK, HVOUT1+HVOUT8	DNI	9	131-5031-00	TEKTRONIX	131-5031-00	CONNECTOR: WIREMOUNT; 3 GHZ 20X LOW CAPACITANCE PROBE; STRAIGHT; 5PINS
55	MTH1-MTH8	DNI	8	EVKIT_STANDOFF_M2_5_20MM	?	EVKIT_STANDOFF_M2_5_20MM	KIT; ASSY-STANDOFF20MM; 1PC; STANDOFF; FEM/HEX M2.5(20MM)/ALUMINUM; 1PC; SCREW/SLOT/PAN M2.5(6MM)/STEEL; ZINC PLATE
56	CC0, CC1, SYNC	DNP	0	PCC03SAAN	SULLINS	PCC03SAAN	CONNECTOR: MALE; THROUGH HOLE; BREAKAWAY; STRAIGHT THROUGH; 3PINS; -65°C TO +125°C
57	H1, H2	DNP	0	PEC08DAAN	SULLINS ELECTRONICS CORP.	PEC08DAAN	CONNECTOR: MALE; THROUGH HOLE; BREAKAWAY; STRAIGHT; 16PINS; -65°C TO +125°C
58	LVOU1-LVOU8	DNP	0	131-5031-00	TEKTRONIX	131-5031-00	CONNECTOR: WIREMOUNT; 3 GHZ 20X LOW CAPACITANCE PROBE; STRAIGHT; 5PINS
59	RL1-CK1, RL1-TR1, RL1-CV1, RL1-DEA, RL1-TB1	DNP	0	N/A	TBD	OPEN	RESISTOR: 0603; OPEN; FORMFACTOR
60	RLV1-RLV8	DNP	0	N/A	N/A	TBD	PACKAGE OUTLINE CFM1 RESISTOR THROUGH HOLE WITH HOLE DIAMETER RECEPTACLE 9555
61	PCB	-	1	MAX14813	MAXIM	PCB	PCB Board MAX14813 EVALUATION KIT
TOTAL			246				

MAX14813 EV Schematics (continued)

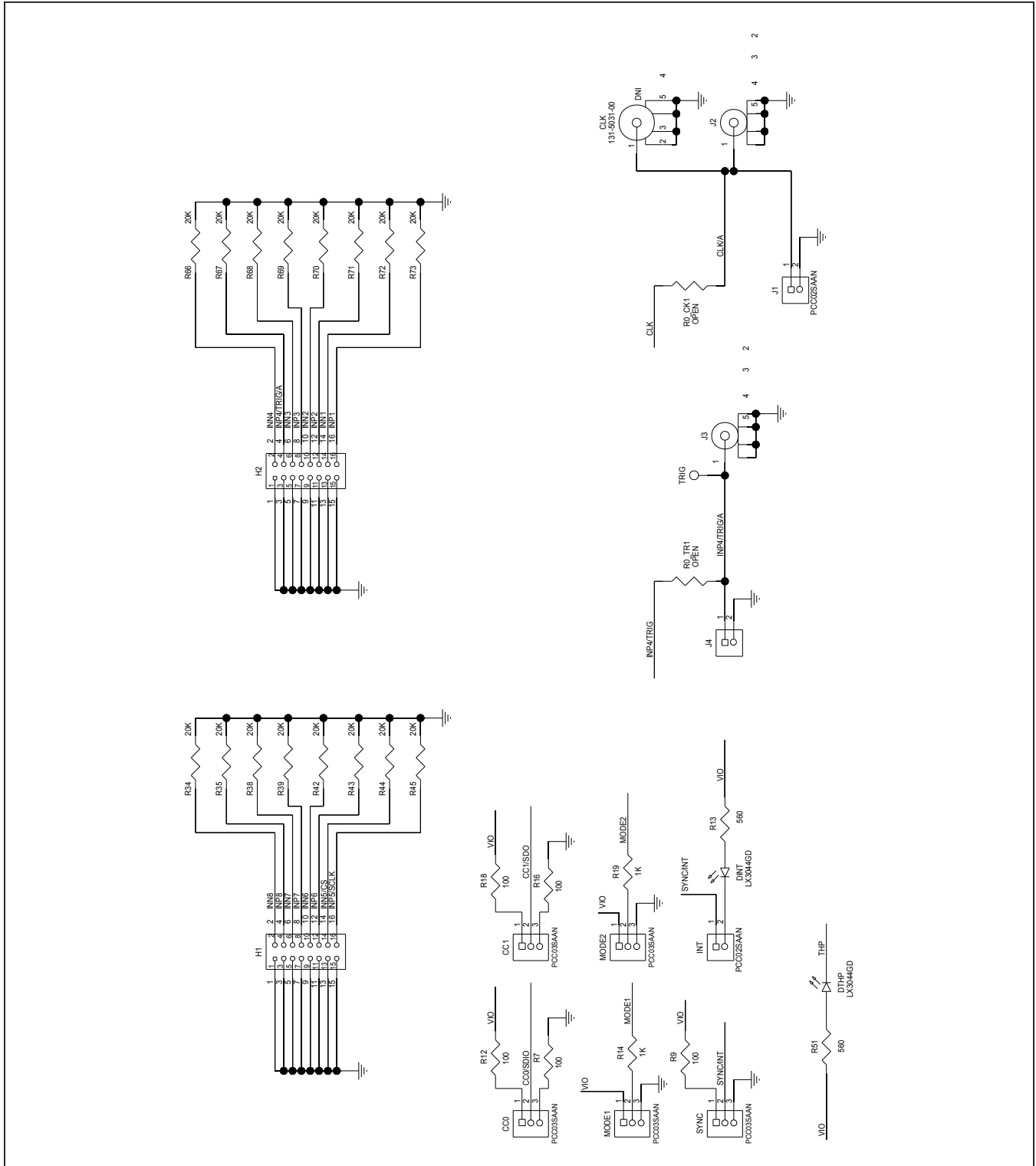

MAX14813 EV Schematics (continued)

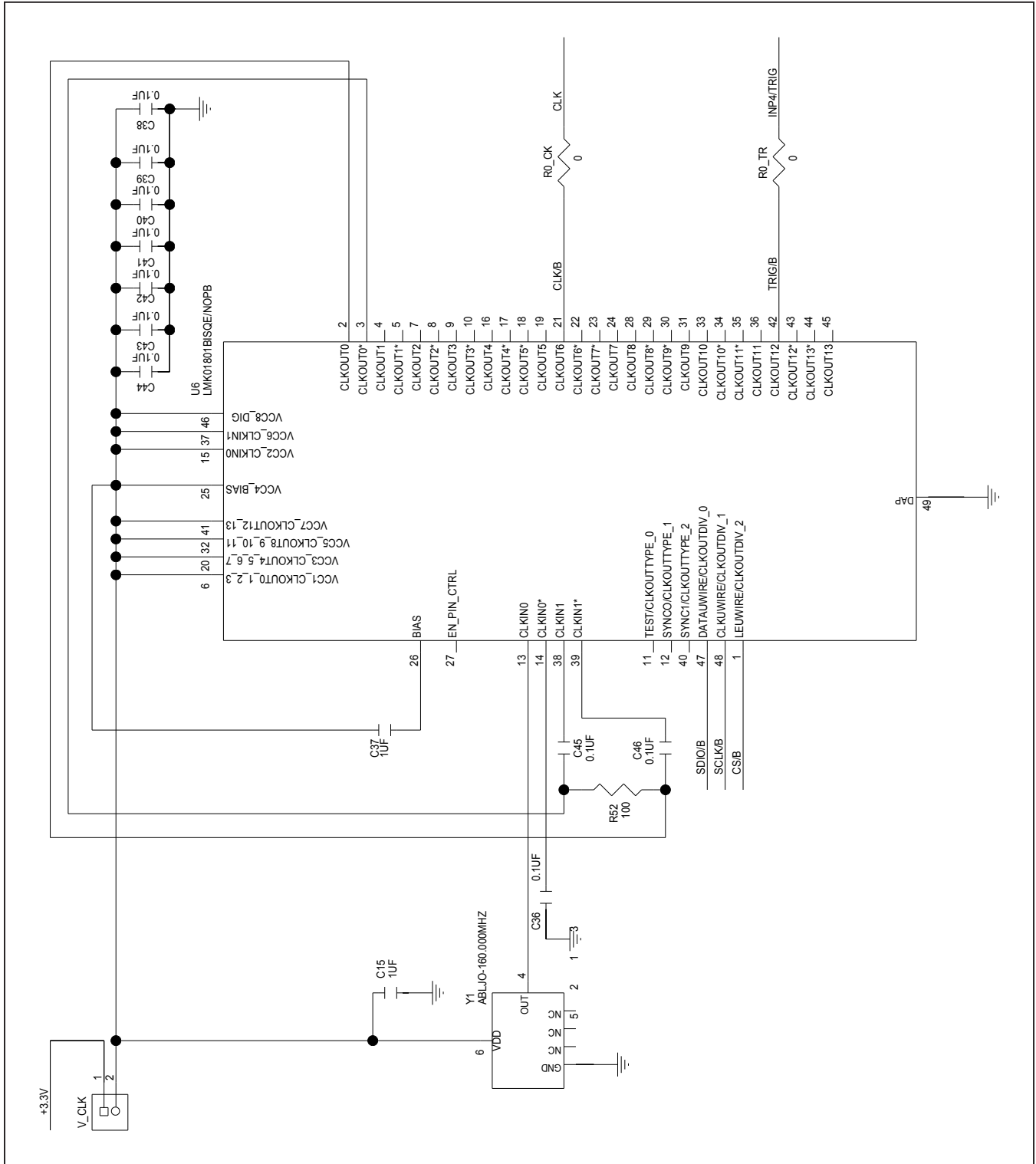

MAX14813 EV PCB Layout (continued)

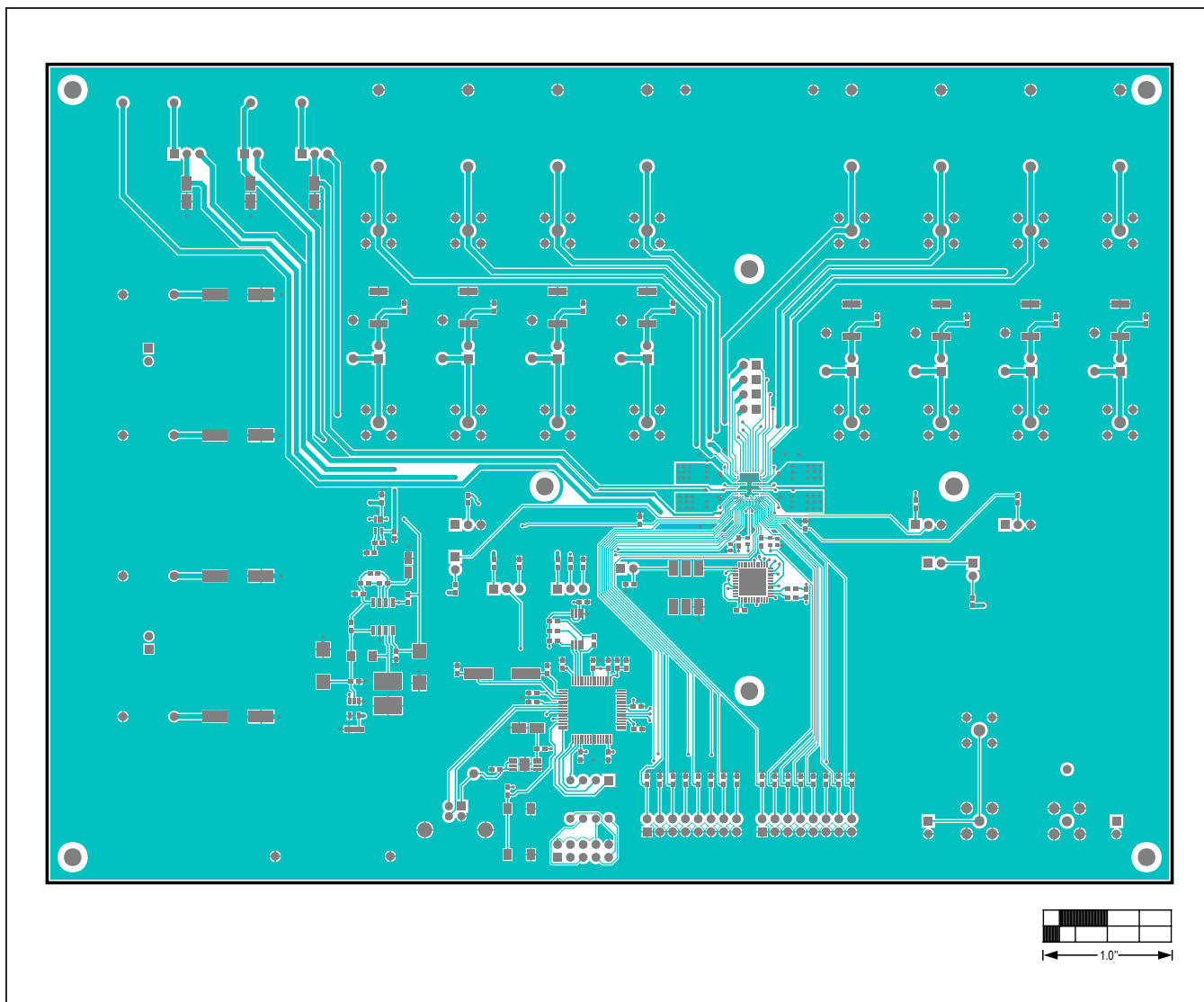

MAX14813 EV PCB Layout (continued)

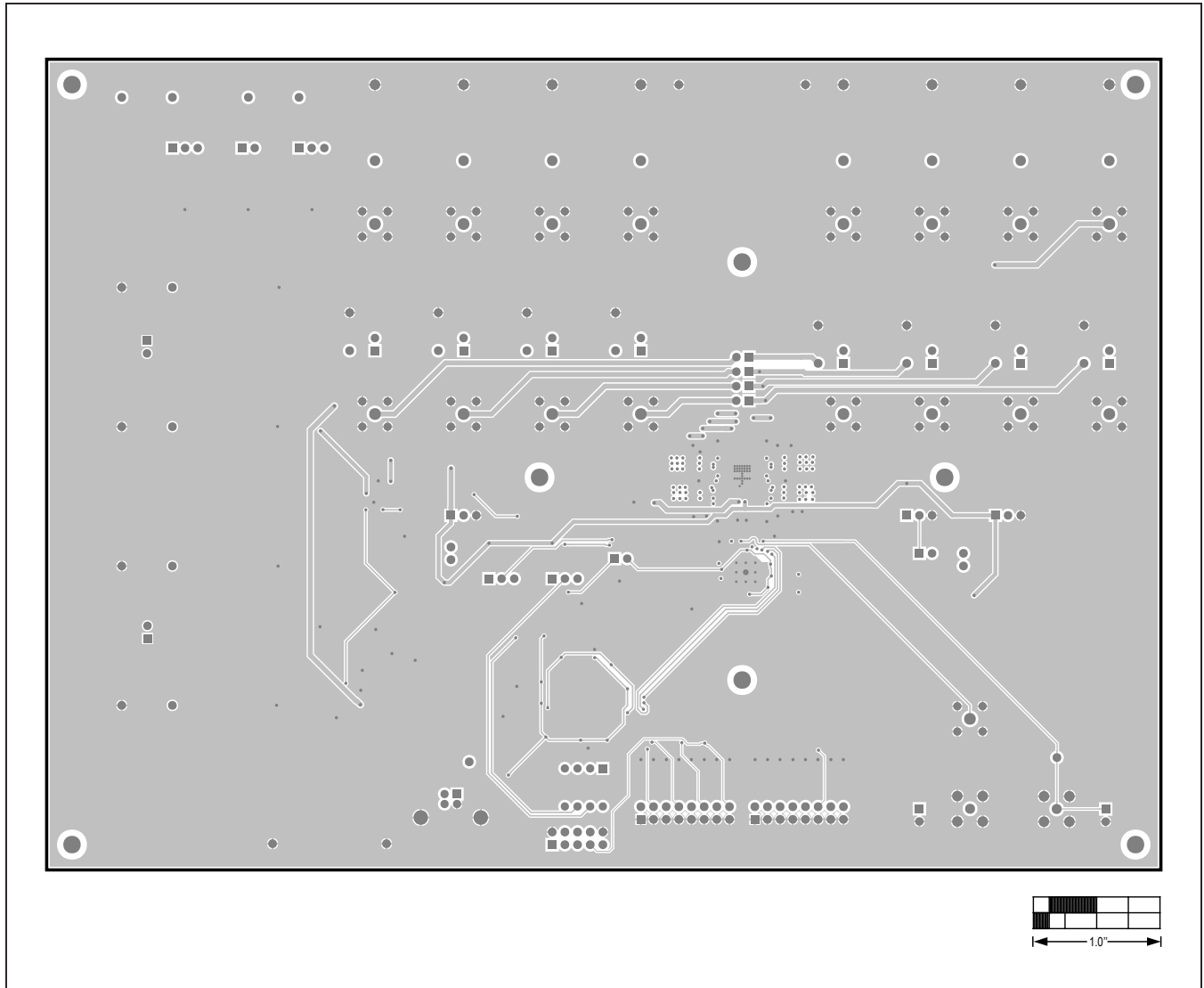

MAX14813 EV PCB Layout (continued)

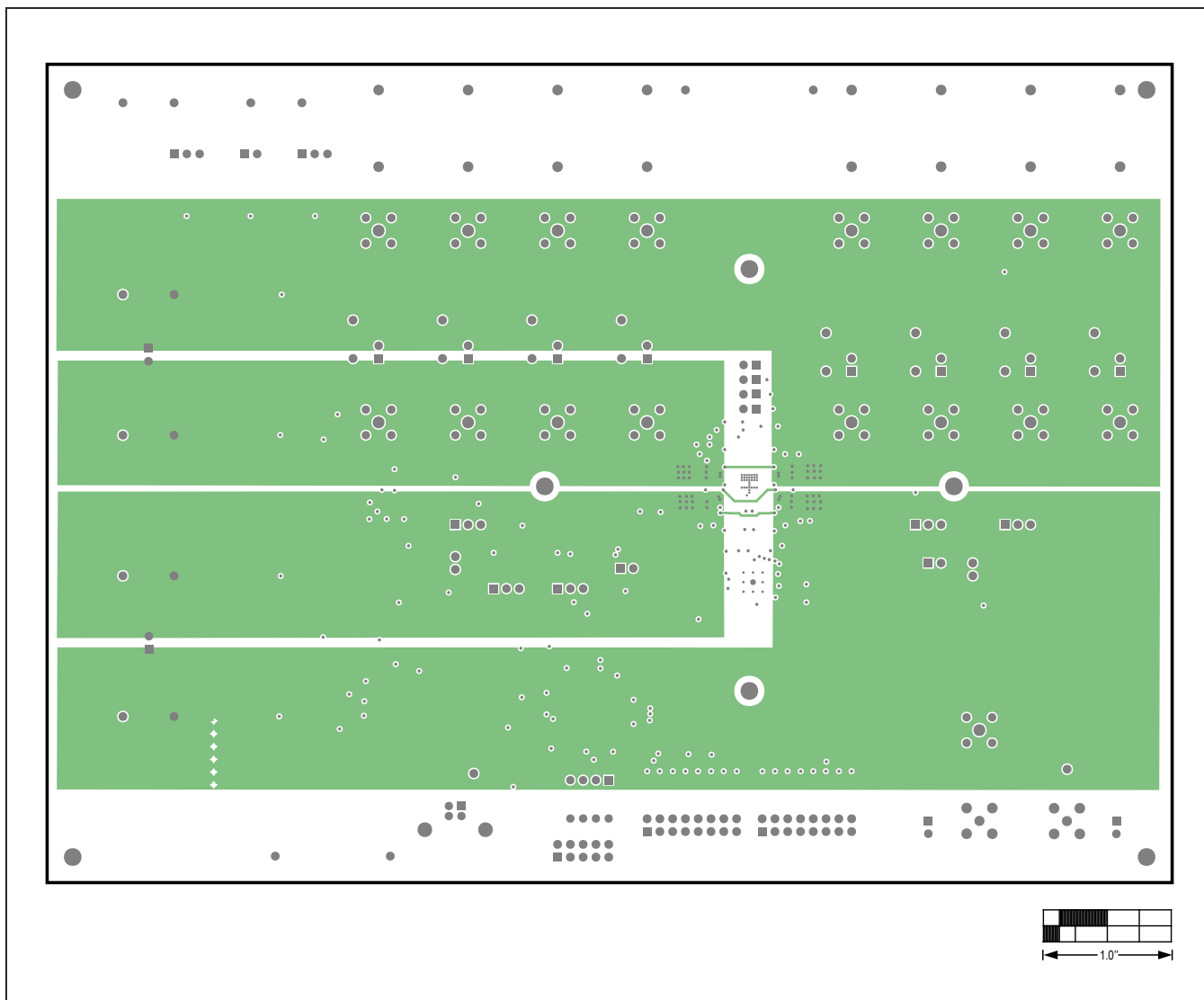

MAX14813 EV PCB Layout (continued)

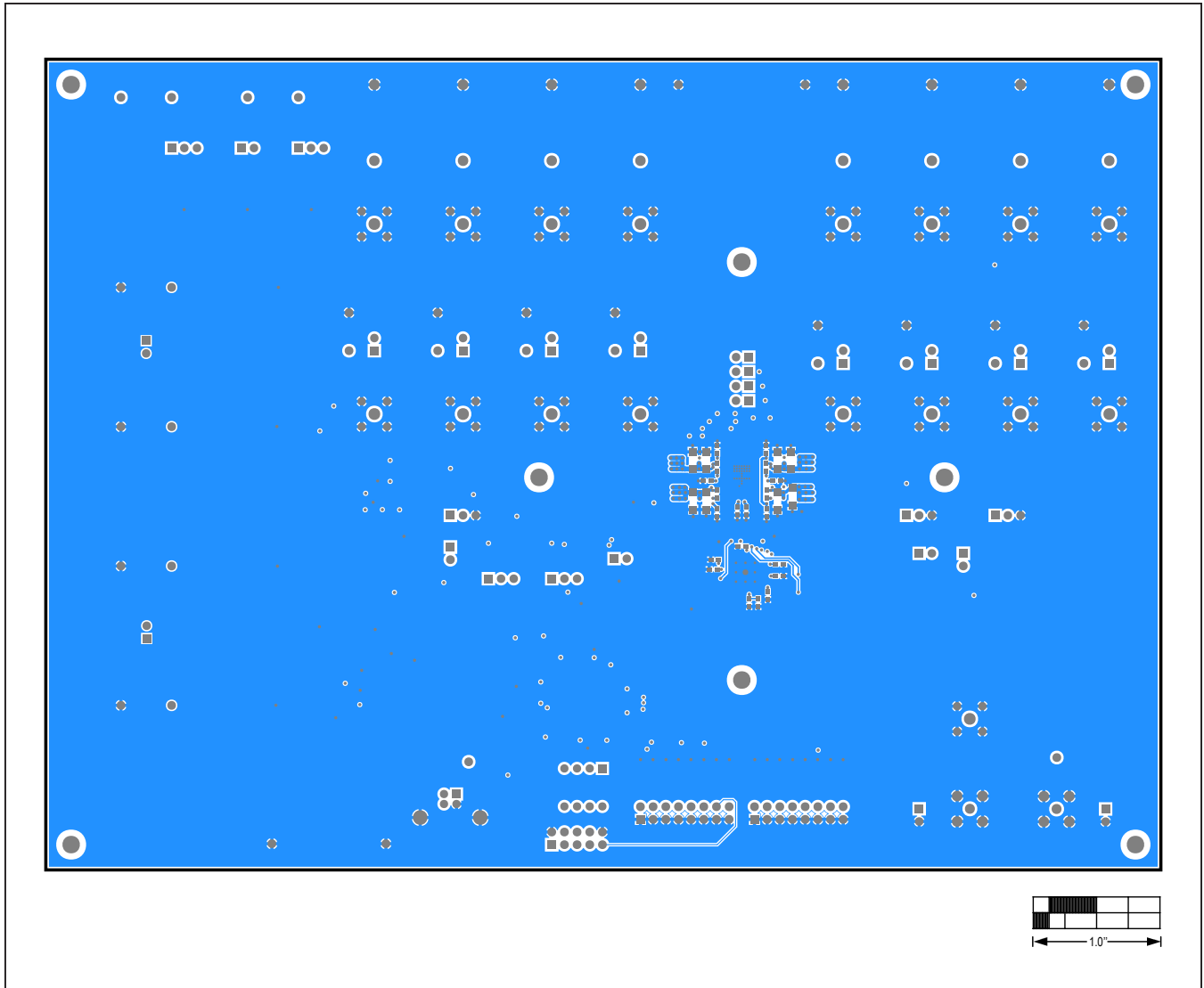

MAX14813 EV PCB Layout (continued)

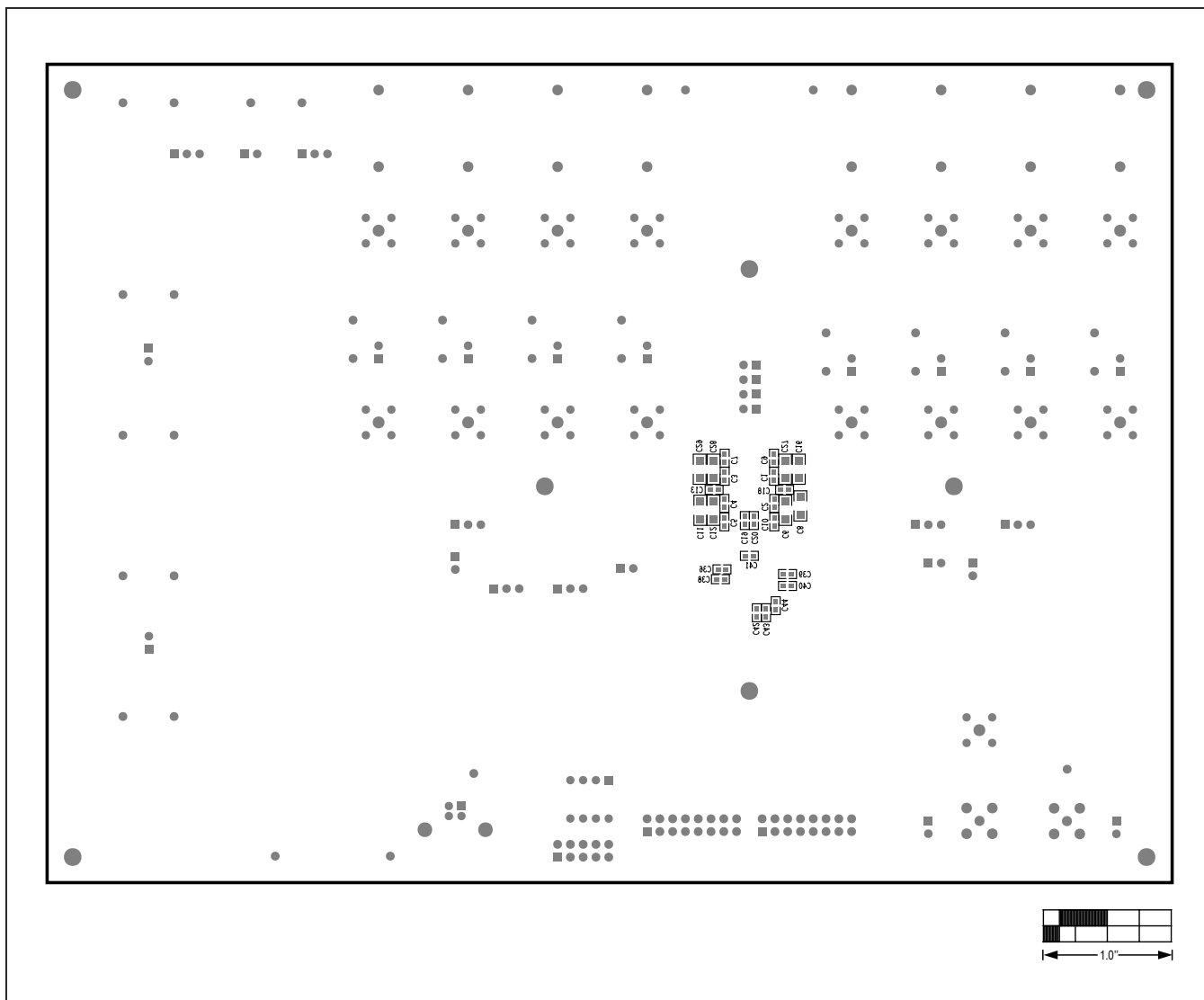

Revision History

REVISION NUMBER	REVISION DATE	DESCRIPTION	PAGES CHANGED
0	10/16	Initial release	—
.1		Corrected typo in the <i>Ordering Information</i> table	15

For pricing, delivery, and ordering information, please visit Maxim Integrated's online storefront at <https://www.maximintegrated.com/en/storefront/storefront.html>.

Maxim Integrated cannot assume responsibility for use of any circuitry other than circuitry entirely embodied in a Maxim Integrated product. No circuit patent licenses are implied. Maxim Integrated reserves the right to change the circuitry and specifications without notice at any time.