

**Data sheet | Item number: 880-681/999-940**

3-conductor through terminal block; 4 mm<sup>2</sup>; with test port; without shield contact; center marking; for DIN-rail 35 x 15 and 35 x 7.5; CAGE CLAMP®; 4,00 mm<sup>2</sup>; gray

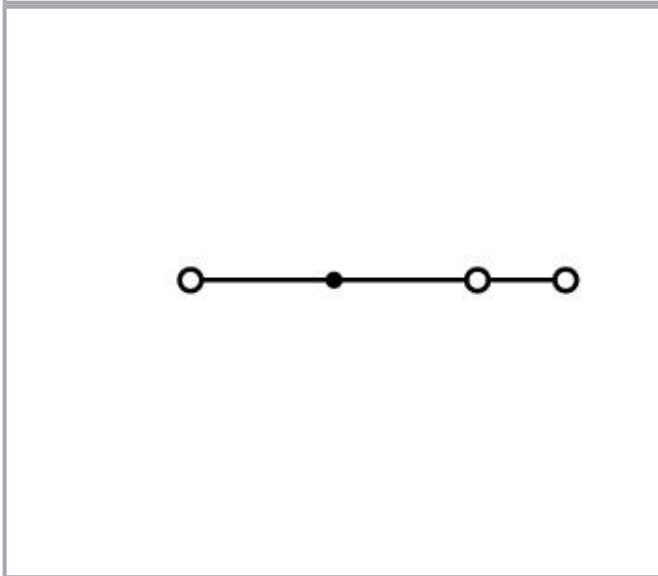

[www.wago.com/880-681/999-940](http://www.wago.com/880-681/999-940)

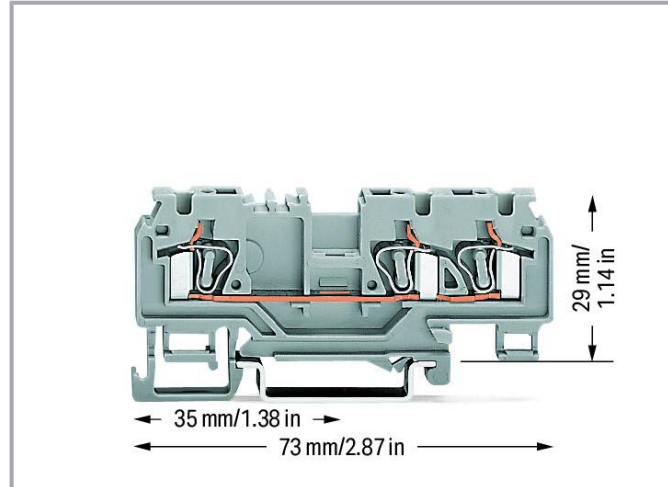
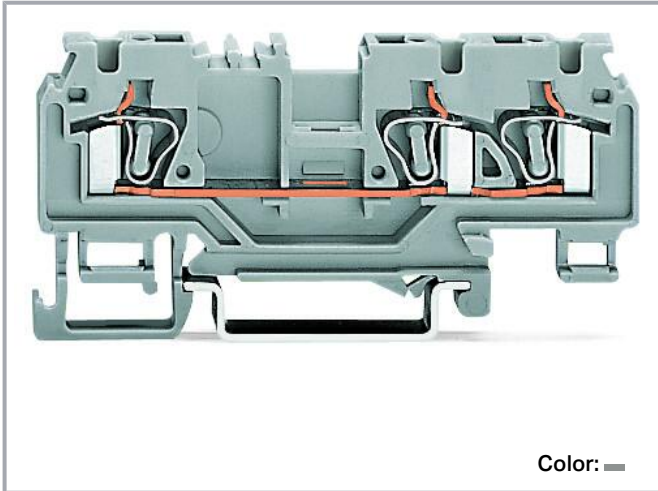

**Data**

**Electrical data**

**Ratings per IEC/EN**

Ratings per	IEC/EN 60947-7-1
Nominal voltage (III/3)	800 V

Subject to changes. Please also observe the further product documentation!

WAGO GmbH & Co. KG  
Hansastr. 27  
32423 Minden  
Phone: +49571 887-0 | Fax: +49571 887-169  
Email: [info.de@wago.com](mailto:info.de@wago.com) | Web: [www.wago.com](http://www.wago.com)

Do you have any questions about our products?  
We are always happy to take your call at +49 (571) 887-44222.



Rated impulse voltage (III/3)	8 kV
Rated current	25 A
Legend (ratings)	(III / 3) ≙ Overvoltage category III / Pollution degree 3

### Power loss

Power loss, per pole (potential)	0.625 W
Rated current $I_N$ for specified power loss	25 A
Resistance value for specified, current-dependent power loss	0.001 $\Omega$

### Connection data

Connection points	3
Total number of potentials	1
Number of levels	1

### Connection 1

Connection technology	CAGE CLAMP®
Actuation type	Operating tool
Connectable conductor materials	Copper
Solid conductor	0.08 ... 4 mm <sup>2</sup> / 28 ... 12 AWG
Fine-stranded conductor	0.08 ... 4 mm <sup>2</sup> / 28 ... 12 AWG
Strip length	8 ... 9 mm / 0.31 ... 0.35 inches
Wiring direction	Front-entry wiring

### Physical data

Width	5 mm / 0.197 inches
Height	73 mm / 2.874 inches
Depth from upper-edge of DIN-rail	29 mm / 1.142 inches

### Mechanical Data

Mounting type	DIN-35 rail
Marking level	Center marking

### Material Data

Note (material data)

[Information on material specifications can be found here](#)

Subject to changes. Please also observe the further product documentation!



Color	gray
Material group	I
Insulation material	Polyamide (PA66)
Flammability class per UL94	V0
Fire load	0.289 MJ
Weight	8.7 g

### Environmental requirements

Processing temperature	-35 ... +85 °C
Continuous operating temperature	-60 ... +105 °C

### Commercial data



Product Group	1 (Rail Mounted Terminal Blocks)
eCl@ss 10.0	27-14-11-20
eCl@ss 9.0	27-14-11-20
ETIM 8.0	EC000897
ETIM 7.0	EC000897
PU (SPU)	100 pcs
Packaging type	box
Country of origin	PL
GTIN	4044918519939
Customs tariff number	85369010000

### Environmental Product Compliance

RoHS Compliance Status	Compliant, No Exemption
------------------------	-------------------------

### Approvals / Certificates

#### General approvals

Logo	Approval	Additional Approval Text	Certificate name
	CCA DEKRA Certification B.V.	EN 60947	2174152.01
	CCA DEKRA Certification B.V.	EN 60947	NTR-NL 7339

Subject to changes. Please also observe the further product documentation!





UL  
Underwriters Laboratories Inc.



UL 1059

E45172

### Declarations of conformity and manufacturer's declarations

Logo	Approval	Additional Approval Text	Certificate name
	EU-Declaration of Conformity WAGO GmbH & Co. KG	-	-
	UK-Declaration of Conformity WAGO GmbH & Co. KG	-	-

### Approvals for marine applications

Logo	Approval	Additional Approval Text	Certificate name
	ABS American Bureau of Shipping	EN 60947	20- HG1941090- PDA
	DNV GL Det Norske Veritas, Germanischer Lloyd	-	TAE00001V2

### Required accessories

#### End plate

End plate



Item no.: 880-308  
End and intermediate plate; 2.5 mm thick; gray

[www.wago.com/880-308](http://www.wago.com/880-308)

Item no.: 880-339  
End and intermediate plate; 2.5 mm thick; orange

[www.wago.com/880-339](http://www.wago.com/880-339)

### Optional accessories

#### Jumpers

Jumper

Item no.: 210-123

Subject to changes. Please also observe the further product documentation!

WAGO GmbH & Co. KG  
Hansastr. 27  
32423 Minden  
Phone: +49571 887-0 | Fax: +49571 887-169  
Email: [info.de@wago.com](mailto:info.de@wago.com) | Web: [www.wago.com](http://www.wago.com)

Do you have any questions about our products?  
We are always happy to take your call at +49 (571) 887-44222.

	Wire commoning chain; insulated; blue	<a href="http://www.wago.com/210-123">www.wago.com/210-123</a>
	<b>Item no.: 280-402</b> Jumper; insulated; gray	<a href="http://www.wago.com/280-402">www.wago.com/280-402</a>
	<b>Item no.: 210-103</b> Wire commoning chain; insulated; black	<a href="http://www.wago.com/210-103">www.wago.com/210-103</a>
	<b>Item no.: 280-409</b> Jumper; insulated; gray	<a href="http://www.wago.com/280-409">www.wago.com/280-409</a>
	<b>Item no.: 280-422</b> Jumper; insulated; yellow-green	<a href="http://www.wago.com/280-422">www.wago.com/280-422</a>
	<b>Item no.: 709-110</b> Wire commoning chain; 2.5 mm <sup>2</sup> ; insulated; black	<a href="http://www.wago.com/709-110">www.wago.com/709-110</a>
	<b>Item no.: 709-112</b> Wire commoning chain; 2.5 mm <sup>2</sup> ; insulated; black	<a href="http://www.wago.com/709-112">www.wago.com/709-112</a>
	<b>Item no.: 709-111</b> Wire commoning chain; 2.5 mm <sup>2</sup> ; insulated; black	<a href="http://www.wago.com/709-111">www.wago.com/709-111</a>
	<b>Item no.: 780-454</b> Staggered jumper; from 1 to 4; insulated; gray	<a href="http://www.wago.com/780-454">www.wago.com/780-454</a>
	<b>Item no.: 780-452</b> Staggered jumper; from 1 to 2; insulated; gray	<a href="http://www.wago.com/780-452">www.wago.com/780-452</a>
	<b>Item no.: 780-453</b> Staggered jumper; from 1 to 3; insulated; gray	<a href="http://www.wago.com/780-453">www.wago.com/780-453</a>
	<b>Item no.: 780-457</b> Staggered jumper; from 1 to 7; insulated; gray	<a href="http://www.wago.com/780-457">www.wago.com/780-457</a>
	<b>Item no.: 780-456</b> Staggered jumper; from 1 to 6; insulated; gray	<a href="http://www.wago.com/780-456">www.wago.com/780-456</a>
	<b>Item no.: 780-455</b> Staggered jumper; from 1 to 5; insulated; gray	<a href="http://www.wago.com/780-455">www.wago.com/780-455</a>
	<b>Item no.: 780-458</b> Staggered jumper; from 1 to 8; insulated; gray	<a href="http://www.wago.com/780-458">www.wago.com/780-458</a>
<b>Testing and measuring</b>		
Testing accessories		
	<b>Item no.: 209-170</b> Test plug adapter; 8.3 mm wide; for 4 mm Ø test plugs; suitable for 1.5 mm <sup>2</sup> - 10 mm <sup>2</sup> tbs; gray	<a href="http://www.wago.com/209-170">www.wago.com/209-170</a>

Subject to changes. Please also observe the further product documentation!



**Item no.: 210-136**  
Test plug; 2 mm Ø; with 500 mm cable; red

[www.wago.com/210-136](http://www.wago.com/210-136)



**Item no.: 281-407**  
Test plug; 6 mm wide; Nominal current 24 A; for 0.08 mm<sup>2</sup> - 2.5 mm<sup>2</sup>; 2,50 mm<sup>2</sup>; gray

[www.wago.com/281-407](http://www.wago.com/281-407)



**Item no.: 249-106**  
B-type test plug module; modular; 1,50 mm<sup>2</sup>; gray

[www.wago.com/249-106](http://www.wago.com/249-106)



**Item no.: 249-107**  
B-type spacer module; modular; e.g., for bridging commoned terminal blocks; gray

[www.wago.com/249-107](http://www.wago.com/249-107)



**Item no.: 280-418**  
Test plug module; modular; suitable for all WAGO 280 and 780 Series rail-mounted terminal blocks with jumper slots in the current bar; gray

[www.wago.com/280-418](http://www.wago.com/280-418)



**Item no.: 280-404**  
Test plug adapter; 5 mm wide; for test plug (2.3 mm Ø); suitable for 1.5 mm<sup>2</sup> - 4 mm<sup>2</sup> tbs; gray

[www.wago.com/280-404](http://www.wago.com/280-404)



**Item no.: 280-419**  
Spacer module; modular; bridging commoned terminal blocks; gray

[www.wago.com/280-419](http://www.wago.com/280-419)

#### Push-in type wire jumper

Jumper



**Item no.: 249-123**  
Push-in type wire jumper; 0.75 mm<sup>2</sup>; insulated; 180 mm long; black

[www.wago.com/249-123](http://www.wago.com/249-123)



**Item no.: 249-126**  
Push-in type wire jumper; 0.75 mm<sup>2</sup>; insulated; 110 mm long; black

[www.wago.com/249-126](http://www.wago.com/249-126)



**Item no.: 249-127**  
Push-in type wire jumper; 0.75 mm<sup>2</sup>; insulated; 250 mm long; black

[www.wago.com/249-127](http://www.wago.com/249-127)



**Item no.: 249-125**  
Push-in type wire jumper; insulated; 60 mm long; black

[www.wago.com/249-125](http://www.wago.com/249-125)

#### Insulation stop

Insulation stop



**Item no.: 280-472**  
Insulation stop; 0.75 - 1 mm<sup>2</sup>; 5 pieces/strip; black

[www.wago.com/280-472](http://www.wago.com/280-472)



**Item no.: 280-470**  
Insulation stop; 0.08 - 0.2 mm<sup>2</sup> "s" (0.14 mm<sup>2</sup> "f-st"); 5 pieces/strip; white

[www.wago.com/280-470](http://www.wago.com/280-470)



**Item no.: 280-471**  
Insulation stop; 0.25 - 0.5 mm<sup>2</sup>; 5 pieces/strip; light gray

[www.wago.com/280-471](http://www.wago.com/280-471)

#### End plate

End plate



**Item no.: 880-340**

Subject to changes. Please also observe the further product documentation!

Separator plate; 2 mm thick; oversized; orange

[www.wago.com/880-340](http://www.wago.com/880-340)



**Item no.: 880-309**

Separator plate; 2 mm thick; oversized; gray

[www.wago.com/880-309](http://www.wago.com/880-309)

**Marking accessories**

Marker



**Item no.: 2009-115/000-002**

WMB-Inline; for Smart Printer; 1500 pieces on roll; stretchable 5 - 5.2 mm; plain; snap-on type; yellow

[www.wago.com/2009-115/000-002](http://www.wago.com/2009-115/000-002)



**Item no.: 2009-115/000-007**

WMB-Inline; for Smart Printer; 1500 pieces on roll; stretchable 5 - 5.2 mm; plain; snap-on type; gray

[www.wago.com/2009-115/000-007](http://www.wago.com/2009-115/000-007)



**Item no.: 2009-115/000-017**

WMB-Inline; for Smart Printer; 1500 pieces on roll; stretchable 5 - 5.2 mm; plain; snap-on type; light green

[www.wago.com/2009-115/000-017](http://www.wago.com/2009-115/000-017)



**Item no.: 2009-115/000-023**

WMB-Inline; for Smart Printer; 1500 pieces on roll; stretchable 5 - 5.2 mm; plain; snap-on type; green

[www.wago.com/2009-115/000-023](http://www.wago.com/2009-115/000-023)



**Item no.: 2009-115/000-024**

WMB-Inline; for Smart Printer; 1500 pieces on roll; stretchable 5 - 5.2 mm; plain; snap-on type; violet

[www.wago.com/2009-115/000-024](http://www.wago.com/2009-115/000-024)

**Item no.: 2009-145/000-006**

Mini-WSB Inline; for Smart Printer; 1700 pieces on roll; stretchable 5 - 5.2 mm; plain; snap-on type; blue

[www.wago.com/2009-145/000-006](http://www.wago.com/2009-145/000-006)

**Item no.: 2009-145**

Mini-WSB Inline; for Smart Printer; 1700 pieces on roll; stretchable 5 - 5.2 mm; plain; snap-on type; white

[www.wago.com/2009-145](http://www.wago.com/2009-145)

**Item no.: 2009-145/000-002**

Mini-WSB Inline; for Smart Printer; 1700 pieces on roll; stretchable 5 - 5.2 mm; plain; snap-on type; yellow

[www.wago.com/2009-145/000-002](http://www.wago.com/2009-145/000-002)

**Item no.: 2009-145/000-007**

Mini-WSB Inline; for Smart Printer; 1700 pieces on roll; stretchable 5 - 5.2 mm; plain; snap-on type; gray

[www.wago.com/2009-145/000-007](http://www.wago.com/2009-145/000-007)

**Item no.: 2009-145/000-005**

Mini-WSB Inline; for Smart Printer; 1700 pieces on roll; stretchable 5 - 5.2 mm; plain; snap-on type; red

[www.wago.com/2009-145/000-005](http://www.wago.com/2009-145/000-005)

**Item no.: 2009-145/000-012**

Mini-WSB Inline; for Smart Printer; 1700 pieces on roll; stretchable 5 - 5.2 mm; plain; snap-on type; orange

[www.wago.com/2009-145/000-012](http://www.wago.com/2009-145/000-012)

Subject to changes. Please also observe the further product documentation!

WAGO GmbH & Co. KG

Hansastr. 27













32423 Minden

Phone: +49571 887-0 | Fax: +49571 887-169

Email: [info.de@wago.com](mailto:info.de@wago.com) | Web: [www.wago.com](http://www.wago.com)

Do you have any questions about our products?

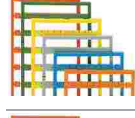
We are always happy to take your call at +49 (571) 887-44222.

	<b>Item no.: 2009-145/000-023</b> Mini-WSB Inline; for Smart Printer; 1700 pieces on roll; stretchable 5 - 5.2 mm; plain; snap-on type; green	<a href="http://www.wago.com/2009-145/000-023">www.wago.com/2009-145/000-023</a>
	<b>Item no.: 2009-145/000-024</b> Mini-WSB Inline; for Smart Printer; 1700 pieces on roll; stretchable 5 - 5.2 mm; plain; snap-on type; violet	<a href="http://www.wago.com/2009-145/000-024">www.wago.com/2009-145/000-024</a>
	<b>Item no.: 2009-115</b> WMB-Inline; for Smart Printer; 1500 pieces on roll; stretchable 5 - 5.2 mm; plain; snap-on type; white	<a href="http://www.wago.com/2009-115">www.wago.com/2009-115</a>
	<b>Item no.: 248-501/000-006</b> Mini-WSB marking card; as card; not stretchable; plain; snap-on type; blue	<a href="http://www.wago.com/248-501/000-006">www.wago.com/248-501/000-006</a>
	<b>Item no.: 248-501/000-007</b> Mini-WSB marking card; as card; not stretchable; plain; snap-on type; gray	<a href="http://www.wago.com/248-501/000-007">www.wago.com/248-501/000-007</a>
	<b>Item no.: 248-501/000-002</b> Mini-WSB marking card; as card; not stretchable; plain; snap-on type; yellow	<a href="http://www.wago.com/248-501/000-002">www.wago.com/248-501/000-002</a>
	<b>Item no.: 248-501/000-012</b> Mini-WSB marking card; as card; not stretchable; plain; snap-on type; orange	<a href="http://www.wago.com/248-501/000-012">www.wago.com/248-501/000-012</a>
	<b>Item no.: 248-501</b> Mini-WSB marking card; as card; not stretchable; plain; snap-on type; white	<a href="http://www.wago.com/248-501">www.wago.com/248-501</a>
	<b>Item no.: 248-501/000-017</b> Mini-WSB marking card; as card; not stretchable; plain; snap-on type; light green	<a href="http://www.wago.com/248-501/000-017">www.wago.com/248-501/000-017</a>
	<b>Item no.: 248-501/000-005</b> Mini-WSB marking card; as card; not stretchable; plain; snap-on type; red	<a href="http://www.wago.com/248-501/000-005">www.wago.com/248-501/000-005</a>
	<b>Item no.: 248-501/000-024</b> Mini-WSB marking card; as card; not stretchable; plain; snap-on type; violet	<a href="http://www.wago.com/248-501/000-024">www.wago.com/248-501/000-024</a>
	<b>Item no.: 248-501/000-023</b> Mini-WSB marking card; as card; not stretchable; plain; snap-on type; green	<a href="http://www.wago.com/248-501/000-023">www.wago.com/248-501/000-023</a>

Subject to changes. Please also observe the further product documentation!





**Item no.:** 793-5501/000-007

WMB marking card; as card; for terminal block width 5 - 17.5 mm; stretchable 5 - 5.2 mm; plain; snap-on type; gray [www.wago.com/793-5501/000-007](http://www.wago.com/793-5501/000-007)



**Item no.:** 793-5501/000-012

WMB marking card; as card; for terminal block width 5 - 17.5 mm; stretchable 5 - 5.2 mm; plain; snap-on type; orange [www.wago.com/793-5501/000-012](http://www.wago.com/793-5501/000-012)



**Item no.:** 793-5501/000-017

WMB marking card; as card; for terminal block width 5 - 17.5 mm; stretchable 5 - 5.2 mm; plain; snap-on type; light green [www.wago.com/793-5501/000-017](http://www.wago.com/793-5501/000-017)



**Item no.:** 793-5501/000-023

WMB marking card; as card; for terminal block width 5 - 17.5 mm; stretchable 5 - 5.2 mm; plain; snap-on type; green [www.wago.com/793-5501/000-023](http://www.wago.com/793-5501/000-023)



**Item no.:** 793-5501/000-024

WMB marking card; as card; for terminal block width 5 - 17.5 mm; stretchable 5 - 5.2 mm; plain; snap-on type; violet [www.wago.com/793-5501/000-024](http://www.wago.com/793-5501/000-024)



**Item no.:** 793-501/000-002

WMB marking card; as card; not stretchable; plain; snap-on type; yellow [www.wago.com/793-501/000-002](http://www.wago.com/793-501/000-002)



**Item no.:** 793-501/000-007

WMB marking card; as card; not stretchable; plain; snap-on type; gray [www.wago.com/793-501/000-007](http://www.wago.com/793-501/000-007)



**Item no.:** 793-501/000-017

WMB marking card; as card; not stretchable; plain; snap-on type; light green [www.wago.com/793-501/000-017](http://www.wago.com/793-501/000-017)

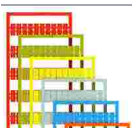

**Item no.:** 793-501/000-012

WMB marking card; as card; not stretchable; plain; snap-on type; orange [www.wago.com/793-501/000-012](http://www.wago.com/793-501/000-012)

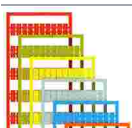

**Item no.:** 793-501/000-023

WMB marking card; as card; not stretchable; plain; snap-on type; green [www.wago.com/793-501/000-023](http://www.wago.com/793-501/000-023)

Subject to changes. Please also observe the further product documentation!

WAGO GmbH & Co. KG

Hansastr. 27

32423 Minden

Phone: +49571 887-0 | Fax: +49571 887-169

Email: [info.de@wago.com](mailto:info.de@wago.com) | Web: [www.wago.com](http://www.wago.com)

Do you have any questions about our products?

We are always happy to take your call at +49 (571) 887-44222.



**Item no.: 793-501/000-006**  
WMB marking card; as card; not stretchable; plain; snap-on type; blue

[www.wago.com/793-501/000-006](http://www.wago.com/793-501/000-006)



**Item no.: 793-501/000-005**  
WMB marking card; as card; not stretchable; plain; snap-on type; red

[www.wago.com/793-501/000-005](http://www.wago.com/793-501/000-005)



**Item no.: 793-501**  
WMB marking card; as card; not stretchable; plain; snap-on type; white

[www.wago.com/793-501](http://www.wago.com/793-501)



**Item no.: 793-501/000-024**  
WMB marking card; as card; not stretchable; plain; snap-on type; violet

[www.wago.com/793-501/000-024](http://www.wago.com/793-501/000-024)



**Item no.: 793-5501/000-005**  
WMB marking card; as card; for terminal block width 5 - 17.5 mm; stretchable 5 - 5.2 mm; plain; snap-on type; red

[www.wago.com/793-5501/000-005](http://www.wago.com/793-5501/000-005)



**Item no.: 793-5501/000-002**  
WMB marking card; as card; for terminal block width 5 - 17.5 mm; stretchable 5 - 5.2 mm; plain; snap-on type; yellow

[www.wago.com/793-5501/000-002](http://www.wago.com/793-5501/000-002)



**Item no.: 793-5501/000-006**  
WMB marking card; as card; for terminal block width 5 - 17.5 mm; stretchable 5 - 5.2 mm; plain; snap-on type; blue

[www.wago.com/793-5501/000-006](http://www.wago.com/793-5501/000-006)



**Item no.: 793-5501**  
WMB marking card; as card; for terminal block width 5 - 17.5 mm; stretchable 5 - 5.2 mm; plain; snap-on type; white

[www.wago.com/793-5501](http://www.wago.com/793-5501)



**Item no.: 2009-115/000-012**  
WMB-Inline; for Smart Printer; 1500 pieces on roll; stretchable 5 - 5.2 mm; plain; snap-on type; orange

[www.wago.com/2009-115/000-012](http://www.wago.com/2009-115/000-012)



**Item no.: 2009-115/000-006**  
WMB-Inline; for Smart Printer; 1500 pieces on roll; stretchable 5 - 5.2 mm; plain; snap-on type; blue

[www.wago.com/2009-115/000-006](http://www.wago.com/2009-115/000-006)

#### Group marker carrier



**Item no.: 249-105**  
Group marker carrier; gray

[www.wago.com/249-105](http://www.wago.com/249-105)

#### Mounting

Cover carrier

Subject to changes. Please also observe the further product documentation!



**Item no.: 709-167**

Cover carrier; Type 1; incl. fixing/retaining screws and knurled nut; suitable for 279 to 282 and 880 Series rail-mounted terminal blocks; suitable for 264 Series miniature rail-mounted terminal blocks; suitable for 270 Series sensor and actuator terminal blocks; gray

[www.wago.com/709-167](http://www.wago.com/709-167)

Cover



**Item no.: 709-153**

Cover; Type 1; suitable for cover carrier, type 1; 1 m long; transparent

[www.wago.com/709-153](http://www.wago.com/709-153)

Mounting accessories



**Item no.: 209-106**

Mounting carrier; for isolated mounting on DIN 35 rails; gray

[www.wago.com/209-106](http://www.wago.com/209-106)



**Item no.: 249-116**

Screwless end stop; 6 mm wide; for DIN-rail 35 x 15 and 35 x 7.5; gray

[www.wago.com/249-116](http://www.wago.com/249-116)

**Protective warning marker**

Cover



**Item no.: 280-415**

Protective warning marker; for 5 terminal blocks; with high-voltage symbol, black; yellow

[www.wago.com/280-415](http://www.wago.com/280-415)

**Carrier rail**

Mounting accessories



**Item no.: 210-197**

Steel carrier rail; 35 x 15 mm; 1.5 mm thick; 2 m long; slotted; similar to EN 60715; silver-colored

[www.wago.com/210-197](http://www.wago.com/210-197)



**Item no.: 210-198**

Copper carrier rail; 35 x 15 mm; 2.3 mm thick; 2 m long; unslotted; according to EN 60715; copper-colored

[www.wago.com/210-198](http://www.wago.com/210-198)



**Item no.: 210-504**

Steel carrier rail; 35 x 7.5 mm; 1 mm thick; 2 m long; slotted; galvanized; according to EN 60715; silver-colored

[www.wago.com/210-504](http://www.wago.com/210-504)



**Item no.: 210-505**

Steel carrier rail; 35 x 7.5 mm; 1 mm thick; 2 m long; unslotted; galvanized; according to EN 60715; silver-colored

[www.wago.com/210-505](http://www.wago.com/210-505)



**Item no.: 210-506**

Steel carrier rail; 35 x 15 mm; 1.5 mm thick; 2 m long; unslotted; galvanized; similar to EN 60715; silver-colored

[www.wago.com/210-506](http://www.wago.com/210-506)



**Item no.: 210-508**

Steel carrier rail; 35 x 15 mm; 1.5 mm thick; 2 m long; slotted; galvanized; similar to EN 60715; silver-colored

[www.wago.com/210-508](http://www.wago.com/210-508)



**Item no.: 210-113**

Steel carrier rail; 35 x 7.5 mm; 1 mm thick; 2 m long; unslotted; according to EN 60715; silver-colored

[www.wago.com/210-113](http://www.wago.com/210-113)

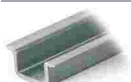

**Item no.: 210-118**

Steel carrier rail; 35 x 15 mm; 2.3 mm thick; 2 m long; unslotted; according to EN 60715; silver-colored

[www.wago.com/210-118](http://www.wago.com/210-118)

Subject to changes. Please also observe the further product documentation!

WAGO GmbH & Co. KG

Hansastr. 27

32423 Minden

Phone: +49571 887-0 | Fax: +49571 887-169

Email: [info.de@wago.com](mailto:info.de@wago.com) | Web: [www.wago.com](http://www.wago.com)

Do you have any questions about our products?

We are always happy to take your call at +49 (571) 887-44222.



**Item no.: 210-112**

Steel carrier rail; 35 x 7.5 mm; 1 mm thick; 2 m long; slotted; according to EN 60715; "Hole width 25 mm; [www.wago.com/210-112](http://www.wago.com/210-112)  
silver-colored



**Item no.: 210-114**

Steel carrier rail; 35 x 15 mm; 1.5 mm thick; 2 m long; unslotted; similar to EN 60715; silver-colored [www.wago.com/210-114](http://www.wago.com/210-114)



**Item no.: 210-115**

Steel carrier rail; 35 x 7.5 mm; 1 mm thick; 2 m long; slotted; according to EN 60715; "Hole width 18 mm; [www.wago.com/210-115](http://www.wago.com/210-115)  
silver-colored

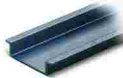

**Item no.: 210-196**

Aluminum carrier rail; 35 x 8.2 mm; 1.6 mm thick; 2 m long; unslotted; similar to EN 60715; silver-colored [www.wago.com/210-196](http://www.wago.com/210-196)

**Ferrule**

Ferrule



**Item no.: 216-206**

Ferrule; Sleeve for 2.5 mm<sup>2</sup> / AWG 14; insulated; electro-tin plated; blue [www.wago.com/216-206](http://www.wago.com/216-206)

**Downloads**

**Documentation**

**Bid Text**

880-681/999-940 X81 - Datei	2019 Feb 19	xml 3.5 kB	Download
880-681/999-940 doc - Datei	2017 Feb 28	doc 25.1 kB	Download

**Additional Information**

Technical Section Technical explanations	pdf 2.2 MB	Download
---	---------------	----------

**CAD/CAE-Data**

**CAD data**

2D/3D Models 880-681/999-940	URL	Download
------------------------------	-----	----------

**CAE data**

EPLAN Data Portal 880-681/999-940	URL	Download
WSCAD Universe 880-681/999-940	URL	Download

Subject to changes. Please also observe the further product documentation!



ZUKEN Portal 880-681/999-940	<a href="#">URL</a>	<a href="#">Download</a>
WSCAD Universe 880-681/999-940	<a href="#">URL</a>	<a href="#">Download</a>
EPLAN Data Portal 880-681/999-940	<a href="#">URL</a>	<a href="#">Download</a>

## Environmental Product Compliance

### Compliance Search

Environmental Product Compliance 880-681/999-940	<a href="#">URL</a>	<a href="#">Download</a>
3-conductor through terminal block; 4 mm <sup>2</sup> ; with test port; without shield contact; center marking; for DIN-rail 35 x 15 and 35 x 7.5; CAGE CLAMP®; 4,00 mm <sup>2</sup> ; gray		

## Installation Notes

Subject to changes. Please also observe the further product documentation!

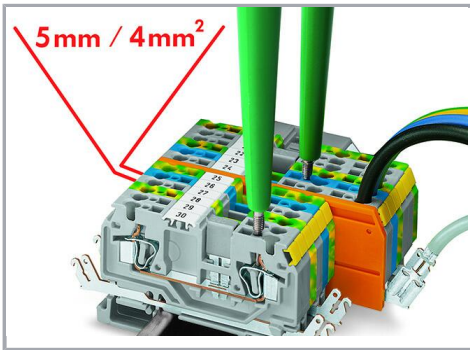

## Features

- 2-, 3- and 4-conductor terminal blocks, just 5 mm wide
- Conductor cross-sections up to 4 mm<sup>2</sup> (per VDE 0281) or 12 AWG with ferrule (Item No. 216-206) 2.5 mm<sup>2</sup> rubber-insulated conductors with outer diameter up to 4.4 mm
- Shield contact via 6.3 (2 x 2.8) mm solder/crimp quick disconnect terminal
- Test plug, red, 2 mm Ø
- WMB markers
- Mini-WSB markers, on both sides
- Commoning with WAGO jumper systems

## Conductor termination

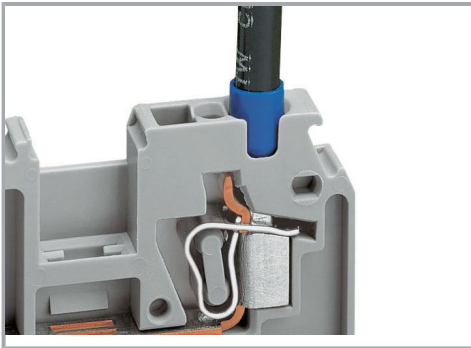

Using a 12 AWG conductor with ferrule (Item No. 216-206).

## Testing

Subject to changes. Please also observe the further product documentation!

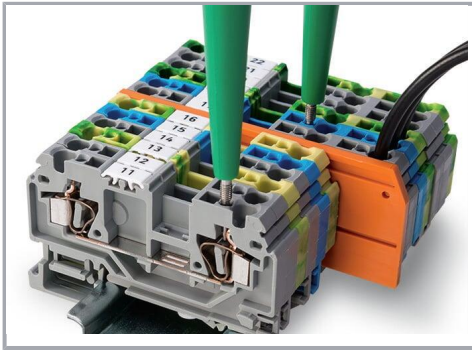

880 Series Terminal Blocks have an additional test slot for voltage tester.

## Product family

### Classic

EPSITRON® CLASSIC POWER: The Robust Power Supply – with Integrated TopBoost (Optional)

[Show all products from the family](#)

Subject to changes. Please also observe the further product documentation!