



User Manual

ARK-6320

**Fanless Wallmount / Desktop
Mini-ITX Embedded Computer**

Trusted ePlatform Services

ADVANTECH

Copyright

The documentation and the software included with this product are copyrighted 2010 by Advantech Co., Ltd. All rights are reserved. Advantech Co., Ltd. reserves the right to make improvements in the products described in this manual at any time without notice. No part of this manual may be reproduced, copied, translated or transmitted in any form or by any means without the prior written permission of Advantech Co., Ltd. Information provided in this manual is intended to be accurate and reliable. However, Advantech Co., Ltd. assumes no responsibility for its use, nor for any infringements of the rights of third parties, which may result from its use.

Acknowledgements

The ARK-6320 is trademark of Advantech Co., Ltd.

AWARD is a trademark of Phoenix Technologies Ltd.

IBM and PC are trademarks of International Business Machines Corporation.

Intel® Atom™ D510, D525 is trademark of Intel Corporation

Microsoft® Windows® and MS-DOS are registered trademarks of Microsoft Corp.

WinBond is a trademark of Winbond Corporation.

All other product names or trademarks are properties of their respective owners.

On-line Technical Support

For technical support and service, please visit our support website at:

<http://www.advantech.com/support>

Safety Instructions

1. Read these safety instructions carefully.
2. Keep this user manual for later reference.
3. Disconnect this equipment from AC outlet before cleaning. Do not use liquid or spray detergents for cleaning.
4. For pluggable equipment, the power outlet shall be installed near the equipment and shall be easily accessible.
5. Keep this equipment away from humidity.
6. Put this equipment on a reliable surface during installation. Dropping it or letting it fall could cause damage.
7. Do not leave this equipment in an environment unconditioned where the storage temperature under 0 °C (32 °F) or above 50 °C (122 °F), it may damage the equipment.
8. The openings on the enclosure are for air convection hence protects the equipment from overheating. **DO NOT COVER THE OPENINGS.**
9. Make sure the voltage of the power source is correct before connecting the equipment to the power outlet.
10. Place the power cord such a way that people can not step on it. Do not place anything over the power cord. The voltage and current rating of the cord should be greater than the voltage and current rating marked on the product.
11. All cautions and warnings on the equipment should be noted.
12. If the equipment is not used for long time, disconnect it from the power source to avoid being damaged by transient over-voltage.
13. Never pour any liquid into ventilation openings. This could cause fire or electrical shock.
14. Never open the equipment. For safety reasons, the equipment should be opened only by qualified service personnel.
15. If any of the following situations arises, get the equipment checked by service personnel:
 - The power cord or plug is damaged.
 - Liquid has penetrated into the equipment.
 - The equipment has been exposed to moisture.
 - The equipment does not work well or you cannot get it to work according to user manual.
 - The equipment has been dropped and damaged.
 - The equipment has obvious signs of breakage.
16. **CAUTION:** The computer is provided with a battery-powered real-time clock circuit. There is a danger of explosion if battery is incorrectly replaced. Replace only with same or equivalent type recommended by the manufacture. Discard used batteries according to the manufacturer's instructions.
17. THE COMPUTER IS PROVIDED WITH CD DRIVES COMPLY WITH APPROPRIATE SAFETY STANDARDS INCLUDING IEC 60825.

CLASS 1 LASER PRODUCT
KLASSE 1 LASER PRODUKT

18. This device complies with Part 15 of the FCC rules. Operation is subject to the following two conditions:
 - (1) this device may not cause harmful interference, and
 - (2) this device must accept any interference received, including interference that may cause undesired operation.
19. **CAUTION:** Always completely disconnect the power cord from your chassis whenever you work with the hardware. Do not make connections while the power is on. Sensitive electronic components can be damaged by sudden power surges.
20. **CAUTION:** Always ground yourself to remove any static charge before touching the motherboard, backplane, or add-on cards. Modern electronic devices are very sensitive to electrostatic discharges. As a safety precaution, use a grounding wrist strap at all times. Place all electronic components on a static-dissipative surface or in a static-shielded bag when they are not in the chassis.
21. **CAUTION:** Any unverified component could cause unexpected damage. To ensure the correct installation, please always use the components (ex. screws) provided with the accessory box.

Declaration of Conformity

CE

This product has passed the CE test for environmental specifications. Test conditions for passing included the equipment being operated within an industrial enclosure. In order to protect the product from being damaged by ESD (Electrostatic Discharge) and EMI leakage, we strongly recommend the use of CE-compliant industrial enclosure products.

FCC Class A

Note: This equipment has been tested and found to comply with the limits for a Class A digital device, pursuant to part 15 of the FCC Rules. These limits are designed to provide reasonable protection against harmful interference when the equipment is operated in a commercial environment. This equipment generates, uses, and can radiate radio frequency energy and, if not installed and used in accordance with the instruction manual, may cause harmful interference to radio communications. Operation of this equipment in a residential area is likely to cause harmful interference in which case the user will be required to correct the interference at his own expense.

A Message to the Customer

Advantech Customer Services

Each and every Advantech product is built to the most exacting specifications to ensure reliable performance in the harsh and demanding conditions typical of industrial environments. Whether your new Advantech equipment is destined for the laboratory or the factory floor, you can be assured that your product will provide the reliability and ease of operation for which the name Advantech has come to be known.

Your satisfaction is our primary concern. Here is a guide to Advantech's customer services. To ensure you get the full benefit of our services, please follow the instructions below carefully.

Technical Support

We want you to get the maximum performance from your products. So if you run into technical difficulties, we are here to help. For the most frequently asked questions, you can easily find answers in your product documentation. These answers are normally a lot more detailed than the ones we can give over the phone.

So please consult this manual first. If you still cannot find the answer, gather all the information or questions that apply to your problem, and with the product close at hand, call your dealer. Our dealers are well trained and ready to give you the support you need to get the most from your Advantech products. In fact, most problems reported are minor and are able to be easily solved over the phone.

In addition, free technical support is available from Advantech engineers every business day. We are always ready to give advice on application requirements or specific information on the installation and operation of any of our products.

Product Warranty

Advantech warrants to you, the original purchaser, that each of its products will be free from defects in materials and workmanship for two years from the date of purchase.

This warranty does not apply to any products which have been repaired or altered by persons other than repair personnel authorized by Advantech, or which have been subject to misuse, abuse, accident or improper installation. Advantech assumes no liability under the terms of this warranty as a consequence of such events.

Because of Advantech's high quality-control standards and rigorous testing, most of our customers never need to use our repair service. If an Advantech product is defective, it will be repaired or replaced at no charge during the warranty period. For out-of-warranty repairs, you will be billed according to the cost of replacement materials, service time and freight. Please consult your dealer for more details.

If you think you have a defective product, follow these steps:

1. Collect all the information about the problem encountered. (For example, CPU speed, Advantech products used, other hardware and software used, etc.) Note anything abnormal and list any onscreen messages you get when the problem occurs.
2. Call your dealer and describe the problem. Please have your manual, product, and any helpful information readily available.
3. If your product is diagnosed as defective, obtain an RMA (return merchandise authorization) number from your dealer. This allows us to process your return more quickly.
4. Carefully pack the defective product, a fully-completed Repair and Replacement Order Card and a photocopy proof of purchase date (such as your sales receipt) in a shippable container. A product returned without proof of the purchase date is not eligible for warranty service.
5. Write the RMA number visibly on the outside of the package and ship it prepaid to your dealer.

Initial Inspection

When you open the carton, please make sure that the following materials have been shipped:

- ARK-6320-6M01E
Fanless Mini-ITX embedded computer system with Atom™ D510 1.66 GHz dual core solution
- Startup Manual
- Driver CD
- Warranty Card
- Accessory box with a package of screws (for fastening the slim-type optical disk drive, disk drive, ears, etc.), a pair of ears, cables for connecting HDD and slim ODD.

If any of these items are missing or damaged, contact your distributor or sales representative immediately. We have carefully inspected the product mechanically and electrically before shipment. It should be free of marks and scratches and in perfect working order upon receipt. As you unpack the product, check it for signs of shipping damage. (For example, damaged box, scratches, dents, etc.) If it is damaged or it fails to meet the specifications, notify our service department or your local sales representative immediately. Also notify the carrier. Retain the shipping carton and pack-

ing material for inspection by the carrier. After inspection, we will make arrangements to repair or replace the unit.

Safety Precautions

Warning! *Always completely disconnect the power cord from chassis whenever you work with the hardware. Do not make connections while the power is on. Sensitive electronic components can be damaged by sudden power surges. Only experienced electronics personnel should open the PC chassis.*



Caution! *Always ground yourself to remove any static charge before touching the motherboard. Modern electronic devices are very sensitive to electrostatic discharges. As a safety precaution, use a grounding wrist strap at all times. Place all electronic components on a static-dissipative surface or in a static-shielded bag when they are not in the chassis.*



Caution! *The computer is provided with a battery-powered real-time clock circuit. There is a danger of explosion if battery is incorrectly replaced. Replace only with same or equivalent type recommended by the manufacturer. Discard used batteries according to manufacturer's instructions.*



Caution! *There is a danger of a new battery exploding if it is incorrectly installed. Do not attempt to recharge, force open, or heat the battery. Replace the battery only with the same or equivalent type recommended by the manufacturer. Discard used batteries according to the manufacturer's instructions.*



Contents

Chapter 1	General Information	1
1.1	Introduction	2
1.2	Specifications	3
1.3	Environmental Specifications	3
	Table 1.1: Environment specifications	3
1.4	Dimension Diagram.....	4
	Figure 1.1 Dimension diagram.....	4
Chapter 2	System Setup	5
2.1	Removing the Chassis Base	6
	Figure 2.1 Removing the chassis base.....	6
	Figure 2.2 Removing the front panel	7
	Figure 2.3 Removing the rear panel	7
2.2	Installing the SODIMM	7
	Figure 2.4 Installing the SODIMM.....	7
2.3	Installing Hard Disk Drives/ CF Card	8
	Figure 2.5 Installing hard disk drives	8
	Figure 2.6 Installing CF card.....	8
Chapter 3	Motherboard Overview.....	9
3.1	Board layout.....	10
	Figure 3.1 Motherboard layout.....	10
3.2	Jumpers and Connectors	11
	Table 3.1: Jumpers.....	11
	Table 3.2: Connectors	11
3.3	Motherboard Diagram	12
	Figure 3.2 Motherboard Diagram.....	12
3.4	Jumper Settings	12
3.4.1	How to Set Jumpers.....	12
3.4.2	CMOS Clear (CMOS1)	13
	Table 3.3: CMOS1	13
3.4.3	COM2 RS 232/422/485 Mode Selector (JSETCOM2).....	13
	Table 3.4: COM2 RS 232/422/485 Mode Selector (JSETCOM2)	
	13
3.4.4	J1: LCD Power 3.3 V/5 V Selector.....	14
	Table 3.5: J1: LCD Power 3.3 V/5 V Selector	14
3.4.5	PSON1: ATX, AT Mode Selector	14
	Table 3.6: PSON1: ATX, AT Mode Selector.....	14
3.4.6	JWDT1: Watchdog Timer Output Option	14
	Table 3.7: JWDT1: Watchdog Timer Output Options	14
3.5	I/O Connections	15
3.5.1	USB Ports (LAN1_USB12/LAN2_USB34/USB56/USB78)	15
	Table 3.8: LAN LED Indicator.....	15
3.5.2	VGA Connector (VGA1).....	16
3.5.3	Serial Ports (COM1~COM3)	17
3.5.4	PS/2 Keyboard and Mouse Connector (KBMS1).....	18
3.5.5	CPU Fan Connector (CPU_FAN1)	18
3.5.6	System FAN Connector (SYSFAN1)	19
3.5.7	Front Panel Connectors (JFP1/JFP1+JFP2)	19
	Table 3.9: ATX power supply LED status (No support for AT power)	
	er)	20

	3.5.8	Line Out, Mic In Connector (AUDIO1)	21
	3.5.9	Serial ATA Interface (SATA1, SATA2)	21
	3.5.10	Front Headphone Connector (HD1).....	22
	3.5.11	ATX 12V Power Connector (ATX12V).....	23
	3.5.12	SPI Flash connector(SPI_CN1)	23
Chapter	4	Operation	25
	4.1	The System Front Panel	26
	4.1.1	Power Button	26
	4.1.2	LED Indicators for System Status.....	26
		Table 4.1: Definition of LED indicators	26
	4.1.3	IO Placement.....	27
		Figure 4.1 Front panel	27
		Figure 4.2 Rear panel.....	27
Chapter	5	BIOS Operation	29
	5.1	Introduction	30
	5.2	BIOS Setup	30
	5.2.1	Main Menu	31
	5.2.2	Advanced BIOS Features	32
	5.2.3	CPU Configuration.....	33
	5.2.4	IDE Configuration	34
	5.2.5	Hardware Health Configuration	36
	5.2.6	ACPI Setting	37
	5.2.7	General ACPI Configuration	37
	5.2.8	Advanced ACPI Configuration	38
	5.2.9	Chipset ACPI Configuration.....	39
	5.2.10	APM Configuration.....	40
	5.2.11	USB Configuration	41
	5.2.12	USB Mass Storage Device Configuration.....	42
	5.2.13	Advanced PCI/PnP Settings	42
	5.2.14	Boot Settings	43
	5.2.15	Boot settings Configuration.....	44
	5.2.16	Security Setup	45
	5.2.17	Advanced Chipset Settings.....	45
	5.2.18	North Bridge Chipset Configuration	46
	5.2.19	Video Function Configuration	47
	5.2.20	South Bridge Chipset Configuration	48
	5.2.21	Exit Option	49
Chapter	6	Software Introduction & Service	51
	6.1	Introduction	52
	6.2	Value-Added Software Services	52
	6.2.1	Software API.....	52
	6.2.2	Software Utility.....	54
Chapter	7	Chipset Software Installation Utility	55
	7.1	Before You Begin.....	56
	7.2	Introduction	56
	7.3	Windows XP Driver Setup.....	57
Chapter	8	VGA Setup	59

8.1	Introduction	60
8.2	Windows 7/Vista/XP	60

Chapter 9 LAN Configuration.....61

9.1	Introduction	62
9.2	Features	62
9.3	Installation	62
9.4	Windows 7/Vista/XP Driver Setup (Intel 82567v/82583v)	63

Appendix A Exploded Diagram65

A.1	Exploded Diagram.....	66
	Figure A.1 Exploded diagram.....	66

Appendix B Programming the Watchdog Timer..67

B.1	Programming the Watchdog Timer	68
B.1.1	Watchdog Timer Overview.....	68
B.1.2	Programming the Watchdog Timer	68
	Table B.1: Watchdog Timer Registers	70
B.1.3	Example Program	71

Appendix C I/O Pin Assignments.....75

C.1	USB Header (USB56, USB78).....	76
	Table C.1: USB Header (USB56).....	76
C.2	VGA Connector (VGA1)	76
	Table C.2: VGA Connector (VGA1)	76
C.3	RS-232 Interface	77
	Table C.3: RS-232 Interface (COM4~COM6)	77
C.4	RS-232/422/485 Setting Interface (JETCOM2).....	77
	Table C.4: RS-232/422/485 Setting Interface (JETCOM2)	77
C.5	SPI_CN1: SPI Fresh Card Pin Connector.....	78
	Table C.5: SPI_CN1:SPI Fresh Card Pin Connector	78
C.6	PS/2 Keyboard and Mouse Connector (KBMS1)	78
	Table C.6: PS/2 Keyboard and Mouse Connector (KBMS1)	78
C.7	CPU Fan Power Connector (CPU_FAN1)	78
	Table C.7: CPU Fan Power Connector (CPU_FAN1).....	78
C.8	System Fan Power Connector (CHA_FAN1)	79
	Table C.8: System Fan Power Connector (SYSFAN1/SYSFAN2)	
	79
C.9	Power LED & Keyboard Lock Connector (JFP1)	79
	Table C.9: Power LED & Keyboard Lock Connector (JFP1).....	79
C.10	Power switch/HDD LED/SMBus/Speaker (JFP1+JFP2)	80
	Table C.10:Power Switch/HDD LED/SMBus/Speaker	
	(JFP1+JFP2)	80
C.11	USB/LAN ports (LAN1_USB12/LAN2_USB34).....	80
	Table C.11:USB Port	80
	Table C.12:Ethernet 10/100 Mbps RJ-45 Port.....	80
C.12	Line Out, Mic In Connector (AUDIO1).....	81
C.13	Serial ATA0/1 (SATA1/SATA2).....	81
	Table C.13:Serial ATA 0/1 (SATA1/SATA2)	81
C.14	AT/ATX Mode (PSON1)	81
	Table C.14:AT/ATX Mode (PSON1)	81
C.15	HD Audio Interface (HD1)	81
	Table C.15:AC-97 Audio Interface (HD1)	81

C.16	DMA Channel Assignments	82
	Table C.16:DMA Channel Assignments	82
C.17	Interrupt Assignments	82
	Table C.17:Interrupt Assignments	82
C.18	1st MB Memory Map	82
	Table C.18:1st MB Memory Map	82

Chapter 1

General Information

1.1 Introduction

The ARK-6320 industrial computer is a fanless wall-mountable/desktop computer that is ideal for system integrators who require a compact and rugged computing platform for embedded applications. With fanless operation, the ARK-6320 is dust-proof and noiseless, and offers the best MTBF performance.

Latest low power fanless solution of Computing Platform Options

The fanless ARK-6320 provides a full range of Atom™ dual core computing platforms for user selection: from the cutting edge ARK-6320-6M01E with Atom™ D510 processor as mainstream. Other computing platforms will be released in time and will share most of the ARK-6320 mechanical components. This modularized design concept will allow ARK-6320-based systems to be upgraded without modifying or changing supporting equipment.

Outstanding Industrial and Mechanical Design

Unlike regular industrial computers, ARK-6320 has an innovative appearance for an industrial computer system. It can be placed on the desk or mounted bi-directionally by the supplied brackets. It can be easily placed or fix-mounted onto most surfaces, such as walls or workbenches. The shockproof disk drive housing design protects the system against harsh industrial environments or unexpected shock. The front access I/O interface makes it easy to operate and maintain while installed in a ticketing machine, medical equipment, or other apparatus where access is limited. The extra LVDS is convenient for various applications. All these outstanding features make ARK-6320 the best solution on price, performance, and total cost of ownership.

1.2 Specifications

- **Chassis:** Heavy-duty steel
- **System Switch:** Power On/Off switch
- **System Indicators:**
 - HDD Activity: Single-color blue LED, blinking when reading/writing data
 - Temperature: Dual-color blue/red LED, turning blue into red when over-heat
- **Cooling System:** Dedicated heatspreader
- **Storage Capability:**
 - Compact Flash x 1 (on the solder side of the motherboard)
 - 2.5" HDD x 1
- **Input Voltage:** DC 12 V
- **Power Supply (Adapter):** Output +12 V @ 5 A (Max)
- **Physical Characteristics:**
 - Dimensions (W x H x D): 200 x 73 x 200 mm (7.9" x 2.9" x 7.9")
 - Net Weight: 4.14 kg (8.8 lb)

1.3 Environmental Specifications

Table 1.1: Environment specifications

Environment	Operating	Non-operating
Temperature	0 ~ 50°C (32 ~ 122°F)	-20 ~ 60°C (-4 ~ 140°F)
Humidity	10 ~ 85% @ 50°C, non-condensing	10 ~ 95% @ 50°C, non-condensing
Vibration	1G rms	2 G
Safety	CE/FCC UL, CB, CCC compliant	

1.4 Dimension Diagram

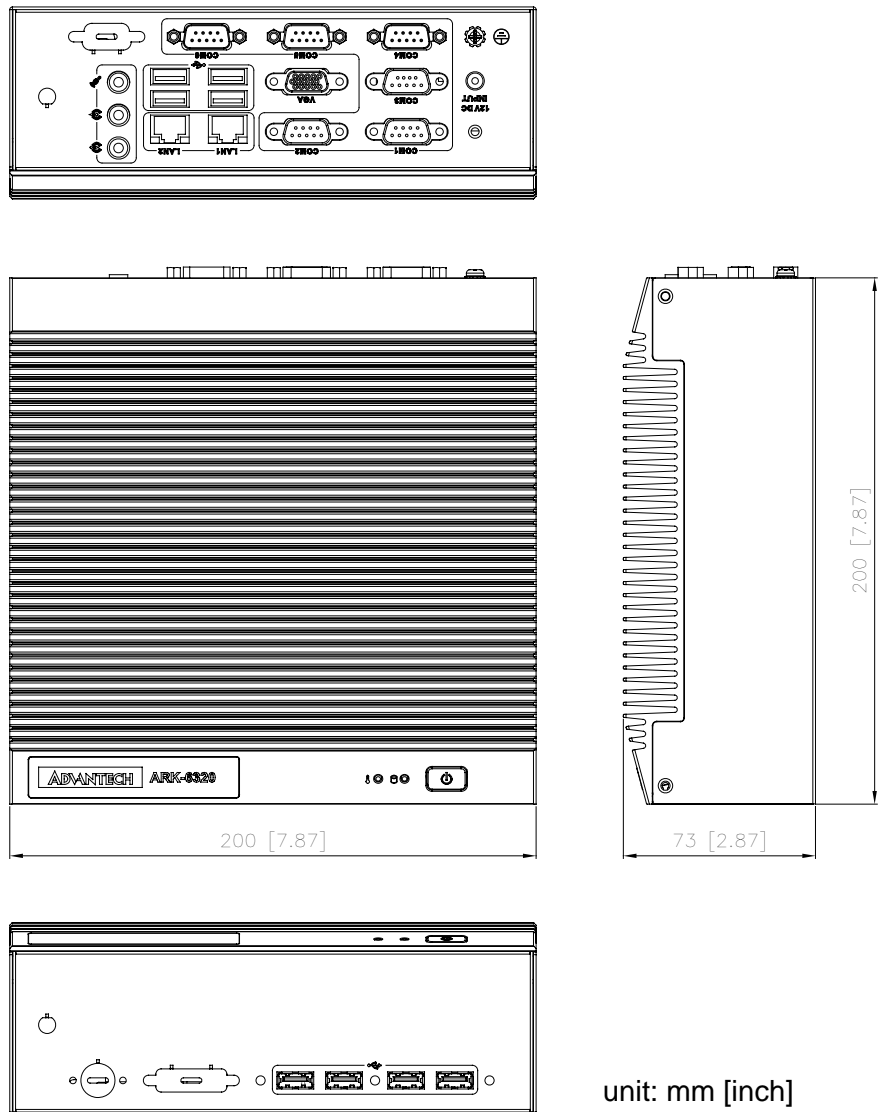

Figure 1.1 Dimension diagram

Chapter 2

System Setup

Note! Use caution when installing or operating the components with the chassis open. Be sure to turn off the power, unplug the power cord and ground yourself by touching the metal chassis before you handle any components inside the machine.



2.1 Removing the Chassis Base

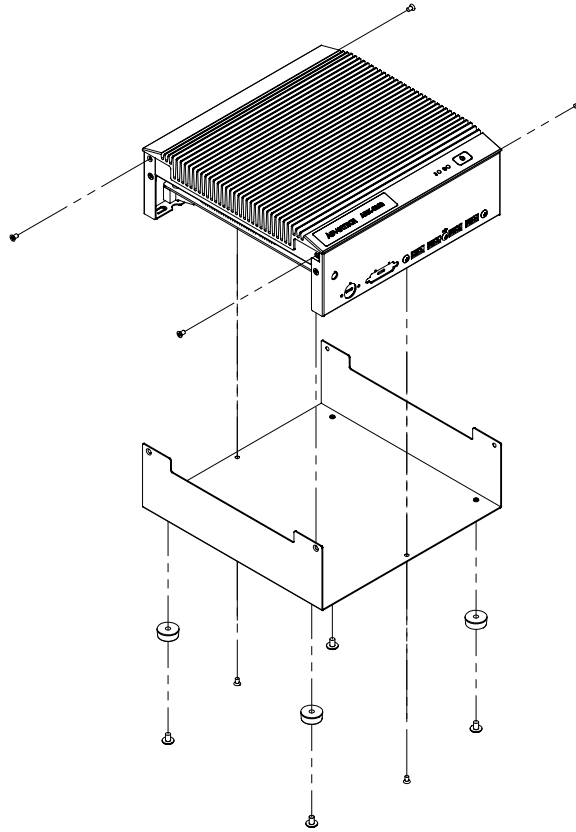

Figure 2.1 Removing the chassis base

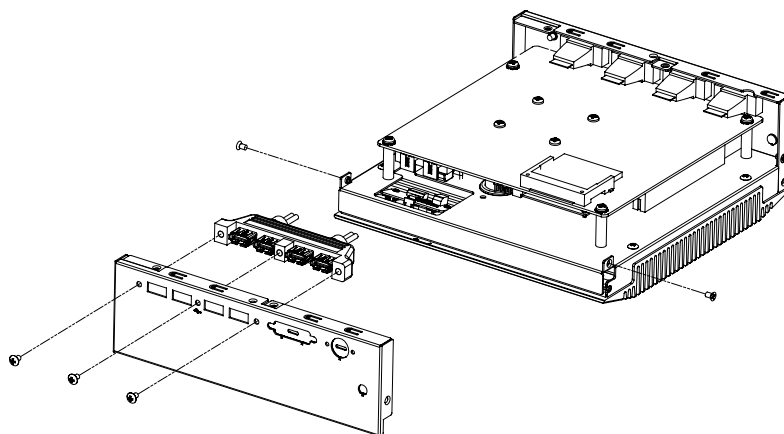

Figure 2.2 Removing the front panel

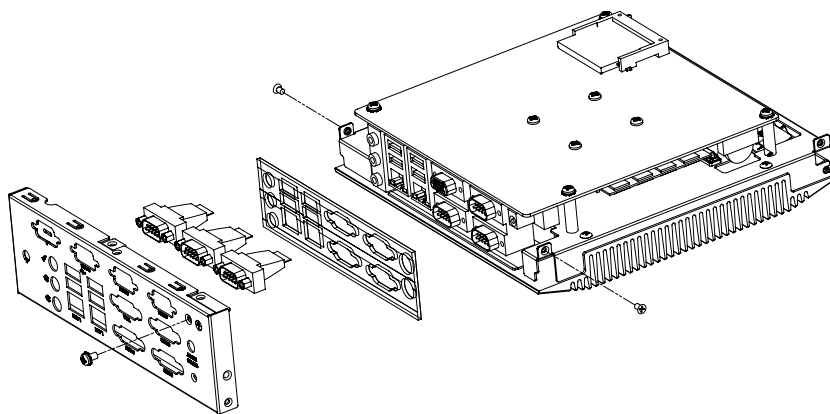

Figure 2.3 Removing the rear panel

2.2 Installing the SODIMM

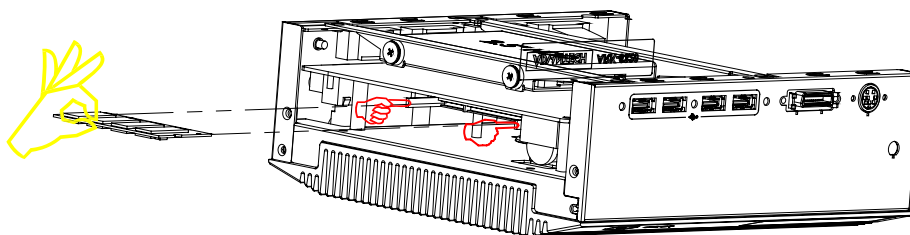

Figure 2.4 Installing the SODIMM

2.3 Installing Hard Disk Drives/ CF Card

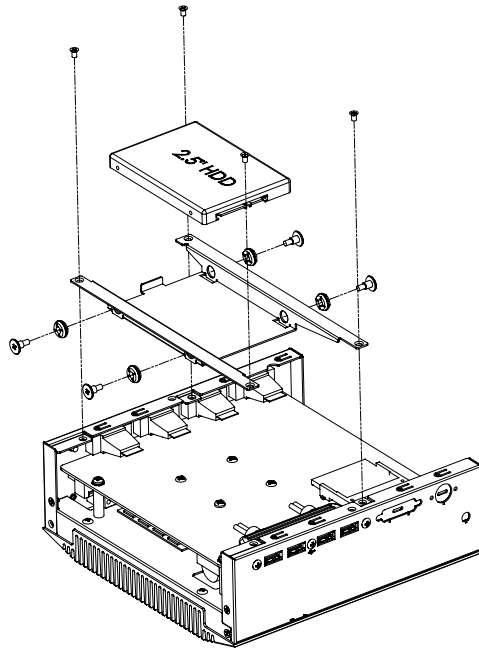

Figure 2.5 Installing hard disk drives

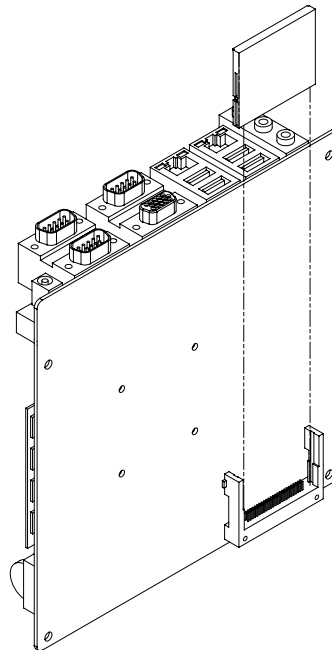

Figure 2.6 Installing CF card

Chapter 3

Motherboard Overview

3.1 Board layout

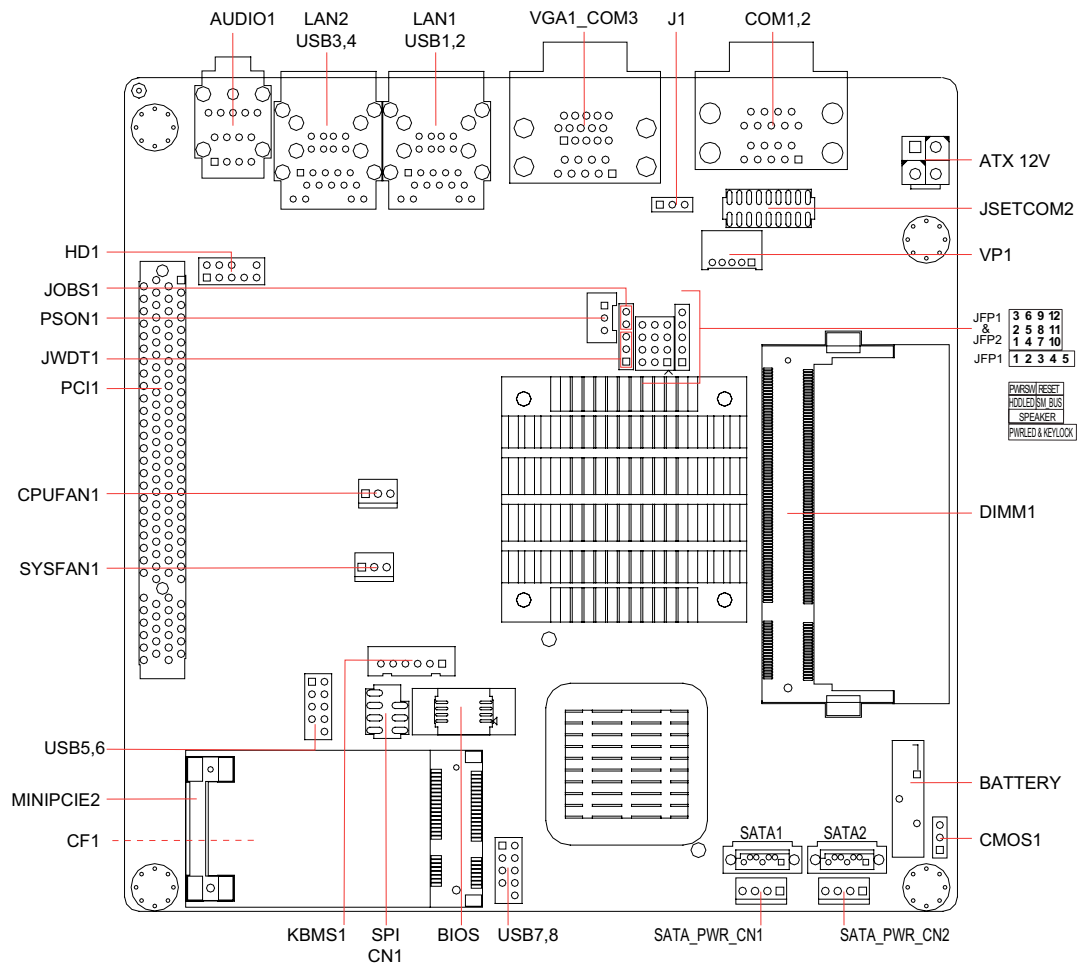

Figure 3.1 Motherboard layout

3.2 Jumpers and Connectors

Connectors on the motherboard link it to devices such as hard disk drives and a keyboard. In addition, the board has a number of jumpers used to configure your system for your application.

The tables below list the function of each jumper and connector. Later sections in this chapter give instructions on setting jumpers.

Table 3.1: Jumpers

Label	Function
JFP1	Power LED and Keyboard lock
JFP1+JFP2	Power switch/HDD LED/SMBus/Speaker
CMOS1	CMOS clear (Default 1-2)
J1	LVDS1 LCD power 3.3V/5V selection, Default (1-2, 3.3 V)
PSON1	AT(1-2) / ATX(2-3), (Default 2-3)
JSETCOM2	COM2 RS232/422/485 Jumper Setting
JWDT1	Watchdog Reset
JOBS1	OBS Alarm

Table 3.2: Connectors

Label	Function
USB5,6	USB port 5, 6 (on board)
USB7,8	USB port 7, 8 (on board)
VGA1	VGA connector
COM1,COM2	Serial port: COM1 (RS232) and COM2 (RS232, RS422 and RS485)
COM3	Serial port: COM3 (RS232)
KBMS1	Internal PS/2 Keyboard and Mouse connector
CPUFAN1	CPU FAN connector(3-pin)
SYSFAN1	System FAN connector(3-pin)
LAN1, USB1,2	LAN1 / USB port 1, 2
LAN2, USB3,4	LAN2 / USB port 3, 4
AUDIO1	Audio connector
HD1	HD Audio Front Panel Pin Header
SATA1	Serial ATA data connector 1
SATA_PWR_CN2	Serial ATA power connector 2
DIMMA1	Memory connector channel.
SPI_CN1	SPI flash update connector.
MINIPCIE2	Mini PCI express connector
ATX12V	ATX 12 V connector

3.3 Motherboard Diagram

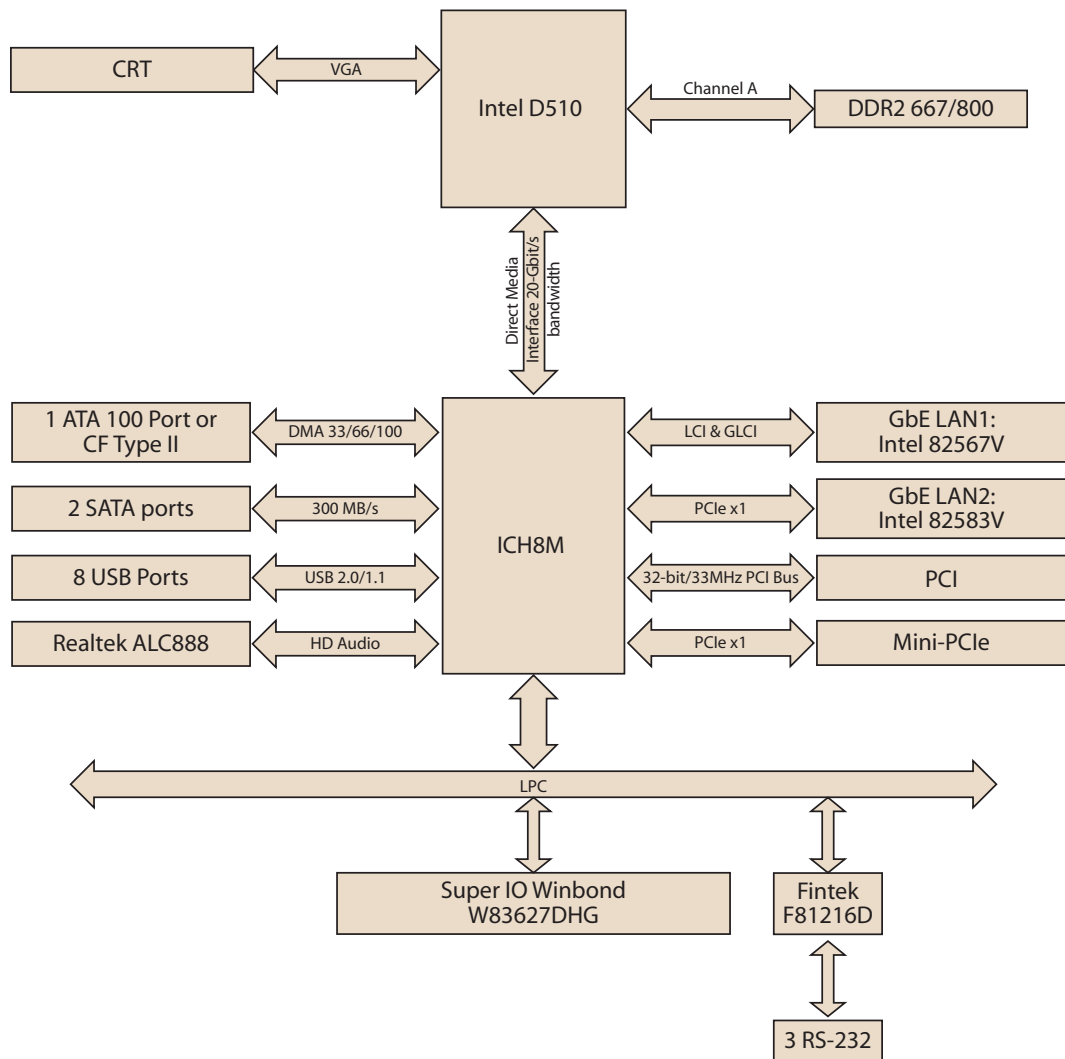

Figure 3.2 Motherboard Diagram

3.4 Jumper Settings

This section provides instructions on how to configure the motherboard by setting the jumpers. It also includes the motherboard's default settings and your options for each jumper.



3.4.1 How to Set Jumpers

You can configure motherboard to match the needs of your application by setting the jumpers. A jumper is a metal bridge that closes an electrical circuit. It consists of two metal pins and a small metal clip (often protected by a plastic cover) that slides over the pins to connect them. To “close” (or turn ON) a jumper, you connect the pins with the clip. To “open” (or turn OFF) a jumper, you remove the clip. Sometimes a jumper consists of a set of three pins, labeled 1, 2, and 3. In this case you connect either pins 1 and 2, or 2 and 3. A pair of needle-nose pliers may be useful when setting jumpers.

3.4.2 CMOS Clear (CMOS1)

The motherboard contains a jumper that can erase CMOS data and reset the system BIOS information. Normally this jumper should be set with pins 1-2 closed. If you want to reset the CMOS data, set J1 to 2-3 closed for just a few seconds, and then move the jumper back to 1-2 closed. This procedure will reset the CMOS to its default setting.

Table 3.3: CMOS1

Function	Jumper Setting
Keep CMOS data (default)	 1-2 closed
Clear CMOS data	 2-3 closed

3.4.3 COM2 RS 232/422/485 Mode Selector (JSETCOM2)

Users can use JSETCOM2 to select among RS 232/422/485 modes for COM2. The default setting is RS 232.

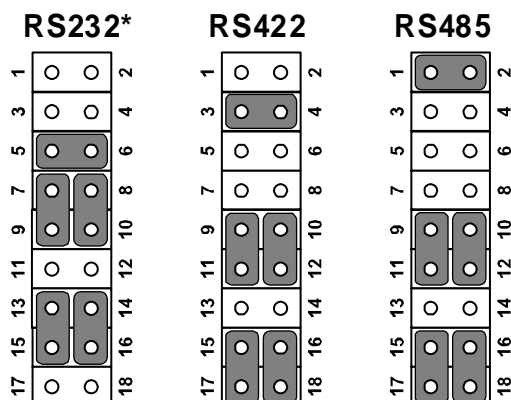

Table 3.4: COM2 RS 232/422/485 Mode Selector (JSETCOM2)

Function	Jumper Setting
RS232 (default)	(5-6) + (7-9) + (8-10) + (13-15) + (14-16) closed
RS422	(3-4) + (9-11) + (10-12) + (15-17) + (16-18) closed
RS-485	(1-2) + (9-11) + (10-12) + (15-17) + (16-18) closed

3.4.4 J1: LCD Power 3.3 V/5 V Selector

Table 3.5: J1: LCD Power 3.3 V/5 V Selector

Closed Pins	Result
1-2 (default)	3.3 V
2-3	5 V

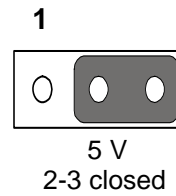
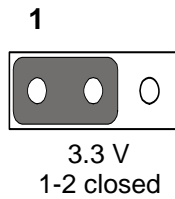

3.4.5 PS0N1: ATX, AT Mode Selector

Table 3.6: PS0N1: ATX, AT Mode Selector

Closed Pins	Result
1-2 (default)	AT Mode
2-3	ATX Mode

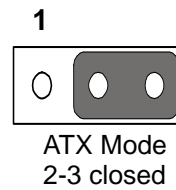
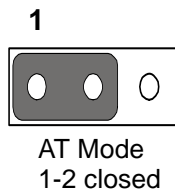

3.4.6 JWDT1: Watchdog Timer Output Option

Table 3.7: JWDT1: Watchdog Timer Output Options

Closed Pins	Result
1-2	NC
2-3 (default)	System Reset

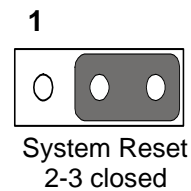
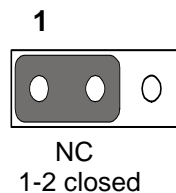

3.5 I/O Connections

3.5.1 USB Ports (LAN1_USB12/LAN2_USB34/USB56/USB78)

This motherboard provides up to eight USB ports. The USB interface complies with USB Specification Rev. 2.0 supporting transmission rate up to 480 Mbps and is fuse protected. The USB interface can be disabled in the system BIOS setup.

This motherboard is equipped with one high-performance 1000 Mbps Ethernet LAN adapter, and one 100 Mbps LAN adapter, both of which are supported by all major network operating systems. The RJ-45 jacks on the rear panel provide for convenient LAN connection.

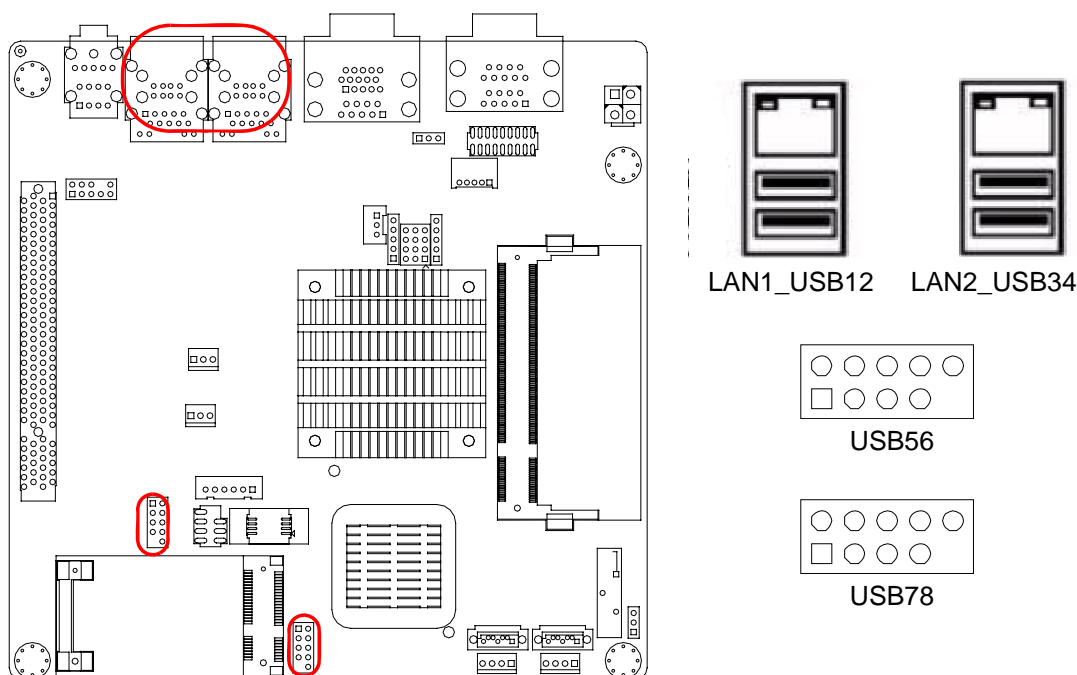
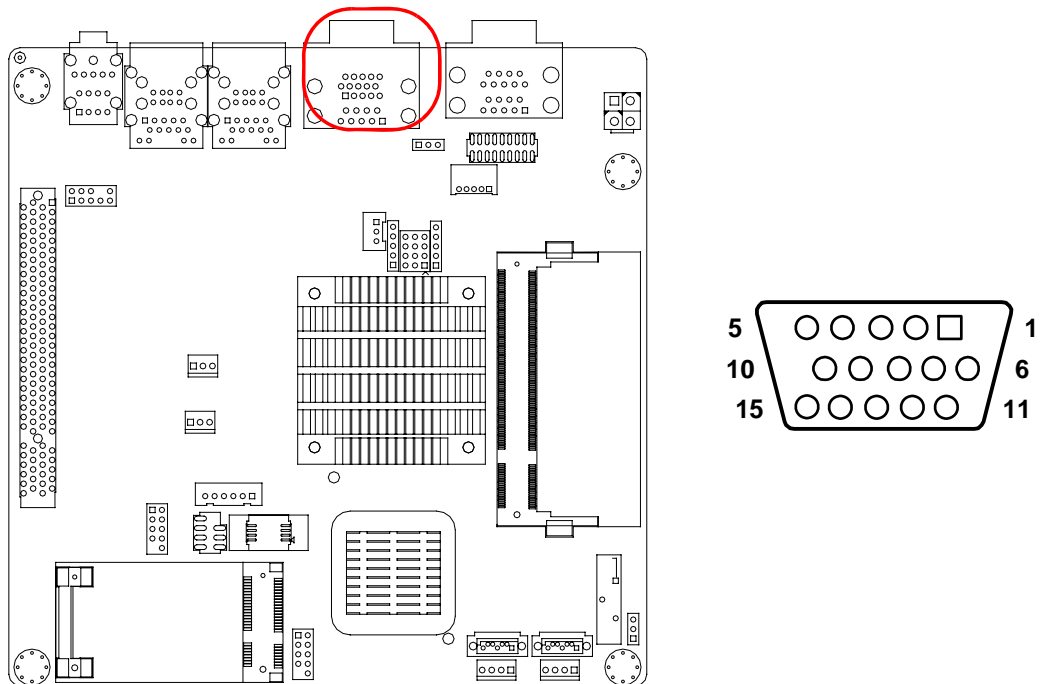

Table 3.8: LAN LED Indicator

LAN Mode	Lan Indicator
1 Gbps Link on	LED1 Green on
100 Mbps Link on	LED1 Orange on
Active	LED2 Green flash

3.5.2 VGA Connector (VGA1)



This motherboard includes a VGA interface that can drive conventional CRT displays. VGA1 is a standard 15-pin D-SUB connector commonly used for VGA. Pin assignments for CRT connector VGA1 are detailed in Appendix C.

3.5.3 Serial Ports (COM1~COM3)

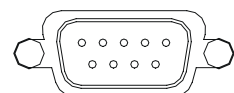
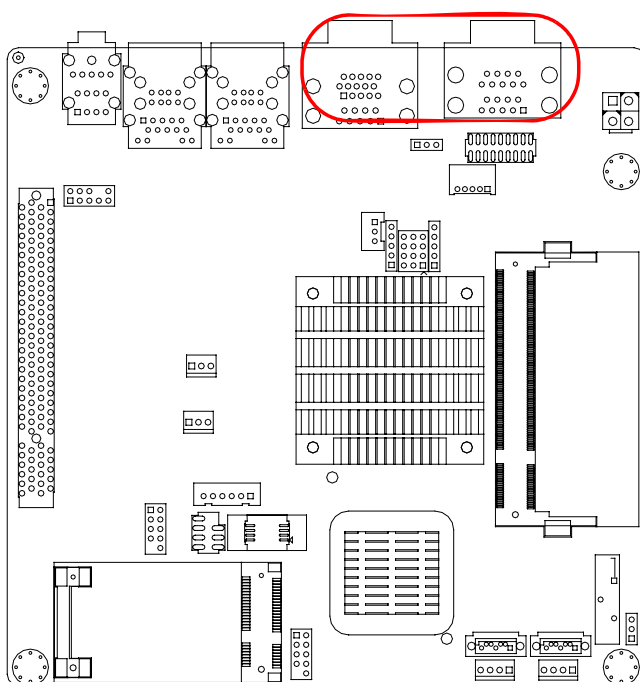

COM1/COM2/COM3

This motherboard supports three serial ports: COM1, COM2, and COM3. COM1 and COM3 operate in RS-232 mode. COM2 offers one of three modes: RS-232/422/485; the mode for COM2 can be set using JSETCOM2. These ports can connect to serial devices, such as a mouse or a printer, or to a communications network.

The IRQ and address ranges for both types of ports are fixed. However, if you want to disable the port or change these parameters later, you can do this in the system BIOS setup.

Different devices implement the RS-232/422/485 standards in different ways. If you should happen to have problems with a serial device, be sure to check the pin assignments for the connector.

3.5.4 PS/2 Keyboard and Mouse Connector (KBMS1)

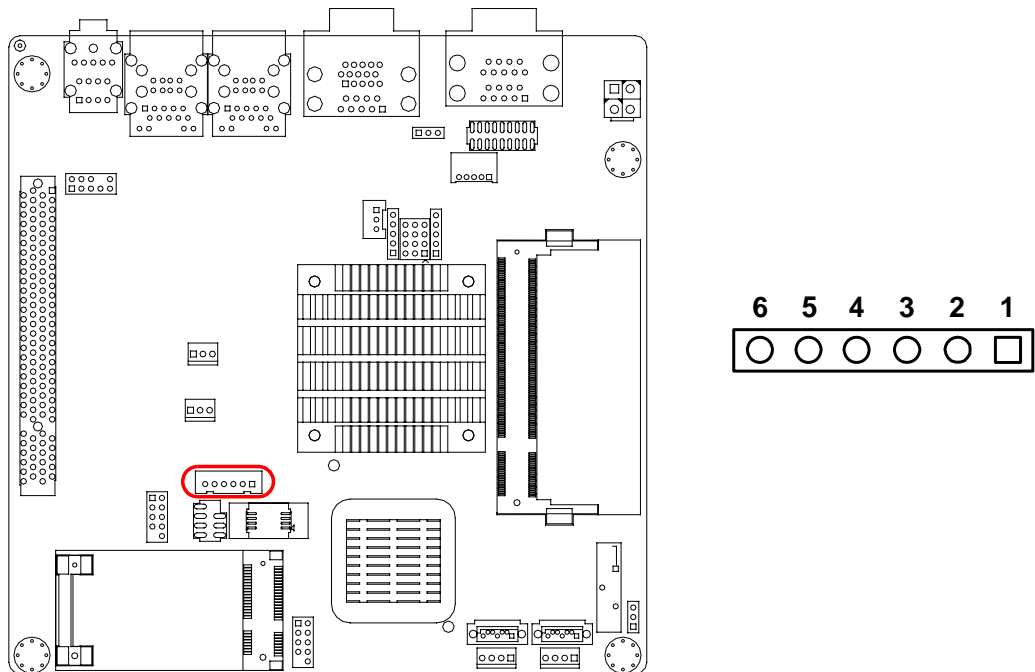

On board 6-pin wafer box connector, supports one standard PS/2 keyboard, one standard PS/2 mouse.

3.5.5 CPU Fan Connector (CPU_FAN1)

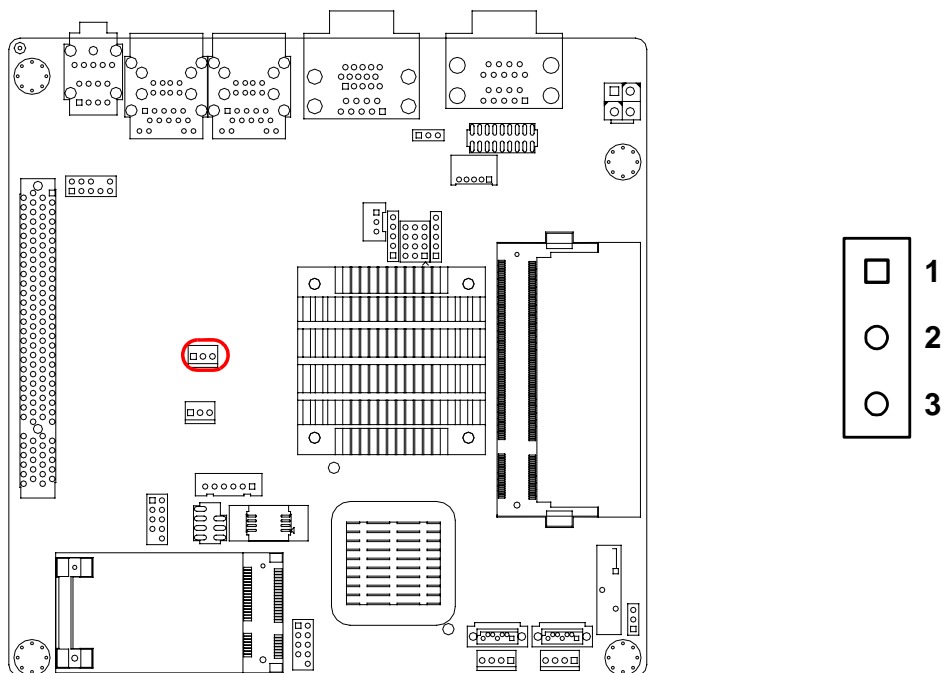

If a fan is used, this connector supports cooling fans of 500 mA (6 W) or less.

3.5.6 System FAN Connector (SYSFAN1)

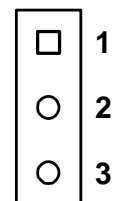
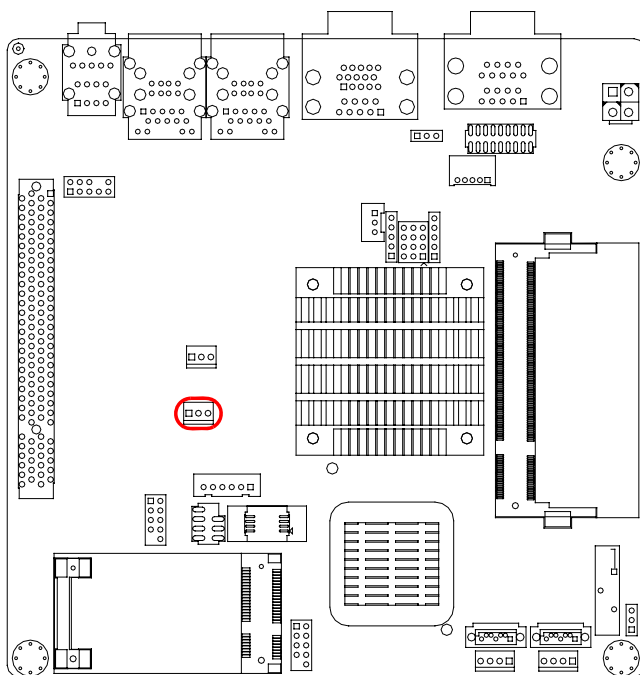

If a fan is used, this connector supports cooling fans of 500 mA (6 W) or less.

3.5.7 Front Panel Connectors (JFP1/JFP1+JFP2)

There are several external switches to monitor and control the IPC-100.

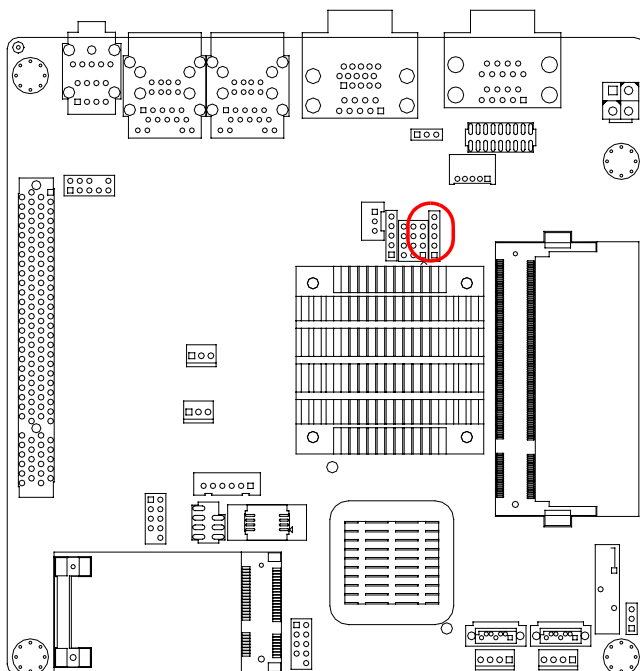

JFP1 & JFP2

3	6	9	12
2	5	8	11
1	4	7	10

JFP1

1	2	3	4	5
---	---	---	---	---

3.5.7.1 ATX soft power switch ((JFP1+JFP2/ PWR_SW))

If your computer case is equipped with an ATX power supply, you should connect the power on/off button on your computer case to (JFP1+JFP2/ PWR_SW), for convenient power on and off.

3.5.7.2 Reset (JFP1+JFP2/ RESET)

Many computer cases offer the convenience of a reset button. Connect the wire for the reset button.

3.5.7.3 HDD LED (JFP1+JFP2/ HDDLED)

You can connect an LED to connector (JFP2/HDDLED) to indicate when the HDD is active.

3.5.7.4 External speaker (JFP1+JFP2/ SPEAKER)

(JFP1+JFP2/ SPEAKER) is a 4-pin connector for an external speaker. If there is no external speaker, it provides an onboard buzzer as an alternative. To enable the buzzer, set pins 3-4 as closed.

3.5.7.5 Power LED and keyboard lock connector (JFP1 / PWR_LED & KEY LOCK)

(JFP1/PWR_LED & KEY LOCK) is a 5-pin connector for the power on LED and Key Lock function. Refer to Appendix B for detailed information on the pin assignments. The Power LED cable should be connected to pin 1-3. The key lock button cable should be connected to pin 4-5.

There are 3 modes for the power supply connection. The first is “ATX power mode”; the system turns on/off by a momentary power button. The second is “AT Power Mode”; the system turns on/off via the power supply switch. The third is another “AT Power Mode” which makes use of the front panel power switch. The power LED status is indicated in the following table:

Table 3.9: ATX power supply LED status (No support for AT power)

Power mode	LED (ATX Power Mode) (On/off by momentary button)	LED (AT power Mode) (On/off by switching power supply)	LED (AT power Mode) (On/off by front panel switch)
PSON1 (on back plane) jumper setting	pins 2-3 closed	pins 1-2 closed	Connect pins 1 & 2 to panel switch via cable
System On	On	On	On
System Suspend	Fast flashes	Fast flashes	Fast flashes
System Off	Slow flashes	Off	Off

3.5.8 Line Out, Mic In Connector (AUDIO1)

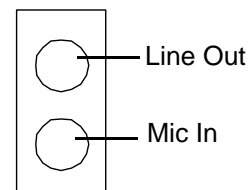
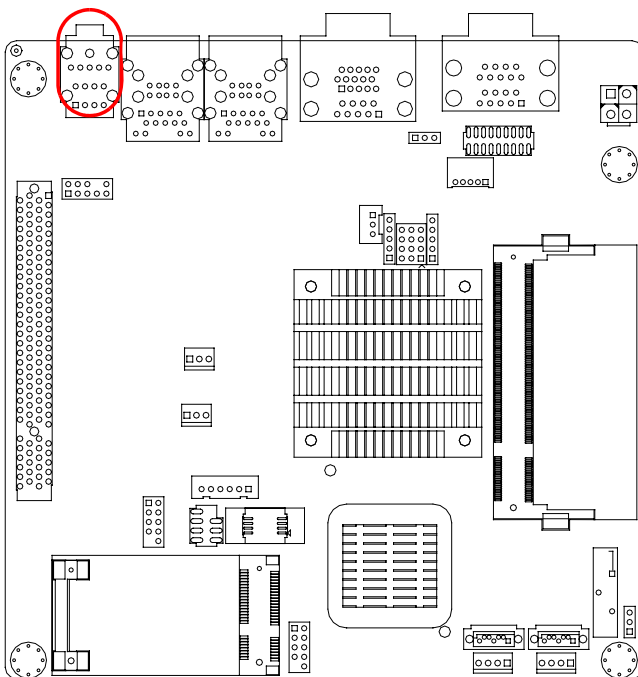

3.5.9 Serial ATA Interface (SATA1, SATA2)

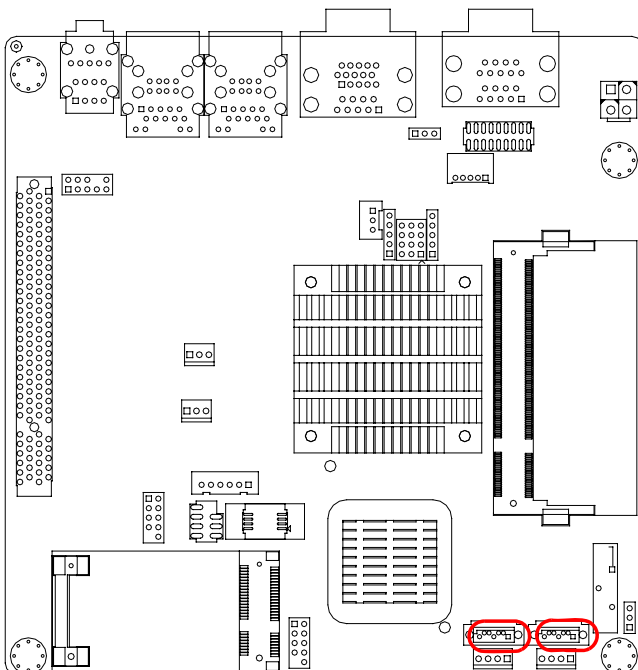

It features a high performance Serial ATA interface (up to 300 MB/s) which eases cabling to hard drives with long, thin cables.

3.5.10 Front Headphone Connector (HD1)

This connector is for a chassis-mounted front panel audio I/O module that supports either HD Audio or legacy AC'97 (optional) audio standard. Connect this connector with the front panel audio I/O module cable.

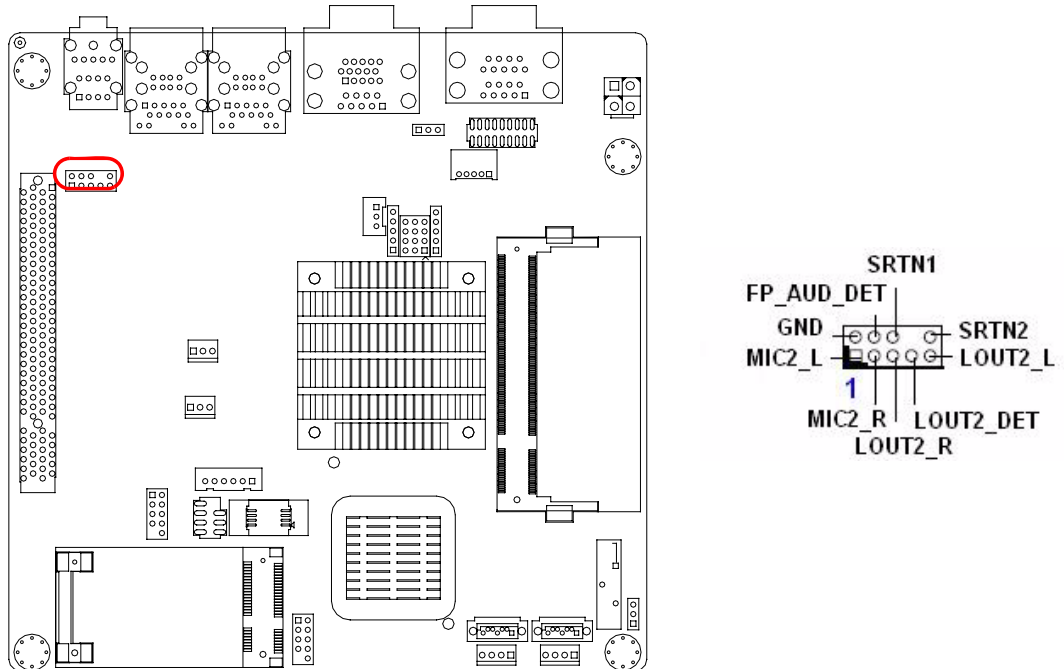

Note! *For motherboards with the optional HD Audio feature, we recommend that you connect a high-definition front panel audio module to this connector to take advantage of the motherboard's high definition audio capability.*



3.5.11 ATX 12V Power Connector (ATX12V)

This connector is for an ATX Micro-Fit power supply. The plugs from the power supply are designed to fit these connectors in only one direction. Determine the proper orientation and push down firmly until the connectors mate completely.

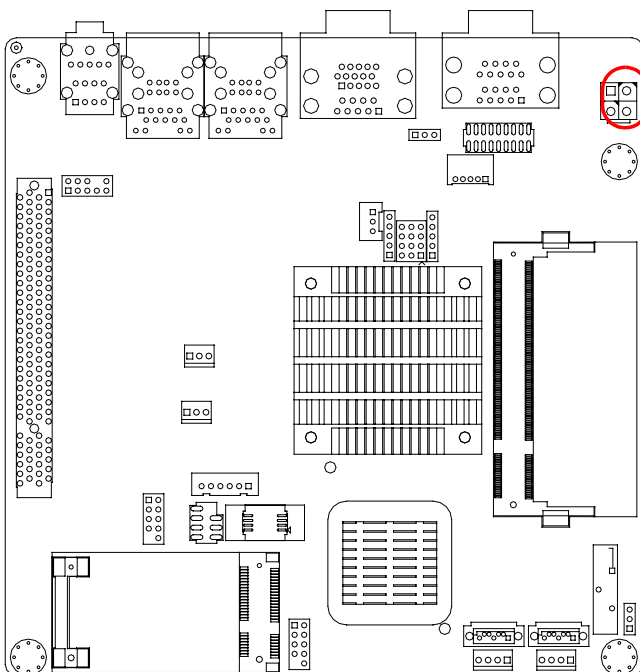

3.5.12 SPI Flash connector(SPI_CN1)

The SPI flash card pin header may be used to flash BIOS if the motherboard cannot power on.

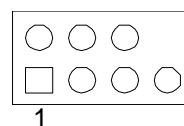
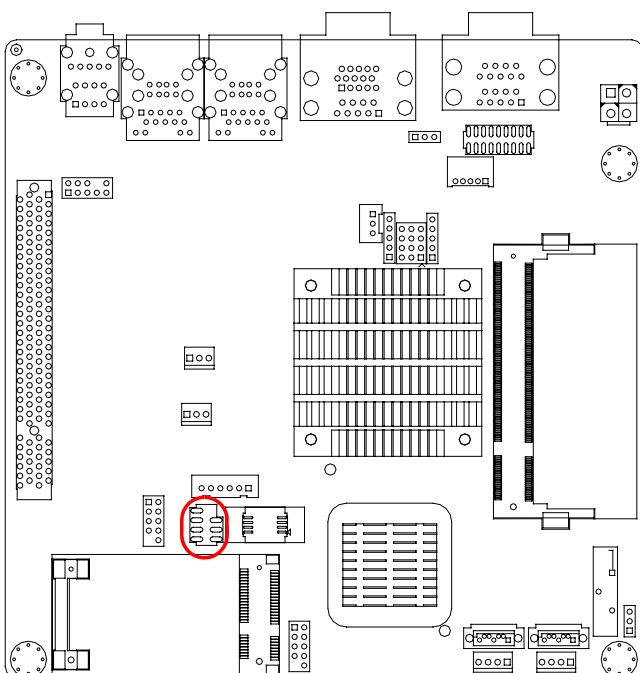

Chapter 4

Operation

4.1 The System Front Panel

On the front bezel, there is one Power On/Off switch and two LED indicators. Individual functions are described below



4.1.1 Power Button

Press this button to turn the system power on and off. Please use system shutdown or press this switch for few seconds to turn off the system power.

4.1.2 LED Indicators for System Status

- **Power LED:** Steady blue while the system power is on.
- **HDD LED:** Flashing blue while the HDD is accessing data.
- **Temp LED:** Steady blue while the internal temperature is under 50°C. If the internal temperature climbs above 60°C, this LED turns red; it stays red until internal temperature drops below 50°C.

Table 4.1: Definition of LED indicators

Icon	LED	Description	Blue	No light
	Power	Power	Normal	Off or failure
	HDD	Hard Disk	Reading	NO reading
	Temp	Over-heating	Normal	Over (Red)

Note! The temperature indicator LED is accurate to within $\pm 5^{\circ}\text{C}$.



4.1.3 IO Placement

Front Panel

- Power switch
- 4 USB
- Antenna
- Reserve IO for LVDS and inverter

Rear Panel

- Dual Giga LANs
- 4 USB
- Audio
- 6 COMs
- VGA
- DIO
- Antenna
- DC12 V input (drum type)



Figure 4.1 Front panel



Figure 4.2 Rear panel

Chapter 5

BIOS Operation

5.1 Introduction

AMI BIOS has been integrated into many motherboards, and has been very popular for over a decade. People sometimes refer to the AMI BIOS setup menu as BIOS, BIOS setup or CMOS setup.

With the AMI BIOS Setup program, you can modify BIOS settings and control the special features of your computer. The Setup program uses a number of menus for making changes and turning special features on or off. This chapter describes the basic navigation of the BIOS setup screens.

5.2 BIOS Setup

This motherboard has AMI BIOS built in, with a CMOS SETUP utility that allows users to configure required settings or to activate certain system features.

The CMOS SETUP saves the configuration in the CMOS RAM of the motherboard. When the power is turned off, the battery on the board supplies the necessary power to preserve the CMOS RAM.

When the power is turned on, press the button during the BIOS POST (Power-On Self Test) to access the CMOS SETUP screen.

Control Keys

< ↑ >< ↓ >< ← >< → >	Move to select item
----------------------	---------------------

<Enter>	Select Item
---------	-------------

<Esc>	Main Menu - Quit and not save changes into CMOS Sub Menu - Exit current page and return to Main Menu
-------	---

<Page Up/+>	Increase the numeric value or make changes
-------------	--

<Page Down/->	Decrease the numeric value or make changes
---------------	--

<F1>	General help, for Setup Sub Menu
------	----------------------------------

<F2>	Item Help
------	-----------

<F5>	Load Previous Values
------	----------------------

<F7>	Load Setup Defaults
------	---------------------

<F10>	Save all CMOS changes
-------	-----------------------

5.2.1 Main Menu

Press to enter AMI BIOS CMOS Setup Utility, the Main Menu will appear on the screen. Use arrow keys to select among the items and press <Enter> to accept or enter the sub-menu.

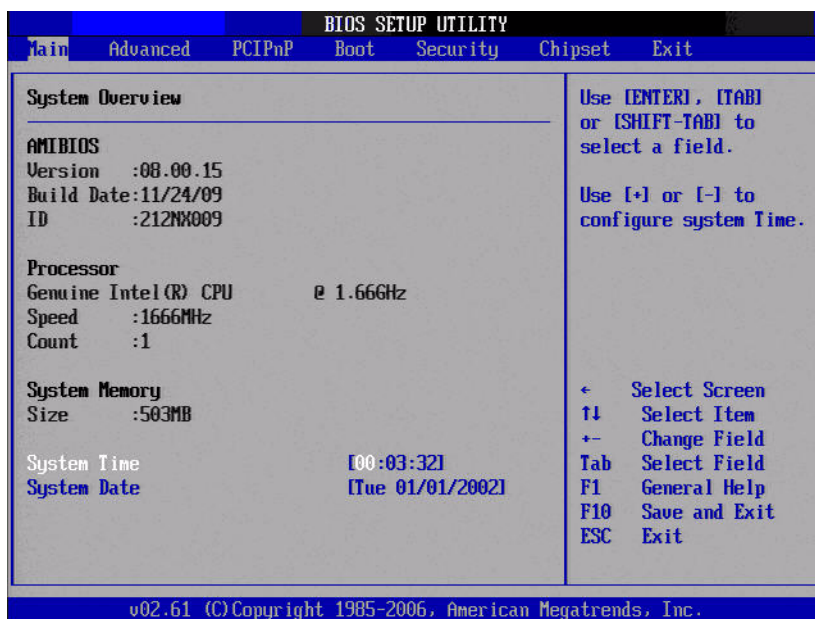

The Main BIOS setup screen has two main frames. The left frame displays all the options that can be configured. Grayed-out options cannot be configured; options in blue can. The right frame displays the key legend.

Above the key legend is an area reserved for a text message. When an option is selected in the left frame, it is highlighted in white. Often a text message will accompany it.

■ System time / System date

Use this option to change the system time and date. Highlight System Time or System Date using the <Arrow> keys. Enter new values through the keyboard. Press the <Tab> key or the <Arrow> keys to move between fields. The date must be entered in MM/DD/YY format. The time must be entered in HH:MM:SS format.

5.2.2 Advanced BIOS Features

Select the Advanced tab from the setup screen to enter the Advanced BIOS Setup screen. You can select any of the items in the left frame of the screen, such as CPU Configuration, to go to the sub menu for that item. You can display an Advanced BIOS Setup option by highlighting it using the <Arrow> keys. All Advanced BIOS Setup options are described in this section. The Advanced BIOS Setup screen is shown below. The sub menus are described on the following pages.



5.2.3 CPU Configuration

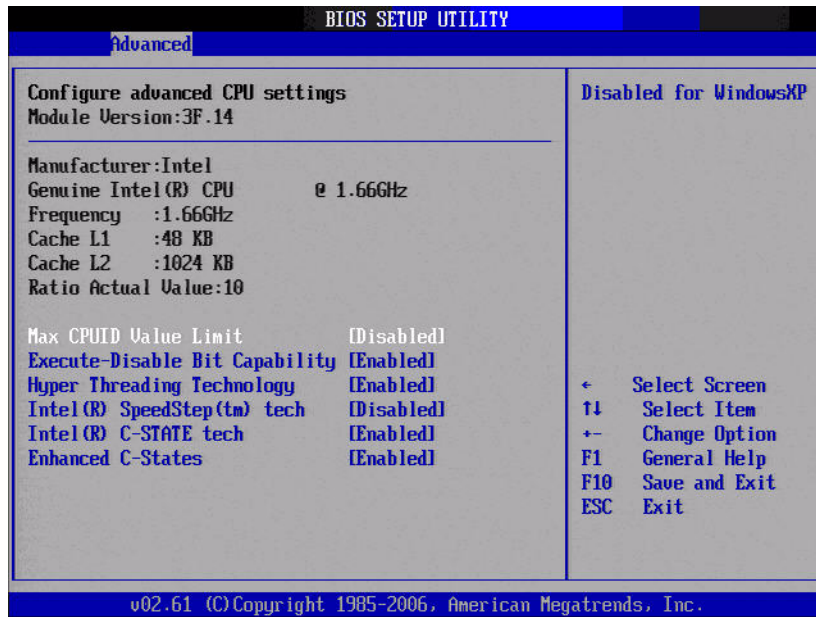

- **Max CPUID Value Limit**
This item allows you to limit CPUID maximum value.
- **Execute-Disable Bit Capability**
This item allows you to enable or disable the No-Execution page protection technology.
- **Hyper Threading Technology**
This item allows you to enable or disable Intel Hyper Threading technology.
- **Intel® SpeedStep™ tech**
When set to disabled, the CPU runs at its default speed, when set to enabled, the CPU speed is controlled by the operating system.
- **Intel® C-STATE tech**
This item allows the CPU to save more power under idle mode.
- **Enhanced C-States**
CPU idle set to enhanced C-States, disabled by Intel®. C-STATE tech item.

5.2.4 IDE Configuration

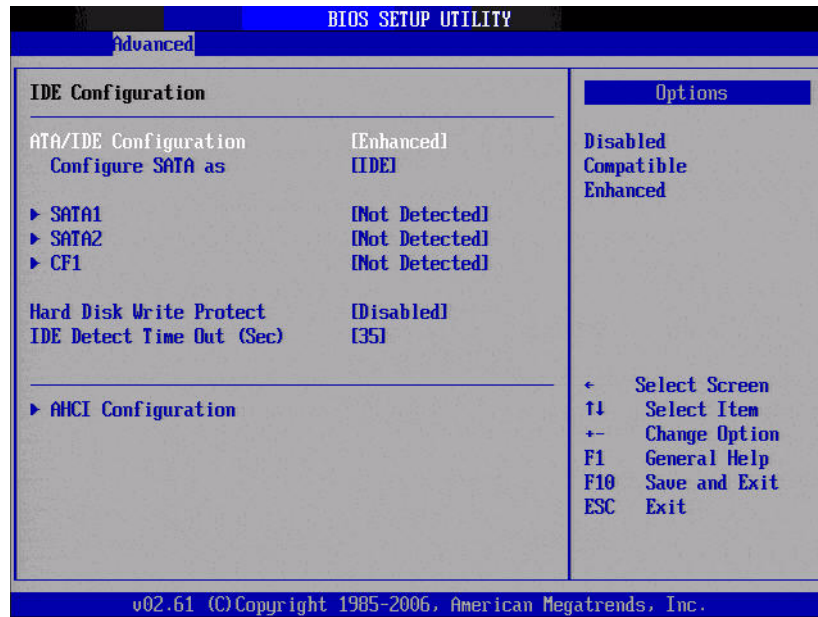

- **ATA/IDE Configuration**
This can be configured as Disabled, Compatible or Enhanced.
- **Configure SATA as**
This can be configured as IDE or AHCI.
- **SATA1/SATA2**
While entering setup, the BIOS automatically detects the presence of SATA devices. This displays the status of SATA device auto-detection.
- **CF1**
While entering setup, the BIOS automatically detects the presence of CF devices. This displays the status of CF device auto-detection.
- **Hard Disk Write Protect**
Disable/Enable device write protection. This will be effective only if device is accessed through BIOS.
- **IDE Detect Time Out (Sec)**
This item allows you to select the time out value for detecting ATA/ATAPI device(s).
- **AHCI Configuration**
AHCI is a new interface specification that allows the SATA controller driver to support advanced features. While entering setup, BIOS auto detects the presence of AHCI devices. This displays the status of auto detection of AHCI devices.
- **Super I/O Configuration**
This item enables users to set the Super IO device status, including enabling of COMs.

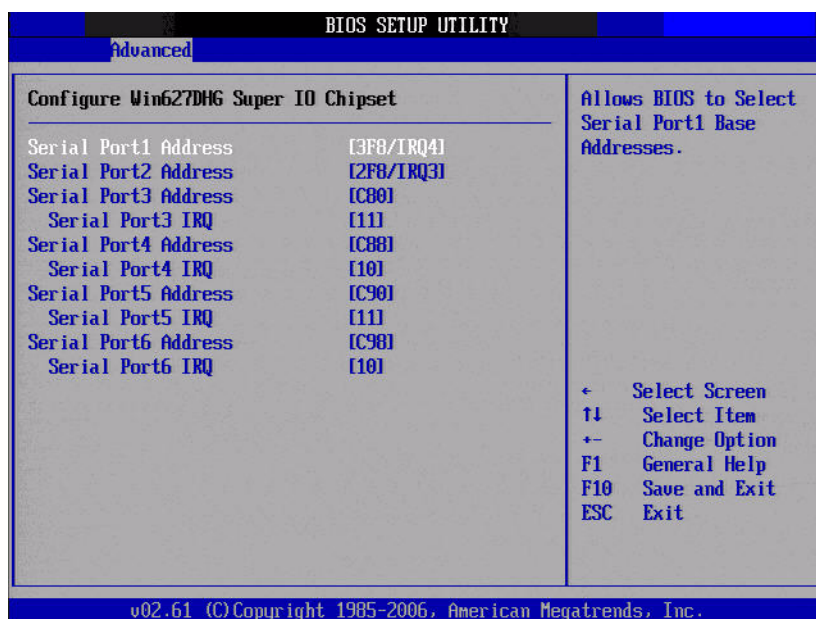

- **Onboard Serial port 1 [3F8 / IRQ4]**
This item allows user to adjust serial port 1 address and IRQ.
- **Onboard Serial port 2 [2F8/ IRQ3]**
This item allows user to adjust serial port 2 address and IRQ.
- **Onboard Serial port 3 [C80/IRQ11]**
This item allows user to adjust serial port 3 address and IRQ.
- **Onboard Serial port 4 [C88/IRQ10]**
This item allows user to adjust serial port 4 address and IRQ.
- **Onboard Serial port 5 [C90/IRQ11]**
This item allows user to adjust serial port 5 address and IRQ.
- **Onboard Serial port 6 [C98/IRQ10]**
This item allows user to adjust serial port 6 address and IRQ.

5.2.5 Hardware Health Configuration

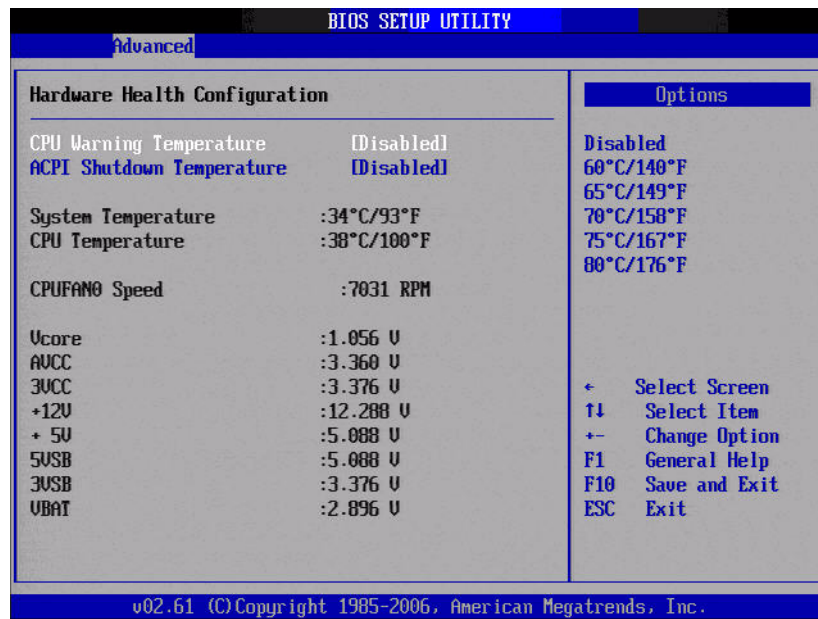

- **CPU warning temperature**
Use this to set the CPU warning temperature threshold. When the system CPU reaches the warning temperature, the buzzer will sound.
- **ACPI Shut Down Temperature**
This allows the user to set the CPU temperature at which the system will automatically shut down to prevent CPU overheat damage.

5.2.6 ACPI Setting

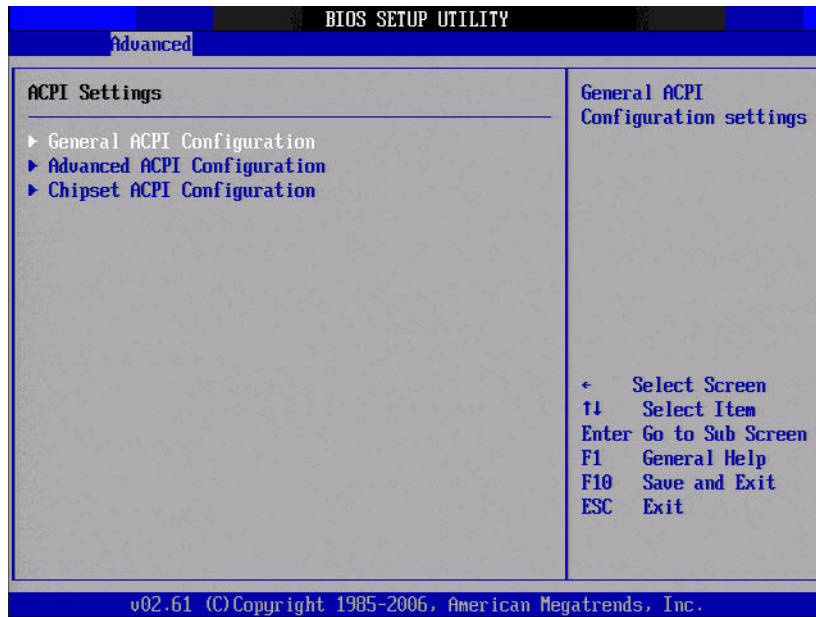

5.2.7 General ACPI Configuration

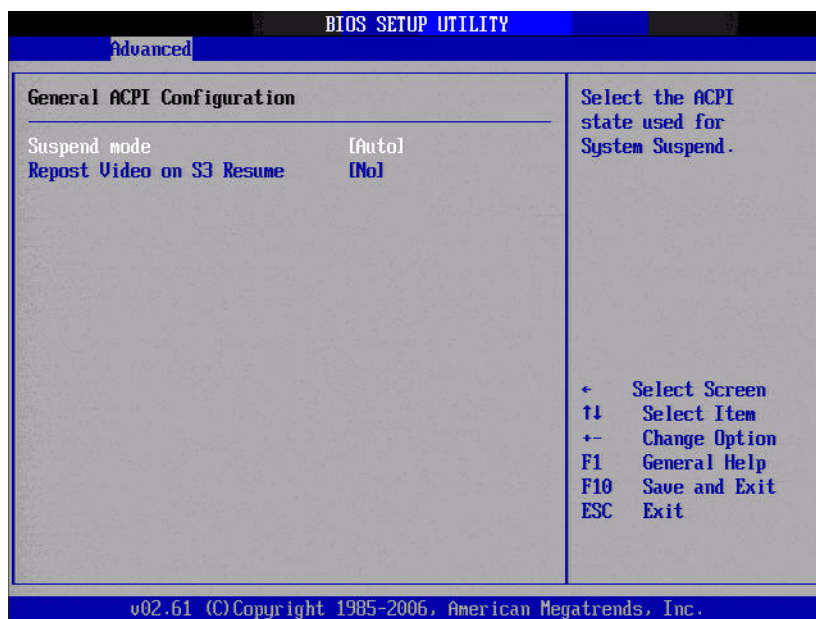

- **Suspend mode**
Select the ACPI state used for system suspend.
- **Report Video on S3 Resume**
This item allows you to invoke VA BIOS POST on S3/STR resume.

5.2.8 Advanced ACPI Configuration

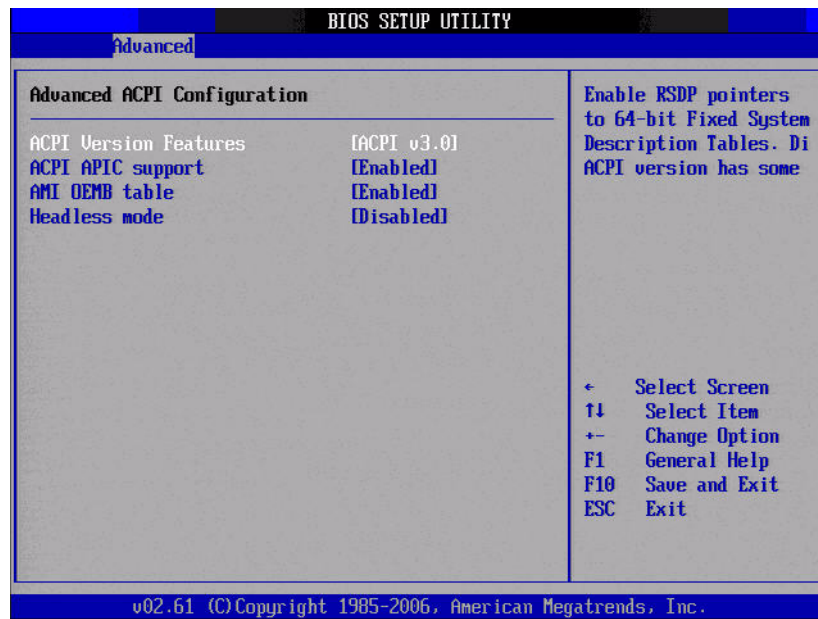

- **ACPI Version Features**
This item allows you to enable RSDP pointers to 64-bit fixed system description tables.
- **ACPI APIC support**
Include APIC table pointer to RSDT pointer list.
- **AMI OEMB table**
Include OEMB table pointer to R(x)SDT pointer lists.
- **Headless mode**
Enable / Disable Headless operation mode through ACPI.

5.2.9 Chipset ACPI Configuration

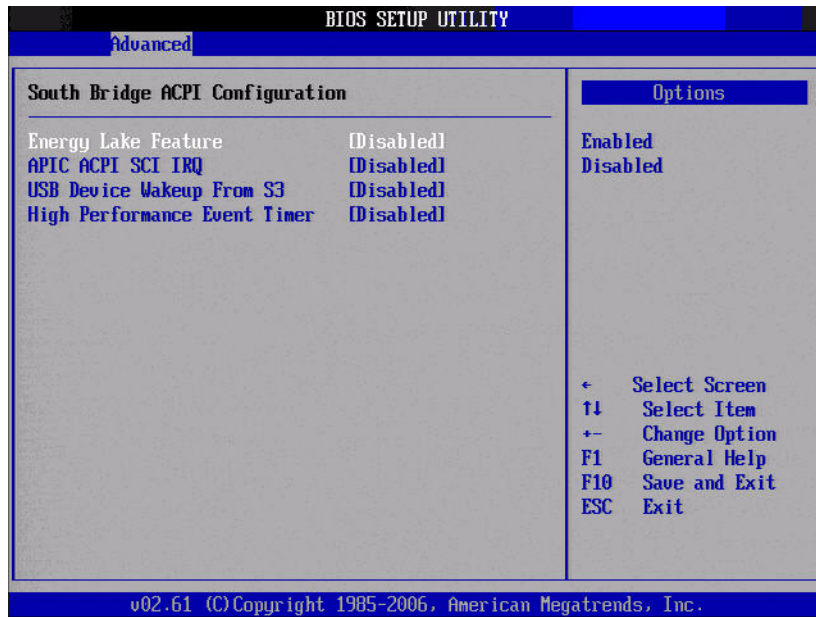

- **Energy Lake Feature**
Allows you to configure Intel's Energy Lake power management technology.
- **APIC ACPI SCI IRQ**
Enable/Disable APIC ACPI SCI IRQ.
- **USB Device Wakeup From S3/S4**
Enable/Disable USB Device Wakeup from S3/S4.
- **High Performance Event Timer**
Enable/Disable High performance Event timer.

5.2.10 APM Configuration

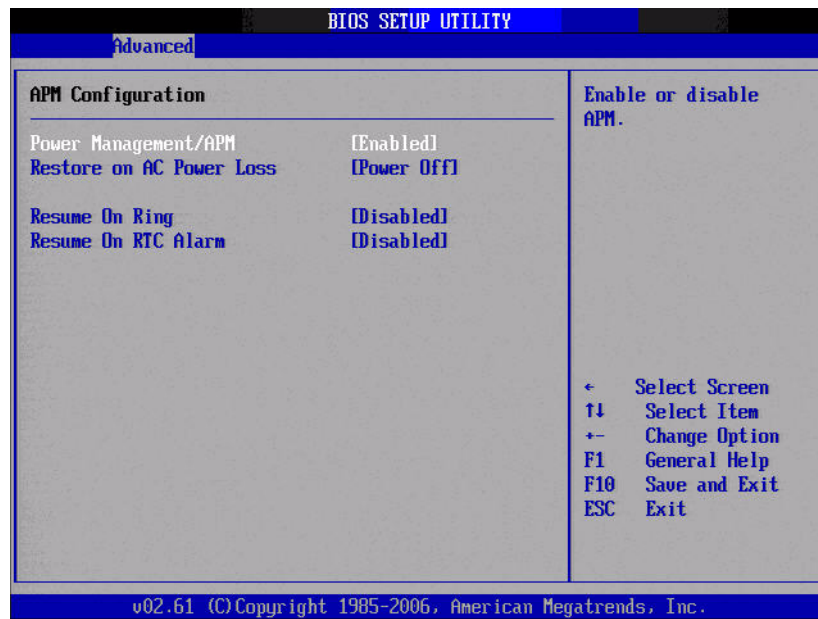

- **Power Management/APM**
Enable or disable APM power management function.
- **Restore on AC Power Loss**
This option allows user to set system action when AC power restores after AC power loss. Available options include Power Off, Power On, Last Status.
- **Resume On Ring**
Disable/Enable RI wake event.
- **Resume On RTC Alarm**
Disable/Enable RTC wake event.

5.2.11 USB Configuration

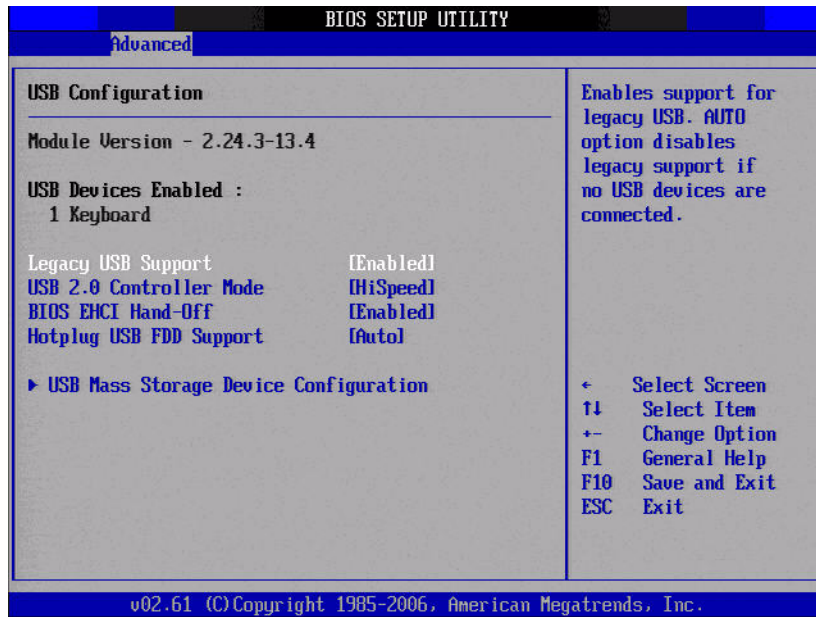

- **Legacy USB Support**
Enables support for legacy USB. Auto option disables legacy support if no USB devices are connected.
- **USB 2.0 Controller Mode**
This item allows you to select HiSpeed (480 Mbps) or FullSpeed (12 Mbps).
- **BIOS EHCI Hand-Off**
This is a workaround for OSs without EHCI hand-off support. The EHCI ownership change should be claimed by EHCI driver.
- **Hotplug USB FDD Support**
A dummy FDD device is created that will be associated with the hotplugged FDD later. Auto option creates this dummy device only if there is no USB FDD present.

5.2.12 USB Mass Storage Device Configuration

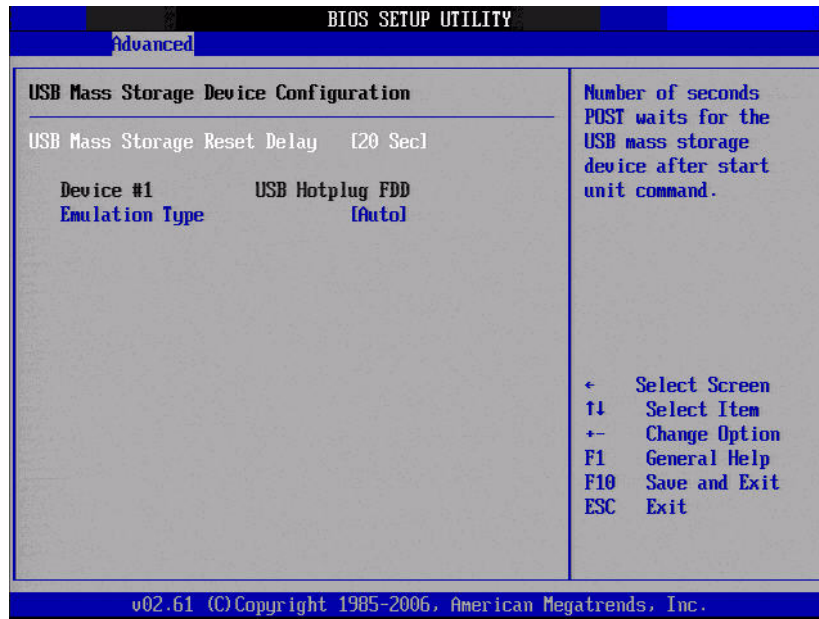

- **USB Mass Storage Reset Delay**

Number of seconds POST waits for the USB mass storage device after start unit command.

- **Emulation Type**

If Auto, USB devices less than 530MB will be emulated as floppy drives, and remaining as hard drives. Force FDD option can be used to force a FDD formatted drive to boot as FDD (e.g., a ZIP drive).

5.2.13 Advanced PCI/PnP Settings

Select the PCI/PnP tab from the setup screen to enter the Plug and Play BIOS Setup screen. You can display a Plug and Play BIOS Setup option by highlighting it using the <Arrow> keys. All Plug and Play BIOS Setup options are described in this section. The Plug and Play BIOS Setup screen is shown below.

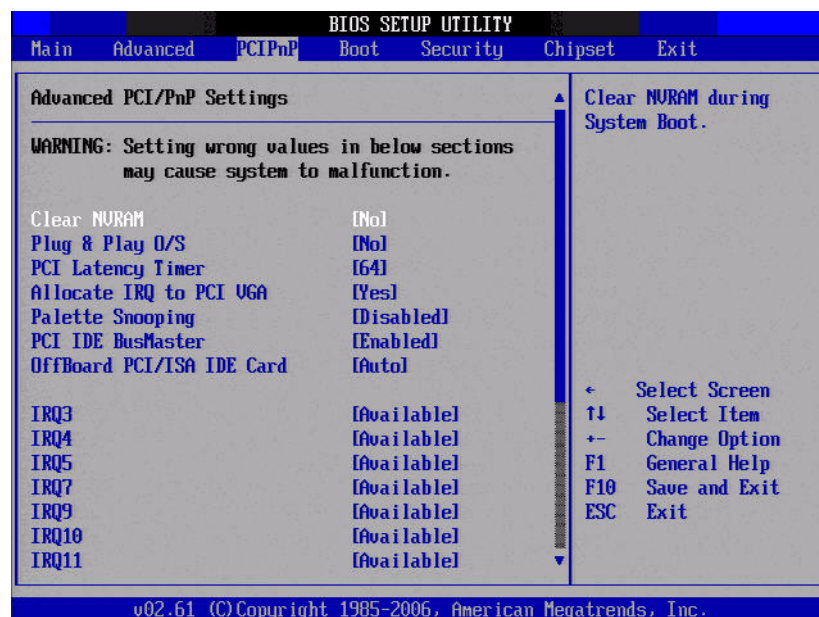

- **Clear NVRAM**
Set this value to force the BIOS to clear the Non-Volatile Random Access Memory (NVRAM).The Optimal and Fail-Safe default setting is No.
- **Plug & Play O/S**
When set to No, BIOS configures all the devices in the system. When set to Yes and if you install a Plug and Play operating system, the operating system configures the Plug and Play devices not required for bootup.
- **PCI Latency Timer**
Value in units of PCI clocks for PCI device latency timer register.
- **Allocate IRQ to PCI VGA**
When set to Yes, will assign IRQ to PCI VGA card if card requests IRQ. When set to No will not assign IRQ to PCI VGA card even if card requests an IRQ.
- **Palette Snooping**
This item is designed to solve problems caused by some non-standard VGA card.
- **PCI IDE BusMaster**
When set to enabled, BIOS uses PCI busmastering for reading/writing to IDE drives.
- **OffBoard PCI/ISA IDE Card**
Some PCI IDE cards may require this to be set to the PCI slot number that is holding the card. Set to Auto works for most PCI IDE cards.
- **IRQ3 / 4 / 5 / 7 / 9 / 10 / 11**
This item allows you respectively assign an interrupt types for IRQ-3, 4, 5, 7, 9, 10, 11.
- **DMA Channel0 / 1 / 3 / 5 / 6 / 7**
When set to Available, will specify DMA is available to be used by PCI/PnP devices. When set to Reserved, will specified DMA is Reserved for use by legacy ISA devices.
- **Reserved Memory Size**
This item allows you to reserve a set amount of memory for legacy ISA devices.

5.2.14 Boot Settings

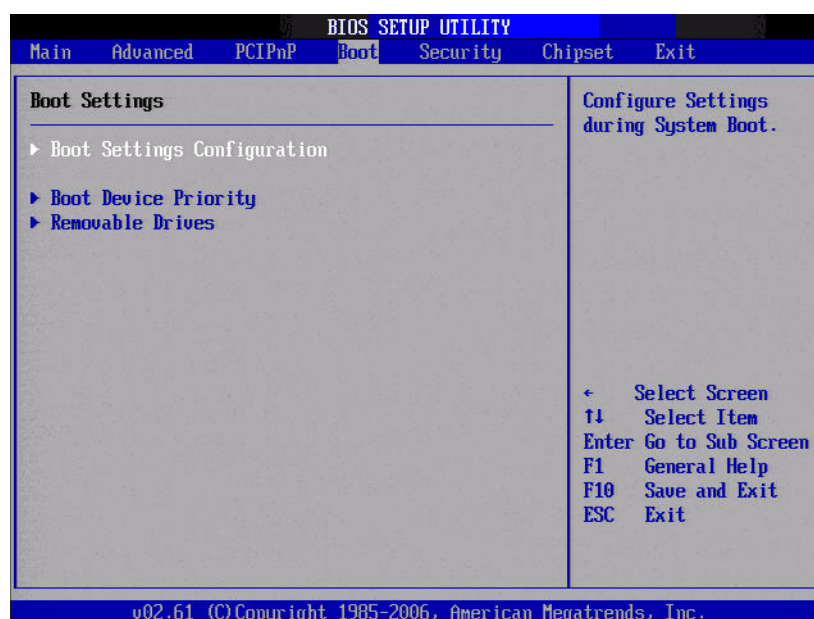

5.2.15 Boot settings Configuration

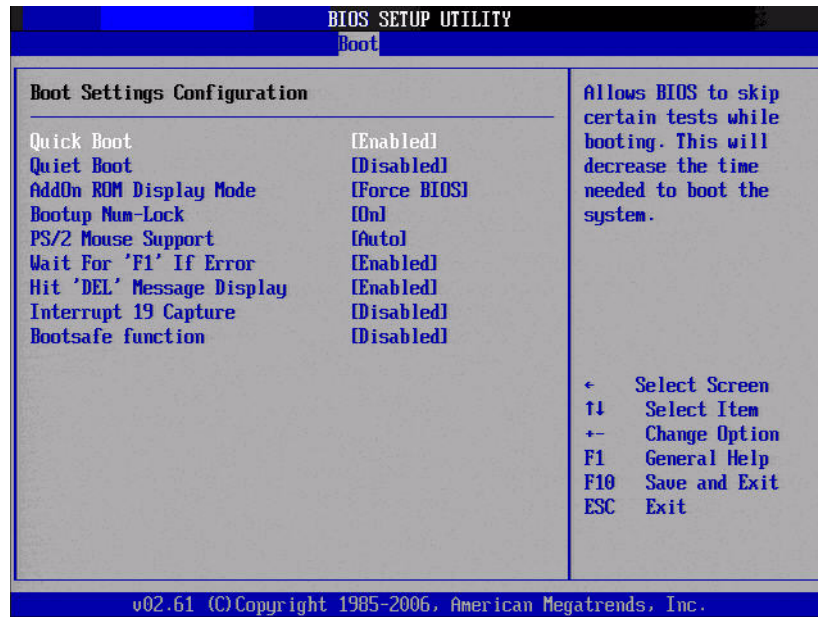

- **Quick Boot**
This item allows BIOS to skip certain tests while booting. This will decrease the time needed to boot the system.
- **Quiet Boot**
If this option is set to Disabled, the BIOS displays normal POST messages. If Enabled, an OEM Logo is shown instead of POST messages.
- **AddOn ROM Display Mode**
Set display mode for option ROM.
- **Bootup Num-Lock**
Select the Power-on state for Numlock.
- **PS/2 Mouse Support**
Select support for PS/2 Mouse.
- **Wait For .F1. If Error**
Wait for the F1 key to be pressed if an error occurs.
- **Hit .DEL. Message Display**
Displays .Press DEL to run Setup. in POST.
- **Interrupt 19 Capture**
This item allows option ROMs to trap interrupt 19.
- **Bootsafe Function**
This item allows you to enable or disable bootsafe function.

5.2.16 Security Setup

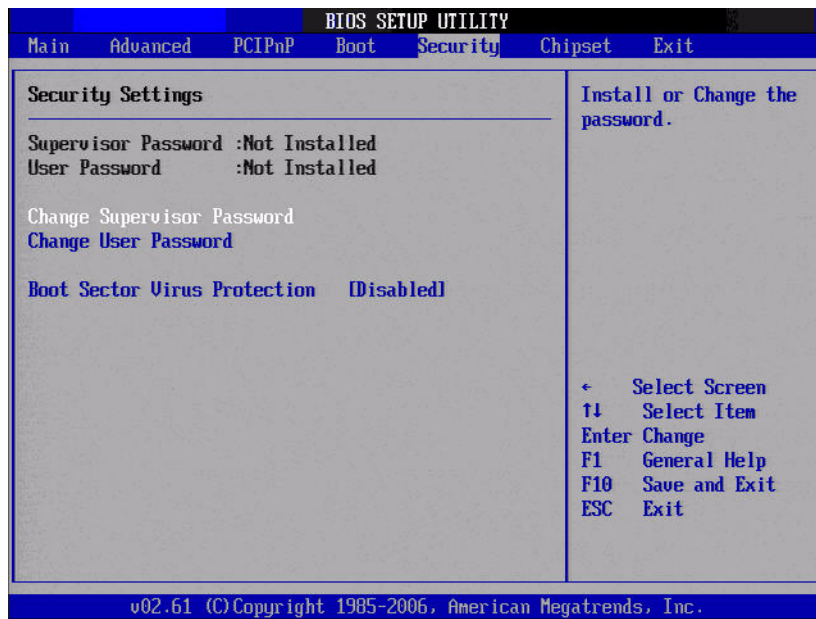

Select Security Setup from the PCM-9562 Setup main BIOS setup menu. All Security Setup options, such as password protection and virus protection are described in this section. To access the sub menu for the following items, select the item and press <Enter>:

- **Change Supervisor / User Password**
Provides for either installing or changing the password.
- **Boot sector Virus protection**
The boot sector virus protection will warn if any program tries to write to the boot sector.

5.2.17 Advanced Chipset Settings



5.2.18 North Bridge Chipset Configuration



- **DRAM Frequency**
This item allows you to manually change DRAM frequency.
- **Configure DRAM Timing by SPD**
This item allows you to enable or disable detect by DRAM SPD.
- **Initiate Graphic Adapter**
This item allows you to select which graphics controller to use as the primary boot device.
- **Internal Graphics Mode Select**
Select the amount of system memory used by the Internal graphics device.

5.2.19 Video Function Configuration

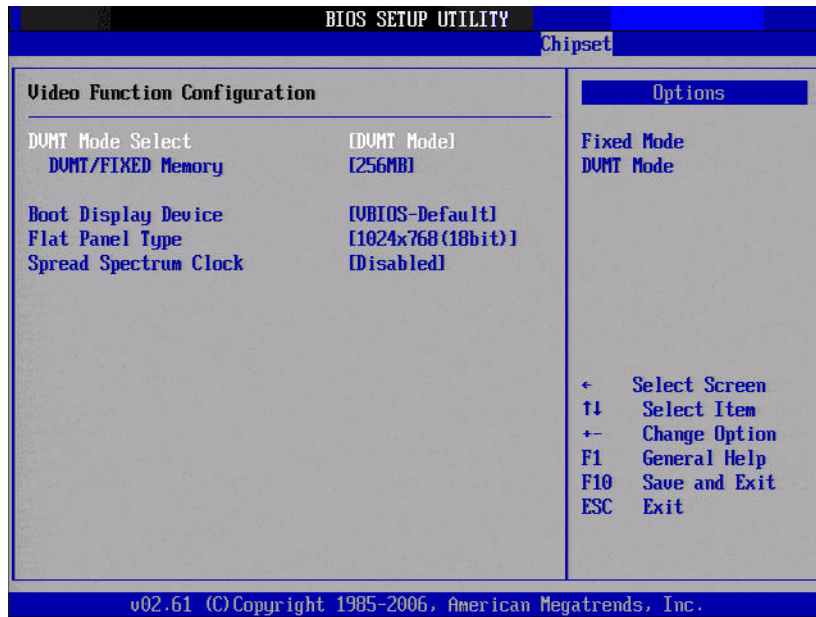

- **DVMT Mode Select**
Displays the active system memory mode.
- **DVMT/FIXED Memory**
Specifies the amount of DVMT / FIXED system memory to allocate for video memory.
- **Boot Display Device**
Select boot display device at post stage.
- **Flat Panel Type**
This item allows you to select which panel resolution you want.
- **Spread Spectrum Clock**
This item allows you to enable or disable spread spectrum clock.

5.2.20 South Bridge Chipset Configuration



- **USB Functions**
Select: Disabled, 2 USB Ports, 4 USB Ports, 6 USB Ports or 8 USB Ports.
- **USB 2.0 Controller**
Enables or disables the USB 2.0 controller.
- **LAN1 GbE controller**
Enables or disables the GbE controller.
- **LAN1 Option-ROM**
Enables or disables GbE LAN boot.
- **Resume on LAN1**
Enables or disables GbE LAN wake up from S5 function.
- **LAN2 GbE controller**
Enables or disables the GbE controller.
- **LAN2 Option-ROM**
Enables or disables GbE LAN boot.
- **Resume on LAN2**
Enables or disables GbE LAN wake up from S5 function.
- **HDA Controller**
Enables or disables the HDA controller.
- **SMBUS Controller**
Enables or disables the SMBUS controller.
- **SLP_S4# Min. Assertion Width**
This item allows you to set a delay of a set number of seconds.

5.2.21 Exit Option

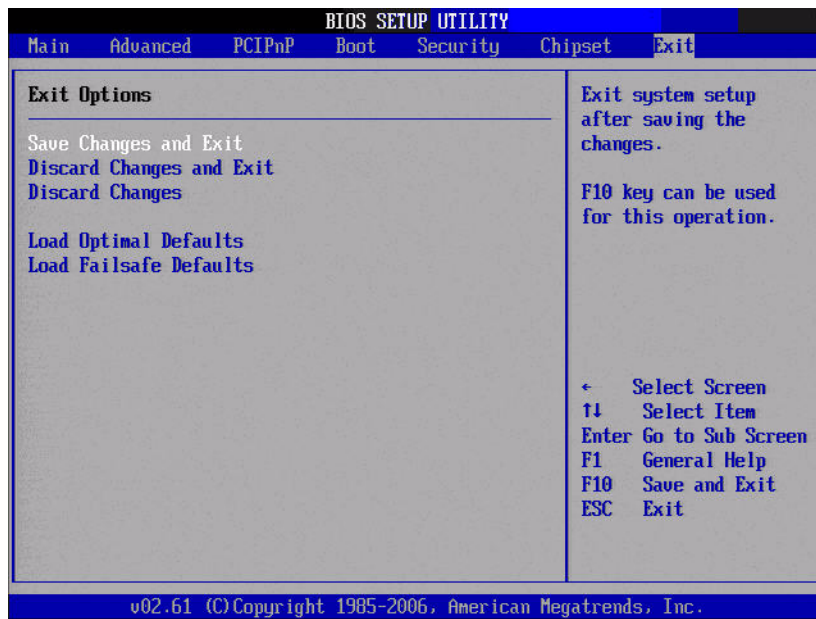

■ Save Changes and Exit

When you have completed system configuration, select this option to save your changes, exit BIOS setup and reboot the computer so the new system configuration parameters can take effect.

1. Select Save Changes and Exit from the Exit menu and press <Enter>. The following message appears:
Save Configuration Changes and Exit Now?
[Ok] [Cancel]
2. Select Ok or Cancel.

■ Discard Changes and Exit

Select this option to quit Setup without making any permanent changes to the system configuration.

1. Select Discard Changes and Exit from the Exit menu and press <Enter>. The following message appears:
Discard Changes and Exit Setup Now?
[Ok] [Cancel]
2. Select Ok to discard changes and exit.

■ Discard Changes

-
1. Select Discard Changes from the Exit menu and press <Enter>.

- **Load Optimal Defaults**

The IPC-100 automatically configures all setup items to optimal settings when you select this option. Optimal Defaults are designed for maximum system performance, but may not work best for all computer applications. In particular, do not use the Optimal.

Defaults if your computer is experiencing system configuration problems. Select Load Optimal Defaults from the Exit menu and press <Enter>.

- **Load Failsafe Defaults**

The IPC-100 automatically configures all setup options to failsafe settings when you select this option. Failsafe Defaults are designed for maximum system stability, but not maximum performance. Select Failsafe Defaults if your computer is experiencing system configuration problems.

1. Select Load Failsafe Defaults from the Exit menu and press <Enter>. The following message appears:
Load Failsafe Defaults?
[OK] [Cancel]
2. Select OK to load Failsafe defaults.

Chapter 6

Software Introduction
& Service

6.1 Introduction

The mission of Advantech Embedded Software Services is to "Enhance quality of life with Advantech platforms and Microsoft® Windows® embedded technology." We enable Windows® Embedded software products on Advantech platforms to more effectively support the embedded computing community. Customers are freed from the hassle of dealing with multiple vendors (hardware suppliers, system integrators, embedded OS distributors) for projects. Our goal is to make Windows® Embedded Software solutions easily and widely available to the embedded computing community.

6.2 Value-Added Software Services

Software API: An interface that defines the ways by which an application program may request services from libraries and/or operating systems. Provides not only the underlying drivers required but also a rich set of user-friendly, intelligent and integrated interfaces, which speeds development, enhances security and offers add-on value for Advantech platforms. It plays the role of catalyst between developer and solution, and makes Advantech embedded platforms easier and simpler to adopt and operate with customer applications.

6.2.1 Software API

6.2.1.1 Control

GPIO



General Purpose Input/Output is a flexible parallel interface that allows a variety of custom connections. Allows users to monitor the level of signal input or set the output status to switch on/off the device. Our API also provide Programmable GPIO, which allows developers to dynamically set the GPIO input or output status.

SMBus



SMBus is the System Management Bus defined by Intel Corporation in 1995. It is used in personal computers and servers for low-speed system management communications. The SMBus API allows a developer to interface a embedded system environment and transfer serial messages using the SMBus protocols, allowing multiple simultaneous device control.

6.2.1.2 Display

Brightness Control



The Brightness Control API allows a developer to access embedded devices and easily control brightness.

Backlight



The Backlight API allows a developer to control the backlight (screen) on/off in embedded devices.

6.2.1.3 Monitor

Watchdog



A watchdog timer (WDT) is a device that performs a specific operation after a certain period of time if something goes wrong and the system does not recover on its own. A watchdog timer can be programmed to perform a warm boot (restarting the system) after a certain number of seconds.

Hardware Monitor



The Hardware Monitor (HWM) API is a system health supervision API that inspects certain condition indexes, such as fan speed, temperature and voltage.

6.2.1.4 Power Saving

CPU Speed



Makes use of Intel SpeedStep technology to save power consumption. The system will automatically adjust the CPU speed depending on the system loading.

System Throttling

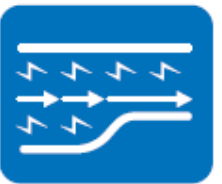

Refers to a series of methods for reducing power consumption in computers by lowering the clock frequency. This API allows the user to adjust the clock from 87.5% to 12.5%.

6.2.2 Software Utility

BIOS Flash

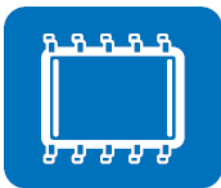

The BIOS Flash utility allows customers to update the flash ROM BIOS version, or use it to back up current BIOS by copying it from the flash chip to a file on customers' disk. The BIOS Flash utility also provides a command line version and an API for fast implementation into customized applications.

Embedded Security ID



The embedded application is the most important property of a system integrator. It contains valuable intellectual property, design knowledge and innovation, but it is easy to be copied! Embedded Security ID utility which provides reliable security functions for customers to secure their application data within embedded BIOS.

Monitoring



The Monitoring is a utility for customer to monitor the system health, like voltage, CPU and system temperature and fan speed. These items are important to a device, if the critical errors occur and are not solved immediately, permanent damage may be caused.

Flash Lock



Flash Lock is a mechanism to bind the Board and CF card (SQFlash) together. User can "Lock" SQFlash via Flash Lock function and "Unlock" by BIOS while booting. A locked SQFlash cannot be read by any card reader or boot from other platforms without a BIOS with "Unlock" feature.

eSOS



The eSOS is a small OS stored in BIOS ROM. It will boot up in case of a main OS crash. It will diagnose the hardware status, and then send an e-mail to the designated administrator. The eSOS also provide for remote connection via Telnet server and FTP server so the administrator can attempt to rescue the system. Note: This function requires BIOS customization.

Chapter 7

Chipset Software
Installation Utility

7.1 Before You Begin

To facilitate the installation of the enhanced display drivers and utility software, read the instructions in this chapter carefully. The drivers for the motherboard are located on the software installation CD. The driver in the folder of the driver CD will guide and link you to the utilities and drivers under a Windows system. Updates are provided via Service Packs from Microsoft*.

Note! *The files on the software installation CD are compressed. Do not attempt to install the drivers by copying the files manually. You must use the supplied SETUP program to install the drivers.*



Before you begin, it is important to note that most display drivers need to have the relevant software application already installed in the system prior to installing the enhanced display drivers. In addition, many of the installation procedures assume that you are familiar with both the relevant software applications and operating system commands. Review the relevant operating system commands and the pertinent sections of your application software's user manual before performing the installation.

7.2 Introduction

The Intel® Chipset Software Installation (CSI) utility installs the Windows INF files that outline to the operating system how the chipset components will be configured. This is needed for the proper functioning of the following features:

- Core PCI PnP services
- IDE Ultra ATA 100/66/33 and Serial ATA interface support
- USB 1.1/2.0 support (USB 2.0 driver needs to be installed separately for Win98)
- Identification of Intel® chipset components in the Device Manager
- Integrates superior video features. These include filtered sealing of 720 pixel DVD content, and MPEG-2 motion compensation for software DVD

Note! *This utility is used for the following versions of Windows, and it has to be installed **before** installing all the other drivers:*



- Windows 7
- Windows Vista
- Windows XP

7.3 Windows XP Driver Setup

Insert the driver CD into your system's CD-ROM drive. You can see the driver folder items. Navigate to the "Chipset" folder and click "infnst_autol.exe" to complete the installation of the driver.

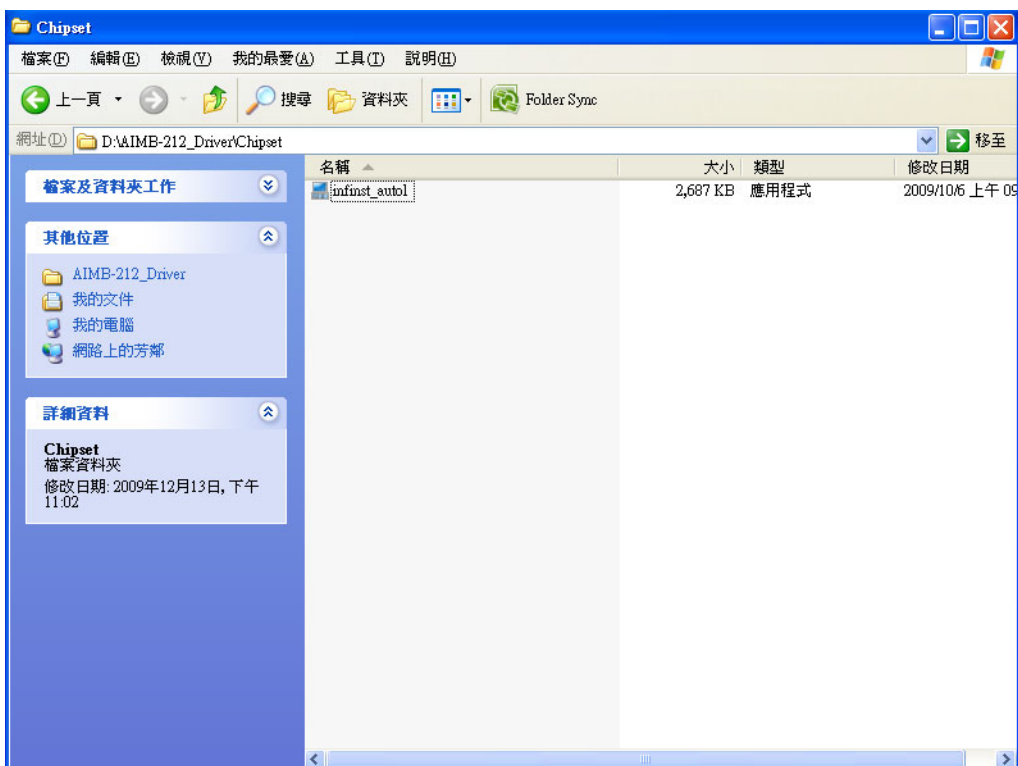
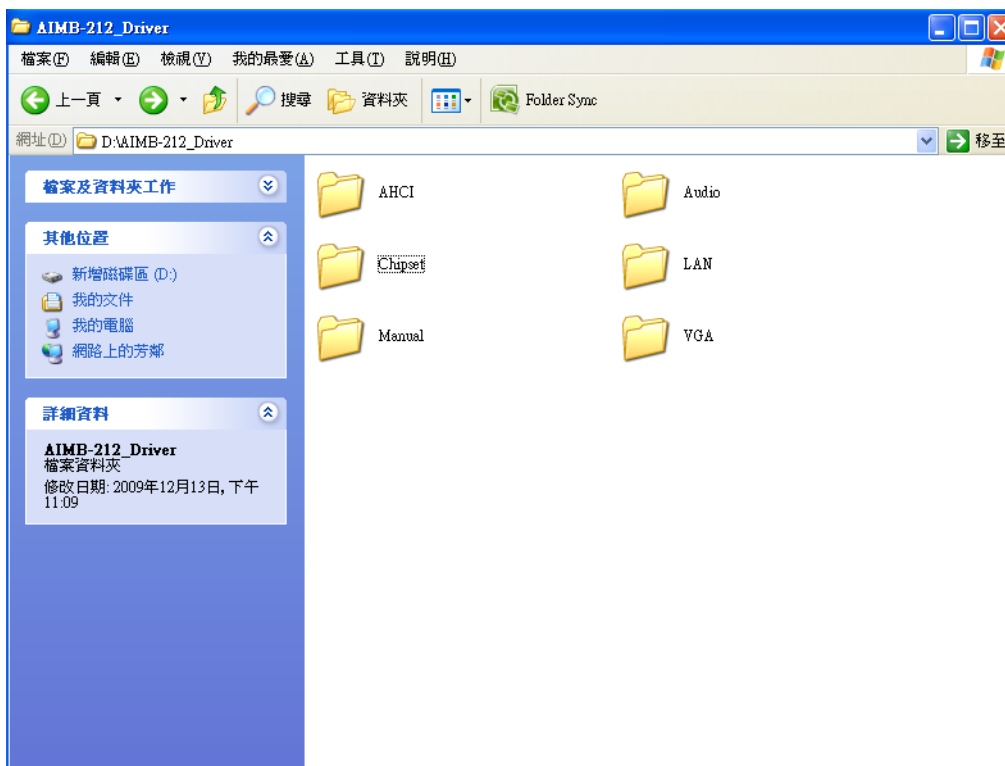

Chapter 8

VGA Setup

8.1 Introduction

To benefit from the Intel® Atom™ N450 integrated graphics controller, you need to install the graphic driver.

8.2 Windows 7/Vista/XP

Note! Before installing this driver, make sure the CSI utility has been installed in your system. See Chapter 5 for information on installing the CSI utility.



Insert the driver CD into your system's CD-ROM drive. You can see the driver folders items. Navigate to the "VGA" folder and click "setup.exe" to complete the installation of the drivers for Windows 7, Windows Vista, Windows XP.

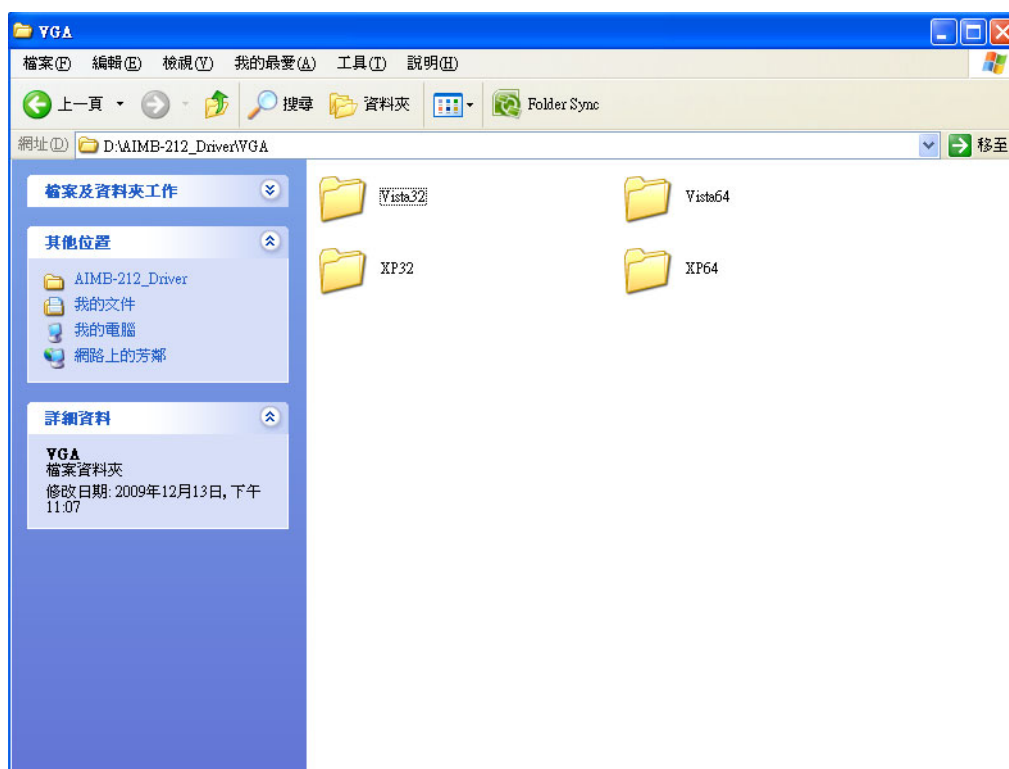

Chapter 9

LAN Configuration

9.1 Introduction

The motherboard has dual Gigabit Ethernet LANs via dedicated PCI Express x1 lanes (Intel 82567V (LAN1) and 82583V (LAN2)) that offer bandwidth of up to 500 MB/sec, eliminating the bottleneck of network data flow and incorporating Gigabit Ethernet at 1000 Mbps.

9.2 Features

- Integrated 10/100/1000 Mbps transceiver
- 10/100/1000 Mbps triple-speed MAC
- High-speed RISC core with 24-KB cache
- On-chip voltage regulation
- Wake-on-LAN (WOL) support
- PCI Express X1 host interface

9.3 Installation

Note! *Before installing the LAN drivers, make sure the CSI utility has been installed on your system. See Chapter 5 for information on installing the CSI utility.*



The Intel 82567V (LAN1) and 82583V (LAN2) Gigabit integrated controllers support all major network operating systems. However, the installation procedure varies from system to system. Please find and use the section that provides the driver setup procedure for the operating system you are using.

9.4 Windows 7/Vista/XP Driver Setup (Intel 82567v/82583v)

Insert the driver CD into the slim ODD. Select the LAN folder then navigate to the directory for your OS.

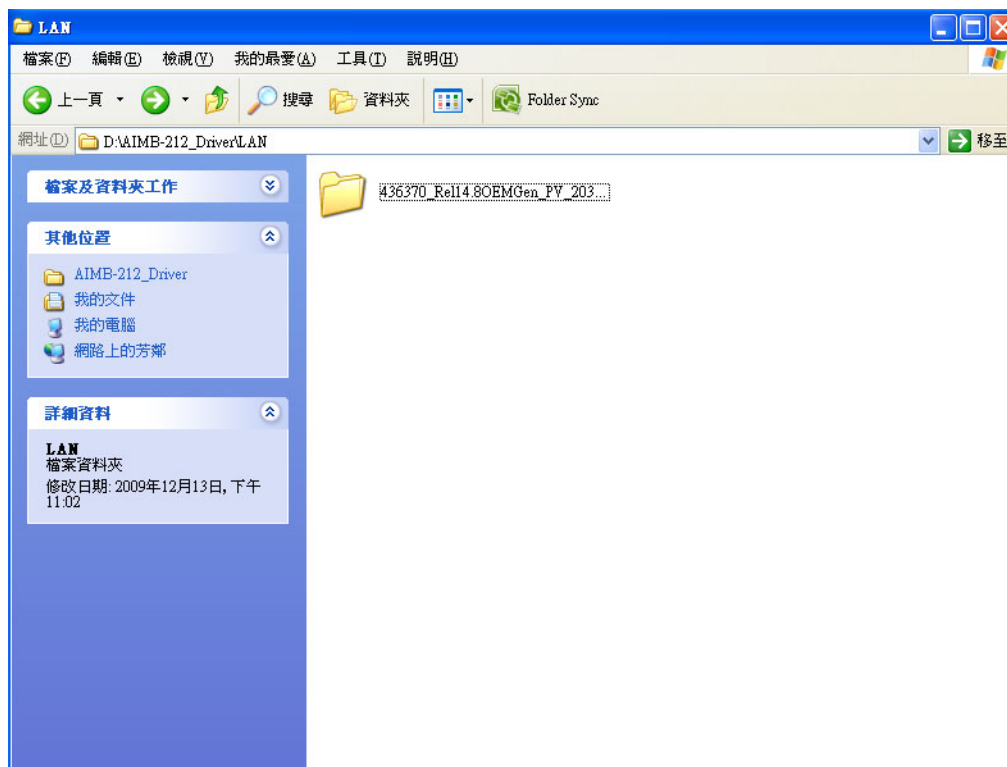

Appendix **A**

Exploded Diagram

A.1 Exploded Diagram

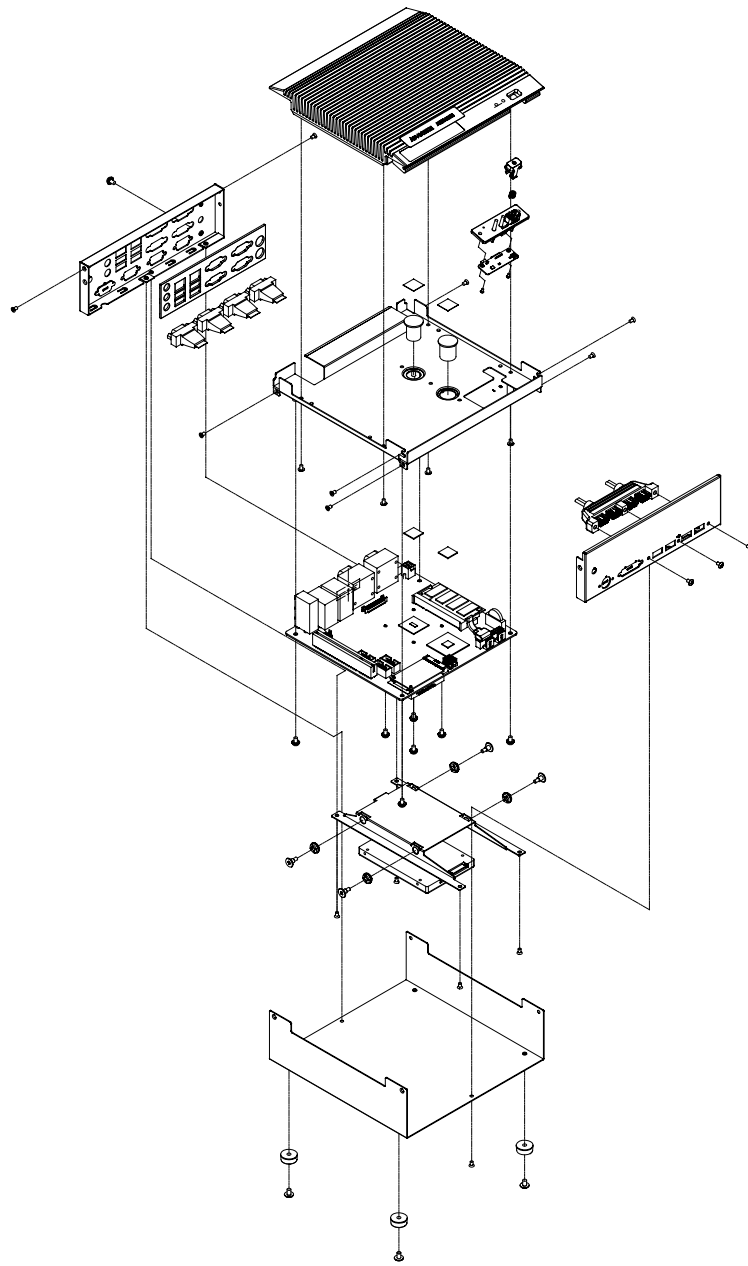

Figure A.1 Exploded diagram

Appendix **B**

Programming the
Watchdog Timer

B.1 Programming the Watchdog Timer

The IPC-100's watchdog timer can be used to monitor system software operation and take corrective action if the software fails to function within the programmed period. This section describes the operation of the watchdog timer and how to program it.

B.1.1 Watchdog Timer Overview

The watchdog timer is built into the super I/O controller W83627DHG-P. It provides the following user-programmable functions:

- Can be enabled and disabled by user program
- Timer can be set from 1 to 255 seconds or 1 to 255 minutes
- Generates an interrupt or resets signal if the software fails to reset the timer before time-out

B.1.2 Programming the Watchdog Timer

The I/O port address of the watchdog timer is 2E (hex) and 2F (hex). 2E (hex) is the address port. 2F (hex) is the data port. You must first assign the address of register by writing an address value into address port 2E (hex), then write/read data to/from the assigned register through data port 2F (hex).

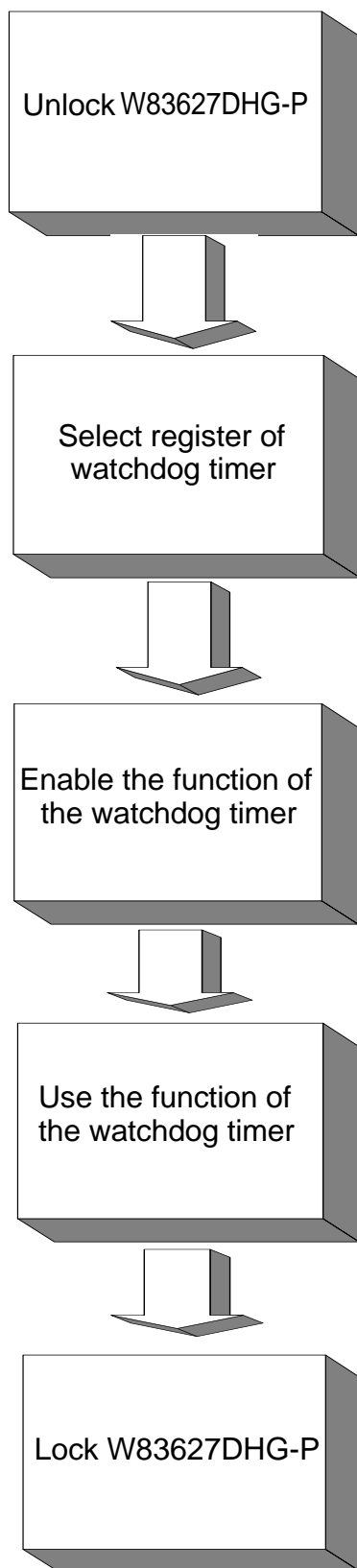

Table B.1: Watchdog Timer Registers

Address of Register (2E) Attribute		
Read/Write	Value (2F) & description	
87 (hex)	-----	Write this address to I/O address port 2E (hex) twice to unlock the W83627DHG-P.
07 (hex)	write	Write 08 (hex) to select register of watchdog timer.
30 (hex)	write	Write 01 (hex) to enable the function of the watchdog timer. Disabled is set as default.
F5 (hex)	write	Set seconds or minutes as units for the timer. Write 0 to bit 3: set second as counting unit. [default] Write 1 to bit 3: set minutes as counting unit.
F6 (hex)	write	0: stop timer [default] 01~FF (hex): The amount of the count, in seconds or minutes, depends on the value set in register F5 (hex). This number decides how long the watchdog timer waits for strobe before generating an interrupt or reset signal. Writing a new value to this register can reset the timer to count with the new value.
F7 (hex)	read/write	Bit 7: Write 1 to enable mouse to reset the timer, 0 to disable [default]. Bit 6: Write 1 to enable keyboard to reset the timer, 0 to disable. [default] Bit 5: Write 1 to generate a timeout signal immediately and automatically return to 0. [default=0] Bit 4: Read status of watchdog timer, 1 means timer is "timeout".
AA (hex)	-----	Write this address to I/O port 2E (hex) to lock the watchdog timer 2.

B.1.3 Example Program

1. Enable watchdog timer and set 10 sec. as timeout interval

```

;-----
Mov dx,2eh ; Unlock W83627DHG-P
Mov al,87h
Out dx,al
Out dx,al
;-----
Mov al,07h ; Select registers of watchdog timer
Out dx,al
Inc dx
Mov al,08h
Out dx,al
;-----
Dec dx ; Enable the function of watchdog timer
Mov al,30h
Out dx,al
Inc dx
Mov al,01h
Out dx,al
;-----
Dec dx ; Set second as counting unit
Mov al,0f5h
Out dx,al
Inc dx
In al,dx
And al,not 08h
Out dx,al
;-----
Dec dx ; Set timeout interval as 10 seconds and start counting
Mov al,0f6h
Out dx,al
Inc dx
Mov al,10
Out dx,al
;-----
Dec dx ; Lock W83627DHG-P
Mov al,0aah
Out dx,al

```

2. Enable watchdog timer and set 5 minutes as timeout interval

```

;-----
Mov dx,2eh ; Unlock W83627DHG-P
Mov al,87h
Out dx,al
Out dx,al

```

```

;-----
Mov al,07h ; Select registers of watchdog timer
Out dx,al
Inc dx
Mov al,08h
Out dx,al
;-----
Dec dx ; Enable the function of watchdog timer
Mov al,30h
Out dx,al
Inc dx
Mov al,01h
Out dx,al
;-----
Dec dx ; Set minute as counting unit
Mov al,0f5h
Out dx,al
Inc dx
In al,dx
Or al,08h
Out dx,al
;-----
Dec dx ; Set timeout interval as 5 minutes and start counting
Mov al,0f6h
Out dx,al
Inc dx
Mov al,5
Out dx,al
;-----
Dec dx ; Lock W83627DHG-P
Mov al,0aah
Out dx,al
3. Enable watchdog timer to be reset by mouse
;-----
Mov dx,2eh ; Unlock W83627DHG-P
Mov al,87h
Out dx,al
Out dx,al
;-----
Mov al,07h ; Select registers of watchdog timer
Out dx,al
Inc dx
Mov al,08h
Out dx,al
;-----

```

```

Dec dx ; Enable the function of watchdog timer
Mov al,30h
Out dx,al
Inc dx
Mov al,01h
Out dx,al
;-----
Dec dx ; Enable watchdog timer to be reset by mouse
Mov al,0f7h
Out dx,al
Inc dx
In al,dx
Or al,80h
Out dx,al
;-----
Dec dx ; Lock W83627DHG-P
Mov al,0aah
Out dx,al
4. Enable watchdog timer to be reset by keyboard
;-----
Mov dx,2eh ; Unlock W83627DHG-P
Mov al,87h
Out dx,al
Out dx,al
;-----
Mov al,07h ; Select registers of watchdog timer
Out dx,al
Inc dx
Mov al,08h
Out dx,al
;-----
Dec dx ; Enable the function of watchdog timer
Mov al,30h
Out dx,al
Inc dx
Mov al,01h
Out dx,al
;-----
Dec dx ; Enable watchdog timer to be strobed reset by keyboard
Mov al,0f7h
Out dx,al
Inc dx
In al,dx
Or al,40h
Out dx,al

```

```

;-----
Dec dx ; Lock W83627DHG-P
Mov al,0aah
Out dx,al
5. Generate a time-out signal without timer counting
;-----
Mov dx,2eh ; Unlock W83627DHG-P
Mov al,87h
Out dx,al
Out dx,al
;-----
Mov al,07h ; Select registers of watchdog timer
Out dx,al
Inc dx
Mov al,08h
Out dx,al
;-----
Dec dx ; Enable the function of watchdog timer
Mov al,30h
Out dx,al
Inc dx
Mov al,01h
Out dx,al
;-----
Dec dx ; Generate a time-out signal
Mov al,0f7h
Out dx,al ;Write 1 to bit 5 of F7 register
Inc dx
In al,dx
Or al,20h
Out dx,al
;-----
Dec dx ; Lock W83627DHG-P
Mov al,0aah
Out dx,al

```

Appendix **C**

I/O Pin Assignments

C.1 USB Header (USB56, USB78)

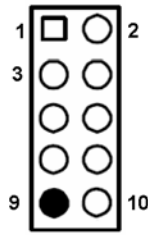

Table C.1: USB Header (USB56)

Pin	Signal	Pin	Signal
1	USB0_VCC5	2	USB1_VCC5
3	USB0_D-	4	USB1_D-
5	USB0_D+	6	USB1_D+
7	GND	8	GND
9	Key	10	GND

C.2 VGA Connector (VGA1)

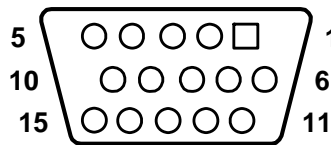

Table C.2: VGA Connector (VGA1)

Pin	Signal	Pin	Signal
1	RED	9	CRT_VCCIN
2	VGA_G	10	GND
3	VGA_B	11	N/C
4	N/C	12	V_SDAT
5	GND	13	H-SYNC
6	GND	14	V-SYNC
7	GND	15	V_SCLK

C.3 RS-232 Interface

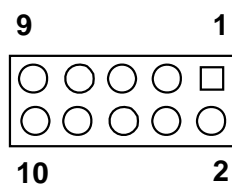

Table C.3: RS-232 Interface (COM4~COM6)

Pin	Signal	Pin	Signal
1	DCD	2	DSR
3	RXD	4	RTS
5	TXD	6	CTS
7	DTR	8	RRI
9	GND	10	-

C.4 RS-232/422/485 Setting Interface (JETCOM2)

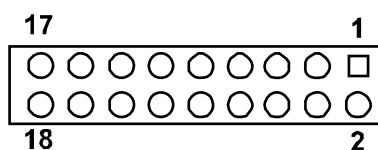

Table C.4: RS-232/422/485 Setting Interface (JETCOM2)

Pin	Signal	Pin	Signal
1	R_SINA	2	RXD485_1
3	R_SINA	4	RXD422_1
5	R_SINA	6	RXD232_1
7	DCDA	8	SOUTA
9	COM1_DCD#	10	COM1_SOUT
11	COM1_TXD485N	12	COM1_RXD485P
13	SINA	14	DTRA
15	COM1_SIN	16	COM1_DTR#
17	COM1_TXD485P	18	COM1_RXD485N

C.5 SPI_CN1: SPI Fresh Card Pin Connector

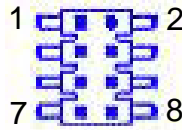

Table C.5: SPI_CN1:SPI Fresh Card Pin Connector

Pin	Signal	Pin	Signal
1	+F1_3V	2	GND
3	F1_SPI_CS#_Q	4	F1_SPI_CLK_Q
5	F1_SPI_MISO_Q	6	F1_SPI_MOSI_Q
7	NC	8	NC

C.6 PS/2 Keyboard and Mouse Connector (KBMS1)

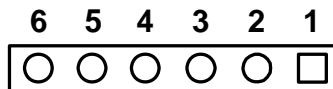

Table C.6: PS/2 Keyboard and Mouse Connector (KBMS1)

Pin	Signal
1	KCLK_B
2	KDAT_B
3	MDAT_B
4	GND
5	KBMS1_VCC
6	MCLK_B

C.7 CPU Fan Power Connector (CPU_FAN1)

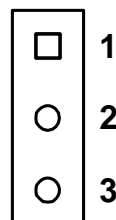

Table C.7: CPU Fan Power Connector (CPU_FAN1)

Pin	Signal
1	GND
2	+12 V
3	DETECT

C.8 System Fan Power Connector (CHA_FAN1)

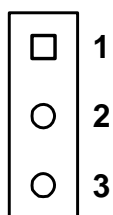

Table C.8: System Fan Power Connector (SYSFAN1/SYSFAN2)

Pin	Signal
1	GND
2	+12 V
3	DETECT

C.9 Power LED & Keyboard Lock Connector (JFP1)

You can use an LED to indicate when the single board computer is on. Pin 1 of JFP3 supplies the LED's power, and Pin 3 is the ground.

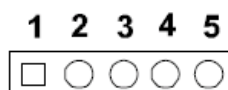

Table C.9: Power LED & Keyboard Lock Connector (JFP1)

Pin	Function
1	LED power
2	NC
3	GND
4	KEYLOCK#
5	GND

C.10 Power switch/HDD LED/SMBus/Speaker (JFP1+JFP2)

The single board computer has its own buzzer. You can also connect it to the external speaker on your computer chassis.

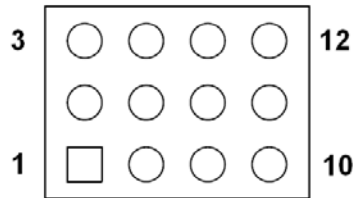

Table C.10: Power Switch/HDD LED/SMBus/Speaker (JFP1+JFP2)

Pin	Signal	Pin	Signal
1	SPK_P1	2	HDDLED+
3	PWR	4	NC
5	HDDLED-	6	GND
7	SPK_P3	8	SMB_DAT
9	SYS_RST	10	SPK_P4
11	SMB_CLK	12	GND

C.11 USB/LAN ports (LAN1_USB12/LAN2_USB34)

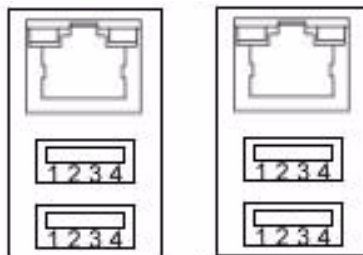

Table C.11: USB Port

Pin	Signal	Pin	Signal
1	VCC	3	Data0+
2	Data0-	4	GND

Table C.12: Ethernet 10/100 Mbps RJ-45 Port

Pin	Signal	Pin	Signal
1	XMT+	5	N/C
2	XMT-	6	RCV-
3	RCV+	7	N/C
4	N/C	8	N/C

C.12 Line Out, Mic In Connector (AUDIO1)

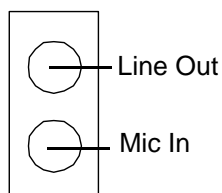

C.13 Serial ATA0/1 (SATA1/SATA2)

Table C.13: Serial ATA 0/1 (SATA1/SATA2)

Pin	Signal	Pin	Signal
1	GND	2	SATA_0TX+
3	SATA_0TX-	4	GND
5	SATA_0RX-	6	SATA_0RX+
7	GND	8	

C.14 AT/ATX Mode (PSON1)

Table C.14: AT/ATX Mode (PSON1)

Pin	Signal	Pin	Signal
1	#PSON_SIO (to super IO)	2	#PSON (to power supply)
3	GND		

C.15 HD Audio Interface (HD1)

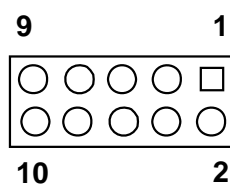

Table C.15: AC-97 Audio Interface (HD1)

Pin	Signal	Pin	Signal
1	MIC2_L	2	GND
3	MIC2_R	4	FP_AUD_DET
5	LOUT2_R	6	SRTN1
7	LOUT2_DET	8	KEY
9	LOUT2_L	10	SRTN2

C.16 DMA Channel Assignments

Table C.16: DMA Channel Assignments

Channel	Function
0	Available
1	Available
2	Floppy disk (8-bit transfer)
3	Available
4	Cascade for DMA controller 1
5	Available
6	Available
7	Available

C.17 Interrupt Assignments

Table C.17: Interrupt Assignments

Priority	Interrupt#	Interrupt source
1	NMI	Parity error detected
2	IRQ0	Interval timer
3	IRQ1	Keyboard
-	IRQ2	Interrupt from controller 2 (cascade)
4	IRQ8	Real-time clock
5	IRQ9	Cascaded to INT 0A (IRQ 2)
6	IRQ10	Serial communication port 4/6
7	IRQ11	Serial communication port 3/5
8	IRQ12	PS/2 mouse
9	IRQ13	INT from co-processor
10	IRQ14	Primary IDE Channel
11	IRQ15	Secondary IDE Channel
12	IRQ3	Serial communication port 2
13	IRQ4	Serial communication port 1
14	IRQ5	Available
15	IRQ6	Available
16	IRQ7	Parallel port 1 (print port)

C.18 1st MB Memory Map

Table C.18: 1st MB Memory Map

Addr. range (Hex)	Device
E0000h - FFFFFh	BIOS
CC000h - DFFFFh	Unused
C0000h - CBFFFh	VGA BIOS
A0000h - BFFFFh	Video Memory
00000h - 9FFFFh	Base memory

Trusted ePlatform Services

ADVANTECH

www.advantech.com

Please verify specifications before quoting. This guide is intended for reference purposes only.

All product specifications are subject to change without notice.

No part of this publication may be reproduced in any form or by any means, electronic, photocopying, recording or otherwise, without prior written permission of the publisher.

All brand and product names are trademarks or registered trademarks of their respective companies.

© Advantech Co., Ltd. 2010