



SPECIFICATION SHEET

SPECIFICATION SHEET NO.	N0723- 0805B334K250CC
DATE	July 23, 2021
REVISION	A0
DESCRIPTION	Multilayer Ceramic Chip Capacitors 0805 (2012 Metric) Series, L2.00*W1.25*H1.25mm, Dielectric X7R, Capacitance 330nF, Tolerance ±10%, Rated Voltage 25V Operating Temp. Range -55°C ~+125°C Package in Tape/Reel, 3,000pcs/Reel RoHS/RoHS III compliant
CUSTOMER	
CUSTOMER PART NUMBER	
CROSS REF. PART NUMBER	
ORIGINAL PART NUMBER	Aillen 0805B334K250CC
PART CODE	0805B334K250CC

VENDOR APPROVE			
Issued/Checked/Approved			
DATE: July 23, 2021			

CUSTOMER APPROVE	
DATE:	

MULTILAYER CERAMIC CHIP CAPACITORS 0805 SERIES

MAIN FEATURE

- RoHS III Compliant
- Wide Operating Temperature Range -55~+125°C
- High Capacitance in small size
- Small size L2.00*W1.25*H1.25mm, 2 Pads

APPLICATION

- General Digital Circuit
- Power Supply by pass capacitors
- Consumer Electronics
- Telecommunication

RFQ
Request For Quotation

PART CODE GUIDE

0805	B	334	K	250	C	C
1	2	3	4	5	6	7

- 1) **0805**: Series code for Multilayer Ceramic Chip Capacitors, Dimension L2.00*W1.25*H1.25mm, 0805 (2012 Metric) Series
- 2) **B**: Dielectric code X7R
- 3) **334**: Capacitance Code, Two significant digits followed by number of Zero, The 3rd digit signifies the multiplying factor, and letter R is decimal point, Example: 334 = $33 \times 10^4 = 330,000 \text{ pF} = 330 \text{ nF} = 0.33 \mu\text{F}$
- 4) **K**: Capacitance Tolerance code, B: +/-0.1pF; C: +/-0.25pF; K: +/-10%
- 5) **250**: Rated Voltage Code: Two significant digits followed by number of Zero and letter R is decimal point, 250= 25 VDC
- 6) **C**: Thickness code, 1.25+/-0.20mm
- 7) **C**: Tape/Reel code, Packed in Tape/Reel. 3,000pcs/Reel

MULTILAYER CERAMIC CHIP CAPACITORS 0805 SERIES

DIMENSION (Unit: mm)

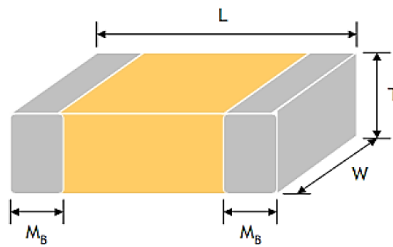

Image for reference



Marking: Blank

0805



Item	Dimension
L	2.00±0.20
W	1.25±0.20
T	1.25±0.20
M B	0.50±0.20

MLCC construction for Reference

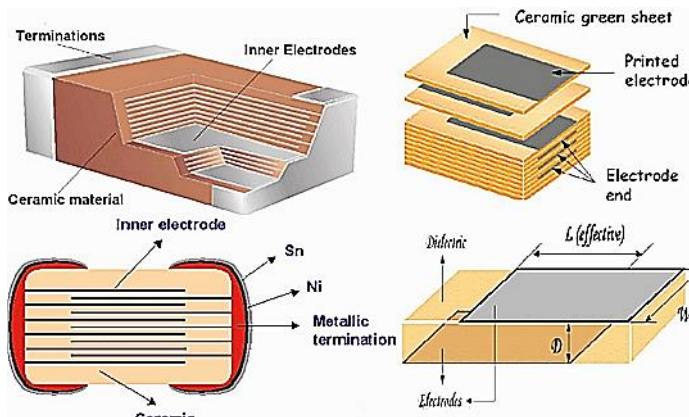

MULTILAYER CERAMIC CHIP CAPACITORS 0805 SERIES

GENERAL ELECTRONICAL CHARACTERISTICS

Item	Unit	Symbol	Characteristic	Condition
Size		0805	Dimension L2.00*W1.25*H1.25mm, 0805 (2012 Metric) Series	
Dielectric		B	X7R	
Capacitance Range	nF	334	330	
Capacitance Tolerance	%	K	±10	
Rated Voltage	VDC	250	25	
Operating Temperature	°C		-55 ~+125	
Capacitance Characteristic	%		±15	
Termination			Ni/Sn (Lead- Free)	

X7R

Table 1

Rated Voltage	D.F ≤	Exception of D.F. ≤	
25V	3.5%	≤5%	≥1.0μF
		≤ 10 %	≥2.2μF

MULTILAYER CERAMIC CHIP CAPACITORS 0805 SERIES
RELIABILITY TEST CONDITIONS AND REQUIREMENTS

Item	Test Condition	Requirements
Visual and Mechanical	-	No remarkable defect. Dimensions to conform to individual specification sheet.
Capacitance	Class II: (X7R) $C \leq 10\mu\text{F}$, $1.0 \pm 0.2V_{\text{rms}}$ $1\text{KHz} \pm 10\%$	* Shall not exceed the limits given in the detailed spec.
Q/D.F. (Dissipation Factor)	Test condition: $0.5 \pm 0.2V_{\text{rms}}$, $1\text{KHz} \pm 10\%$ *Before initial measurement (Class II only): To apply de-aging at 150°C for 1hr for 24 ± 2 hrs at room temp.	See Table 1
Dielectric Strength	* To apply voltage ($\leq 100\text{V}$) 250%. * Duration: 1 to 5 sec. * Charge and discharge current less than 50mA.	No evidence of damage or flash over during test.
Insulation Resistance	* Preconditioning for Class II MLCC: Perform a heat treatment at $150 \pm 10^\circ\text{C}$ for 1 hour, then leave in ambient condition for 24 ± 2 hours before measurement. To apply rated voltage for max. 120 sec.	Class II (X7R) $10\text{G}\Omega$ or $R_{\text{xC}} \geq 500\Omega\text{-F}$ whichever is smaller. 25V : $\geq 2.2\mu\text{F}$ IR : $1\text{G}\Omega$ or $R_{\text{xC}} \geq 100\Omega\text{-F}$ whichever is Smaller
Temperature Coefficient	With no electrical load, Operating Temp. $-55 \sim 125^\circ\text{C}$ at 25°C *Before initial measurement (Class II only): To apply de-aging at 150°C for 1hr then set for 24 ± 2 hrs at room temp. *Measurement voltage for Class II: Capacitance $< 10\mu\text{F}$: 1.0V	Operating Temperature tolerance: $\pm 15\%$

MULTILAYER CERAMIC CHIP CAPACITORS 0805 SERIES
RELIABILITY TEST CONDITIONS AND REQUIREMENTS

Item	Test Condition	Requirements
Adhesive Strength of Termination	* Pressurizing force: 10N (>0603) * Test time: 10 ± 1 sec.	No remarkable damage or removal of the terminations.
Vibration Resistance	* Vibration frequency: 10~55 Hz/min. * Total amplitude: 1.5mm * Test time: 6 hrs. (Two hrs each in three mutually perpendicular directions.) * Before initial measurement (Class II only): To apply de-aging at 150° C for 1hr then set for 24 ± 2 hrs at room temp. * Cap./DF(Q) Measurement to be made after de-aging a 150° C for 1hr then set for 24 ± 2 hrs at room temp.	* No remarkable damage or removal of the terminations. * No remarkable damage. * Cap change and Q/D.F.: To meet initial spec.
Solder ability	* Solder temperature: 235 ± 5°C * Dipping time: 2 ± 0.5 sec.	95% min. coverage of all metalized area.
Bending Test	* The middle part of substrate shall be pressurized by means of the pressurizing rod at a rate of about 1 mm per second until the deflection becomes 1 mm and then the pressure shall be maintained for 5 ± 1 sec. * Before initial measurement (Class II only): To apply de-aging at 150°C for 1hr then set for 24 ± 2 hrs at room temp. * Measurement to be made after keeping at room temp. for 24 ± 2 hrs.	* No remarkable damage. * Cap change: within ± 12.5% (This capacitance change means the change of capacitance under specified flexure of substrate from the capacitance measured before the test.)
Resistance to Soldering Heat	* Solder temperature: 260 ± 5°C * Dipping time: 10 ± 1 sec * Preheating: 120 to 150° C for 1 minute before immerse the capacitor in a eutectic solder. * Before initial measurement (Class II only): To apply de-aging at 150°C for 1hr then set for 24 ± 2 hrs at room temp. * Cap. / DF(Q) / I.R. Measurement to be made after de-aging at 150°C for 1hr then set for 24 ± 2 hrs at room	* No remarkable damage. * Cap change: X7R within ± 7.5% * Q/D.F., I.R. and dielectric strength: To meet initial requirements. * 25% max. leaching on each edge.

MULTILAYER CERAMIC CHIP CAPACITORS 0805 SERIES
RELIABILITY TEST CONDITIONS AND REQUIREMENTS

Item	Test Condition	Requirements
Temperature Cycle	<p>* Conduct the five cycles according to the temperatures and time.</p> <p>Step 1: Time: 30+/-3 Minutes@+0/-3 °C Min. Step 2: Time: 2~3 Minutes@+25 °C Step 3: Time: 30+/-3 Minutes@+3/-0 °C Max. Step 4: Time: 2~3 Minutes@+25 °C</p> <p>* Before initial measurement (Class II only): Perform 150+0/-10°C for 1 hr and then set for 24 ± 2 hrs at room temp. * Cap. / DF(Q) / I.R. Measurement to be made after de-aging at 150°C for 1hr then set for 24 ± 2 hrs at room.</p>	<p>* No remarkable damage. * Cap change: X7R: within ± 7.5% * Q/D.F., I.R. and dielectric strength: To meet initial requirements.</p>
Humidity (Damp Heat) Steady State	<p>* Test temp.: 40 ± 2 °C * Humidity: 90~95% RH * Test time: 500+24/-0hrs. * Before initial measurement (Class II only): Perform 150+0/-10 °C for 1 hr and then set for 24 ± 2 hrs at room temp.</p> <p>* Cap. / DF(Q) / I.R. Measurement to be made after de-aging at 150 °C for 1hr then set for 24 ± 2 hrs at room temp.</p>	<p>* No remarkable damage. * Cap change: X7R: ≥10V, within ±12.5 * Q/D.F. value: X7R: See Table 1</p> <p>* I.R.: ≥10V, 1GΩ or 50 Ω-F whichever is smaller. Class II (X7R): 25V ≥2.2μF, IR: 1GΩ or RxC ≥ 10 Ω-F whichever is smaller.</p>
Humidity (Damp Heat) Load	<p>* Test temp.: 40±2°C * Humidity: 90~95%RH * Test time: 500+24/-0 hrs. * To apply voltage: rated voltage.</p> <p>• Before initial measurement (Class II only): To apply de-aging at 150°C for 1hr then set for 24±2 hrs at room temp.</p> <p>* Cap. / DF(Q) / I.R. Measurement to be made after de-aging at 150°C for 1hr. then set for 24±2 hrs at room temp</p>	<p>* No remarkable damage. Cap change: X7R: ≥10V**within ±12.5%</p> <p>Q/D.F. value: X7R: See Table 1</p> <p>* I.R.: ≥10V, 500MΩ or 25 Ω-F whichever is smaller. Class II (X7R): 25V ≥2.2μF, IR: 1GΩ or RxC ≥ 10 Ω-F whichever is smaller.</p>

MULTILAYER CERAMIC CHIP CAPACITORS 0805 SERIES

RELIABILITY TEST CONDITIONS AND REQUIREMENTS

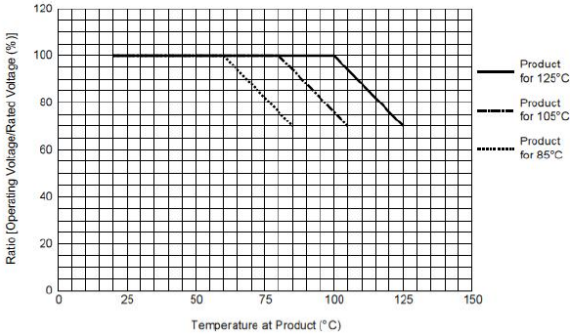
Item	Test Condition	Requirements
<p>High Temperature Load (Endurance)</p>	<p>*Test temp.: X7R: $125 \pm 3^\circ\text{C}$</p> <p>*Test time: 1000+24/-0 hrs.</p> <p>*To apply voltage: $10\text{V} \leq U_r < 500\text{V}$: 200% of rated voltage.</p> <p>* Before initial measurement (Class II only): To apply de-aging at 150°C for 1hr then set for 24 ± 2 hrs at room temp.</p> <p>* Cap. / DF(Q) / I.R. Measurement to be made after de-aging at 150°C for 1hr then set for 24 ± 2 hrs at room temp.</p> <p>** De-rating conditions</p> 	<p>* No remarkable damage. Capacitance change:</p> <p>X7R: $\geq 10\text{V}$, within $\pm 12.5\%$</p> <p>D.F. value: X7R: See See Table 1</p> <p>*I.R.: $\geq 10\text{V}$, $500\text{M}\Omega$ or $25 \Omega\text{-F}$ whichever is smaller. Class II (X7R): $25\text{V} \geq 2.2\mu\text{F}$,</p> <p>IR: $1\text{G}\Omega$ or $R_x C \geq 10 \Omega\text{-F}$ whichever is smaller.</p>

MULTILAYER CERAMIC CHIP CAPACITORS 0805 SERIES

STORAGE AND HANDLING CONDITIONS

- (1) To store products at 5 to 40°C ambient temperature and 20 to 70% related humidity conditions.
- (2) The product is recommended to be used within one year after shipment. Check solder ability in case of shelf life extension is needed.
- (3) Don't open the tape until the parts are to be used, use the chips within 3 months after the tape is opened.
- (4) For product of high dielectric constant (Class2&3, characteristics B/W & Y), the Electro static capacity changes with the passage of time due to the inherent characteristics of ceramic dielectric materials. The changed capacity reverts to nominal at the temperature it reaches during the soldering process.

CAUTIONS

- (1) The corrosive gas reacts on the terminal electrodes of capacitors, and results in the poor solder ability. Do not store the capacitors in the ambience of corrosive gas (e.g., hydrogen sulfide, sulfur dioxide, chlorine, ammonia gas etc.)
- (2) In corrosive atmosphere, solder ability might be degraded, and silver migration might occur to cause low reliability.
- (3) Due to the dewing by rapid humidity change, or the photochemical change of the terminal electrode by direct sun light, the solder ability and electrical performance may deteriorate. Do not store capacitors under direct sunlight or dewing condition. To store products on the shelf and avoid exposure to moisture.

MULTILAYER CERAMIC CHIP CAPACITORS 0805 SERIES

RECOMMENDED PROFILE CONDITIONS

The lead-free termination MLCCs are not only to be used on SMT against lead-free solder paste, but also suitable against lead-containing solder paste.

If the optimized solder joint is requested, increasing soldering time, temperature and concentration of N2 within oven are recommended.

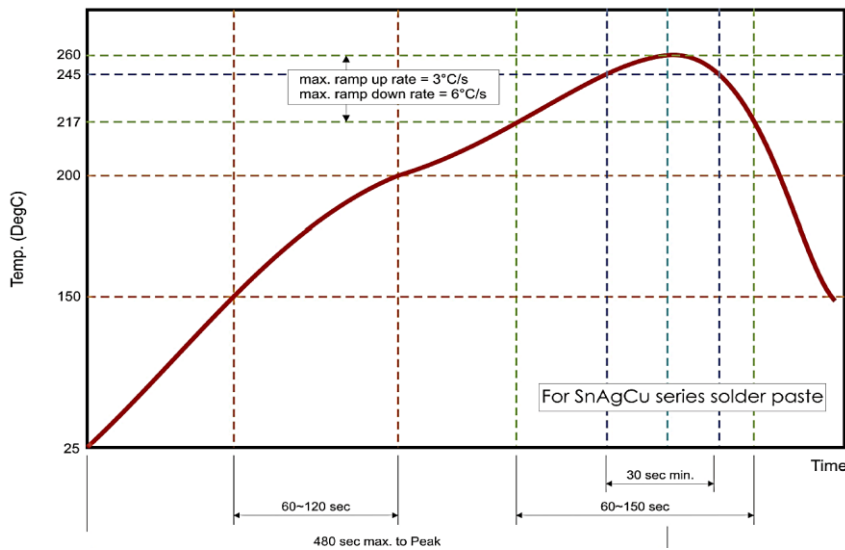

Reflow Soldering Profile For SMT Process with SnAgCu series Solder Paste

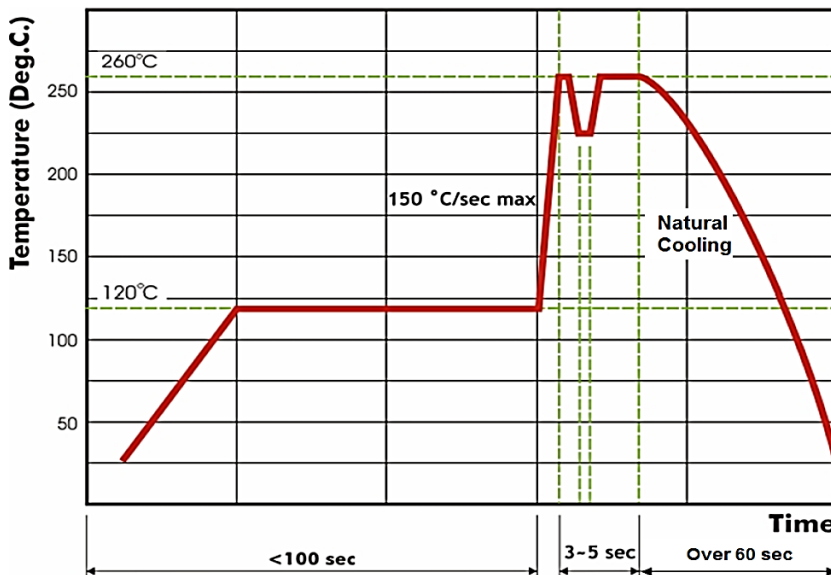

Wave Soldering Profile For SMT Process with SnAgCu series Solder Paste

MULTILAYER CERAMIC CHIP CAPACITORS 0805 SERIES

REEL DIMENSION (Unit: mm)

7": 3,000Ppcs/Reel

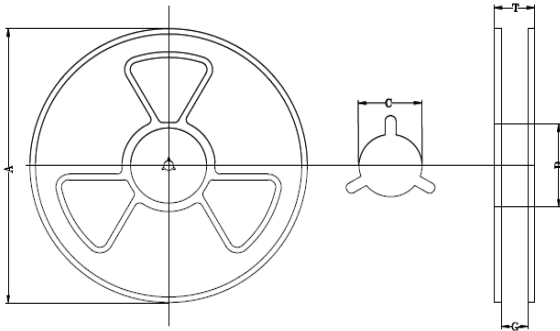

Code	Dimension 7"	Dimension 10"	Dimension 13"
A	178.0+/-0.1	250.0+/-1.0	330.0+/-1.0
B	60.0 Min.	100.0 Min.	100.0 Min.
C	13.0+/-0.50	13.0+/-0.50	13.0+/-0.50
G	8.4+/-1.0	8.4+/-1.0	8.4+/-1.0

TAPE DIMENSION (Unit: mm)

Plastic Tape

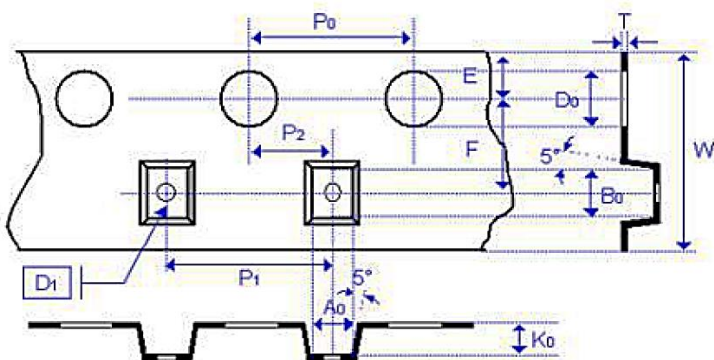

Code	Dimension
A 0	1.80 Max.
B 0	2.70 Max.
T	0.23+/-0.10
K 0	2.50 Max.
W	8.00+/-0.30
P 0	4.00+/-0.10
10xP 0	40.0+/-0.20
P 1	4.00+/-0.10
P 2	2.00+/-0.05
D 0	1.50+/-0.10
D 1	1.00+/-0.10
E	1.75+/-0.10
F	3.50+/-0.05

DISCLAIMER

NextGen Component, Inc. reserves the right to make changes to the product(s) and or information contained herein without notice. No liability is assumed as a result of their use or application. No rights under any patent accompany the sale of any such product(s) or information