

THIS DOCUMENT IS THE PROPERTY OF  
KEYSTONE ELECTRONICS CORP. AND  
SHALL NOT BE REPRODUCED, DISTRIBUTED  
OR USED AS A BASIS FOR MANUFACTURE  
WITHOUT PRIOR WRITTEN PERMISSION  
FROM KEYSTONE ELECTRONICS CORP.

ACTUAL SIZE

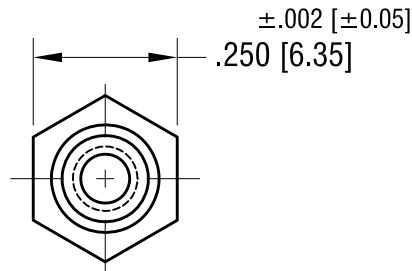

P/N 1627-2

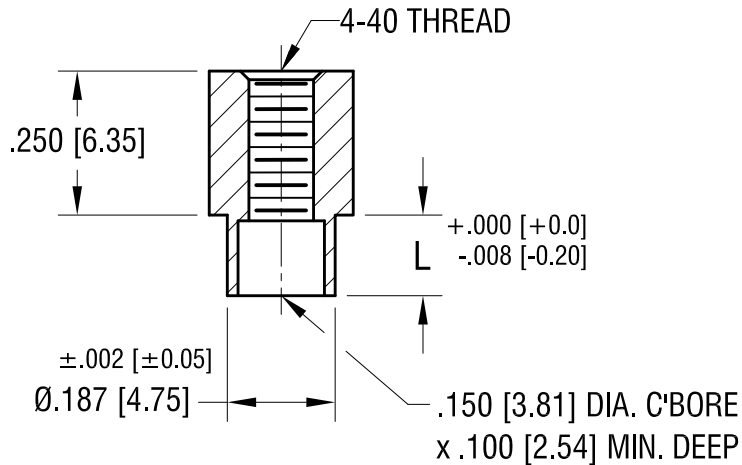

PART NO.	'L' DIM.
1627-2	.109 [2.77]
1627-3	.140 [3.56]

**KEYSTONE ELECTRONICS CORP.**

www.keyelco.com • NEW HYDE PARK NY 11040 • Tel (516)328-7500

PART NAME

SWAGE THREADED STANDOFF

MATERIAL

BRASS

FINISH DUCTILE  
NICKEL PLATE

DRN BY BOONE

DATE 5.13.02

APP'D LN

SCALE 3X

11.22.21 CHANGE AS PER ECN 21-155

A

TOLERANCES INCH [MM]  
DECIMAL ± .005 [± 0.13 ]  
ANGULAR ± 1°  
UNLESS OTHERWISE SPECIFIED

CODE DWG NO.

C

1627-

DATE DESCRIPTION

REV.