

## Table of Content

<p><b>Chapter1 Induction</b> .....2</p> <p>    1.1 General Description .....2</p> <p>    1.2 AP3917D Key Features .....2</p> <p>    1.3 Applications .....2</p> <p>    1.4 Board Picture .....2</p> <p><b>Chapter2 Power Supply Specification</b>.....3</p> <p>    2.1 system performance .....3</p> <p>    2.2 Environment.....3</p> <p><b>Chapter3 Schematic and bill of material</b> .....4</p> <p>    3.1 Schematic .....4</p> <p>    3.2 Bill of Material.....4</p> <p>    3.3 Transformer Specification.....5</p> <p>        3.3.1 Electrical Diagram.....5</p> <p>        3.3.2 Transformer Instructions .....5</p> <p>        3.3.3 Electrical Specifications .....5</p> <p><b>Chapter4 Evaluation Board Connections</b> .....5</p> <p>    4.1 PCB Layout.....5</p> <p>        4.2 Circuit Description .....5</p> <p>            4.2.1 Input EMI Filtering .....5</p> <p>            4.2.2 Control IC.....6</p> <p>            4.2.3 Buck block .....6</p>	<p>        4.2.4 Flyback block .....6</p> <p>        4.2.5 Output Rectification .....6</p> <p>        4.2.6 Output Feedback .....6</p> <p>    4.3 Quick Start Guide .....6</p> <p><b>Chapter 5 System test Data</b>.....7</p> <p>    5.1 Input &amp; Output Characteristics .....7</p> <p>        5.1.1 Input Standby Power .....7</p> <p>        5.1.2 Efficiency .....7</p> <p>        5.1.3 Line Regulation.....10</p> <p>        5.1.4 load regulation of 18V output terminal ..... 11</p> <p>    5.2 Key Performance test ..... 12</p> <p>        5.2.1 start up performance..... 12</p> <p>        5.2.3 Voltage Stress ..... 13</p> <p>        5.2.4 Output Ripple &amp; Noise..... 14</p> <p>        5.2.5 Dynamic Response..... 15</p> <p>    5.3 Protection test ..... 16</p> <p>        5.3.1 Short Circuit Protection (SCP) Test ..... 16</p> <p>        5.3.2 Over Load Protection (OLP) test ..... 17</p> <p>    5.4 Thermal Test ..... 18</p> <p>    5.5 System EMI Scan..... 19</p> <p>        5.5.1 Conduction EMI test of 230V@full load .... 19</p> <p>        5.5.2 Conduction EMI test of 110V@full load .... 20</p> <p><b>Chapter6 Revision Control History</b>.....20</p>
--	--

## Chapter1 Induction

### 1.1 General Description

AP3917D is an off-line universal AC Voltage input step-down regulator that provides accurate constant voltage (CV), outstanding low standby power, light loading efficiency and dynamics performance. The chip supports non-isolated buck and buck-boost topology, and also isolated flyback topology. The main applications are for cost-effective home appliance power.

Working with a single winding inductor and integrating a 700V MOSFET when used in buck topology, the BOM cost is very low.

The AP3917D EV2 Evaluation Board contains two outputs specifications: 18V250mA and 5V50mA, with both non-isolations. The 18V250mA is buck topology and the other is flyback. The two topologies share a two-winding transformer. The feedback circuitry samples 18V output. The user's guide provides good design example for dual output power applications in home appliance power.

### 1.2 AP3917D Key Features

- Universal 85V to 264V  $V_{AC}$  Input
- Internal MOSFET 700V ( $R_{ds(on)}$  10 $\Omega$  max. @25 $^{\circ}$ C)
- Maximum output Current: 370mA typ.@5V output
- Low Standby Power Consumption
- High Light Loading Efficiency and average efficiency can meet DOE IV and CoC V5 Tier 2
- Frequency Modulation to suppress EMI to meet EN55032 and FCC part 15 class B
- Rich Protection including: OTP, OLP, OLD,SCP
- Extremely low system component count.
- Totally Lead-free & Fully RoHS Compliant (SO-7)
- Halogen and Antimony Free. "Green" Device

### 1.3 Applications

- Non-Isolated Home Appliances including: AC Fans, Rice Cooker, Air conditioner, Coffee Machines, Soy Milk Machines, etc.
- Auxiliary Power to IoT Devices.

### 1.4 Board Picture

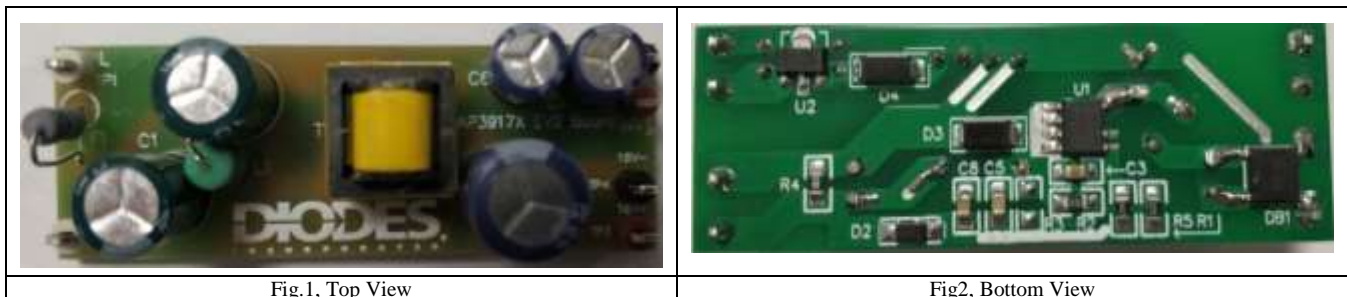

## Chapter2 Power Supply Specification

### 2.1 system performance

The system performance included in and output characters, specifications, EMC, protection, etc.

Items	Min.	Typ.	Max.	Comments
<b>input characters</b>				
Input AC voltage rating	100V/60Hz	115/230	240V/50Hz	Two wire, no PE
Input AC voltage range	85V/60Hz	-	264V/50Hz	
Input AC frequency range	47Hz	50/60	63Hz	
<b>Output characters</b>				
Output voltage 1	17.1V	18.0V	18.9V	Test at board terminal
Output voltage 1	4.75V	5.0V	5.25V	
loading current 1	0	-	250mA	mA
loading current 2	0	-	50mA	
<b>performance specifications</b>				
Standby power	-		100mW	@230V/50Hz
Efficiency	-	78.04%/77.60%	-	@full load, 115V/230V
Ripple & Noise	18V	-	141mV	@full load
	5V	-	38mV	
Start up time	-	58.4ms	100ms	@full load, 85V/60Hz
<b>EMC test</b>				
ESD test	Air	15kV	-	@full load condition
	contract	8kV	-	
EFT test		4kV	-	±5kHz/100kHz
Surge Test		1kV	-	Differential mode, 2ohm, 1.2/50us
Conduction EMI	110V	6dB margin	-	FCC Part 15 Class B
	230V	6dB margin	-	EN55032
<b>Protection function</b>				
SCP test	-	-	-	OK
OLP test	-	-	-	OK
OTP test	135°C	150°C	165°C	OK

### 2.2 Environment

Operation temperature: -20°C~85°C

Operation Humidity: 20%~90% R.H.

Storage temperature: 0~40°C

Storage Humidity: 0%~95% R.H.

### Chapter3 Schematic and bill of material

#### 3.1 Schematic

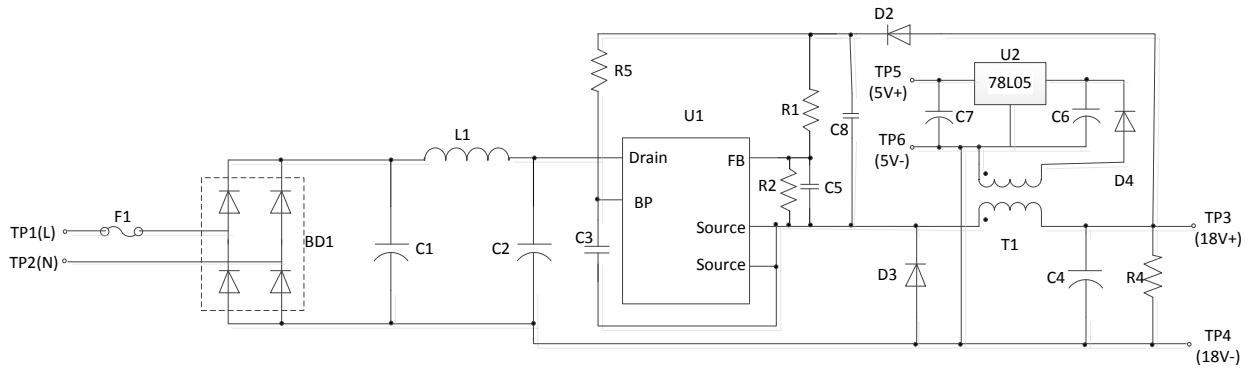

Fig. 3, Evaluation Board Schematic

#### 3.2 Bill of Material

Table 1, bill of material

Item	Designator	Description	Footprint	Qty.	Manufacturer
1	F1	10R, fusible resistor	Φ3*10mm	1	OAHE
2	DB1	ABS10A, bridge diode	SOPA-4	1	Diodes
3	C1, C2	4.7uF/400V, electrolytic capacitor	Φ6*9mm	2	Aishi
4	C3	2.2uF/25V, X7R	SMD 0805	1	Telesky
5	C4	470uF/25V, electrolytic capacitor	Φ6*11mm	1	Aishi
6	C5	1nF/50V, X7R	SMD 0805	1	Telesky
7	C6, C7	100uF/25V, electrolytic capacitor	Φ6*8mm	2	Telesky
8	C8	330nF/50V, X7R	SMD 0805	1	Telesky
9	D2	S1MWF-7, slow type diode, mark F9	SOD123-FL	1	Diodes
10	D3, D4	ES1J, Trr < 50ns	SMA	2	Diodes
11	L1	1mH,color ring inductor	DIP, 0510	1	Deloop
12	T1	EE10, Horizontal	DIP, 4+4Pin	1	Deloop
13	R1	22.1k, thick film	SMD 0805, 1%	1	Panasonic
15	R2	3.57k, thick film	SMD 0805, 1%	1	Panasonic
15	R4	22k, thick film	SMD 0805, 5%	1	Panasonic
16	R5	51k, thick film	SMD 0805, 5%	1	Panasonic
17	U1	AP3917D	SO-7	1	Diodes
18	U2	AS78L05	SOT-89	1	Diodes
Total		20pcs			

### 3.3 Transformer Specification

#### 3.3.1 Electrical Diagram

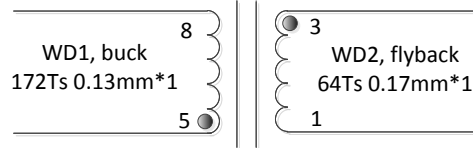

Fig. 4, transformer electrical diagram

#### 3.3.2 Transformer Instructions

Winding	Wire	Turns	Notes
5-8	0.13mm*1 UEW	172	Four layer with tight tension
Tape	W=7mm	2	Full layer
3-1	0.17mm*1 UEW	64	Two layer with tight tension
Tape	W=7mm	2	Full layer

Note: the transformer need be varnished. Put the transformer in the varnish for 30min, then remove it to the oven at 90°C for at least 6 hours.

#### 3.3.3 Electrical Specifications

Item	Pins	Inductance	Conditions
Main inductance	5-8	1.05mH ± 7%	1/3pin open, 1V/10kHz
Leak inductance	5-8	<70uH	1/3pin short, 1V/10kHz

## Chapter4 Evaluation Board Connections

### 4.1 PCB Layout

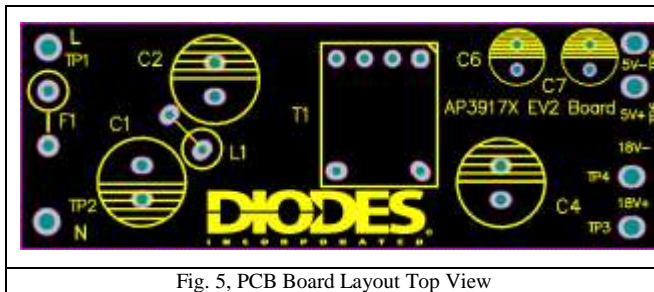

Fig. 5, PCB Board Layout Top View

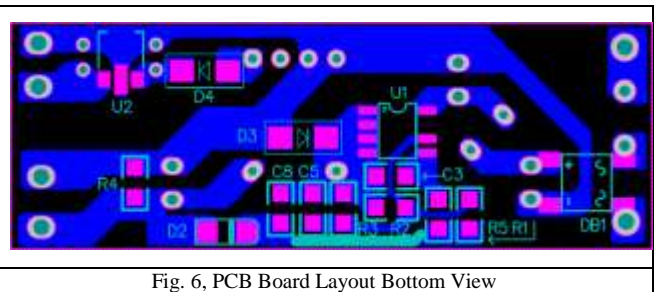

Fig. 6, PCB Board Layout Bottom View

## 4.2 Circuit Description

### 4.2.1 Input EMI Filtering

The input stage is composed of fusible resistor F1, bridge diodes (DB1), L1, Capacitors C1 and C2, and inductor L1. Resistor F1 is a flame proof, fusible, wire-wound resistor. It limits inrush current to safe levels for bridge diodes, provides differential mode noise reduction and acts as an input fuse in the event of short circuit.

### 4.2.2 Control IC

AP3917D co-packages a 700V power MOSFET and control circuitry into a cost-effective SO-8 package. The device gets its start-up current from DRAIN pin with a small capacitor C3 connect to VCC pin when AC source is applied.

### 4.2.3 Buck block

The buck block is almost the same as the single output buck system. During the Mosfet turn ON time, the power was sent to output terminal via transformer main windings from input PI filter block directly. When the Mosfet turn OFF, the transformer is act as a constant voltage source, the energy stored in the transformer was sent to the output through the freewheeling diode D3.

### 4.2.4 Flyback block

The flyback and buck system which are coupled in a transformer is usually be called Fly-buck system. The transformer have two windings, the pin connected to output capacitor of buck section and the pin connected to diode D4's anode of flyback section are dotted terminals. When the Mosfet turns on, the flyback diode D4 does not conduct; while the Mosfet turns off, the diode conduct, then the energy stored in the transformer can be sent to 5V output terminal. U2 is a common LDO, 78L05, which can achieve excellent output characters by using it after the flyback output capacitor C6.

### 4.2.5 Output Rectification

During the ON time of U1, current ramps in the main inductance of transformer T1 until the current reaches to the  $I_{PK\_MAX}$ . During the OFF time the inductor current ramps down via free-wheeling diodes D3 and flyback diode D4. D3 and D4 should be ultra-fast diode ( $T_{rr} < 50ns$  or lower). Capacitor C6 should be selected to have an adequate ripple margin.

### 4.2.6 Output Feedback

The voltage across main winding of transformer is rectified by D2 and C8 during the off-time of U1. For forward voltage drop of D3 and D2 is approximately equal, the voltage across C5 track the output voltage. The voltage across C5 is divided by R1 and R2. This voltage is specified for FB (2.5V). This allows the simple feedback to meet the required overall output tolerance of  $\pm 5\%$  at rated output current.

## 4.3 Quick Start Guide

1. The evaluation board is preset at 18V/250mA+5V50mA from output.
2. Ensure that the AC source is switched OFF or disconnected before doing connection.
3. Connect the AC line wires of power supply to "L and N" on the left side of the board.
4. Turn on the AC main switch.
5. Measure output terminals to ensure correct output voltages of Vo1 and Vo2 respectively.

**CAUTION:** This EV board is non-isolated. Do not touch anywhere there are electrical connections because they are all coupled to high voltage potential.

## Chapter5. System test Data

### 5.1 Input & Output Characteristics

#### 5.1.1 Input Standby Power

The standby power and output voltage was tested after 10min burning. The voltage data was tested at the PCB terminal. All the data was tested at room temperature.

Table 2, standby power and no load output voltage

Input Voltage	Pin (mW)	Vo1 (V)	Vo2 (V)
85V/60Hz	55.7	18.132	5.040
115V/60Hz	56.9	18.109	5.039
230V/50Hz	72.4	18.136	5.041
264V/50Hz	82.6	18.088	5.041

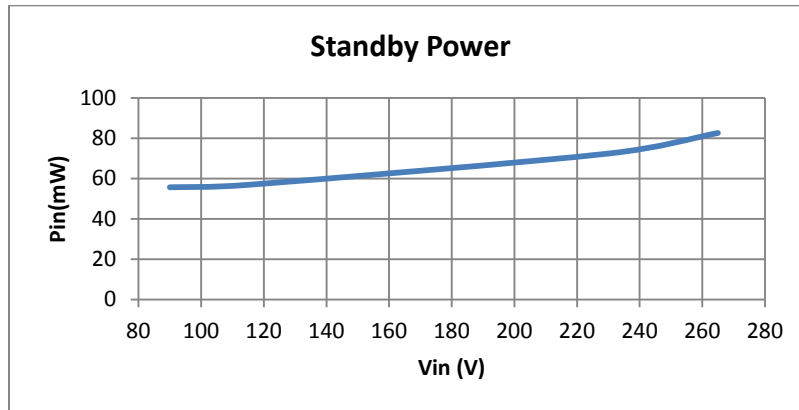

Fig. 7, Standby Power versus Vin Curve

#### 5.1.2 Efficiency

The efficiency data was tested after 10min burning, and it was tested at the PCB terminal. All the data was tested at room temperature.

##### 5.1.2.1 18V and 5V full load vs Vin.

18V and 5V full load, input voltage range from 85V/60Hz to 265V/50Hz.

Table 3, Full load efficiency VS Vin data

Vin	Vo1(V)	Vo2(V)	Pin(W)	Eff.
85V/60Hz	17.884	5.036	6.205	76.11%
115V/60Hz	17.870	5.036	6.047	78.04%
150V/60Hz	17.870	5.035	6.004	78.60%
180V/50Hz	17.851	5.035	6.010	78.44%
200V/50Hz	17.841	5.035	6.026	78.19%
230V/50Hz	17.816	5.035	6.064	77.60%
265V/50Hz	17.792	5.035	6.114	76.87%

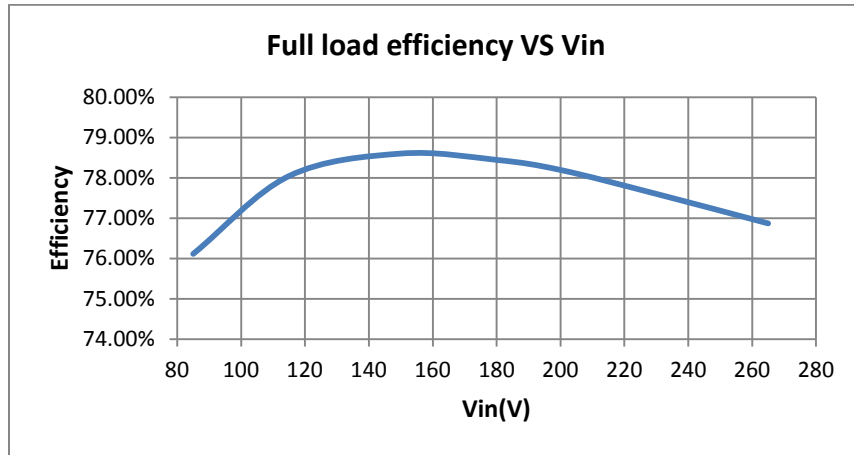

Fig. 8, Full load efficiency VS Vin

**5.1.2.2 5V no load, 18V load ranges**

5V no load, the 18V load ranges from 10% to 100%.

Table 4, efficiency VS Loading@5V no load

Vin	10%	25%	50%	75%	100%	Ave. eff.
85V/60Hz	78.01%	80.86%	80.59%	79.82%	77.79%	79.76%
115V/60Hz	77.97%	82.33%	81.88%	82.04%	80.41%	81.67%
230V/50Hz	75.81%	80.34%	81.85%	81.99%	79.72%	80.97%
265V/50Hz	74.61%	79.56%	81.18%	81.57%	79.18%	80.37%

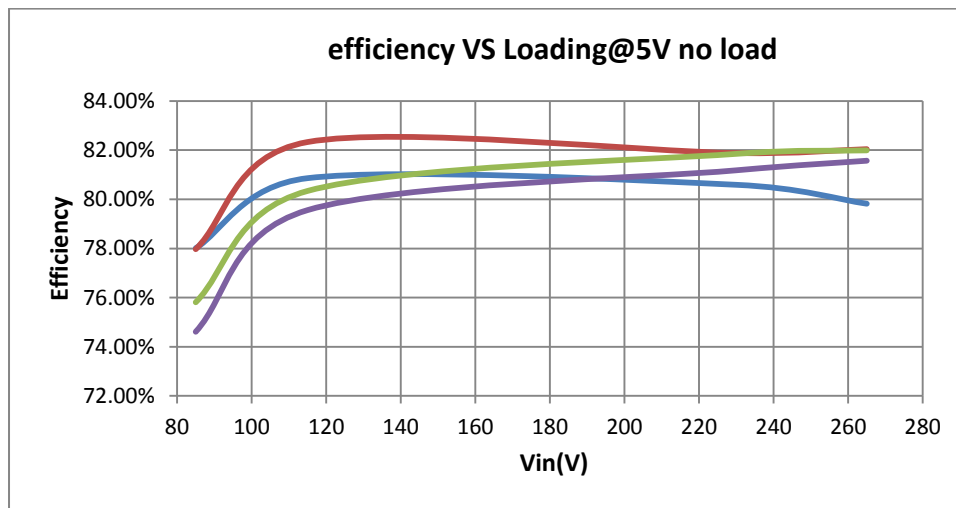

Fig 9, efficiency VS Loading@5V no load



**5.1.2.3 5V full load, 18V load ranges.**

5V full load, the 18V load range from 10% to 100%.

Table 5, efficiency VS Loading@5V full load

Vin(V)	10%	25%	50%	75%	100%	Ave. Eff.
85V/60Hz	69.97%	76.61%	78.46%	78.32%	74.83%	77.06%
115V/60Hz	70.51%	77.49%	79.82%	80.07%	78.06%	78.86%
230V/50Hz	69.36%	72.76%	79.90%	80.82%	78.16%	77.91%
265V/50Hz	68.61%	76.40%	79.63%	80.52%	77.46%	78.50%

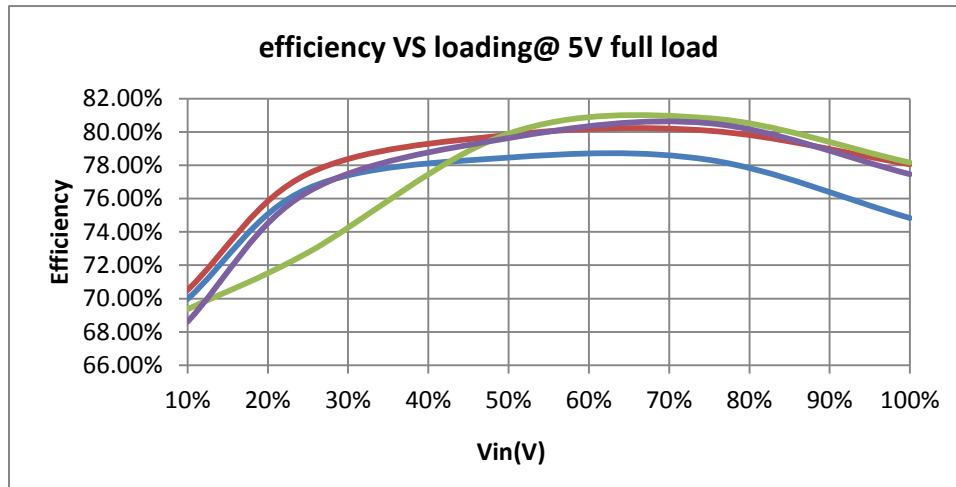

Fig 10, efficiency VS Loading@5V full load

**5.1.3 Line Regulation**

The line regulation data was tested after 10min burning. The voltage data was tested at the PCB terminal. All the data was tested at room temperature.

**5.1.3.1 5V no load, 18V full load vs Vin**

Table 6, line and load regulation data

Vin	Vo1 output(V)	Vo2 output (V)
85V/60Hz	17.880	5.040
115V/60Hz	17.860	5.040
230V/50Hz	17.843	5.040
265V/50Hz	17.684	5.040

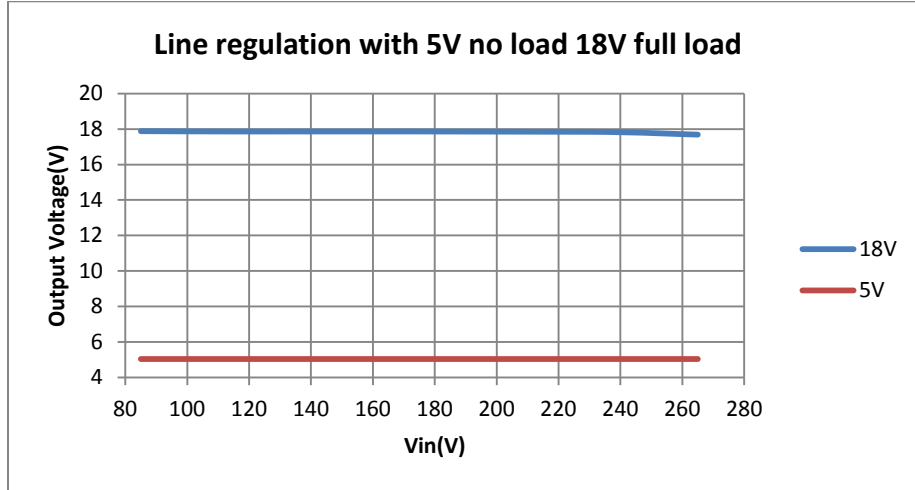

Fig 11, 5V no load, 18V full load, output voltage versus input voltage

**5.1.3.2 5V and 18V full load vs Vin**

Table 7, 5V and 18V full load vs Vin

Vin	Vo1 output(V)	Vo2 output(V)
85V/60Hz	17.846	5.031
115V/60Hz	17.841	5.030
230V/50Hz	17.830	5.030
265V/50Hz	17.816	5.030

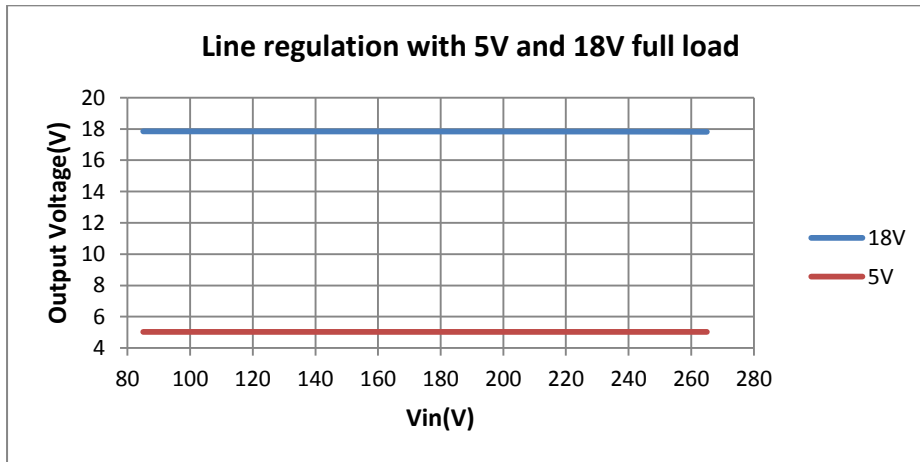

Fig. 12, 5V and 18V full load vs Vin

### 5.1.4 load regulation of 18V output terminal

The load regulation data was tested after 10min burning. The voltage data was tested at the PCB terminal. All the data was tested at room temperature.

#### 5.1.4.1 5V no load, 18V load ranges.

The load of Vo1 terminal ranges from 10% to 100%.

Table 8, 18V and 5V output voltage@ 5V no load

Vin	10%		25%		50%		75%		100%	
	Vo1(V)	Vo2(V)	Vo1(V)	Vo2(V)	Vo1(V)	Vo2(V)	Vo1(V)	Vo2(V)	Vo1(V)	Vo2(V)
85V/60Hz	18.112	5.039	18.024	5.039	17.944	5.040	17.904	5.040	17.875	5.040
115V/60Hz	18.092	5.040	18.013	5.040	17.931	5.040	17.910	5.040	17.892	5.040
230V/50Hz	17.640	5.040	17.584	5.040	17.916	5.040	17.896	5.040	17.92	5.040
265V/50Hz	17.582	5.040	17.523	5.040	17.902	5.040	17.881	5.040	17.879	5.040

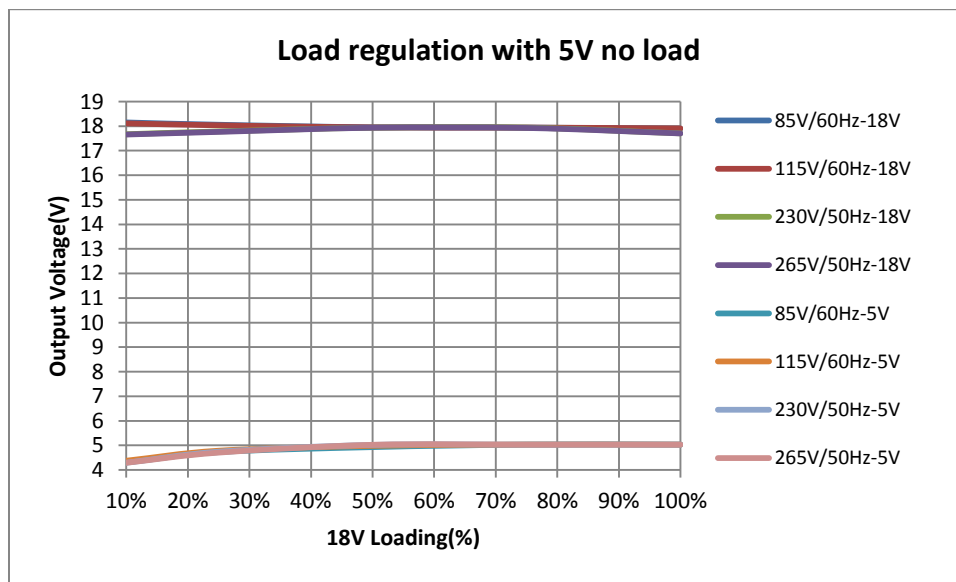

Fig. 13, 18V and 5V output voltage@ 5V no load

#### 5.1.4.2 5V full load, 18V load ranges.

The load of Vo1 terminal ranges from 10% to 100%.

Table 9, 18V and 5V output voltage@ 5V full load

Vin	10%		25%		50%		75%		100%	
	Vo1(V)	Vo2(V)	Vo1(V)	Vo2(V)	Vo1(V)	Vo2(V)	Vo1(V)	Vo2(V)	Vo1(V)	Vo2(V)
85V	18.148	4.308	18.054	4.726	17.951	4.930	17.939	5.032	17.894	5.032
115V	18.111	4.376	18.03	4.784	17.946	4.982	17.940	5.032	17.905	5.031
230V	17.668	4.293	17.782	4.743	17.933	5.020	17.936	5.031	17.704	5.031
265V	17.656	4.292	17.763	4.706	17.932	5.024	17.923	5.031	17.700	5.031

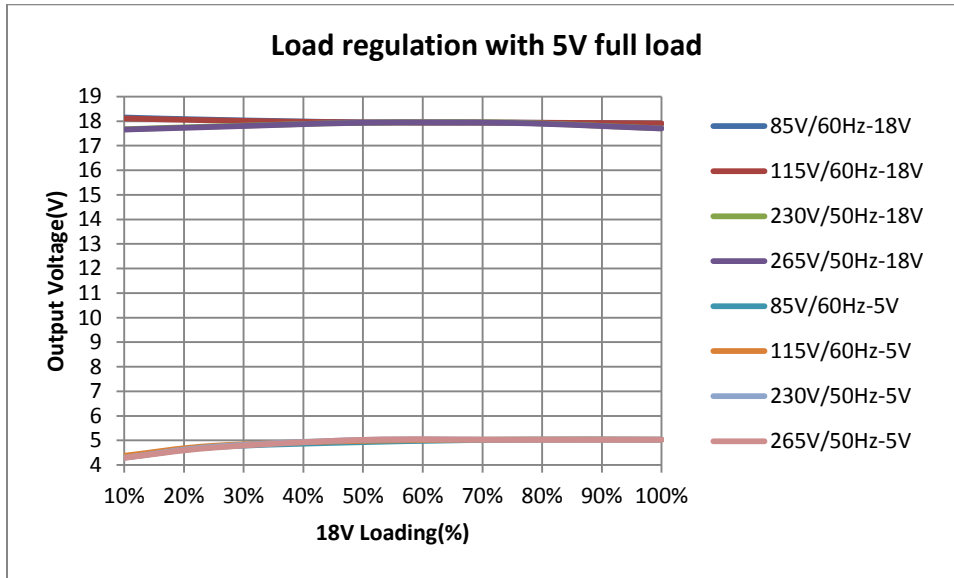

Fig. 14, 18V and 5V output voltage@ 5V full load

## 5.2 Key Performance test

### 5.2.1 start up performance

The start-up time was measured with differential probe clipping on the input AC source TP1 and TP2, and the common low-voltage probe clipping on the output terminal TP3~TP6. Before start-up, the buck should be discharged.

Table 10, start up performance

Input voltage	Start up time	figures
85V/60Hz	58.4ms	Fig. 15
115V/50Hz	57.3ms	Fig. 16
230V/50Hz	39.6ms	Fig. 17
264V/60Hz	39.0ms	Fig. 18

CH1:Vin; CH2:5V output; CH4:18V output

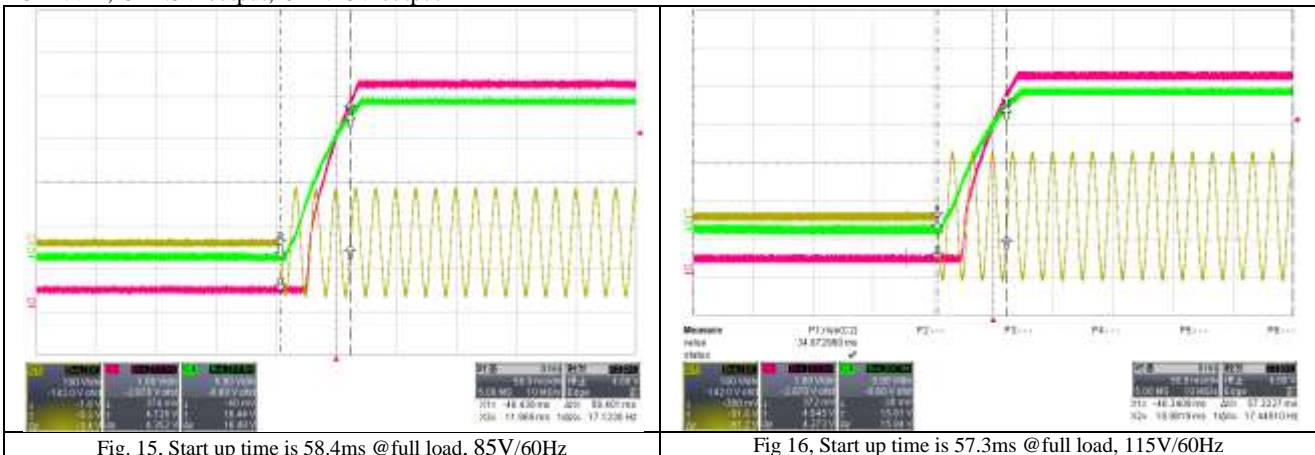

Fig. 15, Start up time is 58.4ms @full load, 85V/60Hz

Fig. 16, Start up time is 57.3ms @full load, 115V/60Hz

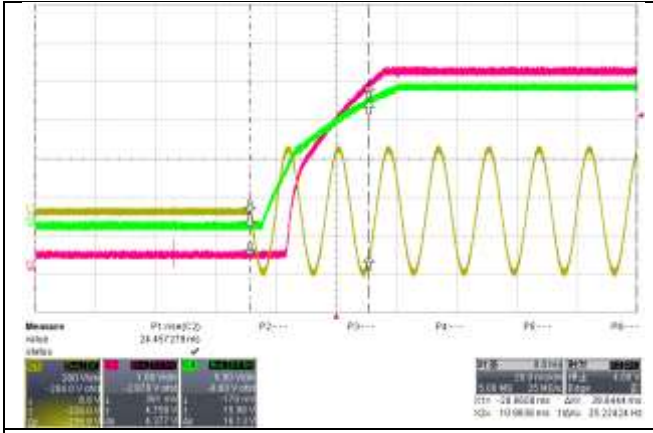

Fig. 17, Start up time is 39.6ms @full load, 230V/50Hz

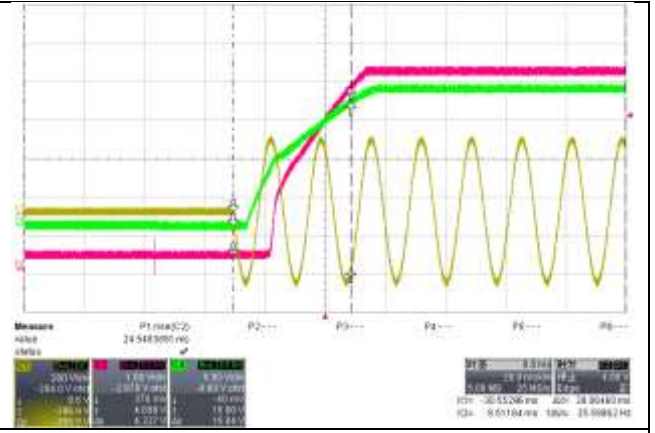

Fig 18, Start up time is 39.0ms @full load, 265V/50Hz

### 5.2.3 Voltage Stress

The voltage tested below was between the source and the drain pin of IC. The test need use differential probe. The Vak voltage is tested between the anode and cathode of flyback diode D4.

Table 11, MOSFET drain-source and flyback diodes Vak voltage stress

Input voltage	Voltage stress		figures
	Vds(V)	Vak(V)	
85V/60Hz	140	61	Fig. 19
115V/50Hz	187	86	Fig. 20
230V/50Hz	351	179	Fig. 21
264V/60Hz	399	206	Fig. 22

CH1:Vds; CH2:Vak

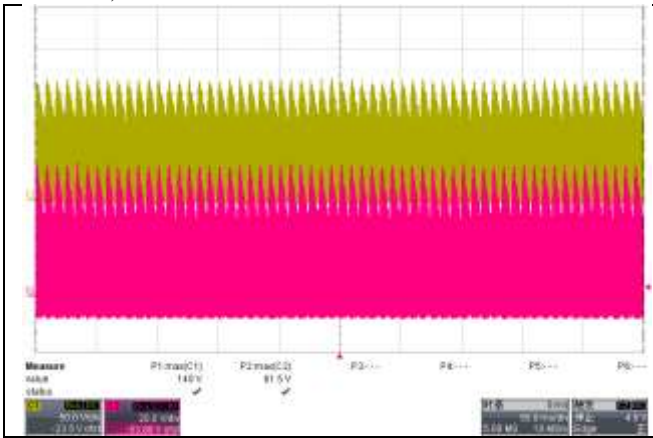

Fig. 19, MOS drain-source 140V, Vak 61V@85V/60Hz, full load

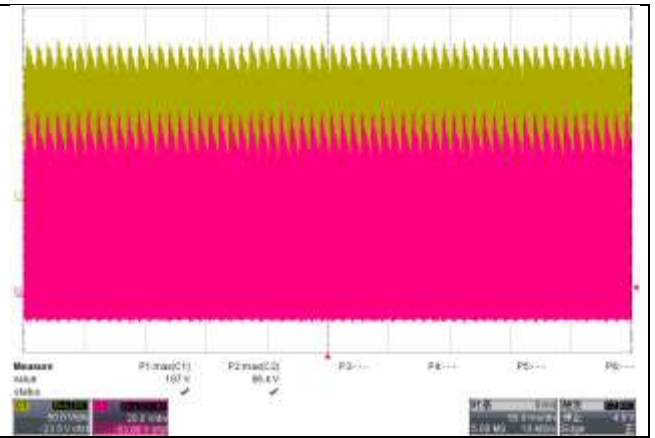

Fig. 20, MOS drain-source 187V, Vak 86V@115V/60Hz, full load

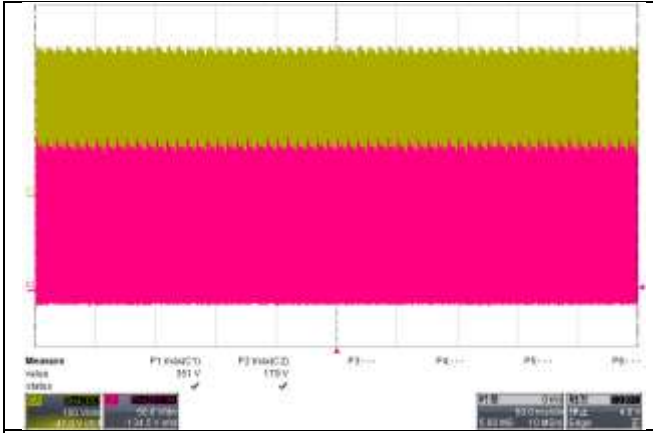

Fig. 21, MOS drain-source 351V, Vak 179V@230V/50Hz, full load

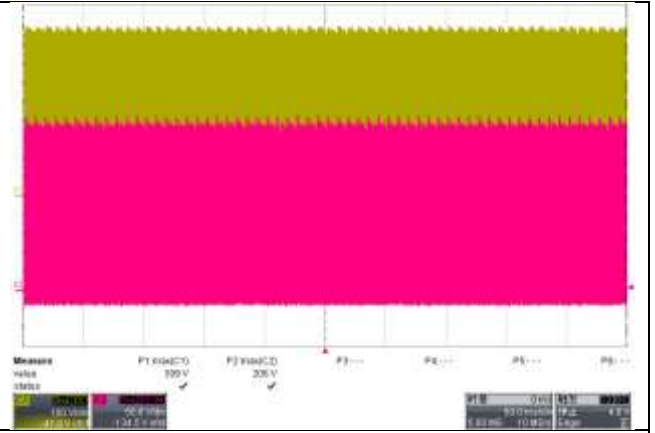

Fig. 22, MOS drain-source 399V, Vak 206V@264V/50Hz, full load

### 5.2.4 Output Ripple & Noise

The ripple and noise was tested at PCB terminal, using coaxial cable (1:1). The bandwidth was limited to 20MHz. A 10uF electrolytic capacitor and a 104 ceramic capacitor should be paralleled to the output terminal.

Table 12, ripple & noise

Conditions	Input voltage	R&N(mV)		Figures
		Vo1 terminal	Vo2 terminal	
5V full load, 18V full load	85V/60Hz	141	38	Fig. 23
	115V/50Hz	123	30	-
	230V/50Hz	88	29	-
	264V/60Hz	75	30	Fig. 24
5V no load, 18V full load	85V/60Hz	139	26	Fig. 25
	115V/50Hz	123	35	-
	230V/50Hz	96	32	-
	264V/60Hz	77	29	Fig. 26

CH2:Vo1 output; CH1:Vo2 output

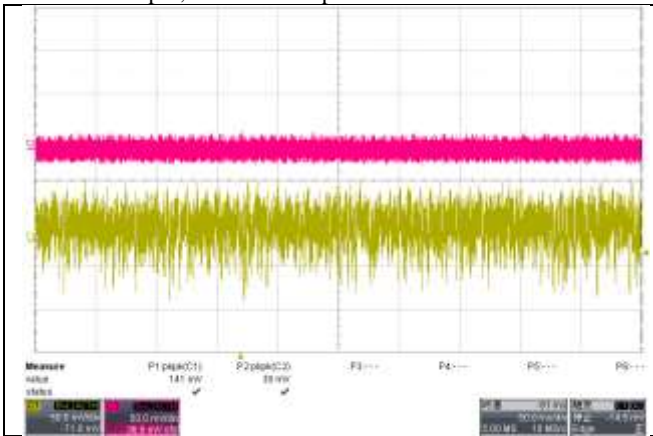

Fig.23, Output R&N 141/38mV@5V full load,18V full load, 85V/60Hz

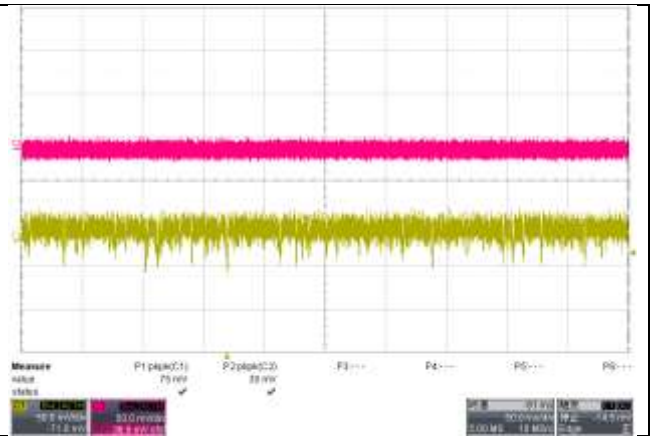

Fig.24, Output R&N 75/30mV@5V full load,18V full load, 264V/50Hz

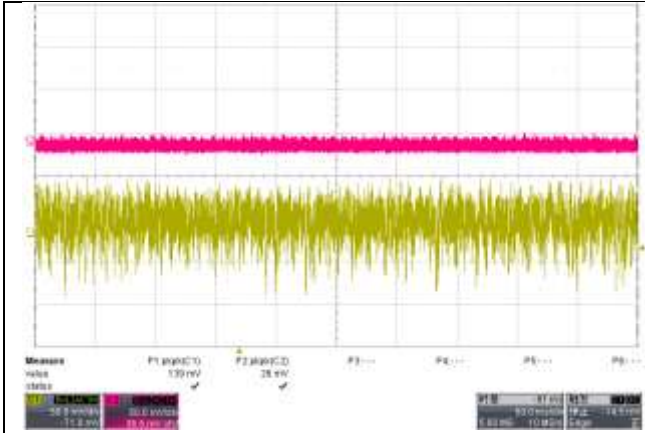

Fig.25, Output R&N 139/26mV@5V no load, 18V full load, 85V/60Hz

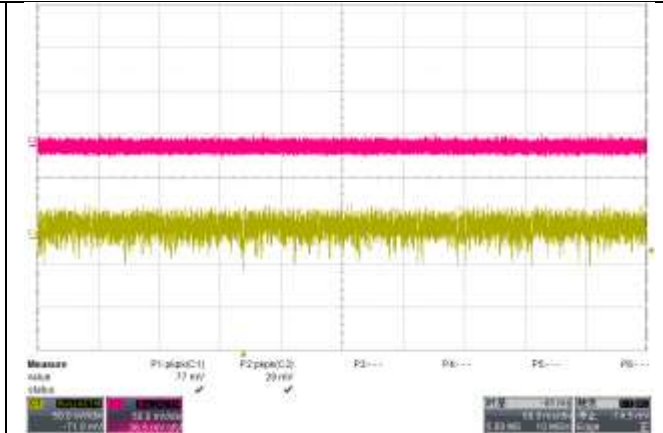

Fig.26, Output R&N 77/29mV@5V no load, 18V full load, 265V/50Hz

### 5.2.5 Dynamic Response

The dynamic response output voltage was tested at the PCB terminal, and the bandwidth was limited to 20MHz. The loading is set 125mA as low load and 250mA as high load, and last for 1s respectively. The ramp is set at 40mA/us.

Table 13, dynamic response

Conditions	Vin	Output voltage(V)				Figures
		Vo1		Vo2		
		Max (V)	Min (V)	Max (V)	Min (V)	
5V full load, 18V loading 50%~100%	85V/60Hz	18.16	17.72	5.14	5.49	Fig. 27
	115V/60Hz	18.14	17.44	5.13	4.94	-
	230V/50Hz	17.12	17.44	5.13	4.92	-
	264V/50Hz	18.11	17.41	5.14	4.86	Fig. 28
5V no load, 18V loading 50%~100%	85V/60Hz	18.14	17.72	5.14	5.01	Fig. 29
	115V/60Hz	18.13	17.69	5.14	5.01	-
	230V/50Hz	18.08	17.40	5.14	5.01	-
	264V/50Hz	18.07	17.36	5.14	5.01	Fig. 30

CH2:18V output; CH4:5V output

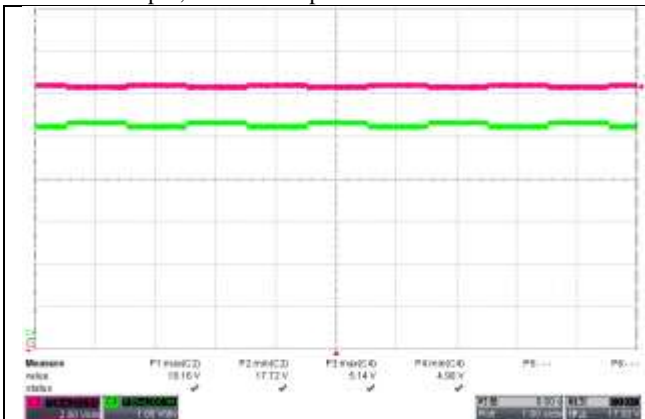

Fig.27, dynamic response@125~250mA,5V full load, 85V/60Hz

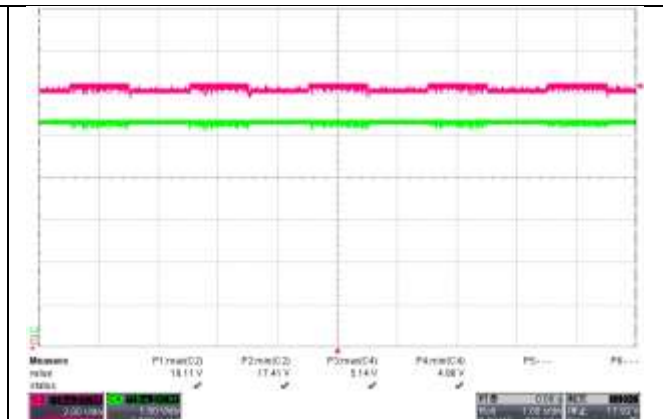

Fig. 28, dynamic response@125~250mA,5V full load, 265V/50Hz



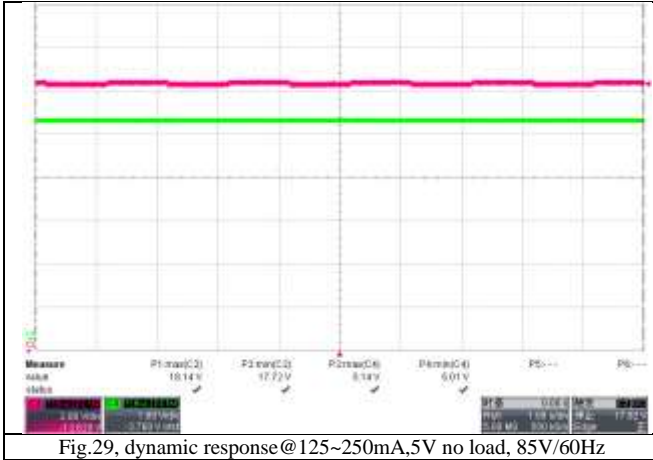

Fig.29, dynamic response@125~250mA,5V no load, 85V/60Hz

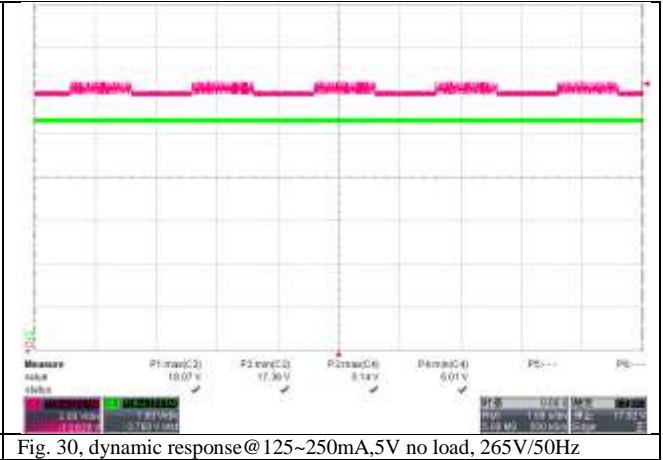

Fig. 30, dynamic response@125~250mA,5V no load, 265V/50Hz

### 5.3 Protection test

#### 5.3.1 Short Circuit Protection (SCP) Test

The SCP test was measured under the condition of output cable terminal short circuit. The resistance of output cable is 50mohm.

Table 14, the short circuit protection test

Condition	Vin	Vds(V)	Vo1 max(V)	Vo2 max(V)	Figures
5V terminal output short	85V/60Hz	144	18.21	5.15	Fig. 31
	115V/60Hz	185	18.22	5.15	-
	230V/50Hz	350	18.30	5.18	-
	264V/50Hz	413	18.33	5.21	Fig. 32
18V terminal output short	85V/60Hz	144	18.21	5.15	Fig. 33
	115V/60Hz	188	18.18	5.18	-
	230V/50Hz	348	18.20	5.24	-
	264V/50Hz	413	18.25	5.23	Fig. 34

CH1:Vds; CH2:18V output;CH4:5V output

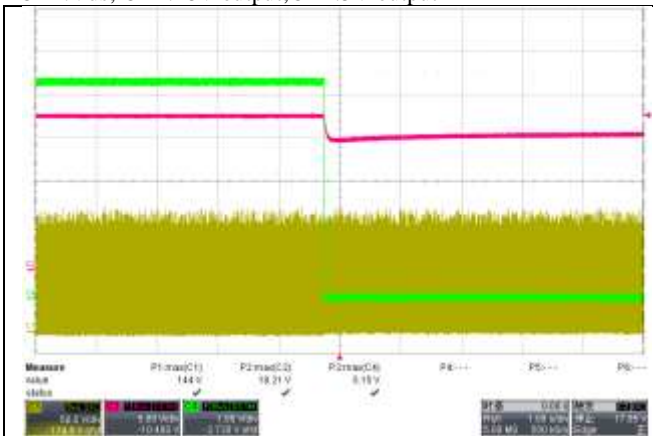

Fig. 31, SCP performance@5V output short and 18V full load, 85V/60Hz

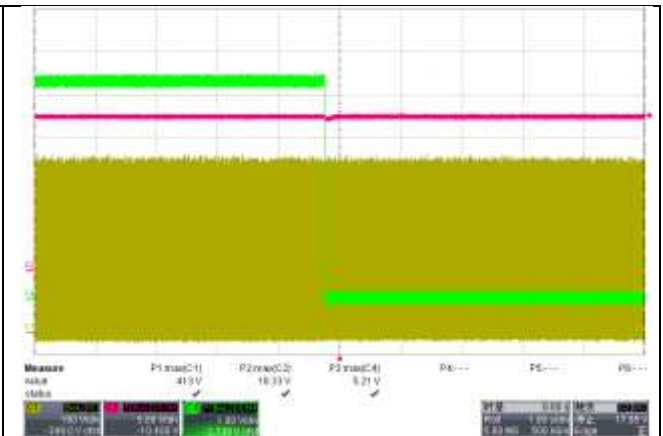

Fig. 32, SCP performance@5V output short and 18V full load, 265V/50Hz



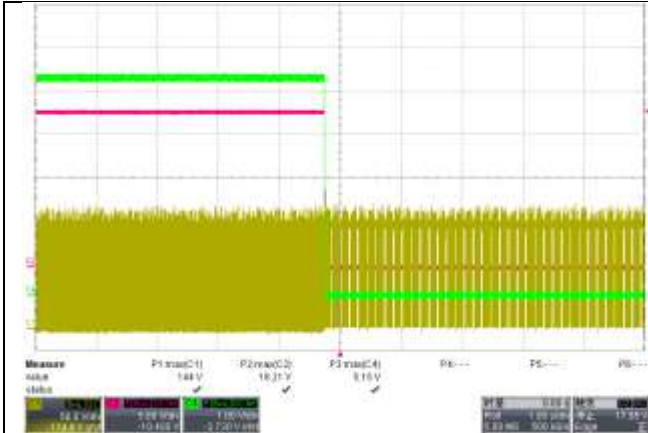

Fig. 33, SCP performance@18V output short and 5V full load, 85V/60Hz

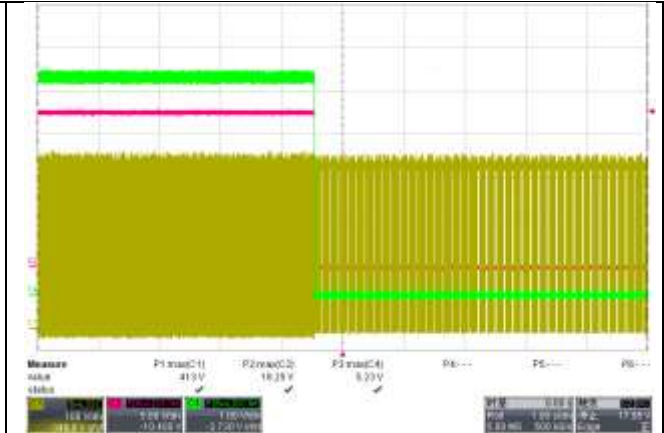

Fig. 34, SCP performance@18V output short and 5V full load, 265V/50Hz

### 5.3.2 Over Load Protection (OLP) test

The voltage data under OLP condition was tested as below: increase the loading 10mA step by step, until the system can not maintain a stable output, then observe the maximum output voltage of Vo1 and Vo2.

Table 15, the over load protection test

Conditions	Vin	Vds(V)	Output Voltage(V)	
			Vo1(V)	Vo2(V)
5V full load, increase 18V loading to OLP	85V/60Hz	144	10.00	2.55
	256V/50Hz	413	11.12	3.05
18V full load, increase 5V loading to OLP	85V/60Hz	143	15.67	0.19
	256V/50Hz	413	18.32	0.25

CH1:Vds; CH2:18V output; CH4:5V output.

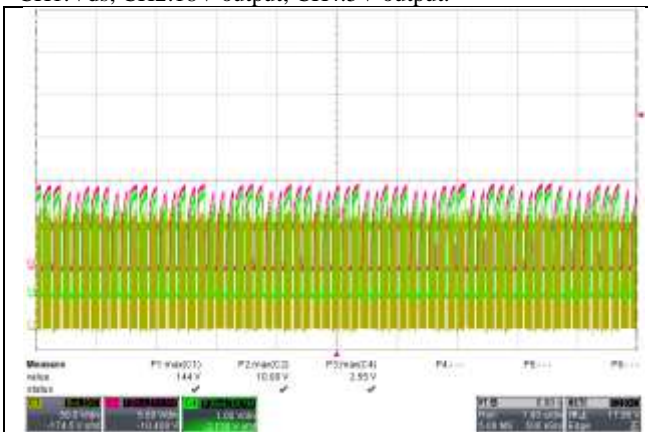

Fig. 35, SCP performance@18V output short and 5V full load, 85V/60Hz

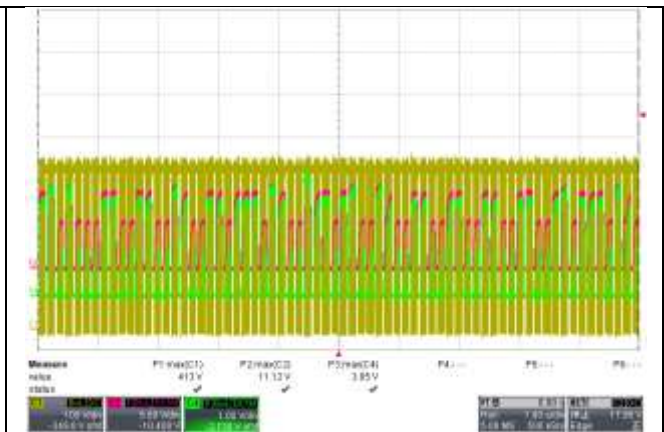

Fig. 36, SCP performance@18V output short and 5V full load, 265V/50Hz

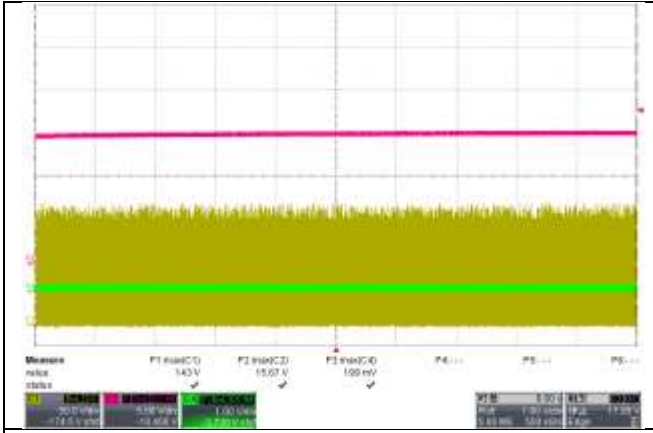

Fig. 37, SCP performance@18V output short and 5V full load, 85V/60Hz

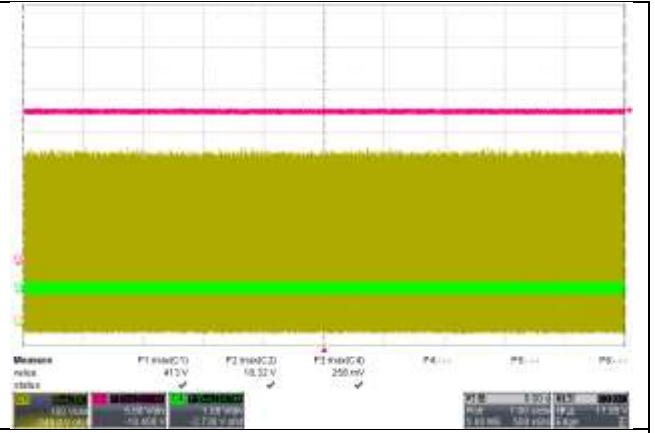

Fig. 38, SCP performance@18V output short and 5V full load, 265V/50Hz

### 5.4 Thermal Test

The thermal test was under room temperature after burning 1 hour. The board has no case, and using thermal imager to observe the surface temperature of IC.

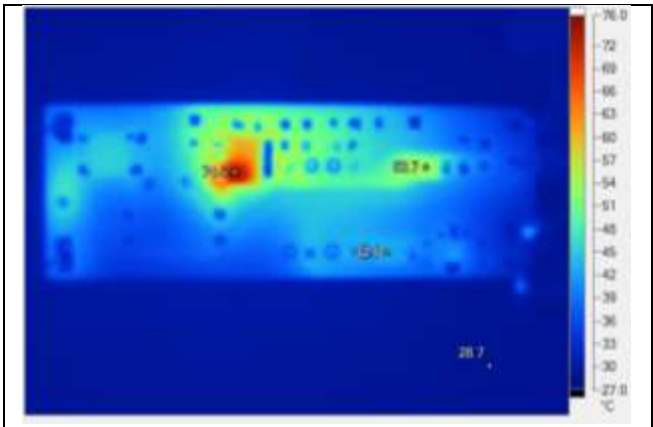

Fig. 39, IC 74.5°C, free-wheeling diode 53.7°C, flyback diode 42.5°C @full load, 85V/60Hz, ambient temperature 28.7°C.

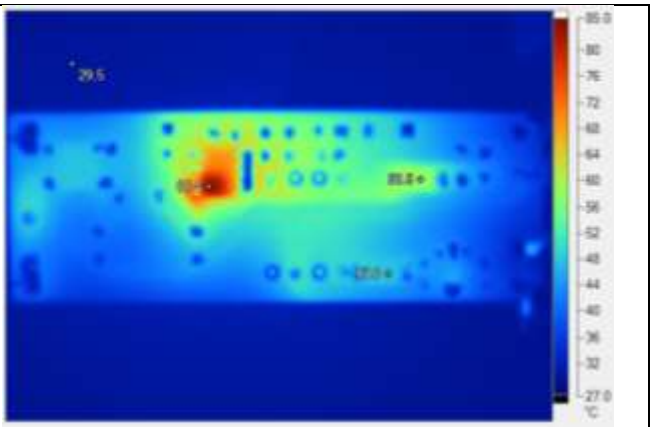

Fig. 40, IC 83.4°C, free-wheeling diode 58.5°C, flyback diode 47.6°C @full load, 264V/50Hz, ambient temperature 29.5°C.

## 5.5 System EMI Scan

The power supply passed EN55022 Class B (for 230V input) and FCC part 15 (for 110V input) EMI requirement with more than 6dB margin.

### 5.5.1 Conduction EMI test of 230V@full load

The test result can pass EN55022 Class B limitation with more than 6dB margin.

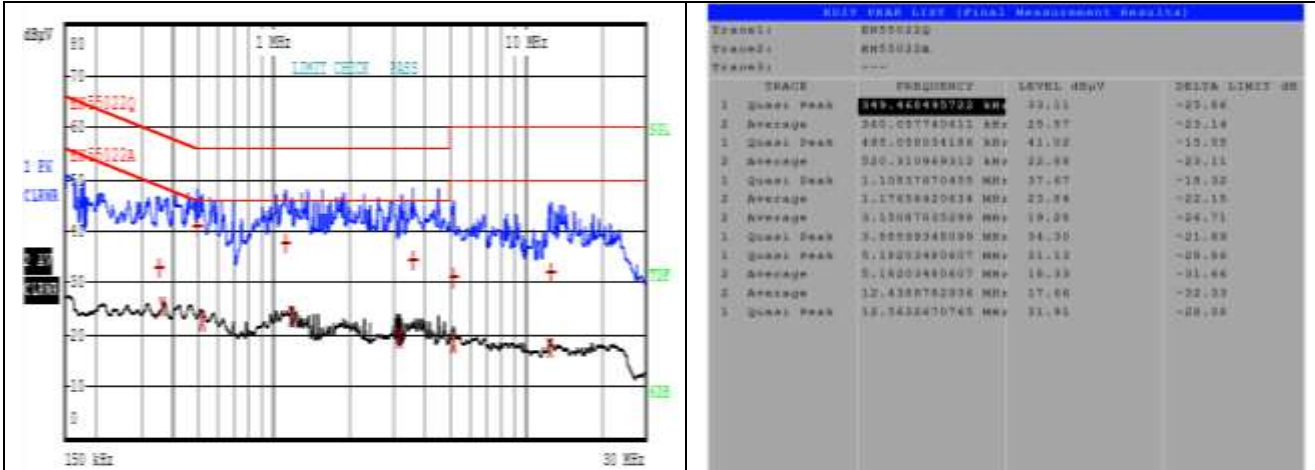

Fig. 41, L line conduction waveform@230V, full load.

Fig. 42, L line conduction data@230V, full load.

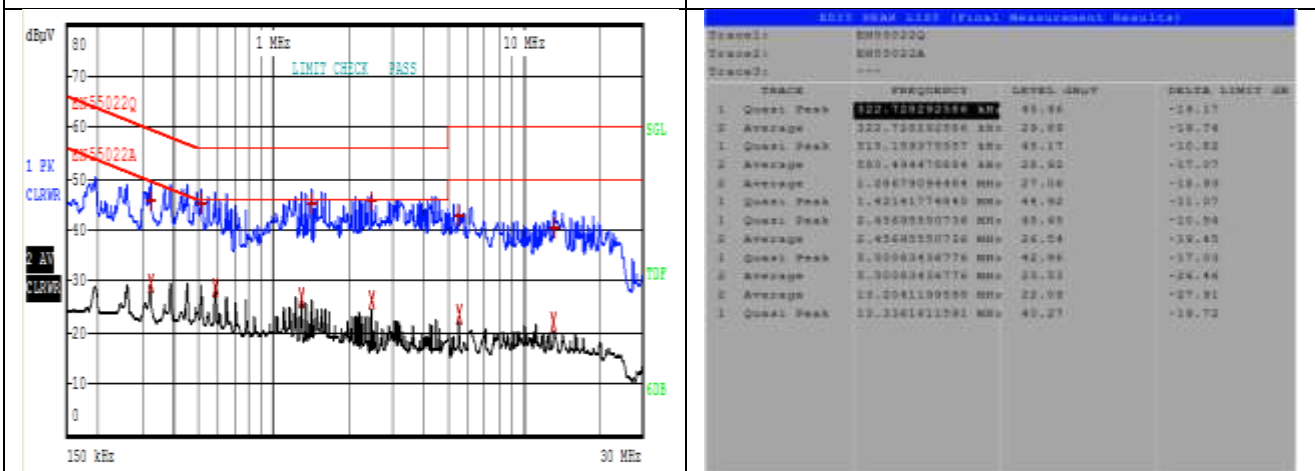

Fig. 43, N line conduction waveform@230V, full load.

Fig. 44, N line conduction data@230V, full load.

## 5.2 Conduction EMI test of 110V@full load

The test result can pass FCC part 15 limitation with more than 6dB margin.

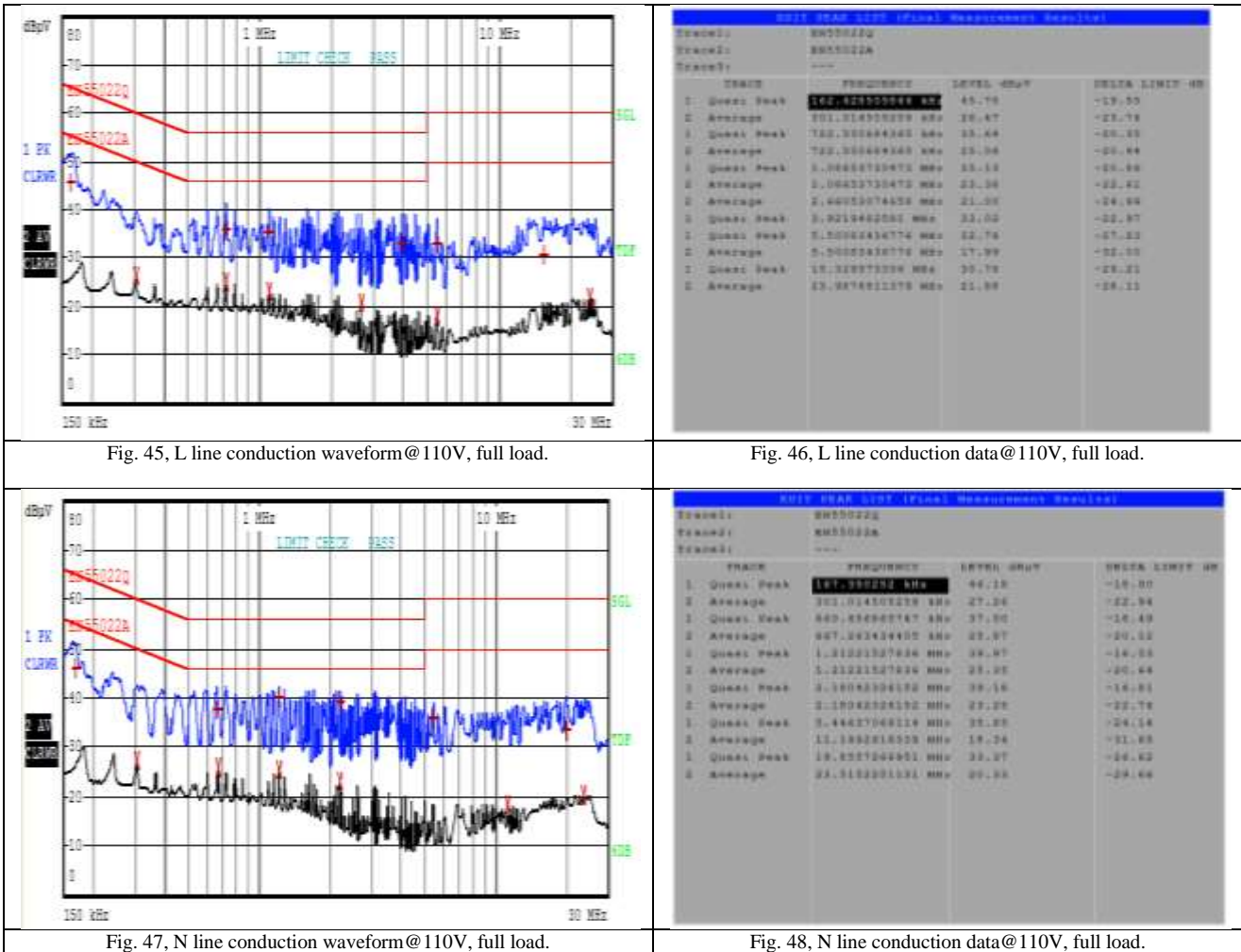

Fig. 45, L line conduction waveform@110V, full load.

Fig. 46, L line conduction data@110V, full load.

Fig. 47, N line conduction waveform@110V, full load.

Fig. 48, N line conduction data@110V, full load.

## 6. Revision control Table

Revision	Items Changed & added	The changing reason
1.0	Release	
Rev1.0 to Rev1.1	Relocated the F1 fusible resistor to L side from N	Ensure the fusible resistor protection open on Live side

**IMPORTANT NOTICE**

DIODES INCORPORATED MAKES NO WARRANTY OF ANY KIND, EXPRESS OR IMPLIED, WITH REGARDS TO THIS DOCUMENT, INCLUDING, BUT NOT LIMITED TO, THE IMPLIED WARRANTIES OF MERCHANTABILITY AND FITNESS FOR A PARTICULAR PURPOSE (AND THEIR EQUIVALENTS UNDER THE LAWS OF ANY JURISDICTION).

Diodes Incorporated and its subsidiaries reserve the right to make modifications, enhancements, improvements, corrections or other changes without further notice to this document and any product described herein. Diodes Incorporated does not assume any liability arising out of the application or use of this document or any product described herein; neither does Diodes Incorporated convey any license under its patent or trademark rights, nor the rights of others. Any Customer or user of this document or products described herein in such applications shall assume all risks of such use and will agree to hold Diodes Incorporated and all the companies whose products are represented on Diodes Incorporated website, harmless against all damages.

Diodes Incorporated does not warrant or accept any liability whatsoever in respect of any products purchased through unauthorized sales channel.

Should Customers purchase or use Diodes Incorporated products for any unintended or unauthorized application, Customers shall indemnify and hold Diodes Incorporated and its representatives harmless against all claims, damages, expenses, and attorney fees arising out of, directly or indirectly, any claim of personal injury or death associated with such unintended or unauthorized application.

Products described herein may be covered by one or more United States, international or foreign patents pending. Product names and markings noted herein may also be covered by one or more United States, international or foreign trademarks.

This document is written in English but may be translated into multiple languages for reference. Only the English version of this document is the final and determinative format released by Diodes Incorporated.

**LIFE SUPPORT**

Diodes Incorporated products are specifically not authorized for use as critical components in life support devices or systems without the express written approval of the Chief Executive Officer of Diodes Incorporated. As used herein:

A. Life support devices or systems are devices or systems which:

1. are intended to implant into the body, or
2. support or sustain life and whose failure to perform when properly used in accordance with instructions for use provided in the labeling can be reasonably expected to result in significant injury to the user.

B. A critical component is any component in a life support device or system whose failure to perform can be reasonably expected to cause the failure of the life support device or to affect its safety or effectiveness.

Customers represent that they have all necessary expertise in the safety and regulatory ramifications of their life support devices or systems, and acknowledge and agree that they are solely responsible for all legal, regulatory and safety-related requirements concerning their products and any use of Diodes Incorporated products in such safety-critical, life support devices or systems, notwithstanding any devices- or systems-related information or support that may be provided by Diodes Incorporated. Further, Customers must fully indemnify Diodes Incorporated and its representatives against any damages arising out of the use of Diodes Incorporated products in such safety-critical, life support devices or systems.

Copyright © 2016, Diodes Incorporated

[www.diodes.com](http://www.diodes.com)