

CARMEN-M2-C

~25° medium beam. Assembly with holder C compatible with LEDiL HEKLA.

SPECIFICATION:

| | |
|----------------|-----------|
| Dimensions | Ø 69.5 mm |
| Height | 41.5 mm |
| Fastening | socket |
| ROHS compliant | yes ⓘ |



MATERIALS:

| Component | Type | Material | Colour | Finish |
|--------------|-------------|----------|--------|--------|
| CARMEN-M2 | Single lens | PMMA | clear | |
| CARMEN-HLD-C | Holder | PC | black | |

ORDERING INFORMATION:

| Component | Type | Qty in box | MOQ | MPQ | Box weight (kg) |
|--------------------------------|-------------|------------|-----|-----|-----------------|
| CP17137_CARMEN-M2-C | Single lens | 150 | 150 | 15 | 8.8 |
| » Box size: 480 x 280 x 300 mm | | | | | |

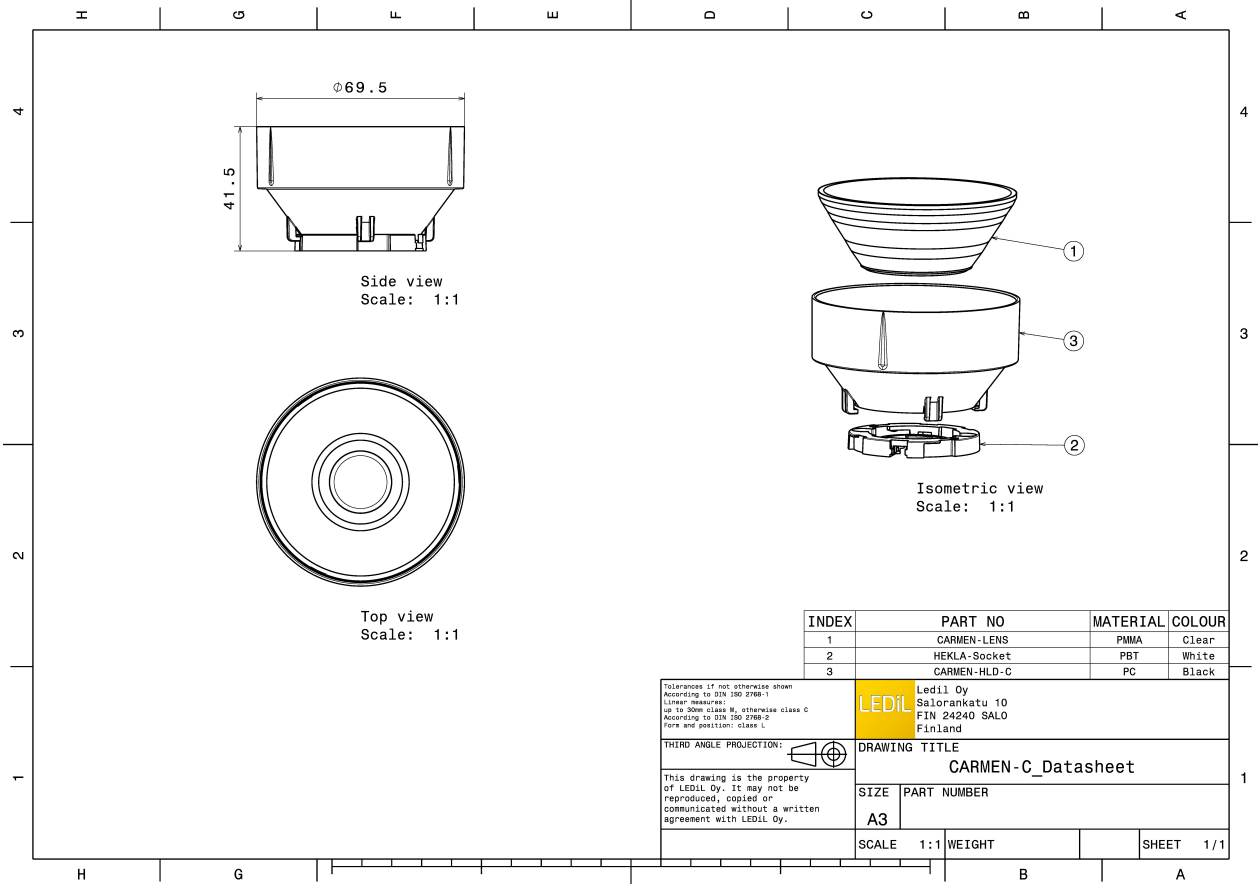

See also our general installation guide: www.ledil.com/installation_guide

OPTICAL RESULTS (MEASURED):

bridgelux.

LED Vesta DTW 13mm (21W)
 FWHM / FWTM 25.0° / 48.0°
 Efficiency 52 %
 Peak intensity 2.1 cd/lm
 LEDs/each optic 1
 Light colour Tunable White
 Required components:
 C16142_HEKLA-SOCKET-K
 Bender Wirth: 491 Typ L8



bridgelux.

LED Vesta TW 6mm DP
 FWHM / FWTM 23.0° / 38.0°
 Efficiency 62 %
 Peak intensity 3.5 cd/lm
 LEDs/each optic 1
 Light colour White
 Required components:
 C16142_HEKLA-SOCKET-K
 Bender Wirth: 504 Typ L8

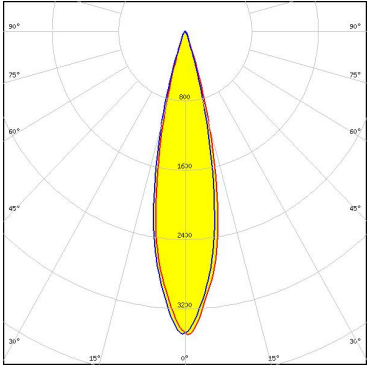
CITIZEN

LED CLU710/711
 FWHM / FWTM 24.0° / 39.0°
 Efficiency 63 %
 Peak intensity 3.3 cd/lm
 LEDs/each optic 1
 Light colour White
 Required components:
 F15859_HEKLA-SOCKET-I







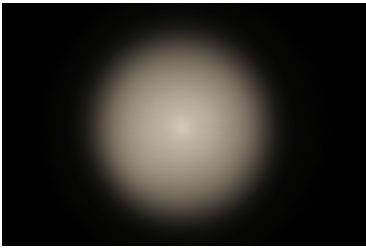
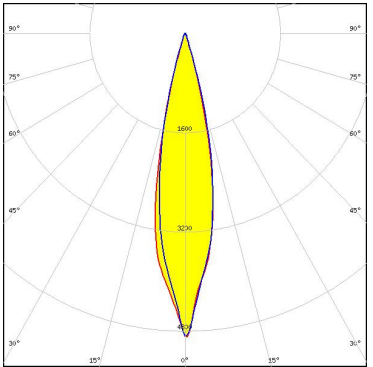

CITIZEN

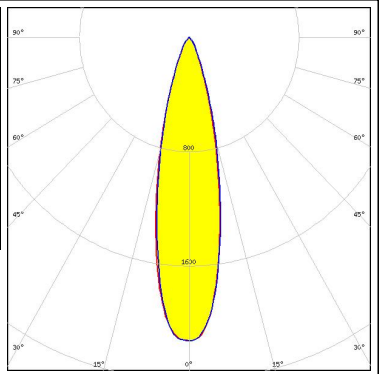

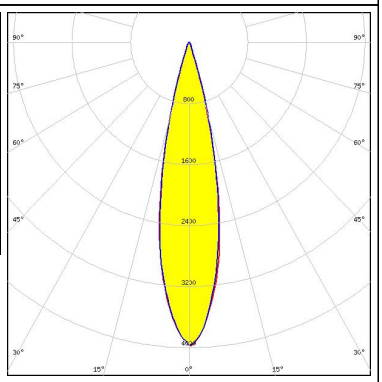
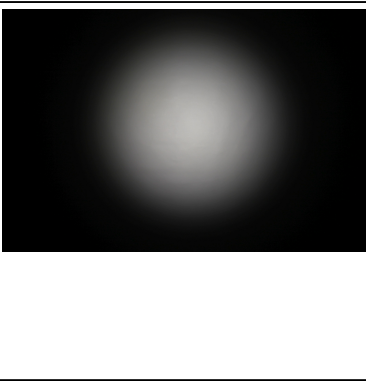
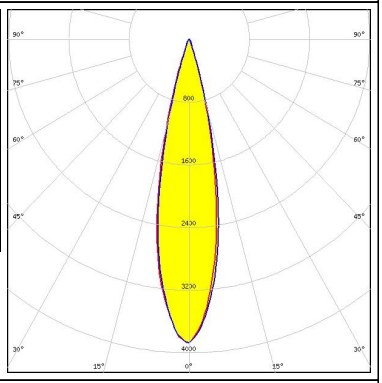

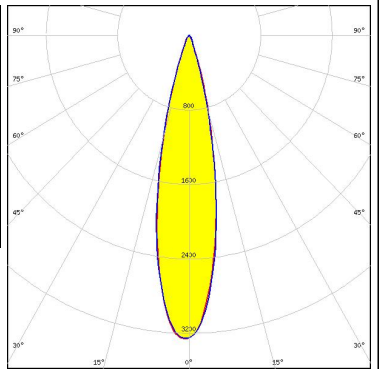
LED CLU7B2
 FWHM / FWTM 22.0° / 35.0°
 Efficiency 71 %
 Peak intensity 4.9 cd/lm
 LEDs/each optic 1
 Light colour White
 Required components:
 F15255_HEKLA-SOCKET-C

OPTICAL RESULTS (MEASURED):

| | | |
|--|--|---|
| <p>LUMILEDS</p> <p>LED LUXEON CX Plus CoB L08 (Gen2)</p> <p>FWHM / FWTM 25.0° / 48.0°</p> <p>Efficiency 54 %</p> <p>Peak intensity 2.1 cd/lm</p> <p>LEDs/each optic 1</p> <p>Light colour White</p> <p>Required components: Bender Wirth: 637a Hekla</p> |  |  |
| <p>LUMILEDS</p> <p>LED LUXEON CX Plus CoB - HD S01H4</p> <p>FWHM / FWTM 23.0° / 37.0°</p> <p>Efficiency 66 %</p> <p>Peak intensity 4 cd/lm</p> <p>LEDs/each optic 1</p> <p>Light colour White</p> <p>Required components: Bender Wirth: 634c Hekla</p> |  |  |
| <p>LUMILEDS</p> <p>LED LUXEON CX Plus CoB - HD S01H6 / HD S02H6</p> <p>FWHM / FWTM 23.0° / 37.0°</p> <p>Efficiency 65 %</p> <p>Peak intensity 3.9 cd/lm</p> <p>LEDs/each optic 1</p> <p>Light colour White</p> <p>Required components: Bender Wirth: 634c Hekla</p> |  |  |
| <p>LUMILEDS</p> <p>LED LUXEON CX Plus CoB - HD S04H9</p> <p>FWHM / FWTM 23.0° / 40.0°</p> <p>Efficiency 61 %</p> <p>Peak intensity 3.3 cd/lm</p> <p>LEDs/each optic 1</p> <p>Light colour White</p> <p>Required components: Bender Wirth: 634c Hekla</p> |  |  |

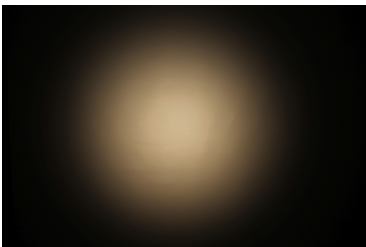
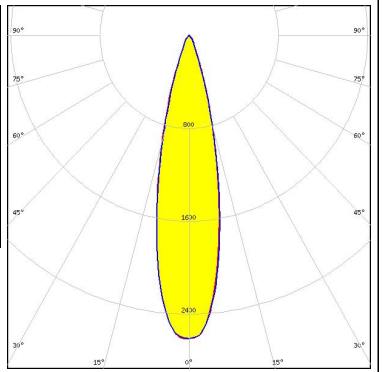

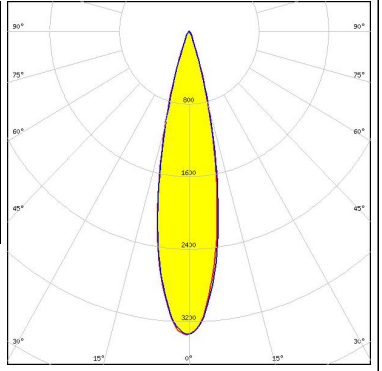
OPTICAL RESULTS (MEASURED):

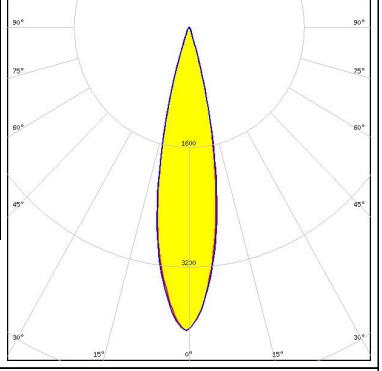
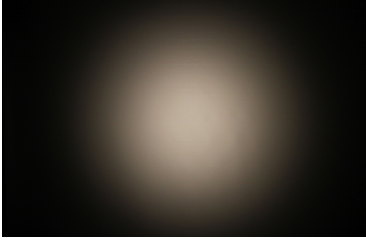
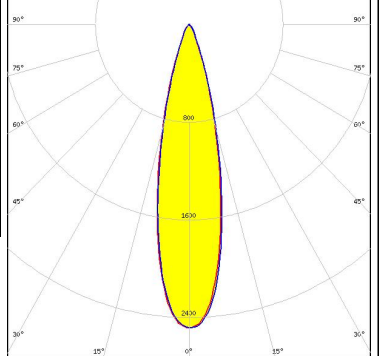
| | | |
|--|--|---|
| <p>LUMILEDS</p> <p>LED LUXEON CX Plus CoB L04 / L05 (Gen2)</p> <p>FWHM / FWTM 24.0° / 44.0°</p> <p>Efficiency 57 %</p> <p>Peak intensity 2.6 cd/m</p> <p>LEDs/each optic 1</p> <p>Light colour White</p> <p>Required components: Bender Wirth: 637a Hekla</p> |  |  |
| <p>LUMILEDS</p> <p>LED LUXEON CX Plus CoB M02 / M03 (Gen2)</p> <p>FWHM / FWTM 23.0° / 39.0°</p> <p>Efficiency 62 %</p> <p>Peak intensity 3.3 cd/m</p> <p>LEDs/each optic 1</p> <p>Light colour White</p> <p>Required components: Bender Wirth: 641a Hekla</p> |  |  |
| <p>LUMILEDS</p> <p>LED LUXEON CX Plus CoB S01 (Gen2)</p> <p>FWHM / FWTM 23.0° / 36.0°</p> <p>Efficiency 66 %</p> <p>Peak intensity 4.1 cd/m</p> <p>LEDs/each optic 1</p> <p>Light colour White</p> <p>Required components: Bender Wirth: 634c Hekla</p> |  |  |
| <p>LUMINUS</p> <p>LED CxM-11 (19x19)</p> <p>FWHM / FWTM 25.0° / 45.0°</p> <p>Efficiency 58 %</p> <p>Peak intensity 2.5 cd/m</p> <p>LEDs/each optic 1</p> <p>Light colour White</p> <p>Required components: F15859_HEKLA-SOCKET-I</p> |  |  |

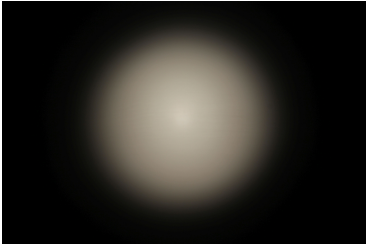
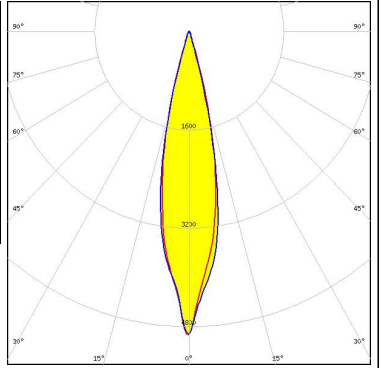
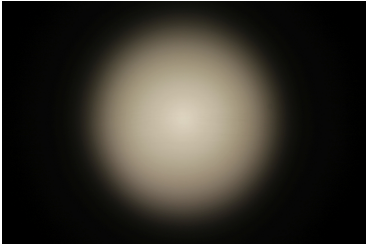
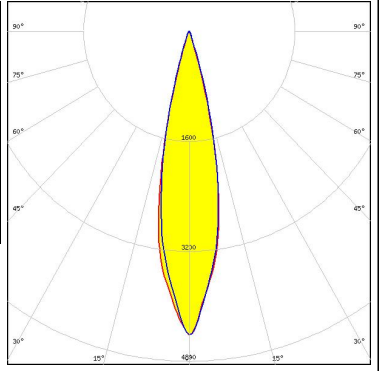
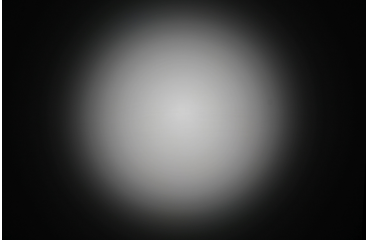
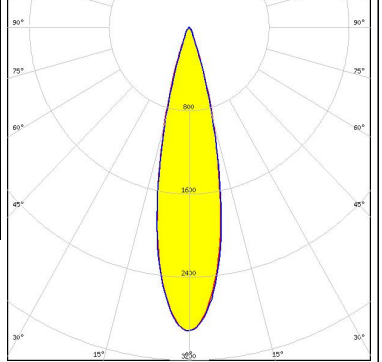
OPTICAL RESULTS (MEASURED):

| | | |
|---|--|---|
| <p>LUMINUS</p> <p>LED CXM-3 FWHM / FWTM 22.0° / 35.0° Efficiency 71 % Peak intensity 4.9 cd/lm LEDs/each optic 1 Light colour White Required components: F15255_HEKLA-SOCKET-C</p> |  |  |
| <p>LUMINUS</p> <p>LED CXM-4 FWHM / FWTM 23.0° / 35.0° Efficiency 69 % Peak intensity 4.4 cd/lm LEDs/each optic 1 Light colour White Required components: F15255_HEKLA-SOCKET-C</p> |  |  |
| <p>SAMSUNG</p> <p>LED LC010T (Tunable White) FWHM / FWTM 24.0° / 41.0° Efficiency 59 % Peak intensity 2.9 cd/lm LEDs/each optic 1 Light colour Tunable White Required components: C16142_HEKLA-SOCKET-K Bender Wirth: 501 Typ L8</p> |  |  |

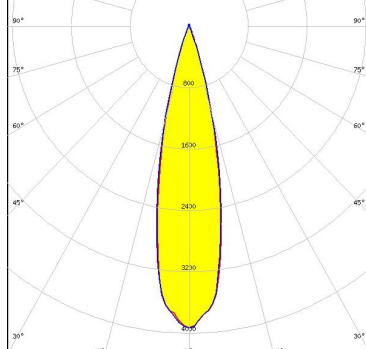
OPTICAL RESULTS (SIMULATED):

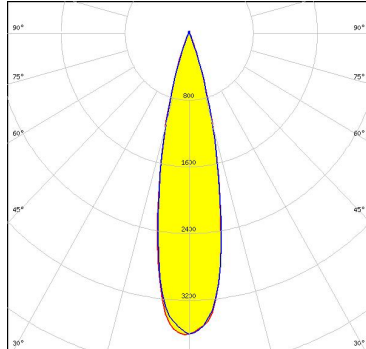
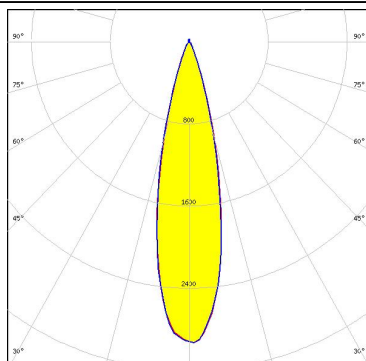
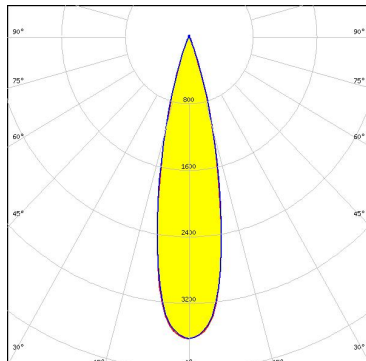
| | |
|--|---|
| <p></p> <p>LED V4 HD Gen 7 FWHM / FWTM 24.0° / 40.0° Efficiency 73 % Peak intensity 3.9 cd/lm LEDs/each optic 1 Light colour White Required components: F15253_HEKLA-SOCKET-A</p> |  |
| <p></p> <p>LED V6 HD Gen 7 FWHM / FWTM 24.0° / 41.0° Efficiency 69 % Peak intensity 3.6 cd/lm LEDs/each optic 1 Light colour White Required components: F15255_HEKLA-SOCKET-C</p> |  |
| <p>CITIZEN</p> <p>LED CLL02x/CLU02x (LES10) FWHM / FWTM 24.0° / 44.0° Efficiency 63 % Peak intensity 2.9 cd/lm LEDs/each optic 1 Light colour White Required components: F15255_HEKLA-SOCKET-C</p> |  |
| <p>CITIZEN</p> <p>LED CLU700/701/702/703 FWHM / FWTM 24.0° / 41.0° Efficiency 70 % Peak intensity 3.6 cd/lm LEDs/each optic 1 Light colour White Required components: F15255_HEKLA-SOCKET-C</p> |  |

OPTICAL RESULTS (SIMULATED):



LED CMA1825
 FWHM / FWTM 26.0° / 47.0°
 Efficiency 69 %
 Peak intensity 2.9 cd/lm
 LEDs/each optic 1
 Light colour White
 Required components:

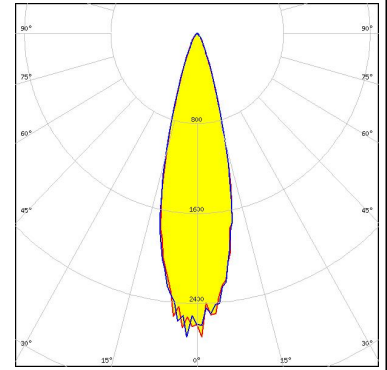

LED CMA1840
 FWHM / FWTM 29.0° / 52.0°
 Efficiency 66 %
 Peak intensity 2.2 cd/lm
 LEDs/each optic 1
 Light colour White
 Required components:

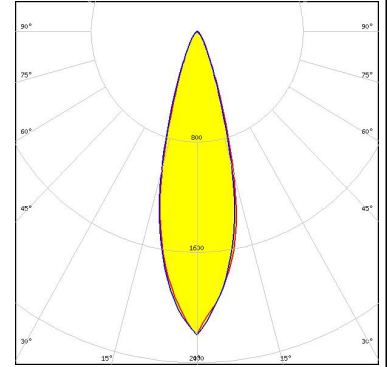

LED CxM-6 (13.5x13.5)
 FWHM / FWTM 24.0° / 42.0°
 Efficiency 69 %
 Peak intensity 3.6 cd/lm
 LEDs/each optic 1
 Light colour White
 Required components:
 F17435_HEKLA-G2-C

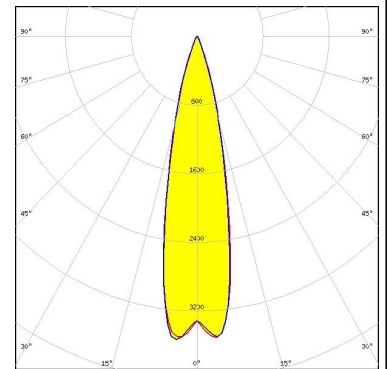

LED LC003D / LC006D / LC009D / LC013D
 FWHM / FWTM 25.0° / 43.0°
 Efficiency 62 %
 Peak intensity 2.9 cd/lm
 LEDs/each optic 1
 Light colour White
 Required components:
 F15255_HEKLA-SOCKET-C

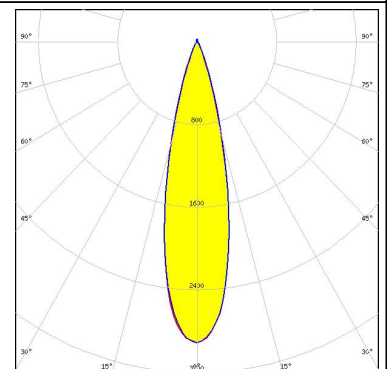

GENERAL INFORMATION:

NOTE: The typical beam angle will be changed by different color, chip size and chip position tolerance. The typical total beam angle is the full angle measured where the luminous intensity is half of the peak value.

Due to use of high power COB's with this product, special attention to proper thermal design is highly recommended. LEDiL has no liability for direct, indirect or consecutive damages arising from the LEDiL products being used outside of the recommended temperature range.

MATERIALS:

As part of our continuous research and improvement processes, and to ensure the best possible quality and availability of our products, LEDiL reserves the right to change material grades without notice.

PRODUCT DATA USER AGREEMENT AND DISCLAIMER:

The measured data in the provided downloadable LEDiL Product Datasheets and Mechanical 2D-Drawings is rounded and provided as reference for planning. LEDiL Oy's optical specifications have been verified by conducting performance testing of the products in accordance with the company's quality system. The reported data are averaged results of multiple measurements with typical variation. LEDiL Oy reserves the right to without prior notification make changes and improvements to its products.

LEDiL Oy assumes neither warranty, nor guarantee nor any other liability of any kind for the contents and correctness of the provided data. The provided data has been generated with highest diligence but the provided data may in reality not represent the complete possible variation range of all intrinsic parameters. Therefore, in certain cases a deviation from the provided data could occur.

LEDiL Oy reserves the right to undertake technical changes of its products without further notification which could lead to changes in the provided data. LEDiL Oy assumes no liability of any kind for the possible deviation from any provided data or any other damage resulting from the usage of the provided data.

The user agrees to this disclaimer and user agreement with the download or usage of the provided files.

LEDiL Oy

Joensuunkatu 13
FI-24240 SALO
Finland

LEDiL Inc.

228 West Page Street
Suite D
Sycamore IL 60178
USA

Ledil Optics Technology (Shenzhen) Co., Ltd.

405 , Block B
Casic Motor Building
Shenzhen 518057
P.R.CHINA

Local sales and technical support

[www.ledil.com/
where_to_buy](http://www.ledil.com/where_to_buy)

Shipping locations

Salo, Finland
Hong Kong, China

Distribution Partners

[www.ledil.com/
where_to_buy](http://www.ledil.com/where_to_buy)