



Is Now Part of



ON Semiconductor®

To learn more about ON Semiconductor, please visit our website at
www.onsemi.com

Please note: As part of the Fairchild Semiconductor integration, some of the Fairchild orderable part numbers will need to change in order to meet ON Semiconductor's system requirements. Since the ON Semiconductor product management systems do not have the ability to manage part nomenclature that utilizes an underscore (_), the underscore (_) in the Fairchild part numbers will be changed to a dash (-). This document may contain device numbers with an underscore (_). Please check the ON Semiconductor website to verify the updated device numbers. The most current and up-to-date ordering information can be found at www.onsemi.com. Please email any questions regarding the system integration to Fairchild_questions@onsemi.com.

ON Semiconductor and the ON Semiconductor logo are trademarks of Semiconductor Components Industries, LLC dba ON Semiconductor or its subsidiaries in the United States and/or other countries. ON Semiconductor owns the rights to a number of patents, trademarks, copyrights, trade secrets, and other intellectual property. A listing of ON Semiconductor's product/patent coverage may be accessed at www.onsemi.com/site/pdf/Patent-Marking.pdf. ON Semiconductor reserves the right to make changes without further notice to any products herein. ON Semiconductor makes no warranty, representation or guarantee regarding the suitability of its products for any particular purpose, nor does ON Semiconductor assume any liability arising out of the application or use of any product or circuit, and specifically disclaims any and all liability, including without limitation special, consequential or incidental damages. Buyer is responsible for its products and applications using ON Semiconductor products, including compliance with all laws, regulations and safety requirements or standards, regardless of any support or applications information provided by ON Semiconductor. "Typical" parameters which may be provided in ON Semiconductor data sheets and/or specifications can and do vary in different applications and actual performance may vary over time. All operating parameters, including "Typicals" must be validated for each customer application by customer's technical experts. ON Semiconductor does not convey any license under its patent rights nor the rights of others. ON Semiconductor products are not designed, intended, or authorized for use as a critical component in life support systems or any FDA Class 3 medical devices or medical devices with a same or similar classification in a foreign jurisdiction or any devices intended for implantation in the human body. Should Buyer purchase or use ON Semiconductor products for any such unintended or unauthorized application, Buyer shall indemnify and hold ON Semiconductor and its officers, employees, subsidiaries, affiliates, and distributors harmless against all claims, costs, damages, and expenses, and reasonable attorney fees arising out of, directly or indirectly, any claim of personal injury or death associated with such unintended or unauthorized use, even if such claim alleges that ON Semiconductor was negligent regarding the design or manufacture of the part. ON Semiconductor is an Equal Opportunity/Affirmative Action Employer. This literature is subject to all applicable copyright laws and is not for resale in any manner.



FGY40T120SMD

1200 V, 40 A Field Stop Trench IGBT

Features

- FS Trench Technology, Positive Temperature Coefficient
- High Speed Switching
- Low Saturation Voltage: $V_{CE(sat)} = 1.8 \text{ V @ } I_C = 40 \text{ A}$
- 100% of the Parts tested for $I_{LM}(1)$
- High Input Impedance
- RoHS Compliant

General Description

Using innovative field stop trench IGBT technology, Fairchild's new series of field stop trench IGBTs offer the optimum performance for hard switching application such as solar inverter, UPS, welder and PFC applications.

Applications

- Solar Inverter, Welder, UPS & PFC applications.

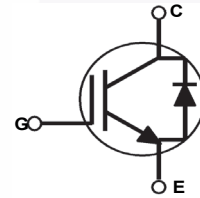
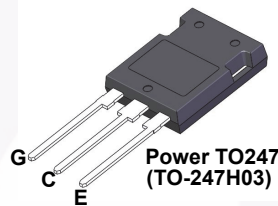

Absolute Maximum Ratings $T_C = 25^\circ\text{C}$ unless otherwise noted

Symbol	Description	FGY40T120SMD	Unit
V_{CES}	Collector to Emitter Voltage	1200	V
V_{GES}	Gate to Emitter Voltage	± 25	V
	Transient Gate to Emitter Voltage	± 30	V
I_C	Collector Current @ $T_C = 25^\circ\text{C}$	80	A
	Collector Current @ $T_C = 100^\circ\text{C}$	40	A
$I_{LM}(1)$	Clamped Inductive Load Current @ $T_C = 25^\circ\text{C}$	160	A
$I_{CM}(2)$	Pulsed Collector Current	160	A
I_F	Diode Continuous Forward Current @ $T_C = 25^\circ\text{C}$	80	A
	Diode Continuous Forward Current @ $T_C = 100^\circ\text{C}$	40	A
I_{FM}	Diode Maximum Forward Current	240	A
P_D	Maximum Power Dissipation @ $T_C = 25^\circ\text{C}$	882	W
	Maximum Power Dissipation @ $T_C = 100^\circ\text{C}$	441	W
T_J	Operating Junction Temperature	-55 to +175	$^\circ\text{C}$
T_{stg}	Storage Temperature Range	-55 to +175	$^\circ\text{C}$
T_L	Maximum Lead Temp. for soldering Purposes, 1/8" from case for 5 seconds	300	$^\circ\text{C}$

Thermal Characteristics

Symbol	Parameter	Typ.	Max.	Unit
$R_{\theta JC}(\text{IGBT})$	Thermal Resistance, Junction to Case	--	0.17	$^\circ\text{C/W}$
$R_{\theta JC}(\text{Diode})$	Thermal Resistance, Junction to Case	--	0.55	$^\circ\text{C/W}$
$R_{\theta JA}$	Thermal Resistance, Junction to Ambient	--	40	$^\circ\text{C/W}$

Notes:
 1. $V_{CC} = 600 \text{ V}, V_{GE} = 15 \text{ V}, I_C = 160 \text{ A}, R_G = 10 \ \Omega$, Inductive Load
 2. Limited by T_{jmax}

Package Marking and Ordering Information

Device Marking	Device	Package	Reel Size	Tape Width	Quantity
FGY40T120SMD	FGY40T120SMD	TP-247	-	-	30

Electrical Characteristics of the IGBT T_C = 25°C unless otherwise noted

Symbol	Parameter	Test Conditions	Min.	Typ.	Max.	Unit
Off Characteristics						
BV_{CES}	Collector to Emitter Breakdown Voltage	$V_{GE} = 0\text{ V}, I_C = 250\text{ }\mu\text{A}$	1200	-	-	V
I_{CES}	Collector Cut-Off Current	$V_{CE} = V_{CES}, V_{GE} = 0\text{ V}$	-	-	250	μA
I_{GES}	G-E Leakage Current	$V_{GE} = V_{GES}, V_{CE} = 0\text{ V}$	-	-	± 400	nA
On Characteristics						
$V_{GE(th)}$	G-E Threshold Voltage	$I_C = 40\text{ mA}, V_{CE} = V_{GE}$	4.9	6.2	7.5	V
$V_{CE(sat)}$	Collector to Emitter Saturation Voltage	$I_C = 40\text{ A}, V_{GE} = 15\text{ V}$ $T_C = 25^\circ\text{C}$	-	1.8	2.4	V
		$I_C = 40\text{ A}, V_{GE} = 15\text{ V},$ $T_C = 175^\circ\text{C}$	-	2.0	-	V
Dynamic Characteristics						
C_{ies}	Input Capacitance	$V_{CE} = 30\text{ V}, V_{GE} = 0\text{ V},$ $f = 1\text{ MHz}$	-	4300	-	pF
C_{oes}	Output Capacitance		-	180	-	pF
C_{res}	Reverse Transfer Capacitance		-	100	-	pF
Switching Characteristics						
$t_{d(on)}$	Turn-On Delay Time	$V_{CC} = 600\text{ V}, I_C = 40\text{ A},$ $R_G = 10\text{ }\Omega, V_{GE} = 15\text{ V},$ Inductive Load, $T_C = 25^\circ\text{C}$	-	40	-	ns
t_r	Rise Time		-	47	-	ns
$t_{d(off)}$	Turn-Off Delay Time		-	475	-	ns
t_f	Fall Time		-	10	-	ns
E_{on}	Turn-On Switching Loss		-	2.7	-	mJ
E_{off}	Turn-Off Switching Loss		-	1.1	-	mJ
E_{ts}	Total Switching Loss		-	3.8	-	mJ
$t_{d(on)}$	Turn-On Delay Time	$V_{CC} = 600\text{ V}, I_C = 40\text{ A},$ $R_G = 10\text{ }\Omega, V_{GE} = 15\text{ V},$ Inductive Load, $T_C = 175^\circ\text{C}$	-	40	-	ns
t_r	Rise Time		-	55	-	ns
$t_{d(off)}$	Turn-Off Delay Time		-	520	-	ns
t_f	Fall Time		-	50	-	ns
E_{on}	Turn-On Switching Loss		-	3.4	-	mJ
E_{off}	Turn-Off Switching Loss		-	2.5	-	mJ
E_{ts}	Total Switching Loss		-	5.9	-	mJ
Q_g	Total Gate Charge	$V_{CE} = 600\text{ V}, I_C = 40\text{ A},$ $V_{GE} = 15\text{ V}$	-	370	-	nC
Q_{ge}	Gate to Emitter Charge		-	23	-	nC
Q_{gc}	Gate to Collector Charge		-	210	-	nC

Electrical Characteristics of the DIODE T_C = 25°C unless otherwise noted

Symbol	Parameter	Test Conditions	Min.	Typ.	Max.	Unit
V _{FM}	Diode Forward Voltage	I _F = 40 A, T _C = 25°C	-	3.8	4.8	V
		I _F = 40 A, T _C = 175°C	-	2.7	-	V
t _{rr}	Diode Reverse Recovery Time	V _R = 600 V, I _F = 40 A, di _F /dt = 200 A/us, T _C = 25°C	-	65	-	ns
Q _{rr}	Diode Reverse Recovery Charge		-	234	-	nC
E _{rec}	Reverse Recovery Energy	V _R = 600 V, I _F = 40 A, di _F /dt = 200 A/us, T _C = 175°C	-	97	-	μJ
t _{rr}	Diode Reverse Recovery Time		-	200	-	ns
Q _{rr}	Diode Reverse Recovery Charge		-	1800	-	nC

Typical Performance Characteristics

Figure 1. Typical Output Characteristics

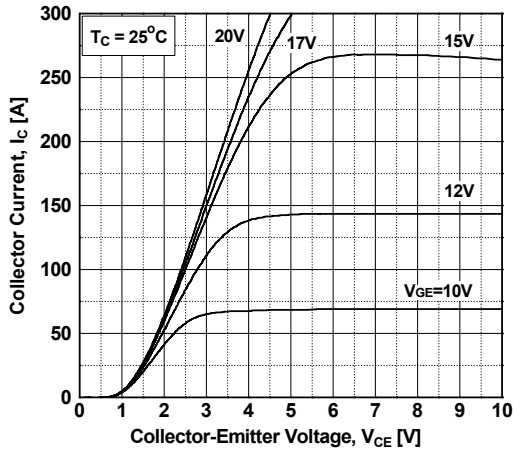

Figure 2. Typical Output Characteristics

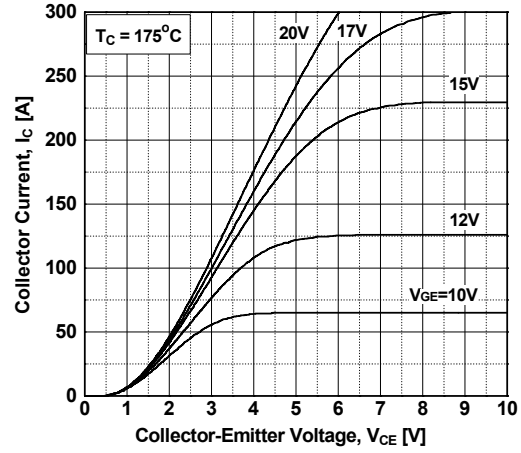

Figure 3. Typical Saturation Voltage Characteristics

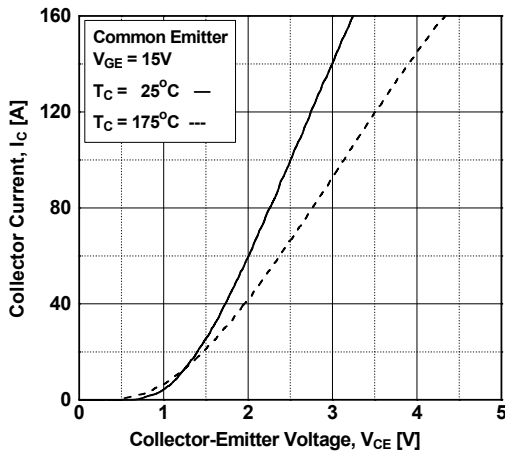

Figure 4. Saturation Voltage vs. Case Temperature at Variant Current Level

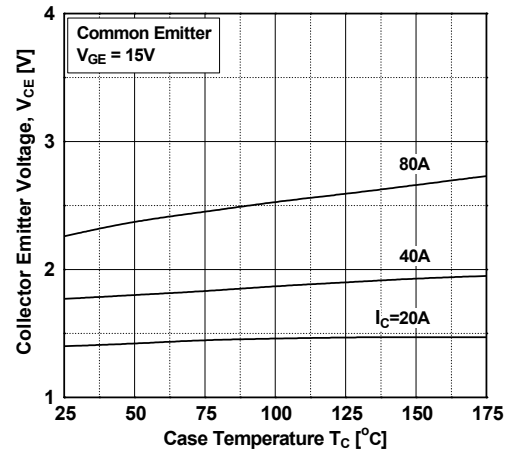

Figure 5. Saturation Voltage vs. Vge

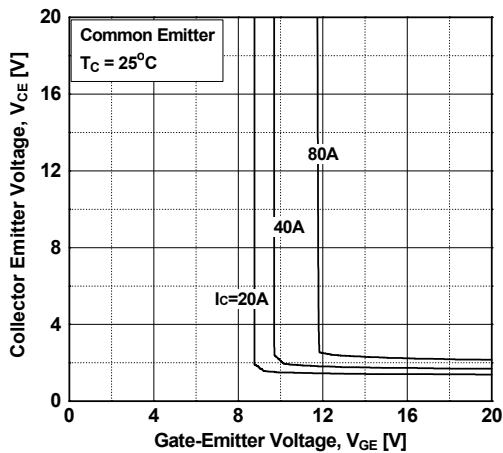
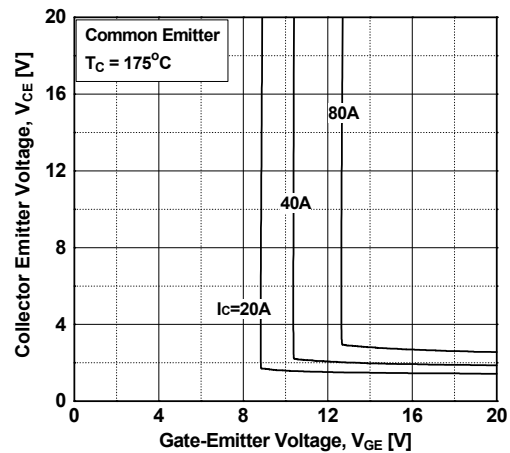

Figure 6. Saturation Voltage vs. Vge



Typical Performance Characteristics

Figure 7. Capacitance Characteristics

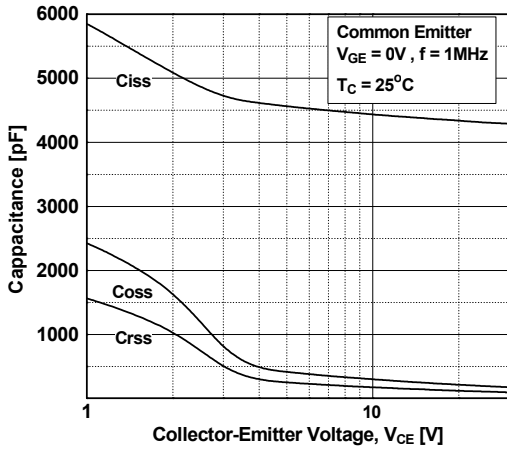

Figure 8. Load Current vs. Frequency

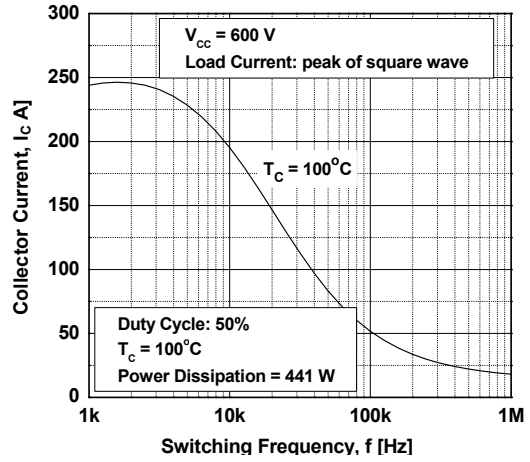

Figure 9. Turn-on Characteristics vs. Gate Resistance

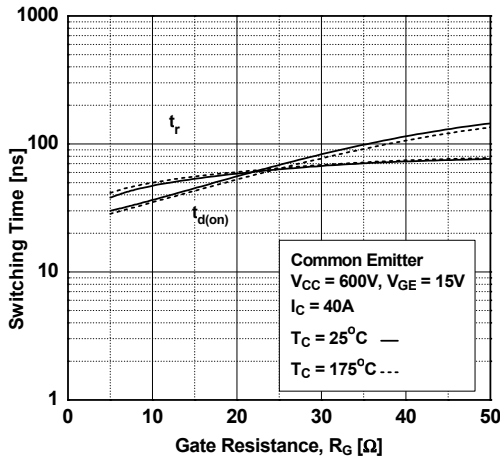

Figure 10. Turn-off Characteristics vs. Gate Resistance

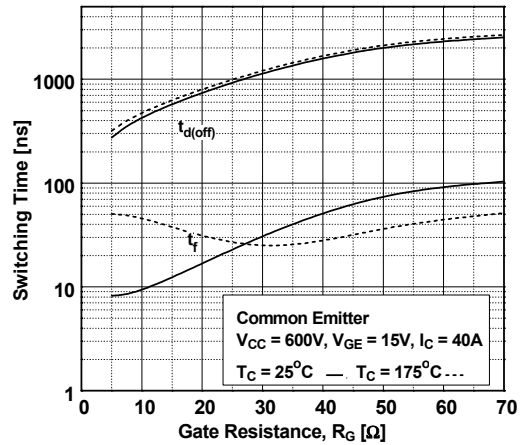

Figure 11. Switching Loss vs. Gate Resistance

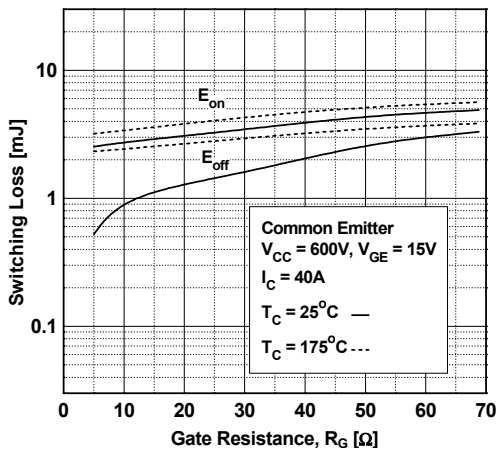
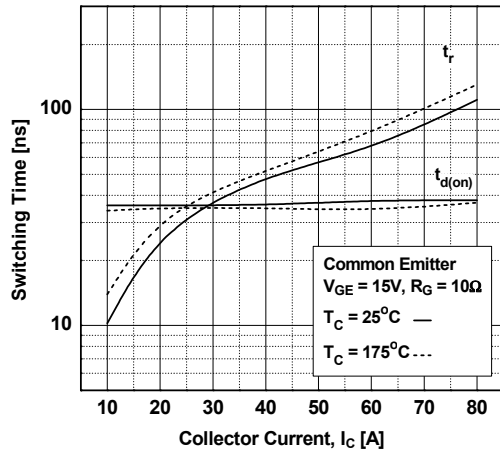

Figure 12. Turn-on Characteristics vs. Collector Current



Typical Performance Characteristics

Figure 13. Turn-off Characteristics vs. Collector Current

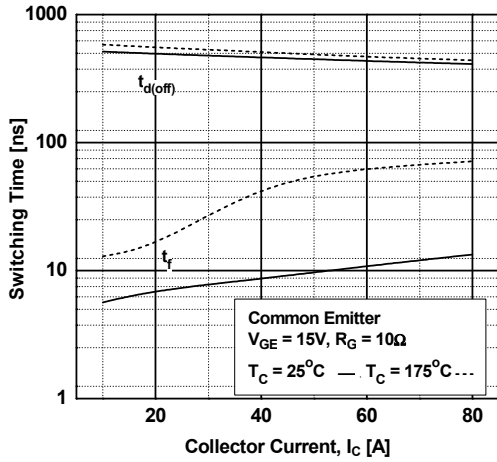

Figure 14. Switching Loss vs. Collector Current

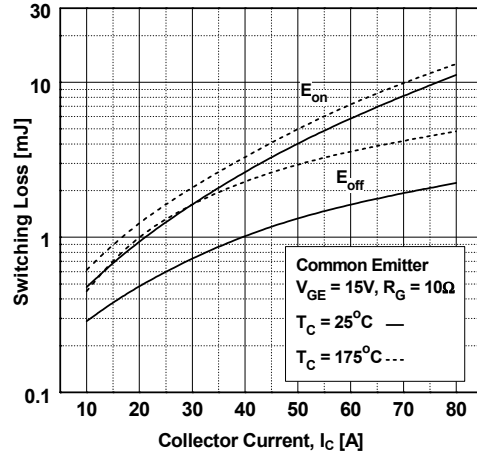

Figure 15. Gate Charge Characteristics

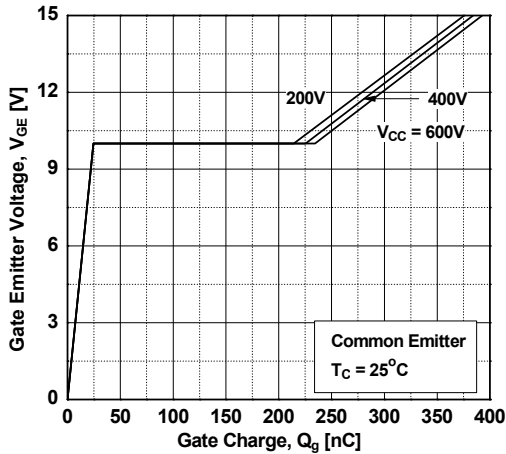

Figure 16. SOA Characteristics

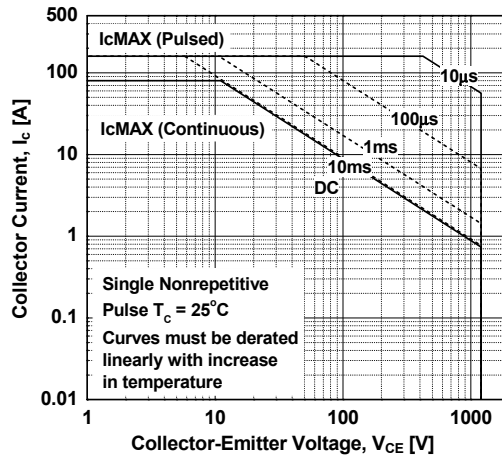

Figure 17. Forward Characteristics

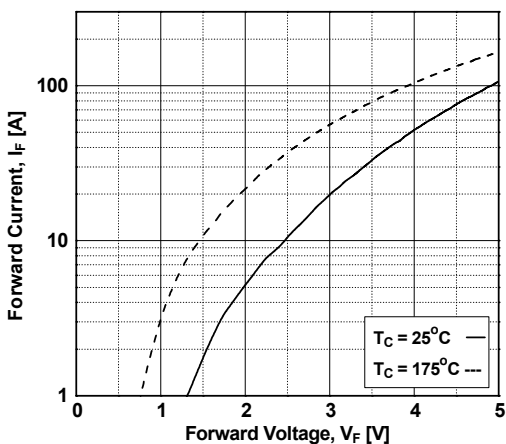
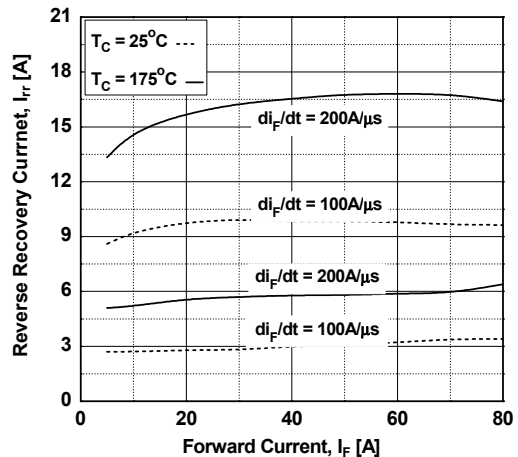

Figure 18. Reverse Recovery Current



Typical Performance Characteristics

Figure 19. Reverse Recovery Time

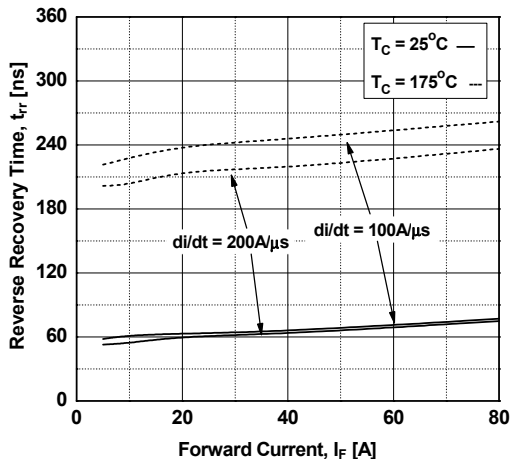

Figure 20. Stored Charge

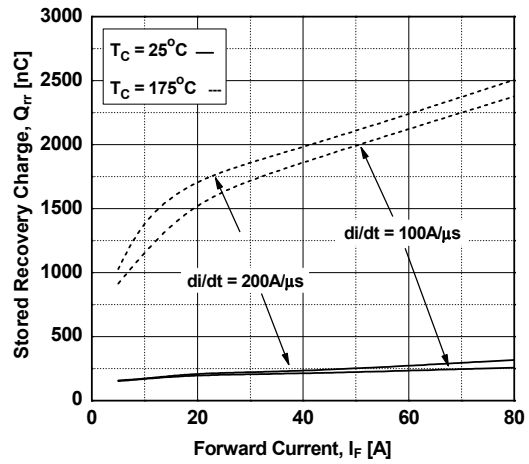

Figure 21. Transient Thermal Impedance of IGBT

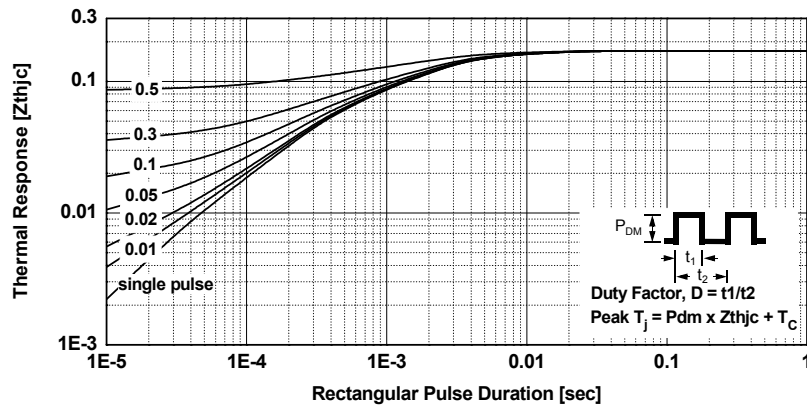
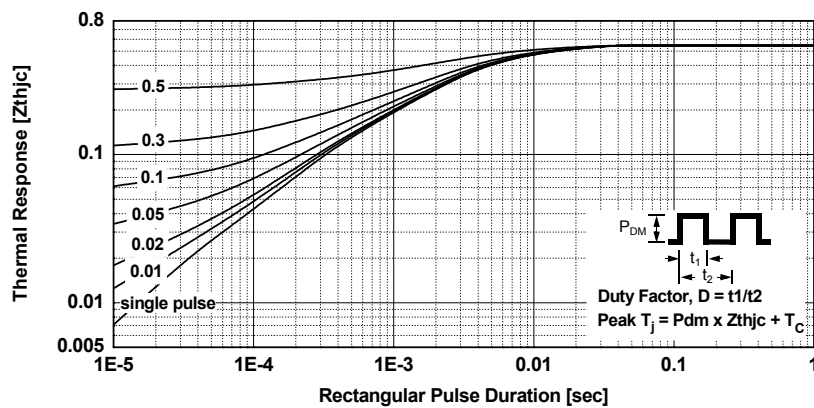
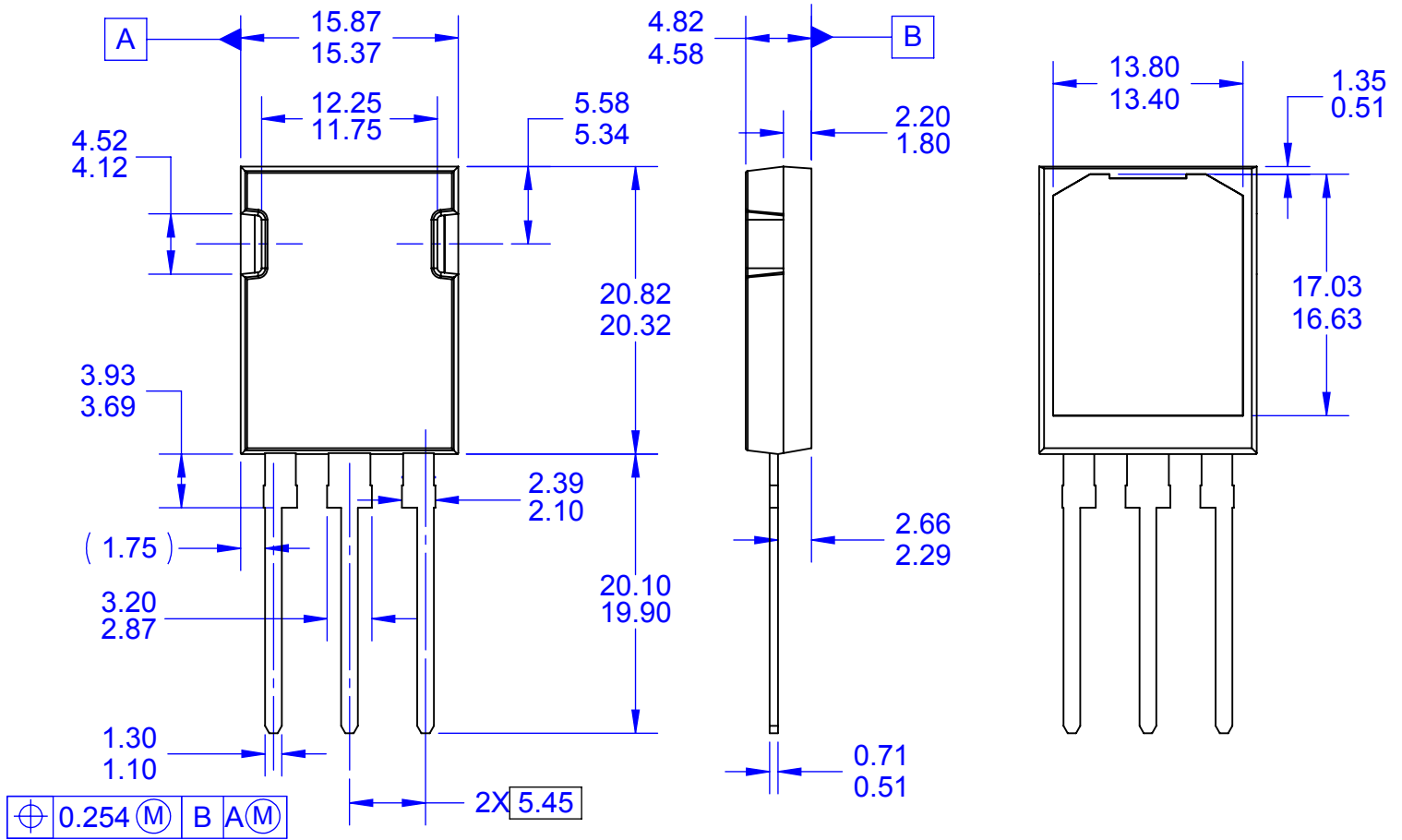

Figure 22. Transient Thermal Impedance of Diode





FRONT VIEW

SIDE VIEW

BOTTOM VIEW

NOTES:

- A. THIS PACKAGE DOES NOT CONFORM TO ANY STANDARDS.
- B. ALL DIMENSIONS ARE IN MILLIMETERS.
- C. DIMENSIONS ARE EXCLUSIVE OF BURRS, MOLD FLASH AND TIE BAR PROTRUSIONS.
- D. DIMENSION AND TOLERANCE AS PER ASME Y14.5-2009.
- E. DRAWING FILE NAME: TO247H03REV1



ON Semiconductor and  are trademarks of Semiconductor Components Industries, LLC dba ON Semiconductor or its subsidiaries in the United States and/or other countries. ON Semiconductor owns the rights to a number of patents, trademarks, copyrights, trade secrets, and other intellectual property. A listing of ON Semiconductor's product/patent coverage may be accessed at www.onsemi.com/site/pdf/Patent-Marking.pdf. ON Semiconductor reserves the right to make changes without further notice to any products herein. ON Semiconductor makes no warranty, representation or guarantee regarding the suitability of its products for any particular purpose, nor does ON Semiconductor assume any liability arising out of the application or use of any product or circuit, and specifically disclaims any and all liability, including without limitation special, consequential or incidental damages. Buyer is responsible for its products and applications using ON Semiconductor products, including compliance with all laws, regulations and safety requirements or standards, regardless of any support or applications information provided by ON Semiconductor. "Typical" parameters which may be provided in ON Semiconductor data sheets and/or specifications can and do vary in different applications and actual performance may vary over time. All operating parameters, including "Typicals" must be validated for each customer application by customer's technical experts. ON Semiconductor does not convey any license under its patent rights nor the rights of others. ON Semiconductor products are not designed, intended, or authorized for use as a critical component in life support systems or any FDA Class 3 medical devices or medical devices with a same or similar classification in a foreign jurisdiction or any devices intended for implantation in the human body. Should Buyer purchase or use ON Semiconductor products for any such unintended or unauthorized application, Buyer shall indemnify and hold ON Semiconductor and its officers, employees, subsidiaries, affiliates, and distributors harmless against all claims, costs, damages, and expenses, and reasonable attorney fees arising out of, directly or indirectly, any claim of personal injury or death associated with such unintended or unauthorized use, even if such claim alleges that ON Semiconductor was negligent regarding the design or manufacture of the part. ON Semiconductor is an Equal Opportunity/Affirmative Action Employer. This literature is subject to all applicable copyright laws and is not for resale in any manner.

PUBLICATION ORDERING INFORMATION

LITERATURE FULFILLMENT:

Literature Distribution Center for ON Semiconductor
19521 E. 32nd Pkwy, Aurora, Colorado 80011 USA
Phone: 303-675-2175 or 800-344-3860 Toll Free USA/Canada
Fax: 303-675-2176 or 800-344-3867 Toll Free USA/Canada
Email: orderlit@onsemi.com

N. American Technical Support: 800-282-9855 Toll Free
USA/Canada
Europe, Middle East and Africa Technical Support:
Phone: 421 33 790 2910
Japan Customer Focus Center
Phone: 81-3-5817-1050

ON Semiconductor Website: www.onsemi.com
Order Literature: <http://www.onsemi.com/orderlit>
For additional information, please contact your local
Sales Representative