

**HARSH ENVIRONMENT  
PC, DVI, HDMI, VIDEO INTERFACE CONTROLLER  
FOR TFT PANEL**

**Model: HX-1920v3**

Part number : 41748012X/3X-3 or up

**INSTRUCTIONS**

**CONTENTS**

Page: **2. Introduction, How to Proceed, Usage Note, Disclaimer**  
**3. System design** – Diagram of a suggested system  
**4. Assembly notes** – Important information about system elements  
**7. Connection & Operation** – How to use the controller  
**14. Connectors, pinouts & jumpers** – Essential connection information  
**26. Controller dimensions**  
**27. Application notes**  
**29. Troubleshooting**  
**30. Specifications**  
**31. Appendix I** – Supported graphics modes table  
**34. Appendix II** – RS-232 control protocols  
**47. Appendix III** – Mapping definition  
**51. Appendix IV** – Auto Color Gain  
**52. Appendix V** – DV remote control unit work for HX-1920v3  
**53. Appendix VI** - PIP mix table  
**56. Appendix VII** - Network connection  
**57. Appendix VIII** - HD-1000/ HD-2000 / HD-3000S connection  
**60. Appendix IX** – Procedure for showing how to select the baud rate  
**62. Warranty, Caution & Limitation of Liability, Trademarks**  
**63. Contact details**  
**64. Revision History**

**It is essential that these instructions are read and understood before connecting or powering up this controller.**

## Introduction

HX-1920v3 is the harsh Environment version of the SVX-1920v3. Provides full SVX-1920v3 feature set, plus wide range operating temperature and voltage range; shock and vibration tolerance and conformal coating for extreme environment applications.

- TFT (active matrix) LCD panels of 1920x1200, 1920x1080, 1920x480, 1680x1050, 1600x1200, 1600x900, 1440x900, 1366x768, 1280x1024, 1280x800, 1280x768, 1024x768, 1024x600, 800x600, 800x480 and 640x480 resolutions.
- Computer video signals of VGA, SVGA, XGA, SXGA, WXGA, UXGA, WUXGA standard.
- Support true 10 bits panel
- Support HDMI, DVI, VGA, Component Video input
- Low mass tantalum capacitors for maximum vibration and shock tolerance, conformal coating, operating temperature range from -40°C to +80°C plus calculated MTBF in excess of 100K hours.
- Overall suitability for usage in critical applications must be independently tested and verified by the user.

### Ordering information :

Controller	Part number	Ordering part number
HX-1920v3	P/N 41748012X-3 or P/N 41748013X-3	P/N 4174801XX-3

### HOW TO PROCEED

- Ensure you have all parts & that they are correct, refer to:
  - Connection diagram

#### Controller Solution Generator

Full web resource matching controllers & panels with **connection diagrams** for download.  
See at : <http://www.digitalview.com/controllers/csg.php>

- Connector reference (in following section)
- Assembly notes
- Check controller switch & jumper settings (errors may damage the panel)
- Prepare the PC
- Connect the parts
- Understand the operation & functions

### IMPORTANT USAGE NOTE

This equipment is for use by developers and integrators, the manufacturer accepts no liability for damage or injury caused by the use of this product. It is the responsibility of the developer, integrators or other user of this product to:

- Ensure that all necessary and appropriate safety measures are taken.
- Obtain suitable regulatory approvals as may be required.
- **Check power settings to all component parts before connection.**

### DISCLAIMER

There is no implied or expressed warranty regarding this material.

## SYSTEM DESIGN

A typical LCD based display system utilizing this controller is likely to comprise the following:

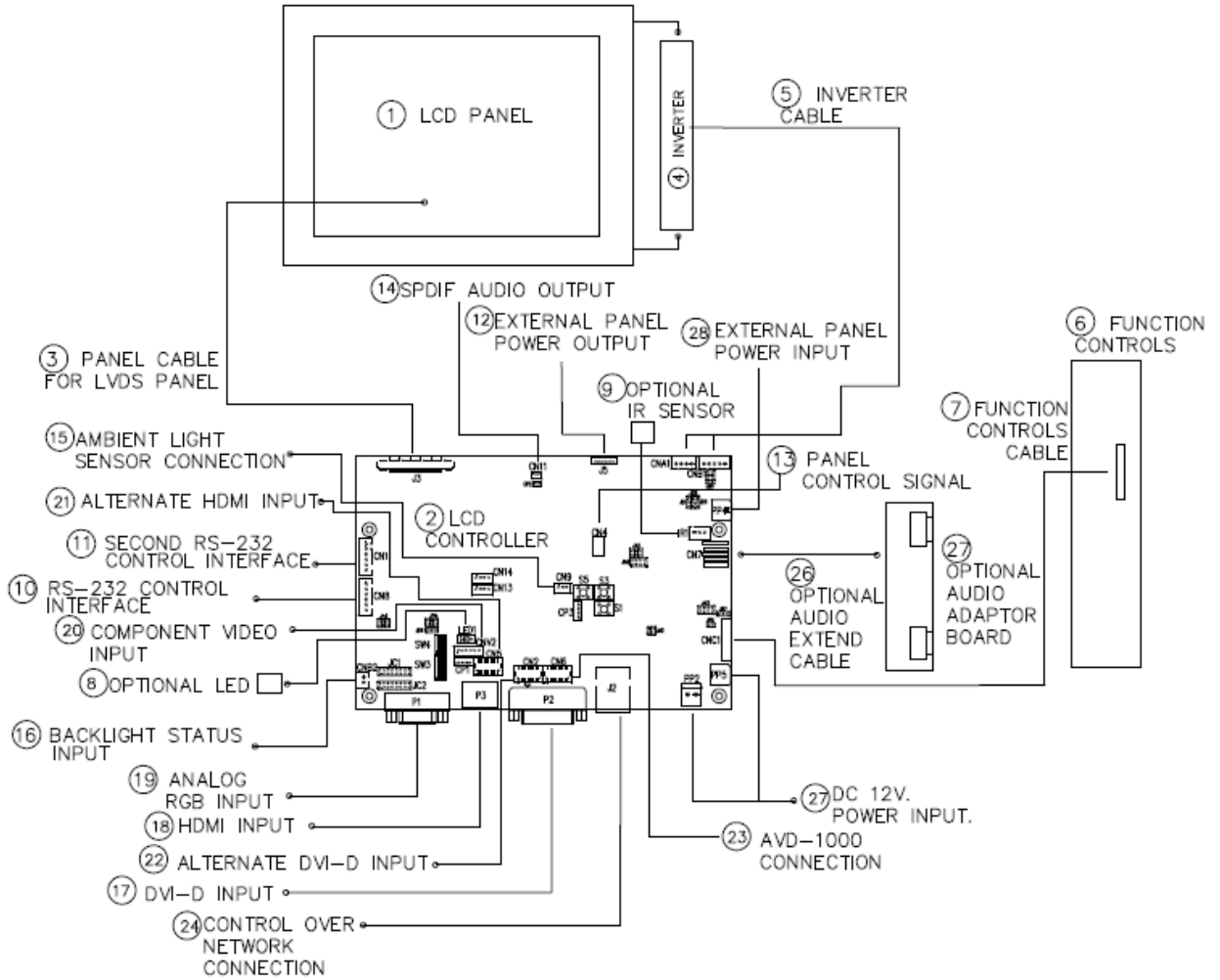

## ASSEMBLY NOTES

This controller is designed for monitor and custom display projects using 1920x1200 or 1920x1080 or 1600x1200 or 1680x1050 or 1440x900 or 1366x768 or 1280 x 1024 or 1024 x 768 or 800x600 or 640x480 resolution TFT panels with a VGA, SVGA, WXGA, XGA, SXGA, UXGA or WUXGA signal input. The following provides some guidelines for installation and preparation of a finished display solution.

**Preparation:** Before proceeding it is important to familiarize yourself with the parts making up the system and the various connectors, mounting holes and general layout of the controller. As much as possible connectors have been labeled. Guides to connectors and mounting holes are shown in the following relevant sections.

1. **LCD Panel:** This controller is designed for typical LVDS interfaced panels with panel voltage 3.3V, 5V, 12V or 18V, External for 12V~18V interface. Due to the variation between manufacturers of panels signal timing and other panel characteristics, factory setup and confirmation should be obtained before connecting to a panel. **(NOTE: Check panel power jumper settings before connection)**
2. **Controller:** Handle the controller with care as static charge may damage electronic components. Make sure correct jumper and dip switches settings to match the target LCD panel.
3. **LCD signal cable (LVDS panel):** In order to provide a clean signal it is recommended that LVDS signal cables are no longer than 46cm (18 inches). If those wire cabling is utilized these can be made into a harness with cable ties. Care should be taken when placing the cables to avoid signal interference. Additionally it may be necessary in some systems to add ferrite cores to the cable to minimize signal noise.
4. **Inverter:** This will be required for the backlight of an LCD, some LCD panels have an inverter built in. As LCD panels may have 1 or more backlight tubes and the power requirements for different panel backlights may vary it is important to match the inverter in order to obtain optimum performance. See Application notes page 27 for more information on connection.
5. **Inverter Cables:** Different inverter models require different cables and different pin assignment. Make sure correct cable pin out to match inverter. Using wrong cable pin out may damage the inverter.
6. **Function Controls:** The following section discusses the controls required and the section on connectors provides the detail. The controls are minimal: On/Off, Backlight Brightness (depends on inverter), OSD (5 momentary buttons) analog VR type or (8 momentary buttons) digital type.
7. **Function controls cable:** The cables to the function switches should be of suitable quality and length so that impedance does not affect performance. Generally lengths up to 1 meter (3 feet) should be acceptable.
8. **Status LED:** The pin direction of the LED should be corrected for right color indication. Red color stands for standby. Green colors stands for signal on. The status LED is an optional part only, can be unconnected.
9. **IR sensor:** It is an optional part only, can be unconnected if not using IR remote control. See Appendix V in details.
10. **RS-232 control interface :** Firmware upgrade and serial control via this interface port.
11. **Second RS-232 control interface :** This interface support controlled under "Programming mode" . Press and hold "MENU" button on the OSD switch mount and turn on the controller to enter the "Programming mode". Choose "Set Uart 1 to CN1" Input Port shown below :

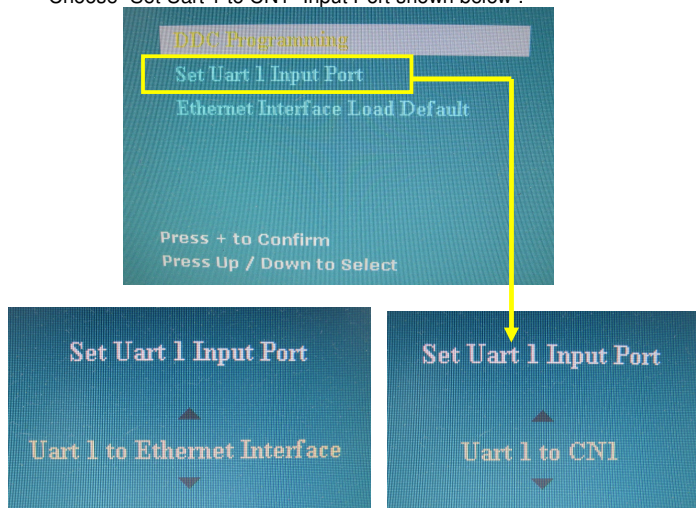

Set "Uart 1 to Ethernet Interface" : Enable Ethernet network (J1) support and disable second RS-232 serial control (CN1) support

Set "Uart 1 to CN1" : Enable second RS-232 serial control (CN1) support. Disable Ethernet network (J1) support

Specifications subject to change without notice

12. **External panel power output** : User for specific panel model.
  13. **Panel control signal** : Use for specific panel model.
  14. **SPDIF Audio output** : This port support SPDIF audio output from the HDMI audio source inputted. (This port function is not implemented yet)
  15. **Ambient light sensor connection** : 3 ways connector provides interface for ambient light sensor connection by using Kit 70220-3.
  16. **Backlight status input** : 2 ways connector provides interface for connection with the specific panel type which support the panel with backlight status monitoring function.
  17. **DVI-D input cable** : Plug the DVI cable to the connector P2 on the controller board. This port is not supported when CN2 is connected.
  18. **HDMI input** : Plug the HDMI cable to the connector P3 on the controller board. This port is not supported when CN5 is connected.
  19. **Analog RGB Input** : As this may affect regulatory emission test results and the quality of the signal to the controller a suitably shielded cable should be utilized.
  20. **Component video input** : Plug the component video input cable P/N 426000600-3 on CNV2 connector
  21. **Alternate HDMI input** : This port gives alternate HDMI input support. This port is not support when P3 connector is connected. It allows to connect HD-1000 / HD-2000 / HD-3000S for SDI input, see Appendix VIII for the connection setup.
  22. **Alternate DVI-D input** : This port gives alternate DVI-D input support. This port is not supported when P2 connector is connected. It allows to connect HD-1000 / HD-2000 / HD-3000S for SDI input, see Appendix VIII for the connection setup.
  23. **AVD-1000 connection** : This port is for AVD-1000 video add on board connection. (Implemented start from V1.16.00.00 (U3) firmware or later version). See Appendix VIII for the connection setup.
  24. **Control over network connection** : This is a network device that allow to control RS-232 enable devices over a TCP/IP based Ethernet and the Internet using a web browser. Please refer to Appendix VII in details.
  25. **Audio add-on board P/N 416940020-3**: The audio add-on board gives the audio input and output signal connection. It is an optional part only, can be unconnected if not using audio. (This port function is not implemented yet)  
CAUTION : The Audio Add-on Board P/N 416940020-3 can only operate with 12VDC power input environment.
  26. **Audio extend cable** : The audio extend cable P/N 426009700-3 designs for connection between audio add on board P/N 416940020-3 and the controller. It is an optional part only, can be unconnected if not using audio.
  27. **Power Input**: 12VDC is required, this should be a regulated supply. The power rating is depending on the panel and inverter used. Normally, power supply with 3.5Amp current output should enough for most of 4x CCFT panels. Although the controller provides power regulation for the LCD power this does not relate to the power supplied to the backlight inverter. If an unregulated power supply is provided to an inverter any fluctuations in power may affect operation, performance and lifetime of the inverter and or backlight tubes.
  28. **External panel power input** : Allow to supply external power to the panel separately for max 3.3V (7A) or 5V (7A) or 12V (5A) or 18V (3.5A) via PP4 power input connector. Corresponding jumper setting of JA3, JA5 & JA6 are required for each panel power input by referring to page 17.
- **Power output**: Note the controller has an overall 3Amp current limit and the current available from the auxiliary power output will be dependent on the power input and other system requirements.
  - **Power Safety**: Note that although only 12VDC is required as 'power-in' a backlight inverter for panel backlighting produces significantly higher voltages (the inverter does not connect to the ground plane). We strongly advise appropriate insulation for all circuitry.
  - **EMI**: Shielding will be required for passing certain regulatory emissions tests. Also the choice of external Controller to PC signal cable can affect the result.
  - **Ground**: The various PCB mounting holes are connected to the ground plane.
  - **Servicing**: The board is not user serviceable or repairable. Warranty does not cover user error in connecting up to the controller and is invalidated by unauthorized modification or repairs.
  - **Controller Mounting**: It is recommended that a clearance of at least 10mm is provided above and 5mm below the controller when mounted. Additionally consideration should be given to:
    - Electrical insulation.
    - Grounding.
    - EMI shielding.

- Cable management. Note: It is important to keep panel signal cables apart from the inverter & backlight cables to prevent signal interference.
- Heat & Ventilation: Heat generated from other sources, for example the backlight of a very high brightness panel may generate significant heat which could adversely affect the controller.
- Other issues that may affect safety or performance.
- **PC Graphics Output:** A few guidelines:
  - Signal quality is very important, if there is noise or instability in the PC graphics output this may result in visible noise on the display.
  - Refer to graphics modes table in specifications section for supported modes.
  - Non-interlaced & interlaced video input is acceptable.

**IMPORTANT: Please read the Application Notes section for more information.**

---

## CONNECTION & OPERATION

**CAUTION:** Never connect or disconnect parts of the display system when the system is powered up as this may cause serious damage.

### CONNECTION

Connection and usage is quite straight forward (it is useful to have the relevant connection diagram available at this time):

1. **LCD panel & Inverter:** Connect the inverter (if it is not built-in the panel) to the CCFT lead connector of the LCD panel.
2. **LVDS type panels:** The controller board has the built-in LVDS transmitter driver. Plug the LVDS cable to J3. Insert the panel end of the cable the LCD panel connector.
3. **Inverter & Controller:** Plug the inverter cable to CNB1 and CNA1 (if necessary). Plug another end to the connector on the inverter.
4. **Function switch & Controller:** Plug the OSD switch mount cable to CNC1 on the controller board and another to the OSD switch mount.
5. **LED & Controller:** Plug in a 3-way with dual color LED to connector LED1 on the controller board.
6. **IR & Controller:** Plug in a 3-way with IR sensor to connector IR1 on the controller board.
7. **Jumpers & Switches:** Check all jumpers and switches (SW3, SW4) are set correctly. Details referring the connection diagram (a separate document) or the jumpers and switches setting table (in the following section).
8. **Jumpers & Inverter & Panel voltage:** Particularly pay attention to the settings of JA3, JA5, JA6, JB2 and JB3. JB2 & JB3 are used for inverter control (read inverter specification and information on the jumper table to define the correct settings). JA3 & JA5 & JA6 is used for panel voltage input (read panel specification and information on the jumper table to define the correct settings).
9. **Input signal cable & Controller:** Plug the corresponding signal input to the connector on the controller board.
10. **Power supply & Controller:** Plug the DC 12V power in to the connector PP5 or PP2. You can consider to use DigitalView mating power cable P/N 426013800-3, 160mm for PP5 connection.
11. **External panel power input :** Plug power cable : P/N 426013700-3 for external panel power input (3.3 (max 7A) / 5V (max 7A) / 12V (max 5A) / 18V (max3.5))
12. **Power on:** Switch on the controller board and panel by using the OSD switch mount.

General:

- If you are using supplied cables & accessories, ensure they are correct for the model of panel and controller.
- If you are making your own cables & connectors refer carefully to both the panel & inverter specifications and the section in this manual, "Connectors, Pinouts & Jumpers" to ensure the correct pin to pin wiring.

### PC SETTINGS

The controller has been designed to take a very wide range of input signals however to optimize the PC's graphics performance we recommend choosing 60Hz vertical refresh rate – this will not cause screen flicker.

### OPERATION

Once the system has been connected and switched on there are a number of functions available to adjust the display image as summarized in the following sections. The settings chosen will be saved for each mode independently.

### LCD DISPLAY SYSTEM SETTINGS

NOTE: By way of explanation the following refers to a set of sample buttons that may be obtained as an option. In addition to power on/off and connection for backlight brightness the controller provides an On Screen Display of certain functions which are controlled by 5 momentary type buttons (analog VR type) or 8 momentary type buttons (digital type):

Controls	Analog VR type	Digital type
On/Off – turns controller board power on	VR toggle switch	On/Off button
Brightness – controls backlight brightness	Rotary VR	Brightness +/- buttons
Menu – Turns OSD menu On or Off (it will auto time off) – Back to previous OSD menu page	Menu button	Menu button
Select down – Moves the selector to the next function (down)	SEL DN	SEL DN
Select up – Moves the selector to the previous function (up)	SEL UP	SEL UP
+ – Increase the OSD parameter values – Go into the sub-menu page from the top – Confirm to select the OSD function	+	+
- – Decrease the OSD parameter values – Go into the sub-menu page from the bottom	-	-
Reset to Factory Defaults	Press and hold SEL DN button, then power on the controller	Press and hold SEL DN button, then power on the controller
Access "Programming Mode"	Press and hold MENU button, then power on the controller	Press and hold MENU button, then power on the controller

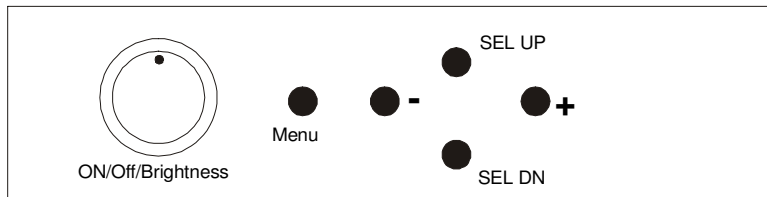

Analog VR type

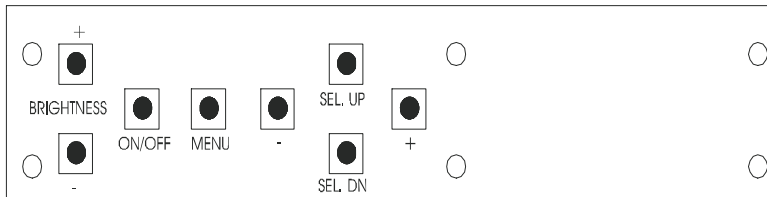

Digital type



## OSD functions



### Picture :

Brightness		Increase/decrease panel brightness level, total: 100 steps
Contrast		Increase/decrease panel contrast level, total: 100 steps
Saturation		Increase/decrease saturation, total: 100 steps
Hue **		Increase/decrease Hue level, total: 100 steps
Sharpness*		Increase/decrease sharpness, total: 30 steps
Backlight		Backlight brightness adjustment (Functions when light detector sets OFF)

### Position##



Move the image position upward



Move the image position downward



Move the image position to the left



Move the image position to the right

### Aspect / Size ▶











- Fill Screen : Enable full screen expansion for lower resolution Image
- Fill to Aspect Ratio: Enable fill screen expansion for lower resolution image according to aspect ratio
- 4 : 3 : scaling format in 4:3
- 16 : 9 : scaling format in 16:9
- 16 : 10 : scaling format in 16:10
- 2.35 : 1 : scaling format in 2.35:1
- 2 : 1 : scaling format in 2:1
- 1 : 1 : Display the exact image resolution on the screen without image expansion.

\*\* : FUNCTION IN ARGB/ DVI / VIDEO NTSC MODE ONLY

# : DISPLAY IN ARGB / DVI MODE ONLY

## : FUNCTION IN ARGB MODE ONLY



- DVI 
- HDMI 
- Composite 1\* 
- Composite 2\* 
- S-Video 1\* 
- S-Video 2\* 
- SD Component 1\* 
- SD Component 2\* 
- HD/SD SDI 1\*\* 
- HD/SD SDI 2\*\* 
- Component 1 

The corresponding input port name display on OSD menu will disappear once setting "OFF".

Auto Power :  OFF / ON  
 ON – Enable soft power off function if absence of input signals  
 OFF – Disable soft power function

Anti Image Retention ▶

Anti Image Retention :  OFF / ON  
 Method : Flash / Pixel Shift / Horizontal Pan / Vertical Pan

- Flash : Flashing the screen
- Pixel Shift : Image shift pixel by pixel around the screen
- Horizontal Pan : Display a pattern moving horizontally on screen.
- Vertical Pan : Display a pattern moving horizontally on screen.

Horizontal Pan Setting :

- Height > Panel Height : ÷2 / ÷4 / ÷6 / ÷8 : Configure the pattern height
- Width > Panel Width : ÷2 / ÷4 / ÷6 / ÷8 : Configure the pattern width
- Pattern : Black / White : Configure the pattern color
- Pass : 1 ~ 100 : Configure the pattern moving cycle

Vertical Pan Setting :

- Height > Panel Height : ÷2 / ÷4 / ÷6 / ÷8 : Configure the pattern height
- Width > Panel Width : ÷2 / ÷4 / ÷6 / ÷8 : Configure the pattern width
- Pattern : Black / White : Configure the pattern color
- Pass : 1 ~ 100 : Configure the pattern moving cycle

Flash Setting :

- Timer : 1 ~ 100s : Configure the flashing duration
- Flash Period : 1 ~ 100 : Configure the flashing cycle
- Note : Anti Image retention state will be cleared once you press the MENU button.

Image Orientation\*\* ▶

- Normal
- Horizontal Flip
- Vertical Flip
- Rotate

OSD ▶

OSD position :



Move the OSD menu image position upward



Move the OSD menu position downward



Move the OSD menu position to the left





Move the OSD menu position to the right

OSD Timeout (sec) : ON – 60 : Adjust the OSD menu timeout period in a step of 5 seconds (max 60 seconds)  
 ON = Continuous to display OSD menu.  
 60 = 60 seconds later will turn off the OSD menu.

Language : English / Spanish / French / German / Chinese :Select OSD menu language display

Display Input :  OFF / ON : Display input source info after switching source.

IR Remote control : IR Remote Enable : Set enable on IR remote control

IR Remote Disable : Set disable on IR remote control  
 Real time clock## ▶ show and edit the real time clock (This function is valid when "Display Input" sets ON.)  
 DATE : DD/MM/YYYY : Date/Month/Year  
 TIME : HH/MM/SS (AM/PM): Hour/Minute/Second  
 SETUP ▶  
 Month / Day / Year  
 Hour / Minute / AM/PM  
 Display Clock   : Disable or enable to display the real time clock when display video source info after switching source.

**Freeze** : Freeze the image (use "+" button)

**Zoom** ▶

Zoom level :  : Enable the zoom in function on the image displayed.  
 Use "+" button to zoom in the image  
 Use "-" button to decrease the zoomed image

Horizontal pan :  : Pan the image horizontally

Vertical pan :  : Pan the image vertically

Factory Reset

Note : Freeze state will be cleared when you using zoom function.

**Color Temperature** ▶

5000K

Red Gain : 

Green Gain : 

Blue Gain : 

Red Offset : 

Green Offset : 

Blue Offset : 

Reset to Defaults : Resume to the default values

6500K

Red Gain : 

Green Gain : 

Blue Gain : 

Red Offset : 

Green Offset : 

Blue Offset : 

Reset to Defaults : Resume to the default values

8000K

Red Gain : 

Green Gain : 

Blue Gain : 

Red Offset : 

Green Offset : 

Blue Offset : 

Reset to Defaults : Resume to the default values

9300K

Red Gain : 

Green Gain : 

Blue Gain : 

Red Offset : 

Green Offset : 

Blue Offset : 

Reset to Defaults : Resume to the default values

User setting :

Red Gain : 

Green Gain : 

Blue Gain : 

Red Offset : 

Green Offset : 

Blue Offset : 

Reset to Defaults : Resume to the default values



Reset All to Defaults : Resume all color temperature settings to the default values.

#### Hot Key ▶

Hot key 1 : Brightness / Contrast / Inputs / Aspect Ratio/ Zoom / Freeze / PIP Size / PIP Swap / PIP ON/OFF / Saturation / Hue / Backlight / Auto Picture Setup / No Function

Hot key 2 : Brightness / Contrast / Inputs / Aspect Ratio/ Zoom / Freeze / PIP Size / PIP Swap / PIP ON/OFF / Saturation / Hue / Backlight / Auto Picture Setup / No Function

#### Backlight Setup ▶

- B/L Invert :  : Invert for the backlight brightness
- B/L Control : D/A / PWM : Selection for voltage level dimming control / PWM dimming control
- Backlight Frequency :  100 ~ 440Hz in a step of 20
- Light Detector :  : Enable ambient light detector function by using KIT 70220-3
- Min Backlight Level : 0 ~ 50% : Default the minimum backlight adjustment.

#### Default Setting ▶

Reset to Factory Defaults ▶ (Activate when JC1 position 4 sets open)

Are you sure ? Yes/No

Reset to Factory Defaults with (Color Temp.) ▶ (Activate when JC1 position 4 sets open)

Are you sure ? Yes/No

Save Current Settings as Calibrated Values ▶ (Activate when JC1 position 2 sets closed)

Are you sure ? Yes/No

Recall Stored Calibrated Values ▶

Are you sure ? Yes/No

# : DISPLAY IN ARGB MODE ONLY  
## : DISPLAY WHEN THE REAL TIME CLOCK CIRCUIT ON BOARD ONLY  
+ DISPLAY IN ARGB & COMPONENT MODE ONLY  
++ DISPLAY WHEN HD-1000/-2000/-3000S CONNECTED  
\*\* DISPLAY WHEN AVD-1000 CONNECTED

\* The image orientation function is not support under the following conditions :

- PIP
- Component 1 (via CNV2 connector) input.
- Driving with 1366x768 panel
- Zoom

Firmware V0.16.00.00 or up

## CONNECTORS, PINOUTS & JUMPERS

The various connectors are:

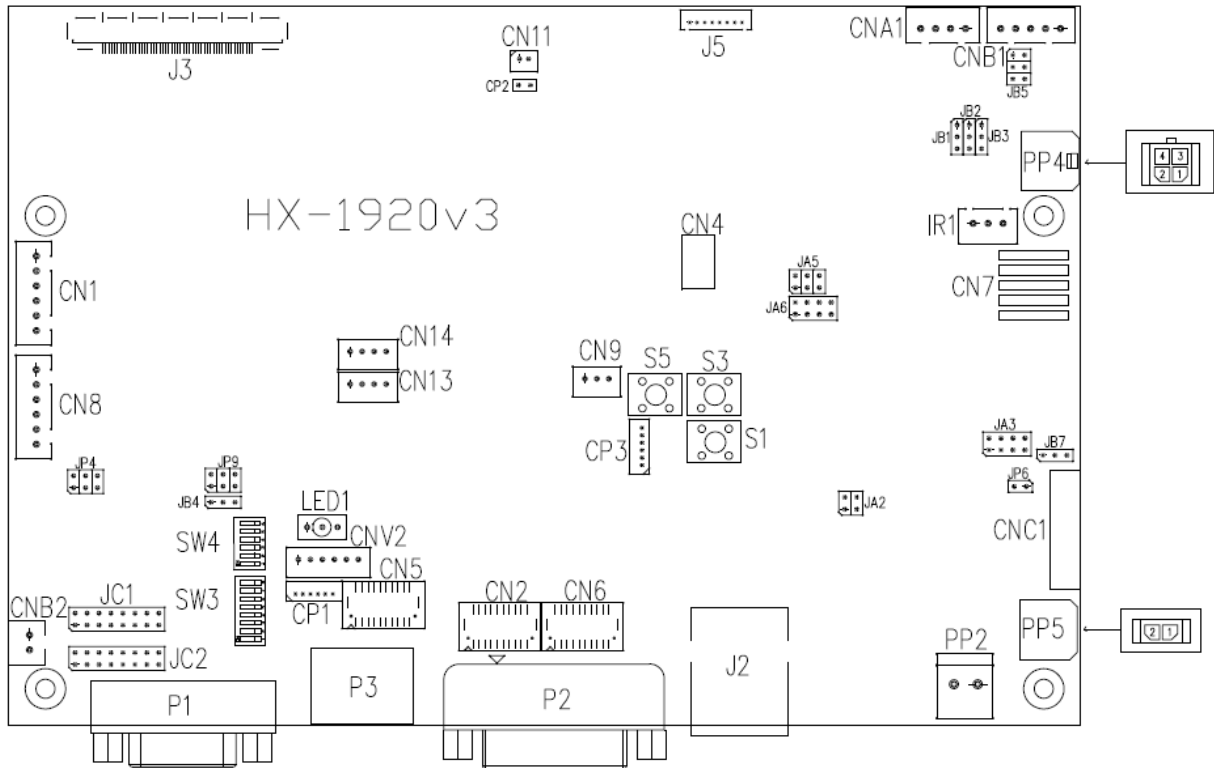

### Summary: Connectors

Ref	Purpose	Description
CN1	Reserved for second RS-232 serial control	JST 6-way, B6B-XH-A (Matching type : XHP-6)
CN2	Alternate DVI connector	JST BM20B-SRDS (Matching type : SHDR-20V-S-B)
CN4	Panel control signal connector	Hirose 10-pin, DF20G-10DP-1V (Matching type : DF20A-10DS-1C)
CN5	Alternate HDMI connector	JST BM20B-SRDS (Matching type : SHDR-20V-S-B)
CN6	Auxiliary digital input connector (for AVD-1000 connection only)	JST BM20B-SRDS (Matching type : SHDR-20V-S-B)
CN7	Reserved for Audio board connector	Dual pin header 5x2, 0.1" pitch right angle (Matching audio add-on board P/N 416940020-3 & Audio extend cable P/N 426009700-3)
CN8	RS-232 serial control	JST 6-way, B6B-XH-A (Matching type : XHP-6)
CN9	Ambient light sensor connector	JST 3-way, B3B-PH-K (Matching type : PHR-3)
CN11	SPDIF Audio output	JST B2B-ZR (Matching type : ZHR-2) (Matching extend cable P/N 426007400-3)
CN13	Reserved for Speaker (Stereo) in	JST B4B-ZR (Matching type : PHR-4)
CN14	Reserved for Speaker (Stereo) out	JST B4B-ZR (Matching type : PHR-4)
CNA1	Auxiliary power output	JST 4-way, B4B-XH-A (Matching type : XHP-4) (Matching cable P/N 426040200-3)
CNB1	Backlight inverter	JST 5-way, B5B-XH-A (Matching type : XHP-5) (Matching cable P/N 426058300-3)
CNB2	Backlight status input connector	JST 2 way, B2B-XH-A (Matching type : XHP-2)
CNC1	OSD control	Hirose DF13A-12P-1.25H (Mating type : DF13-12S-1.25C) (Matching OSD switch mount cable P/N 426122200-3 (150mm) or 426122210-3 (250mm))
CNV2	Component (YPbPr) video input connector	JST 6-way, B6B-PH-K (Matching type : PHR-6)
CP1	Reserved for internal programming	Reserved
CP2	Reserved	Reserved
CP3	Reserved for internal programming	Reserved
IR1	Infra-red sensor connector	JST 3-way, B3B-XH-A (Matching type : XHP-3)
J2	Ethernet	RJ-45 connector
J3	LVDS panel signal output 2	JAE FI-RE51S-HF (Matching type : FI-RE51HL)
J5	Panel power output	JS-1147A-08 Top 1.25mm (Matching type : JS-1146-08)

Specifications subject to change without notice

P1	VGA	DB-15 way high density 3 row
P2	DVI-D	DVI-D connector
P3	HDMI	HDMI connector
PP2	Power input (alternative)	DC power Molex 2 pin 0.156" pitch
PP4	External panel power input	Molex 43045-0400 compatible (Matching connector type : Molex 43025-0400 compatible) (Matching power cable : P/N 426013700-3)
PP5	Power input	Molex 43650-0200 compatible (Matching connector type : Molex 43645-0200 compatible) (Matching power cable : P/N 426013800-3)
S1	Reset button (for Ethernet function)	Tact switch button
S3	Reserved	Tact switch button
S5	Config Menu button (for Ethernet function)	Tact switch button
SW3	Panel selection	8-way DIP Switch
SW4	Function selection	6-way DIP Switch

**Summary: Jumpers setting**

Ref	Purpose	Note
JA2	On board +3.3V logic power enable	1-2 & 3-4 closed, factory set, do not remove
JA3	Panel power voltage select <b>CAUTION:</b> Incorrect setting can damage panel	See panel voltage setting table 1
JA5	Panel power voltage select <b>CAUTION:</b> Incorrect setting will cause panel damage	See panel voltage setting table 1
JA6	Panel power voltage select <b>CAUTION:</b> Incorrect setting will cause panel damage	See panel voltage setting table 1
JB1	Backlight brightness voltage range	1-2 closed = 5V max 2-3 closed = 3.3V max
JB2	Backlight inverter on/off control – signal level	2-3 = On/Off control signal 'High' = +5V 1-2 = On/Off control signal 'High' = +3.3V Open = On/Off control signal 'High' = Open collector <b>CAUTION:</b> Incorrect setting can damage inverter.
JB3	Backlight inverter on/off control – polarity	1-2 = control signal 'high' = CCFT ON 2-3 = control signal 'low' = CCFT ON
JB4	GPIO pins voltage selection	1-2 = 3.3V 2-3 = 5V
JB5	Backlight control type selection	1-2 = VR/Digital switch mount control 3-4 = Analog backlight brightness - voltage range 0~5V 5-6 = PWM (Pulse Width Modulation) brightness
JB7	Backlight control voltage on CNB1 pin 4  (Function when JB5 sets 1-2 closed)	Open = For OSD switch mount control (Default) 1-2 = 0V 2-3 = 3.3V / 5V controlled by JB1
JC1	Custom configuration	Position 1 : Closed = Disable B/L setup menu  Position 2 : Closed = Enable save Current Settings as Calibrated Values on OSD menu  Position 3 : Closed = Enable baud rate selection function in programming mode  Position 4 : Closed = Hide "Reset to Factory Defaults" and "Reset to Factory Defaults with (Color Temp.)" from OSD menu.  Position 7 : Closed = Enable for selection of the "RM-DN5 Assembly" menu on Programming mode.
JC2	Custom configuration	Position 1 : Enable J3 – pin 16 (OP1) controlled by JB4 Position 2 : Enable J3 – pin 17 (OP2) controlled by JB4
JP4	Custom configuration	1-2 closed = Reserved 3-4 closed = On-board programming 5-6 closed = Reserved
JP6	Input power control	Short = External switch control Open = Switch mount control
JP9	Factory use	Default Open
SW3	Panel & function selection	See table 2
SW4	Panel & function selection	See table 3



**Table 1 : Panel voltage setting table :**

Input voltage via PP2/PP5	Panel Voltage	JA3	JA5	JA6	Jumper on board
12VDC	3.3V	3V3 closed	1-3 & 2-4	1-3 & 2-4	
	5V	5V closed	1-3 & 2-4	1-3 & 2-4	
	12V	OPEN	1-3 & 2-4	5-7 & 6-8	

**CAUTION: Incorrect setting can damage panel & controller**

Input voltage via PP4	Input voltage via PP2 / PP5	Panel Voltage	JA3	JA5	JA6	Jumper on board
3.3 / 5 / 12 / 18VDC*	12V DC	3.3V	OPEN	3-5 & 4-6	1-3 & 2-4	
		5V	OPEN	3-5 & 4-6	1-3 & 2-4	
		12V	OPEN	3-5 & 4-6	3-5 & 4-6	
		18V	OPEN	3-5 & 4-6	3-5 & 4-6	

\* Maximum current for 3.3V, 5V = 7A, Maximum current for 12V = 5A, Maximum current for 18V = 3.5A

**CAUTION: Incorrect setting can damage panel & controller**

JA3, JA5 & JA6 location on board : (Please pay attention to the jumper settings on JA3, JA5 & JA6 which are red in color)

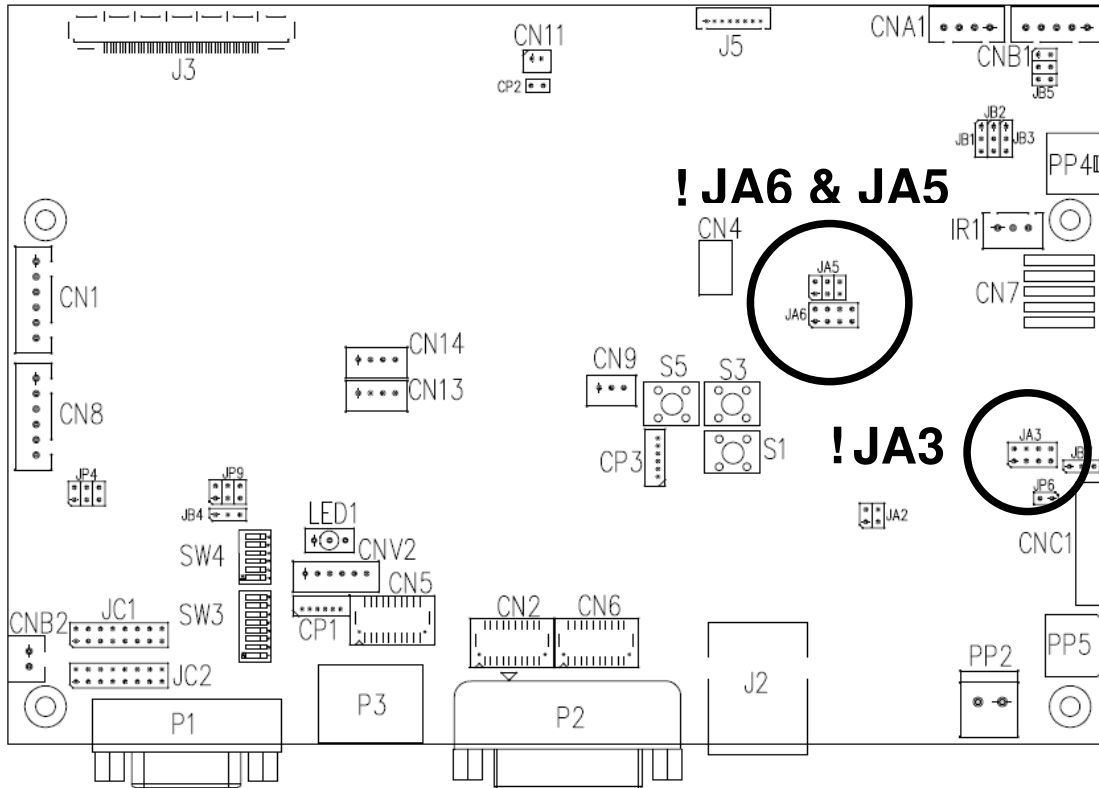

**Table 2 : DIP Switch selection – SW3**

Pos #1	Pos #2	Pos #3	Pos.#4	Description	Panel resolution
<b>For WUXGA panels</b>					
OFF	ON	ON	OFF	LG LM260WU1-SLB1/Samsung LTM220CS01	1920x1200
ON	ON	ON	OFF	LG LM240WU2-SLA1	1920x1200
OFF	OFF	OFF	OFF	Sharp LQ445D3LZ19	1920x1080
ON	OFF	OFF	OFF	Samsung LTA460H2-L02	1920x1080
OFF	ON	OFF	OFF	Sharp LQ170M1LZ04	1920x1200
ON	ON	OFF	OFF	Samsung LTA700HH-LH1 (1 <sup>st</sup> trial testing)	1920x1080
OFF	OFF	ON	OFF	Samsung LTA700HH-LH1 (2 <sup>nd</sup> trial testing)	1920x1080
OFF	OFF	ON	ON	AU Optronics P645HW03 V0 (1920x1080)	1920x1080
OFF	OFF	ON	ON	AU Optronics P645HW03 V0	1920x1080
<b>For UXGA panels</b>					
OFF	OFF	OFF	OFF	Fujitsu FLC59UXC8V-02A	1600x1200
ON	OFF	OFF	OFF	Samsung LTM213U6-L01	1600x1200
<b>For WXGA panels</b>					
OFF	OFF	OFF	OFF	LG LC420W02-A4	1366x768
ON	OFF	OFF	OFF	Sharp LQ315T3LZ24	1366x768
ON	ON	OFF	OFF	Samsung LTA320W2-L01 / LTA230W1-L02	1366x768
ON	ON	ON	ON	NEC NL12876BC26-21 / Samsung LTM170W1-L01	1280x768
OFF	ON	ON	ON	CHI MEI N154I4-L01	1280x800
OFF	OFF	ON	OFF	AU Optronics M190PW01	1440x900
OFF	OFF	ON	ON	Sharp LQ072K1LA03	1280x768
<b>For SXGA panel</b>					
OFF	OFF	OFF	OFF	Sharp LQ181E1LW31	1280x1024
ON	OFF	OFF	OFF	AU Optronics M170EN05	1280x1024
<b>For XGA panel</b>					
OFF	OFF	OFF	OFF	Sharp LQ150X1LGN2A / LQ150X1LGB1 AUO M150XN07V2	1024x768 1024x768
<b>For SVGA panel</b>					
OFF	OFF	OFF	OFF	Sharp LQ121S1DG11/41 Toshiba LTM08C351	800x600 800x600
<b>For WVGA panel</b>					
OFF	OFF	OFF	OFF	NEC NL8048BC24-01	800x480
ON	OFF	OFF	OFF	Kyocera TCG085WV1AB-G00	800x480
ON	OFF	ON	OFF	Sharp LQ070Y3LG4A	800x480
<b>For VGA panel</b>					
OFF	OFF	OFF	OFF	Sharp LQ104V1DG51	640x480
ON	OFF	OFF	OFF	Sharp LQ104V1DG21	640x480
ON	OFF	ON	OFF	Kyocera TCG075VG2AC-G00	640x480
<b>Others</b>					
OFF	ON	OFF	OFF	AU Optronics M201EW02 V8	1680x1050
ON	OFF	OFF	ON	Samsung LTM201M1-L01	1680x1050
OFF	OFF	ON	OFF	Samsung LTI430LA01	1920x480
OFF	ON	ON	OFF	NEC NL10260BC19-01D	1024x600
ON	ON	ON	OFF	AU Optronics M200RW01 Samsung LTM200KP01	1600x900 1600x900

**Remark : The above panel timings are generated based on the panel specification. Some of the panel timings settings may not exactly to match the panel model we specified in this table.**

Pos #5	Pos #6	Pos #7	Description
OFF	OFF	OFF	WUXGA
ON	OFF	OFF	UXGA
OFF	ON	OFF	SXGA
ON	ON	OFF	WXGA
OFF	OFF	ON	XGA
ON	OFF	ON	SVGA
OFF	ON	ON	VGA
ON	ON	ON	WVGA / Others

Pos. #8	Video lock	ON – Disable : The output refresh rate locks to the input for 50Hz / 60Hz mode (other resolution lock the output be 60Hz. )  OFF – Enable : Always fix the output be 60Hz.
---------	------------	--

**Table 3 : DIP switch selection – SW4**

Pos. #	Function	Description
1	Reserved	
2	Panel pixel format	OFF : Double Pixel ON : Single Pixel
3	Panel selection	ON : LVDS panel OFF : Reserved
4	LVDS data mapping select (Refer to Table 2)	If SW4 position 5 = OFF (8 bit) OFF : Mapping B ON : Mapping A Please adjust to get the correct picture. See as Appendix III for details of mapping of A and B. If SW4 position 5 = ON (10 bit) OFF : JEIDA (LVDS panel) ON : VESA (LVDS panel) Please adjust to get the correct picture. See as Appendix III for details of mapping of VESA and JEIDA.
5	Output LVDS display mode selection	OFF : 8 bit ON : 10 bit
6	Reserved	

**CN1 – Slave RS-232 serial control: JST B6B-XH-A (Matching type : XHP-6)**

PIN	SYMBOL	DESCRIPTION
1	EXT_MSTR2_SCL	Reserved
2	EXT_MSTR2_SDA	Reserved
3	VCC	+5V
4	TXD	RS-232 Tx data
5	GND	Ground
6	RXD	RS-232 Rx data

**CN2 – Alternate DVI connector: JST BM20B-SRDS (Matching type : SHDR-20V-S-B)**

PIN	SYMBOL	DESCRIPTION
1	GND	Digital Ground
2	GND	Digital Ground
3	RXC	TMDS Clock+
4	/RXC	TMDS Clock-
5	RX0	TMDS Data 0+
6	/RX0	TMDS Data 0-
7	RX1	TMDS Data 1+
8	/RX1	TMDS Data 1-
9	RX2	TMDS Data 2+
10	/RX2	TMDS Data 2-
11	GND	Ground (+5, Analog H/V Sync)
12	GND	Digital Ground
13	EXT_MSTR2_SCL	Reserved
14	EXT_MSTR2_SDA	Reserved
15	DDC_5V	+5V power supply for DDC (optional)
16	HPD	Hot plug detect
17	DDC_CLK	DDC Clock
18	DDC_DAT	DDC Data
19	NC	No connection
20	GND	Ground

**CN4 – Panel connector: HIROSE DF20G-10DP-1V (Matching type : DF20A-10DS-1C)**

PIN	SYMBOL	DESCRIPTION
1	OP1	Reserved
2	OP2	Reserved
3	OP3	Reserved
4	OP4	Reserved
5	IP1	Reserved
6	IP2	Reserved
7	IP3	Reserved
8	IP4	Reserved
9	EXT_MSTR2_SDA	Reserved
10	EXT_MSTR2_SCL	Reserved

**CN5 - Alternate HDMI connector : JST BM20B-SRDS (Matching type : SHDR-20V-S-B)**

PIN	SYMBOL	DESCRIPTION
1	GND	Ground
2	GND	Ground
3	RXC+	TMDS Data C+
4	RXC-	TMDS Data C-
5	RX0+	TMDS Data 0+
6	RX0-	TMDS Data 0-
7	RX1+	TMDS Data 1+
8	RX1-	TMDS Data 1-
9	RX2+	TMDS Data 2+
10	RX2-	TMDS Data 2-
11	GND	Ground
12	GND	Ground
13	MSTR2_SCL	Reserved
14	MSTR2_SDA	Reserved
15	DDC_5V	+5V power supply for DDC (optional)
16	HPD	Hot plug detection
17	DDC_SCL	DDC serial clock
18	DDC_SDA	DDC Data
19	CEC	Consumer Electronics Control(CEC) pin
20	VCC2	VCC 5V output

**CN6 - Auxiliary Digital input connector : JST BM20B-SRDS (Matching type : SHDR-20V-S-B)**

PIN	SYMBOL	DESCRIPTION
1	GND	Ground
2	GND	Ground
3	RXC+	TMDS Data C+
4	RXC-	TMDS Data C-
5	RX0+	TMDS Data 0+
6	RX0-	TMDS Data 0-
7	RX1+	TMDS Data 1+
8	RX1-	TMDS Data 1-
9	RX2+	TMDS Data 2+
10	RX2-	TMDS Data 2-
11	GND	Ground
12	GND	Ground
13	MSTR2_SCL	Reserved
14	MSTR2_SDA	Reserved
15	DDC_5V	+5V power supply for DDC (optional)
16	HPD	Hot plug detection
17	DDC_SCL	DDC serial clock
18	DDC_SDA	DDC Data
19	NC	No connection
20	VCC2	VCC 5V output

**CN8 – RS-232 serial control: JST B6B-XH-A (Matching type : XHP-6)**

PIN	SYMBOL	DESCRIPTION
1	EXT_MSTR2_SCL	Reserved
2	EXT_MSTR2_SDA	Reserved
3	VCC	+5V
4	TXD	RS-232 Tx data
5	GND	Ground
6	RXD	RS-232 Rx data

**CN9 – Ambient light sensor connector : JST B3B-PH-K (Matching type : PHR-3)**

PIN	SYMBOL	DESCRIPTION
1	GND	Ground
2	VCC_5V	VCC 5V
3	ALSF	Ambient light sensing feedback

**CN11 – SPDIF audio output connector : JST B3B-PH-K (Matching type : PHR-3)**

PIN	SYMBOL	DESCRIPTION
1	SPDIF	SPDIF Digital audio output
2	GND	Ground

**CNA1 - Auxiliary power output: JST B4B-XH-A (Matching type : XHP-4)**

PIN	SYMBOL	DESCRIPTION
1	AUX 12V	+12V DC, 500mA max
2	GND	Ground
3	GND	Ground
4	AUX 5V	+5V DC, 500mA max

**CNB1 – Backlight inverter connector: JST B5B-XH-A (Matching type : XHP-5)**

PIN	SYMBOL	DESCRIPTION
1	GND	Ground
2	VBKL	+12V DC, backlight power supply
3	BLCTRL	On/Off control (enable) – see JB2 & JB3
4	BVR_WIP	Brightness VR – WIP
5	BVR_A	Brightness VR A

**CNC1 – OSD switch mount control, Hirose DF13A-12P-1.25H (Mating type : DF13-12S-1.25C)**

PIN	SYMBOL	DESCRIPTION
1	PSWIN	Power button A
2	SW_ON	Power button B
3	BVR_A	Backlight Brightness VR pin A
4	BVR_WIP	Backlight Brightness R pin WIP
5	BVR_B	Backlight Brightness VR pin B (470 ohm resistor to +5V Vcc)
6	GND	Ground
7	MENU	OSD menu
8	-/LEFT	OSD -/Left
9	+ /RIGHT	OSD +/Right
10	SEL_DN	OSD Select down

Specifications subject to change without notice

11	SEL_UP	OSD Select up
12	NC	No connection

The VR for brightness depends on the inverter. The main power load for On/Off is handled by a relay on the controller.

**CNV2 – Component (YPbPr) video input connector: JST 6-way, B6B-PH-K (Matching type : XHP-6)**

PIN	SYMBOL	DESCRIPTION
1	A Y1	Luma in / Green in
2	GND	Ground
3	A CB1	Cb in / Blue in
4	GND	Ground
5	A CR1	Cr in / Red in
6	GND	Ground

**IR1 – Infra-Red sensor connector: JST B3B-XH-A (Matching type : XHP-3)**

PIN	SYMBOL	DESCRIPTION
1	GND	Ground
2	STDBY_Vcc	Stand by voltage
3	IR Data	IR data

**J3 – LVDS output connector: JAE FI-RE51S-HF (Matching type : JAE FI-RE51HL)**

PIN	SYMBOL	DESCRIPTION
1	VDD (+12/18V)	Panel power supply (+12/18V) (selected by JA3, JA5 & JA6)
2	VDD (+12/18V)	Panel power supply (+12/18V) (selected by JA3, JA5 & JA6)
3	VDD (+12/18V)	Panel power supply (+12/18V) (selected by JA3, JA5 & JA6)
4	VDD (+12/18V)	Panel power supply (+12/18V) (selected by JA3, JA5 & JA6)
5	VDD (+12/18V)	Panel power supply (+12/18V) (selected by JA3, JA5 & JA6)
6	VDD (3,3V/5V)	Panel power supply (3,3V/5V) (selected by JA3, JA5 & JA6)
7	VDD (3,3V/5V)	Panel power supply (3,3V/5V) (selected by JA3, JA5 & JA6)
8	VDD (3,3V/5V)	Panel power supply (3,3V/5V) (selected by JA3, JA5 & JA6)
9	VDD (3,3V/5V)	Panel power supply (3,3V/5V) (selected by JA3, JA5 & JA6)
10	VDD (3,3V/5V)	Panel power supply (3,3V/5V) (selected by JA3, JA5 & JA6)
11	GND	Ground
12	GND	Ground
13	GND	Ground
14	GND	Ground
15	GND	Ground
16	OP1	-
17	OP2	-
18	NC	No function
19	NC	No function
20	GND	Ground
21	GND	Ground
22	TXA4+	Positive differential LVDS data bit A4
23	TXA4-	Negative differential LVDS data bit A4
24	TXA3+	Positive differential LVDS data bit A3
25	TXA3-	Negative differential LVDS data bit A3
26	GND	Ground
27	TXAC+	Positive LVDS clock for A channel
28	TXAC-	Negative LVDS clock for A channel
29	GND	Ground
30	TXA2+	Positive differential LVDS data bit A2
31	TXA2-	Negative differential LVDS data bit A2
32	TXA1+	Positive differential LVDS data bit A1
33	TXA1-	Negative differential LVDS data bit A1
34	TXA0+	Positive differential LVDS data bit A0
35	TXA0-	Negative differential LVDS data bit A0
36	GND	Ground
37	TXB4+	Positive differential LVDS data bit B4
38	TXB4-	Negative differential LVDS data bit B4
39	TXB3+	Positive differential LVDS data bit B3
40	TXB3-	Negative differential LVDS data bit B3
41	GND	Ground
42	TXBC+	Positive LVDS clock for B channel
43	TXBC-	Negative LVDS clock for B channel
44	GND	Ground
45	TXB2+	Positive differential LVDS data bit B2
46	TXB2-	Negative differential LVDS data bit B2
47	TXB1+	Positive differential LVDS data bit B1
48	TXB1-	Negative differential LVDS data bit B1
49	TXB0+	Positive differential LVDS data bit B0
50	TXB0-	Negative differential LVDS data bit B0
51	GND	Ground

Specifications subject to change without notice

**J5 – Panel power output connector: Molex 53261-0871, (Matching type : 51021-0800)**

PIN	SYMBOL	DESCRIPTION
1	VDD (3.3V/5V)	Panel power supply (3.3V/5V)
2	VDD (3.3V/5V)	Panel power supply (3.3V/5V)
3	GND	Ground
4	GND	Ground
5	GND	Ground
6	VDD (12V/18V)	Panel power supply (12V/18V)
7	VDD (12V/18V)	Panel power supply (12V/18V)
8	VDD (12V/18V)	Panel power supply (12V/18V)

**LED1 – Status LED connector: 3-pin header**

PIN	DESCRIPTION
1	Green LED pin (anode)
2	LED pin common (cathode)
3	Red LED pin (anode)

**P1 - Analog VGA in - 15 way connector**

PIN	SYMBOL	DESCRIPTION
1	PCR	Red, analog
2	PCG	Green, analog
3	PCB	Blue analog
4	ID2	Reserved for monitor ID bit 2 (grounded)
5	DGND	Digital ground
6	AGND	Analog ground red
7	AGND	Analog ground green
8	AGND	Analog ground blue
9	DDC_5V	+5V power supply for DDC (optional)
10	DGND	Digital ground
11	ID0	Reserved for monitor ID bit 0 (grounded)
12	DDC_SDA	DDC serial data
13	HS_IN	Horizontal sync or composite sync, input
14	VS_IN	Vertical sync, input
15	DDC_SCL	DDC serial clock

**P2 – DVI-D in**

PIN	SYMBOL	DESCRIPTION
1	/RX2	TMDS Data 2-
2	RX2	TMDS Data 2+
3	GND	Digital Ground
4	NC	No connection
5	NC	No connection
6	DDC_CLK	DDC Clock
7	DDC_DAT	DDC Data
8	NC	No connection
9	/RX1	TMDS Data 1-
10	RX1	TMDS Data 1+
11	GND	Digital Ground
12	NC	No connection
13	NC	No connection
14	DDC_5V	+5V power supply for DDC (optional)
15	GND	Ground (+5, Analog H/V Sync)
16	HPD	Hot Plug Detect
17	/RX0	TMDS Data 0-
18	RX0	TMDS Data 0+
19	GND	Digital Ground
20	NC	No connection
21	NC	No connection
22	GND	Digital Ground
23	RXC	TMDS Clock+
24	/RXC	TMDS Clock-
C1	NC	No connection
C2	NC	No connection
C3	NC	No connection
C4	HS_IN	Analog horizontal sync
C5	GND	Ground
C6	NC	No connection



**P3 – HDMI connector**

PIN	SYMBOL	DESCRIPTION
1	DATA2+	TMDS Data2+
2	DATA2S	TMDS Data2 Shield
3	DATA2-	TMDS Data2-
4	DATA1+	TMDS Data1+
5	DATA1S	TMDS Data1 Shield
6	DATA1-	TMDS Data1-
7	DATA0+	TMDS Data0+
8	DATA0S	TMDS Data0 Shield
9	DATA0-	TMDS Data0-
10	CLK+	TMDS Clock+
11	CLK@	TMDS Clock Shield
12	CLK-	TMDS Clock-
13	CEC	CEC
14	NC	No connection
15	SCL	SCL (I <sup>2</sup> C Serial Clock for DDC)
16	SDA	SDA (I <sup>2</sup> C Serial Data Line for DDC)
17	CEC/GND	Ground
18	+5V	+5 V Power (max 50 mA)
19	HPDET	Hot Plug Detect

**PP2 – Alternate 12VDC input power supply**

PIN	DESCRIPTION
1	+12VDC in
2	Ground

**PP4 – External panel power input**

PIN	DESCRIPTION
1	External panel power
2	Ground
3	External panel power
4	Ground

**PP5 – 12VDC input power supply**

PIN	DESCRIPTION
1	+12VDC in
2	Ground



## APPLICATION NOTES

### USING THE CONTROLLER WITHOUT BUTTONS ATTACHED

This is very straightforward:

- Firstly setup the controller/display system with the buttons. With controls attached and display system active make any settings for colour, tint and image position as required then switch everything off.
- Remove the control switches, the 12-way (CNC1) cable.
- Use a jumper or similar to connect pins 1 & 2 on CNC1, this will fix the board On.
- Refer to inverter specifications for details as to fixing brightness to a desired level, this may require a resistor, an open circuit or closed circuit depending on inverter.

**Summary:** On CNC1 the only pins that are used are for On/Off and Brightness (if controller mounted inverter is used). On CNC1 the pins are for momentary type buttons so it doesn't matter that no buttons are attached.

### INVERTER CONNECTION

There are potentially 3 issues to consider with inverter connection:

- Power
- Enable
- Brightness

Please read the following sections for a guide to these issues.

**Inverter Power:** As per the table for CNB1 pin 1 is ground and pin 2 provides 12V DC. This should be matched with the inverter specification: see table.

CNB1	
PIN	DESCRIPTION
1	Ground
2	+12VDC

Remark: For higher power inverter, more current (for 12V) can be taken from CNA1 pin 1.

**Enable:** This is a pin provided on some inverters for On/Off function and is used by this panel controller for VESA DPMS compliance. If the inverter does not have an enable pin or the enable pin is not used then DPMS will not be operational. Pin 3 should be matched to the inverters specification for the 'enable' or 'disable' pin.

CNB1	
PIN	DESCRIPTION
3	Enable

Further, jumpers JB2 & JB3 should be set to match the inverters specification for the enable pin power and High or Low setting: see table.

Ref	Purpose	Note
JB2	Inverter enable voltage	1-2 H = 3.3V, 2-3 H = 5V (Vcc), OPEN H = open collector
JB3	Inverter control	1-2 H = On, 2-3 L = On

**Brightness:** There are various methods for brightness control and it is important to consider the specifications for the inverter to be used. Generally the situation is:

- Brightness can control by using a resistor or VR (Variable Resistor).
- Brightness controlled by adding a circuit such as PWM (Pulse Width Modulation).
- No adjustment of brightness is possible.

CNB1 pins 4 & 5 are available for connecting to an inverter or circuit where VR control is supported.

CNB1	
PIN	DESCRIPTION
4	VR WIP
5	VR A

This can then be matched with function controls connected to CNC1 pins 4 & 3 or 5: see table.

CNC1	
PIN	DESCRIPTION
3	VR A
4	VR WIP
5	VR B

**Design Guideline for making VR circuitry :**

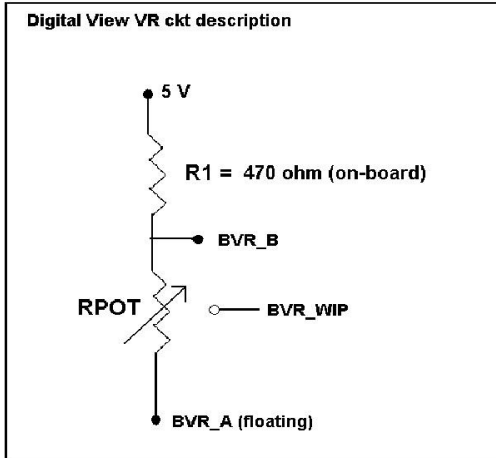

**Signal description / Notes :**

- 1) R1 : 470ohm on board
- 2) RPOT is an external potentiometer (in-line dip style) that can be plugged directly into CNC1 pins 3,4,5. RPOT must be supplied / installed by user.
- 3) BVR\_B : Voltage tapped from “top” of potentiometer, the node of R1 and RPOT.
- 4) BVR\_WIP : Voltage tapped from wiper arm of RPOT.
- 5) BVR\_A : Voltage tapped from “bottom” of RPOT.

**Note : BVR\_A voltage is left floating on the controller board. To use this circuit, you need to tie this point to a potential (usually GND, available at CNC1 pin 6).**

**CNB1 – Backlight inverter connector: JST B5B-XH-A (Matching type : XHP-5)**

PIN	SYMBOL	DESCRIPTION
1	GND	Ground
2	VBKL	+12VDC, backlight power supply
3	BLCTRL	On/Off control (enable) – see JB2 & JB3
4	BVR_WIP	Brightness VR - WIP
5	BVR_A	Brightness VR A

**CNC1 – Control switch, JST B12B-XH-A (Matching type : XHP-12)**

PIN	SYMBOL	DESCRIPTION
1	PSWIN	Power button A
2	SW_ON	Power button B
3	BVR_A	Backlight Brightness VR pin A
4	BVR_WIP	Backlight Brightness R pin WIP
5	BVR_B	Backlight Brightness VR pin B (470 ohm resistor to +5V Vcc)
6	GND	Ground
7	MENU	OSD menu
8	-/LEFT	OSD -/Left
9	+ /RIGHT	OSD +/Right
10	SEL_DN	OSD Select down
11	SEL_UP	OSD Select up
12	NC	No connection

The VR for brightness depends on the inverter. The main power load for On/Off is handled by a relay on the controller.

**Example for circuit design :**

- 1.) Choose RPOT = 10K
- 2.) Tie BVR\_A to GND
- 3.) Circuit analysis gives BVR\_WIP as the following (see Figure 1)

$$BVR\_WIP = 5 \times (Rbc/10.47)$$

where BVR\_WIP is in Volts.  
And Rbc is the resistance from the wiper arm to bottom of pot in Kohms.

To evaluate, plug in different values of Rbc :

Rbc	BVR_WIP
0	0 V
2.5 K	1.2 V
5 K	2.4 V
7.5 K	3.6 V
10 K	4.8 V

So this circuit could provide Brightness adjust voltage ranging from 0V to 5V.

Specifications subject to change without notice

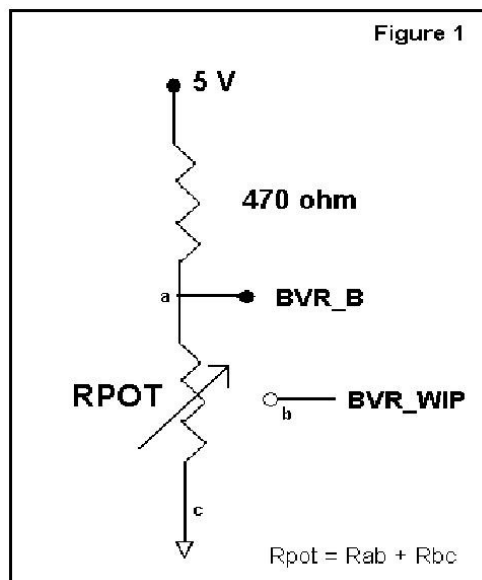

---

## TROUBLESHOOTING

### General

A general guide to troubleshooting a flat panel display system it is worth considering the system as separate elements, such as:

- Controller (jumpers, PC settings)
- Panel (controller, cabling, connection, panel, PC settings)
- Backlight (inverter, cabling, backlight tubes)
- Cabling
- Computer system (display settings, operating system)

Through step by step cross checking with instruction manuals and a process of elimination to isolate the problem it is usually possible to clearly identify the problem area.

### No image:

- If the panel backlight is not working it may still be possible to just see some image on the display.
- A lack of image is most likely to be caused by incorrect connection, lack of power, failure to provide a signal or incorrect graphic card settings.

### Image position:

If it is impossible to position the image correctly, i.e. the image adjustment controls will not move the image far enough, then test using another graphics card. This situation can occur with a custom graphics card that is not close to standard timings or if something is in the graphics line that may be affecting the signal such as a signal splitter (please note that normally a signal splitter will not have any adverse effect).

### Image appearance:

- A faulty panel can have blank lines, failed sections, flickering or flashing display
- Incorrect graphics card refresh rate, resolution or interlaced mode will probably cause the image to be the wrong size, to scroll, flicker badly or possibly even no image.
- Incorrect jumper settings on the controller may cause everything from total failure to incorrect image. CAUTION: Do not set the panel power input incorrectly.
- Sparkling on the display: faulty panel signal cable.
- Found "Loading" message displayed on screen message at HDMI / DVI input indicates the unstable HDMI/DVI source detected (especially connected to HDMI splitter) causing flashing image.

### Backlight:

Items to check include: Power input, Controls, Inverter and Tubes generally in this order.

If half the screen is dimmer than the other half:

- Check cabling for the inverter.
- For a specific backlight tube check the AC pins orientation (CAUTION: Never reverse any DC power pins).

Also:

- If adjusting brightness control has no effect the chances are that the VR rating or method of adjusting brightness is not compatible or correctly connected to the inverter.
- If system does not power down when there is a loss of signal

### Continued failure:

If unit after unit keeps failing consider and investigate whether you are short circuiting the equipment or doing something else seriously wrong.

Generally after common sense issues have been resolved we recommend step by step substitution of known working parts to isolate the problem.

## SPECIFICATIONS

Panel compatibility	Compatible with 1920x1200, 1920x1080, 1920x480, 1680x1050, 1600x1200, 1600x900, 1440x900, 1366x768, 1280x1024, 1280x800, 1280x768 1024x768, 1024x600, 800x600, 800x480 and 640x480 resolutions of TFT LCD panels.  A specified BIOS and some factory adjustment may be required for individual panel timings.
No. of colors	Up to 3 x 10 bit providing 1.06 billion colors.
Panel power	DC 3.3V, 5V, 12V, 18V
Panel signal	LVDS
Vertical refresh rate	60Hz at 1920x1200, 60Hz at 1920x1080, 60Hz at UXGA and up to 75Hz other lower resolution
Display clock maximum	165MHz
ADC clock maximum	195 MHz
DVI differential input clock maximum	165MHz
Graphics formats	Standard VESA VGA, SVGA, XGA, SXGA, WXGA, UXGA, WUXGA Other special formats through specified BIOS and factory adjustment.
Graphics auto mode detect	VGA, SVGA, XGA, SXGA, WXGA, UXGA & WUXGA interlaced and non-interlaced
Standard input at source (analog RGB)	VGA analog (15 pin) standard with automatic detection of: Digital Separate Sync; Composite Sync Sync On Green.
Video formats	PAL, NTSC & SECAM
Video inputs	ARGB DVI-D Component video HDMI
Functions display	On screen display (OSD) of functions
OSD menu functions	Image controls: Panel brightness/contrast, Saturation, Hue, Color temperature, Sharpness, Aspect ratio etc.
OSD menu controls available	Power On/Off Backlight brightness OSD Menu OSD Select up OSD Select down Setting + Setting -
Control interface	Buttons, RS-232, Remote control, Ethernet control
Settings memory	Settings are stored in non volatile memory
PC Connectivity	VGA / SVGA / XGA / SXGA / UXGA / WUXGA analog or digital
Controller dimensions	179mm x 120.4mm (7.1" x 4.74")
Power consumption	10w approx. (not including panel power consumption)
Power load maximum	The controller has an overall 3Amp current limit.
Input voltage	12VDC +/- 25%**
Power protection	Fuse fitted (Resettable)
DC Power handling	Reverse power polarity protection is equipped on the board
Storage temperature limits	-40°C to +85°C
Operating temperature limits	-40°C to +80°C**
Coating	Silicone resin conformal coating. (MOD) DEF-STAN 59/47 Issue 4 & UL QMJU2 compliant.

\*\* Overall suitability for usage in critical applications must be independently tested and verified by the user.

### NOTES

Please note the following:

- For specific panel setup a sample of an LCD may be required (this will be returned) and a copy of the full technical specifications for the panel from the manufacturer.
- Re-layout and custom development services are available.

## APPENDIX I – SIGNAL SUPPORT MODE TABLE

### ARGB (P1) PORT :

Mode	Resolution	Clk [MHz]	Horizontal freq [KHz]	Vertical freq [Hz]	Sync Mode
V_60	640x480 60Hz	25.175	31.469	59.940	Digital Separate Sync
V_60	640x480 60Hz	25.175	31.469	59.940	Composite Sync
V_72	640x480 72Hz	31.500	37.861	72.809	Digital Separate Sync
V_72	640x480 72Hz	31.500	37.861	72.809	Sync On Green
V_72	640x480 72Hz	31.500	37.861	72.809	Composite Sync
V_75	640x480 75Hz	31.500	37.500	75.000	Digital Separate Sync
V_75	640x480 75Hz	31.500	37.500	75.000	Sync On Green
V_75	640x480 75Hz	31.500	37.500	75.000	Composite Sync
SV_56	800x600 56Hz	36.000	35.156	56.250	Digital Separate Sync
SV_56	800x600 56Hz	36.000	35.156	56.250	Composite Sync
SV_60	800x600 60Hz	40.000	37.879	60.317	Digital Separate Sync
SV_60	800x600 60Hz	40.000	37.879	60.317	Sync On Green
SV_60	800x600 60Hz	40.000	37.879	60.317	Composite Sync
SV_72	800x600 72Hz	50.000	48.077	72.188	Digital Separate Sync
SV_72	800x600 72Hz	50.000	48.077	72.188	Sync On Green
SV_72	800x600 72Hz	50.000	48.077	72.188	Composite Sync
SV_75	800x600 75Hz	49.500	46.875	75.000	Digital Separate Sync
SV_75	800x600 75Hz	49.500	46.875	75.000	Sync On Green
SV_75	800x600 75Hz	49.500	46.875	75.000	Composite Sync
X_60	1024x768 60Hz	65.000	48.363	60.004	Digital Separate Sync
X_60	1024x768 60Hz	65.000	48.363	60.004	Sync On Green
X_60	1024x768 60Hz	65.000	48.363	60.004	Composite Sync
X_70	1024x768 70Hz	75.000	56.476	70.069	Digital Separate Sync

X_70	1024x768 70Hz	75.000	56.476	70.069	Sync On Green
X_70	1024x768 70Hz	75.000	56.476	70.069	Composite Sync
X_75	1024x768 75Hz	78.750	60.023	75.029	Digital Separate Sync
X_75	1024x768 75Hz	78.750	60.023	75.029	Sync On Green
X_75	1024x768 75Hz	78.750	60.023	75.029	Composite Sync
SX_60	1280x1024 60Hz	108	63.81	60.020	Digital Separate Sync
SX_60	1280x1024 60Hz	108	63.81	60.020	Sync On Green
SX_60	1280x1024 60Hz	108	63.81	60.020	Composite Sync
SX_75	1280x1024 75Hz	135	79.976	75	Digital Separate Sync
SX_75	1280x1024 75Hz	135	79.976	75	Sync On Green
SX_75	1280x1024 75Hz	135	79.976	75	Composite Sync
WUX_60	1920x1080 60Hz	172.8	67.5	60	Digital Separate Sync
WUX_60	1920x1080 60Hz	172.8	67.5	60	Sync On Green
WUX_60	1920x1080 60Hz	172.8	67.5	60	Composite Sync

Remark :

The controller has been designed to take a very wide range of input signals however to optimize the PC's graphics performance we recommend choosing 60Hz vertical refresh rate. To support on higher refresh rate over 60Hz, the LCD panel may not support.

#### HDMI / DVI input port :

Mode	Resolution	Clk [MHz]	Horizontal freq [KHz]	Vertical freq [Hz]
V_60	640x480 60Hz	25.175	31.469	59.940
V_67	640x480 67Hz	31.5	37.5	67
V_75	640x480 75Hz	31.5	37.5	75
SV_56	800x600 56Hz	36	35.156	56
SV_60	800x600 60Hz	40.000	37.879	60.317
SV_72	800x600 72Hz	50	48.077	72
SV_75	800x600 75Hz	49.5	46.875	75
X_60	1024x768 60Hz	65.000	48.363	60.004
X_70	1024x768 70Hz	75	56.476	70
X_75	1024x768 75Hz	78.75	60.023	75
SX_60	1280x1024 60Hz	108	63.81	60.020
SX_75	1280x1024 75Hz	135	79.976	75
UX_60	1600x1200 60Hz	162	75.000	60
WUX_60	1920x1080 60Hz	172.8	67.5	60
1080p60	1920x1080p 60Hz	135	67.5	60
1080p59	1920x1080 59Hz	148.35	67.433	60
1080p50	1920x1080 50Hz	149	62.75	50
720p60	1280x720P 60Hz	74.25	45	60
576p50	720x576P 50Hz	26.9568	31.2	50
480p60	720x480P 60Hz	26.9568	31.4	60



**Component video port :**

<b>Mode</b>
720p60
720p59.94
720p50
720p30
720p29.97
1080p30
1080p29.97
1080p25
1080p24
1080p23.98
1080i60
1080i59.94
1080i50
1080p60
1080p59.94
1080p50

## Appendix II – RS-232 control protocols

### RS-232 Serial control (Baud rate 2400/4800/9600/14400/19200/38400/57600/115200, 8 bits, 1 stop bit and no parity)

Please refer to Appendix IX for the procedure how to select different baud rate to be used.

#### Physical connection :

Controller side  
Connector interface : CN8  
Mating connector : JST XHP-6

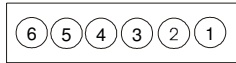

Mating face of CN8

Computer side  
Connector interface : Serial port  
Mating connector : DB9 Female

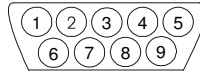

Mating face of RS-232 DB9 Male

PIN#	Description
4	RS-232 Tx Data
5	Ground
6	RS-232 Rx Data

PIN#	Description
2	RS-232 Rx Data
3	RS-232 Tx Data
5	Ground

#### Remark :

(1) : RS-232 connection cable, 600mm P/N 4260902-00 can be ordered separately for connection.

#### Software connection :

The OSD function can be controlled through sending the RS-232 protocol.

The RS-232 program can be custom-made to fit for application or it can be used the serial control program, like Accessport, Telix or Serial Utility program developed by DigitalView. Please contact your local support for information.

## 1. Commands to implement switch mount control buttons

Function	Command	Description	Remark
Menu button	0xf7	Menu button pressed	Button equivalent
Select-down button	0xfa	Select-down button pressed	Button equivalent
Select-up button	0xfb	Select-up button pressed	Button equivalent
Right/+ button	0xfc	Right/+ button pressed	Button equivalent
Left/- button	0xfd	Left/- button pressed	Button equivalent

## 2. Parameter setting - immediate, relative, reset and query

Function	Command	Description	Acknowledge (if enabled)
Brightness control	0x81, nn   "+"   "-"   "r"   "R"   "?" "m" "n" "i", ss, nn "o", ss,	Set brightness = value/increment/decrement Reset Query Current Source Maximum query *1 Minimum query *1 Set, Source, value *1 Query, Source *1	Brightness.  Range : "4""E"- "B""2" Default : "8""0"  ss - reference by Input main select(0x98)
Contrast control - all channels	0x82, "a"   "A", nn   "+"   "-"   "r"   "R"   "?" "m" "n" "i", ss, nn "o", ss,	Set all contrast = value/increment/decrement Reset Query Maximum query *1 Minimum query *1 Set, Source, value *1 Query, Source *1	Contrast  Range : "1""C"- "E""4" Default : "8""0"  ss - reference by Input main select(0x98)
Saturation control	0x83, nn   "+"   "-"   "r"   "R"   "?" "m" "n" "i", ss, nn "o", ss,	Set color = value/increment/decrement Reset Query Maximum query *1 Minimum query *1 Set, Source, value *1 Query, Source *1	PAL/NTSC color (In video mode only)  Range : "0""1"- "F""F" Default : "8""0"  ss - reference by Input main select(0x98)
Hue control	0x84, nn   "+"   "-"   "r"   "R"   "?" "m" "n" "i", ss, nn "o", ss,	Set tint = value/increment/decrement Reset Query Maximum query *1 Minimum query *1 Set, Source, value *1 Query, Source *1	NTSC tint (In NTSC mode only)  Range : "0""1"- "F""F" Default : "8""0"  ss - reference by Input main select(0x98)
Phase (tuning) control	0x85, nn   "+"   "-"   "?"	Set dot clock phase = value/increment/decrement Query	Dot clock phase. (In PC mode only)
Image H position	0x86, nnnn   "+"   "-"   "?"	Set img_hpos = value/increment/decrement Query	Image horizontal position. (In PC mode only)
Image V position	0x87, nnnn   "+"   "-"   "?"	Set img_vpos = value/increment/decrement Query	Image vertical position. (In PC mode only)
Sharpness	0x8a, nn   "+"   "-"   "r"   "R"   "?"	Set sharpness = value/increment/decrement Reset Query	Sharpness. (Video Mode Source only) Default : "0""C"

Specifications subject to change without notice

Frequency	0x8b, nnnn   "+"   "-"   "?"	Set frequency = Value/increment/decrement Query	Graphic mode H active size (in pixels)
Scaling Mode	0x8c, "0"   "1"   "2"   "3"   "9"   "A"   "B"   "C"   "D"   "r"   "R"   "?"	Set graphic image scaling mode = value Reset Query	Image expansion on/off. "0" – 1:1 "1" – fill screen "2" – fill to aspect ratio "9" – 4:3 "A" – 16:9 "B" – 16:10 "C" – 2.35:1 "D" – 2:1
Set display orientation	0x8e, n   "r"   "R"   "?"	Set display orientation = value/increment/decrement Reset Query	"0" – Normal. "1" – Vertical Flip. "2" – Horizontal Flip. "3" – Rotate.
OSD H position	0x90, nnn   "+"   "-"   "r"   "R"   "?"	Set osd_hpos = value/increment/decrement Reset Query	OSD horizontal position.
OSD V position	0x91, nnn   "+"   "-"   "r"   "R"   "?"	Set osd_vpos = value/increment/decrement Reset Query	OSD vertical position.
OSD menu timeout	0x93, nn   "+"   "-"   "r"   "R"   "?"	Select menu timeout = value/increment/decrement Reset Query	OSD menu timeout value. "0""0" – Continuous. value – Round up to nearest available step. if value > max available step, set it to the max available step.
Select OSD language	0x95, n   "r"   "R"   "?"	Select language = English, Chinese,... Reset Query	"0" – English. "2" - French "3" – Spanish "6" - German "8" – Chinese
Input main select	0x98, nn   "+"   "-"   "r"   "R"   "?"	Select input main = PC or VIDEO or next available Reset Query	Main selected.  "0x41,0x31" ARGB "0x42, 0x31" Composite 1** "0x42, 0x32" Composite 2** "0x43, 0x31" S-video 1** "0x43, 0x32" S-video 2** "0x44 0x32" SD Component 1** "0x44 0x33" SD Component 2** "0x44,0x31" Component 1 (via CNV2) "0x46,0x31" DVI "0x48,0x31" HDMI "0x45,0x31" HDSDI** "0x45,0x32" HDSDI2**
Auto Source Seek	0x99, nn , "0"   "1"   "?"   "o"	Set Auto source enable = *1 Source Disable/ Enable Query Valid Source query	"nn" = "0x41,0x31"- ARGB "0x42, 0x31" Composite 1** "0x42, 0x32" Composite 2** "0x43, 0x31" S-video 1** "0x43, 0x32" S-video 2** "0x44 0x32" SD Component 1** "0x44 0x33" SD Component 2** "0x44,0x31"- Component 1 (via CNV2) "0x46,0x31"- DVI "0x48,0x31" HDMI

Specifications subject to change without notice

			"0x45,0x31" HDSDI <sup>++</sup> "0x45,0x32" HDSDI <sup>++</sup>
Source Layout	0x9a, n   "r"   "R"   "?"	Select source layout = Single, PIP, PBP, PBPT Reset, Query	Query: "0"- Single "1"- Picture in Picture (PIP) "2"- Picture by Picture (PBP) "3"- Picture by Picture Tall (PBPT) "F" – Turn ON PIP Window <sup>***</sup>
Auto power off	0x9f, "0"   "1"   "r"   "R"   "?"	Set power down option = On/Off Reset Query	"0" – Off. "1" – On.
Hotkey 1	0xa0, "1", n   "r"   "R"   "?"	Set Hotkey 1= Value Reset Query	"2" – brightness.(Default) "3" – contrast. "4" – colour. "5" – input source. "7" – zoom "8" – freeze "9" - PIP "B" – No function "D" - PIP Swap "E" – Aspect Ratio "G" – Hue "H" – Backlight "I" – Auto Picture Setup "K" - PIP ON/OFF
Hotkey 2	0xa0, "2", n   "r"   "R"   "?"	Set Hotkey 2 = value Reset Query	"2" – brightness.(Default) "3" – contrast. "4" – colour. "5" – input source. "7" – zoom "8" – freeze "9" - PIP "B" – No function "D" - PIP Swap "E" – Aspect Ratio "G" – Hue "H" – Backlight "I" – Auto Picture Setup "K" - PIP ON/OFF
Runtime counter	0xa1, nnnnn   "r"   "R"   "?"	runtime counter value = nnnnn (* 0.5 hour) Reset Query	Runtime = nnnnn.
PIP brightness control	0xa2, nn   "+"   "-"   "r"   "R"   "?"	Set PIP window brightness = value/increment/decrement Reset Query	PIP window brightness.
PIP contrast control	0xa3, nn   "+"   "-"   "r"   "R"   "?"	Set PIP window contrast = value/increment/decrement Reset Query	PIP window contrast.
PIP H position	0xa4, nnn   "+"   "-"   "r"   "R"   "?"	Set PIP_hpos = value/increment/decrement Reset Query	PIP window horizontal position.
PIP V position	0xa5, nnn   "+"   "-"   "r"   "R"   "?"	Set PIP_vpos = value/increment/decrement Reset Query	PIP window vertical position.
PIP window size	0xa6,	Select PIP window size =	Main selected.

Specifications subject to change without notice

select	nn   "r"   "R"   "?"	PIP window size value Reset Query	PIP off if "nn" = "0"0". "0"0 ~ "1"2 "0"0 ~ "1"2 "1"9 : Size by Size "1"A : Size by Size Tall
PIP source select	0xa7, n   "r"   "R"   "?"	Select input main = Video source value Reset Query	Main selected. 0x40 0x30 : PIP OFF "0x41,0x31"- ARGB "0x42, 0x31" Composite 1** "0x42, 0x32" Composite 2** "0x43, 0x31" S-video 1** "0x43, 0x32" S-video 2** "0x44 0x32" SD Component 1** "0x44 0x33" SD Component 2** "0x44,0x31"- Component 1 (via CNV2) "0x46,0x31"- DVI "0x48,0x31" HDMI "0x45,0x31" HDSDI** "0x45,0x32" HDSDI2**
Zoom level	0xa8, nnnn   "+"   "-"   "r"   "R"   "?"	Set Zoom level = value/increment/decrement Reset Query	Zoom level.
Zoom H position	0xa9, nnnn   "+"   "-"   "r"   "R"   "?"	Set Zoom_hpos = value/increment/decrement Reset Query	Zoom window horizontal position.  Default : 0x30 0x30 0x30 0x30 The min and max values will change depends on input resolution.
Zoom V position	0xaa, nnnn   "+"   "-"   "r"   "R"   "?"	Set Zoom_vpos = value/increment/decrement Reset Query	Zoom window vertical position.  Default : 0x30 0x30 0x30 0x30 The min and max values will change depends on input resolution.
Colour temperature select	0xb3, n   "r"   "R"   "?"	Select colour temperature = value Reset Query	Main selected. "0" – 9300K. "1" – 8000K.(Default) "2" – 6500K. "3" – 5000K "4" - User
Red level for selected colour temperature	0xb4,  nn   "+"   "-"   "r"   "R"   "?" "m" "n" "i", ss, c, nn  "o", ss, c	Set the level of the red channel for the selected colour temp. = value/increment/decrement Reset Query Maximum query *1 Minimum query *1 Set, Source, Temperature Group, value *1 Query, Source *1	Red level for selected colour temperature.  Range : "9"C-"F"F Default : "E"3" for 8000K  c – reference by Color Temperature ss - reference by Input main select(0x98)
Green level for selected colour temperature	0xb5,  nn   "+"   "-"   "r"   "R"   "?" "m" "n" "i", ss, c, nn  "o", ss, c	Set the level of the green channel for the selected colour temp. = value/increment/decrement Reset Query Maximum query *1 Minimum query *1 Set, Source, Temperature Group, value *1	Green level for selected colour temperature  Range : "9"C-"F"F Default : "E"3" for 8000K  c – reference by Color Temperature ss - reference by Input main

Specifications subject to change without notice

		Query, Source *1	select(0x98).
Blue level for selected colour temperature	0xb6, nn   "+"   "-"   "r"   "R"   "?" "m" "n" "i", ss, c, nn "o", ss, c	Set the level of the blue channel for the selected colour temp. = value/increment/decrement Reset Query Maximum query *1 Minimum query *1 Set, Source, Temperature Group, value *1 Query, Source *1	Blue level for selected colour temperature.  Range : "9" "C" - "F" "F" Default : "E" "3" for 8000K  c – reference by Color Temperature ss - reference by Input main select(0x98).
Graphic horizontal resolution enquiry	0xb7	Horizontal resolution (in pixels) in 3 digit hex number	"nnn" = horizontal resolution
Graphic vertical resolution enquiry	0xb8	Vertical resolution (in lines) in 3 digit hex number	"nnn" = vertical resolution
Graphic horizontal sync frequency enquiry	0xb9	Horizontal sync frequency (in units of 100Hz) in 3 digit hex number	"nnn" = horizontal frequency
Graphic vertical sync frequency enquiry	0xba	Vertical sync frequency (in units of Hz) in 3 digit hex number and 1 char	"nnnn" = vertical frequency nnn = 3 digit hex c= "i" or "p" interlace or Progressive  0xba added the interlace(i) or Progressive(p) feedback.
OSD status enquiry	0xbb	Status of OSD	"0" – OSD turned off "1" – OSD turned on
Display Video Source Select	0xbc, "?"   "0"   "1"	Display Video source select Query Name of video source not displayed. After switching to a new video source, the name of the video source is displayed for 5 seconds.	"0" – Disabled. "1" – Enabled.
OSD turn off	0xbd	Turn off the OSD.	"0" – fail. "1" – successful.
Query External Memory	0xcb, "2"	Check External Memory 24c256	"0" – Not Installed "1" – Installed "?" – Not Support
Query Revision Number	0xcb, "3"	Read Revision Number	"nn" = Revision number
Backlight control	0xe0, nn   "+"   "-"   "="   "R"   "r"   "?"	Set Backlight = value/increment/decrement Display OSD indicator Reset Query	Backlight. Range: D/A : "0" "0" ~ "5" "2" 100Hz : "0" "0" ~ "8" "3" 120Hz : "0" "0" ~ "6" "D" 140Hz : "0" "0" ~ "5" "D" 160Hz : "0" "0" ~ "5" "2" 180Hz : "0" "0" ~ "4" "8" 200Hz : "0" "0" ~ "4" "2" 220Hz : "0" "0" ~ "3" "B" 240Hz : "0" "0" ~ "3" "6" 260Hz : "0" "0" ~ "3" "2" 280Hz : "0" "0" ~ "2" "E" 300Hz : "0" "0" ~ "2" "B"

			320Hz : "0" "0" ~ "2" "8" 340Hz : "0" "0" ~ "2" "6" 360Hz : "0" "0" ~ "2" "4" 380Hz : "0" "0" ~ "2" "2" 400Hz : "0" "0" ~ "2" "0" 420Hz : "0" "0" ~ "1" "E" 440Hz : "0" "0" ~ "1" "D"
Backlight On/Off	0xe1, "0"   "1"   "R"   "r" "?"	Backlight Off / Backlight On /Status	"0" – Backlight Off "1" – Backlight On.(Default) "?" – Backlight On/Off Query
Backlight D/A / PWM	0xe5 "0"   "1"   "R"   "r" "?"	Set : PWM or D/A  Reset Query	"0" – PWM "1" – D/A (Default)
Backlight PWM Frequency	0xe6, nnn   "+"   "-"   "R"   "r"   "?"	Set Backlight PWM Frequency = value/increment/decrement Reset Query	+/- 20Hz Value 100Hz : "0", "6", "4" 120Hz : "0", "7", "8" 140Hz : "0", "8", "C" 160Hz : "0", "A", "0" (Default) 180Hz : "0", "B", "4" 200Hz : "0", "C", "8" 220Hz : "0", "D", "C" 240Hz : "0", "F", "0" 260Hz : "1", "0", "4" 280Hz : "1", "1", "8" 300Hz : "1", "2", "C" 320Hz : "1", "4", "0" 340Hz : "1", "5", "4" 360Hz : "1", "6", "8" 380Hz : "1", "7", "C" 400Hz : "1", "9", "0" 420Hz : "1", "A", "4" 440Hz : "1", "B", "8"
Backlight Invert	0xe7 "0"   "1"   "R"   "r" "?"	Set On or Off  Reset Query	"0" – Off "1" – On
Red Offset for selected colour temperature	0xe8,  nn   "+"   "-"   "r"   "R"   "?" "m" "n" "i", ss, c, nn  "o", ss, c	Set the Offset of the red channel for the selected colour temp. = value/increment/decrement Reset Query Maximum query *1 Minimum query *1 Set, Source, Temperature Group, value *1 Query, Source *1	Red Offset for selected colour temperature.  Range : "8" "0"-"7" "F" Default : "0" "0"  c – reference by Color Temperature ss - reference by Input main select(0x98)
Green Offset for selected colour temperature	0xe9,  nn   "+"   "-"   "r"   "R"   "?" "m" "n" "i", ss, c, nn  "o", ss, c	Set the Offset of the green channel for the selected colour temp. = value/increment/decrement Reset Query Maximum query *1 Minimum query *1 Set, Source, Temperature Group, value *1 Query, Source *1	Green Offset for selected colour temperature.  Range : "8" "0"-"7" "F" Default : "0" "0"  c – reference by Color Temperature ss - reference by Input main select(0x98)
Blue Offset for selected colour	0xea,  nn   "+"   "-"   "r"   "R"   "?" "m" "n" "i", ss, c, nn  "o", ss, c	Set the Offset of the blue channel for the selected colour	Blue Offset for selected colour temperature.

Specifications subject to change without notice



temperature	nn   "+"   "-"   "r"   "R"   "?" "m" "n" "i", ss, c, nn  "o", ss, c	temp. = value/increment/decrement Reset Query Maximum query *1 Minimum query *1 Set, Source, Temperature Group, value *1 Query, Source *1	Range : "8"0"~"7"0" Default : "0"0"  c – reference by Color Temperature ss - reference by Input main select(0x98)
PIP Window Blend Level	0xed, nn   "+"   "-"   "R"   "r"   "?"	Select PIP Transparency Level PIP Transparency value Reset Query	PIP Transparency "0"0" = 6.25% "0"1" = 12.5% "0"2" = 18.75% "0"3" = 25% "0"4" = 31.25% "0"5" = 37.5% "0"6" = 43.75% "0"7" = 50% "0"8" = 56.25% "0"9" = 62.5% "0"10" = 68.75% "0"11" = 75% "0"12" = 81.25% "0"13" = 87.5% "0"14" = 93.75% "0"15" = 100%.
Light Detector	"0xee", "0x4A" "0"   "1"   "R"   "r" "?" "S"   "s"	Light Detector Off / Light Detector On Light Detector On/Off Query Light Detector Value Query	"0" –Light Detector Off (Default) "1" –Light Detector On. "?" – Light Detector On/Off Query "S" "s" –Light Detector Value Query 0x00~0xFF
Access Programming Mode	"0xee", "0x59" "0"   "1" "?"	Cancel Access / Set Access Query	"0" - Cancel Access "1" - Set next start up to access the programming mode.
Minimum Backlight Value	0xee, "0x5C" nn  "+"   "-"   "R"   "r"   "?"	Set Minimum Backlight value = value / increment / decrement Reset Query	Minimum Backlight value/ Range : D/A : "0"0" ~ "3"2" 100Hz : "0"0" ~ "3"2" 120Hz : "0"0" ~ "3"2" 140Hz : "0"0" ~ "3"2" 160Hz : "0"0" ~ "3"2" 180Hz : "0"0" ~ "3"2" 200Hz : "0"0" ~ "3"2" 220Hz : "0"0" ~ "3"2" 240Hz : "0"0" ~ "3"2" 260Hz : "0"0" ~ "3"2" 280Hz : "0"0" ~ "3"2" 300Hz : "0"0" ~ "3"2" 320Hz : "0"0" ~ "3"2" 340Hz : "0"0" ~ "3"2" 360Hz : "0"0" ~ "3"2" 380Hz : "0"0" ~ "3"2" 400Hz : "0"0" ~ "3"2" 420Hz : "0"0" ~ "3"2" 440Hz : "0"0" ~ "3"1"
OSD Switch Mount Lock	"0xee", "0x62" "0"   "1" "?"	Unlock / Lock Query	"0" - Unlock "1" - Lock
Anti image retention	"0xee", "0x6C" "E", "1"   "0"	Anti image retention On / Off	
Anti image retention Method	"0xee", "0x6C" "M", "0"   "1"   "2"   "3"	Run Anti image retention Method Horizontal Pan Vertical Pan Flash Pixel Shift	
Anti image retention Pixel	"0xee", "0x6C" "P",	Anti image retention Pixel Shift	

Specifications subject to change without notice

Shift Manual	"H"   "V" "nn"   "+"   "-"   "R"   "r"   "?"	Manual Horizontal / Vertical Shift value/increment/decrement Reset Query	
--------------	---	--	--

Remark :

\*\* - Support when AVD-1000 connected.

++ - Support when HD-1000/-2000/-3000S connected.

### 3. Other control

Function	Command	Description	Acknowledge (if enabled)
Select RS-232 acknowledge	0xc1, "0"   "1"	Disable/enable command acknowledge.	"0" – acknowledge disabled. "1" – acknowledge enabled.
Auto-setup	0xc3	Start auto-setup of current vmode.	"0" – fail. "1" – successful.
Command availability	0xc4, n	Check whether a command is available.	"0" – not available. "1" – available.
Auto-calibration	0xc5	Start auto-calibration of gain of the RGB amplifier.	"0" – fail. "1" – successful.
Freeze frame	0xc6, "0"   "1"	Unfreeze / freeze frame	"0" – unfreeze. "1" – freeze.
Soft Power On/Off	0xc8, "0"   "1"   "?"	Soft power off/on query	"0" - Soft power off "1" - Soft power on
Query video input status	0xc9	Query the status of the primary & pip status	"nn,nn" = input status "nn,xx" digit = primary status: "0","0" : invalid "A","1" ARGB "B","1" Composite 1 "B","2" Composite 2 "C","1" S-video 1 "C","2" S-video 2 "D","1" Component 1 (via CNV2) "D","2" SD Component 1 "D","3" SD Component 2 "E","1" HDSDI <sup>++</sup> "E","2" HDSDI 2 <sup>++</sup> "F","1" DVI "H","1" HDMI  "xx,nn" = PIP input status: "0","0": invalid "A","1" ARGB "B","1" Composite 1 "B","2" Composite 2 "C","1" S-video 1 "C","2" S-video 2 "D","1" Component 1 "D","2" SD Component 1 "D","3" SD Component 2 "E","1" HDSDI "E","2" HDSDI 2 "F","1" DVI "H","1" HDMI
Query BIOS version	0xcb, "0"	Read BIOS version	BIOS version "VV.YY.ZZ" VV = V0 or E0, V0 = Release version E0 = Engineering Sample

			YY= Version Number ZZ= Customer Number
Query PCBA number	0xcb, "1"	Read PCBA number	"nnnnn" = PCBA number SVX-1920v3= "41748"
Reset to Factory Defaults	0xce	Reset all parameters to default value	"1" – successful.
Reset to Factory Defaults with (color temp)	0xcf	Reset all parameters for all video modes to default value	"1" - successful.
Saved Calibrated default	0xd7	Saving all parameters to user default value	"1" - successful.
Load Calibrated default	0xd8	Loading all parameters to user default value	"1" - successful. "0" - not successful "E" – Checksum Error
Wide Screen Mode Selection	0xd9, "n""n" "r"   "R" "?"	Wide Screen Mode Reset Query	"n,n" = input status "n,x" digit = Group 1 mode select: "0" – 1024x768 (Default) "1" – 1280x768 "2" – 1366x768 "3" - 1360x768  "x,n" = :Group 2 mode select "4" - 1440x900 (Default) "5" - 1600x900

The following commands for sending texts by using RS-232 command.

Function	Command	Description	Acknowledge (if enabled)
Send Line	0xF0,  "S"  "LL" "TEXT"  "0x0A" Return "1"	"S" = "0x53 or 0x73" Send command ----- - "LL" = "0x30,0x31~0x30,0x34" Line number (Rang 0~4 lines) ----- - "Text"= ASCII code, "0x20~0x7E" Character( Rang 0~34 ) ----- - 0x0A = End of line	"S" – Send Command "LL" – Line Number "Text" – Character "0x0A" – End of Line "1" - successful.
e.g Display "Send Text" message on screen: RS232 Code:"0xF0 0x53 0x30 0x31 0x53 0x65 0x6E 0x64 0x20 0x54 0x65 0x78 0x74 0x0A" Return Code: "0xF0 0x53 0x30 0x31 0x53 0x65 0x6E 0x64 0x20 0x54 0x65 0x78 0x74 0x0A 0x31"			
Clear Line	0xF0,  "C"  "LL"  Return "nn"	"C" = "0x43 or 0x63" Clear command ----- - "LL" = "0x30,0x31~0x30,0x34" Line number (Rang 0~4 lines)	"C" – Clear command "LL" – Line Number "nn" – Return Line number
e.g Clear Line 1 RS232 Code: "0xF0 0x43 0x30 0x31" Return Code: "0xF0 0x43 0x30 0x31 0x30 0x31"			

Specifications subject to change without notice

Text Window Horizontal Position	0xF0,  "H" "ss"  Return "nn"	"H" = "0x48 or 0x68" ----- --"nn" = "0x30,0x30~0x46,0x46"	"H" – Horizontal Position command "ss" – Set Horizontal Position number "nn" – Return Position number
e.g Set Text Window Horizontal Position RS232 Code: "0xF0 0x48 0x30 0x31" Return Code: "0xF0 0x48 0x30 0x31 0x30 0x31"			
Text Window Vertical Position	0xF0,  "V" "ss"  Return "nn"	"V" = "0x56 or 0x76" ----- --"nn" = "0x30,0x30~0x46,0x46"	"V" – Vertical Position command "ss" – Set Vertical Position number "nn" – Return Position number
e.g Set Text Window Vertical Position RS232 Code: "0xF0 0x56 0x30 0x31" Return Code: "0xF0 0x56 0x30 0x31 0x30 0x31"			

Left offset	0xF0,  "O" "SSS"  Return "nnn"	"O" = "0x4F or 0x6F" Set Left Offset command ----- - "SSS" = "0x30,0x30,0x30~ 0x33,0x46,0x46" Offset Value (Rang 000~3ff)	"O" – Left Offset Command "SSS"- Offset Value (pixels) "nnn"- Return Value(pixels)
e.g Set Left Offset = 100 pixels ( 0x64 (HEX)) RS232 Code: "0xF0 0x4F 0x30 0x36 0x34" Return Code: "0xF0 0x4F 0x30 0x36 0x34 0x30 0x36 0x34"			

Text Window Horizontal Size	0xF0,  "X" "SSS"  Return "nnn"	"X" = "0x58" Set Horizontal Size command ----- - "SSS" = "0x31,0x45,0x30~ 0x37,0x38,0x30" Horizontal Size Value (Rang 000~3ff)	"X" –Horizontal Size "SSS"- Size Value (pixels) "nnn"- Return Value(pixels)
e.g Set Text Window Horizontal Size = 640 pixels ( 0x280 (HEX)) RS232 Code: "0xF0 0x58 0x32 0x38 0x30" Return Code: "0xF0 0x58 0x32 0x38 0x30 0x32 0x38 0x30"			

Background Transparency	0xF0,  "B" "N"  Return "n"	"B" = "0x42 or 0x62" Set Transparency command ----- "N" = "0x30~0x46" Transparency Value (Rang 00~0F)	"B" - Transparency command "N" – Transparency Value "n"- Return Value  0x00 =opaque
Set background Transparency value is 8 RS232 Code: "0xF0 0x42 0x38" Return Code: "0xF0 0x42 0x38 0x38"			

Text Overlay Background On or Off	0xF0,  "Q"  "N" Return "n"	"Q" = "0x51 or 0x71" Set Background Enable or Disable ----- "N" = "0x30~0x31"	"B" - command "1" Turn On Text Overlay Background "0" Turn Off Text Overlay Background "n"- Return Value
-----------------------------------	-------------------------------------	---	---

Set background Transparency value is 8 RS232 Code: "0xF0 0x51 0x31" Return Code: "0xF0 0x51 0x31 0x31"			

Please set the "Background Transparency" and "Left offset" commands before the "Send Line" command.

**The RS-232 command strings sent in one time can support up to 380 bytes via CN8 port  
The RS-232 command string sent in one time can support up to 50 bytes via CN1 or J1 port.**

**n = 1-byte ascii-coded hex number, e.g., parameter value of 0x1 is represented by "1" (0x31).  
mn or nn = 2-byte ascii-coded hex number, e.g., parameter value of 0x1e is represented by "1", "e" | "E"  
(0x31, 0x6e|0x4e).**

**Please refer to the ASCII to Hex convert table below.**

### Hex to ASCII conversion table

Hex	ASCII	Hex	ASCII	Hex	ASCII	Hex	ASCII
0x30	0	0x41	A	0x61	a	0x2B	+
0x31	1	0x42	B	0x62	b	0x2D	-
0x32	2	0x43	C	0x63	c	0x3F	?
0x33	3	0x44	D	0x64	d		
0x34	4	0x45	E	0x65	e		
0x35	5	0x46	F	0x66	f		
0x36	6	0x47	G	0x67	g		
0x37	7	0x48	H	0x68	h		
0x38	8	0x49	I	0x69	i		
0x39	9	0x4A	J	0x6A	j		
		0x4B	K	0x6B	k		
		0x4C	L	0x6C	l		
		0x4D	M	0x6D	m		
		0x4E	N	0x6E	n		
		0x4F	O	0x6F	o		
		0x50	P	0x70	p		
		0x51	Q	0x71	q		
		0x52	R	0x72	r		
		0x53	S	0x73	s		
		0x54	T	0x74	t		
		0x55	U	0x75	u		
		0x56	V	0x76	v		
		0x57	W	0x77	w		
		0x58	X	0x78	x		
		0x59	Y	0x79	y		
		0x5A	Z	0x7A	z		

## Appendix III – Mapping definition

- Definition of Mapping A :

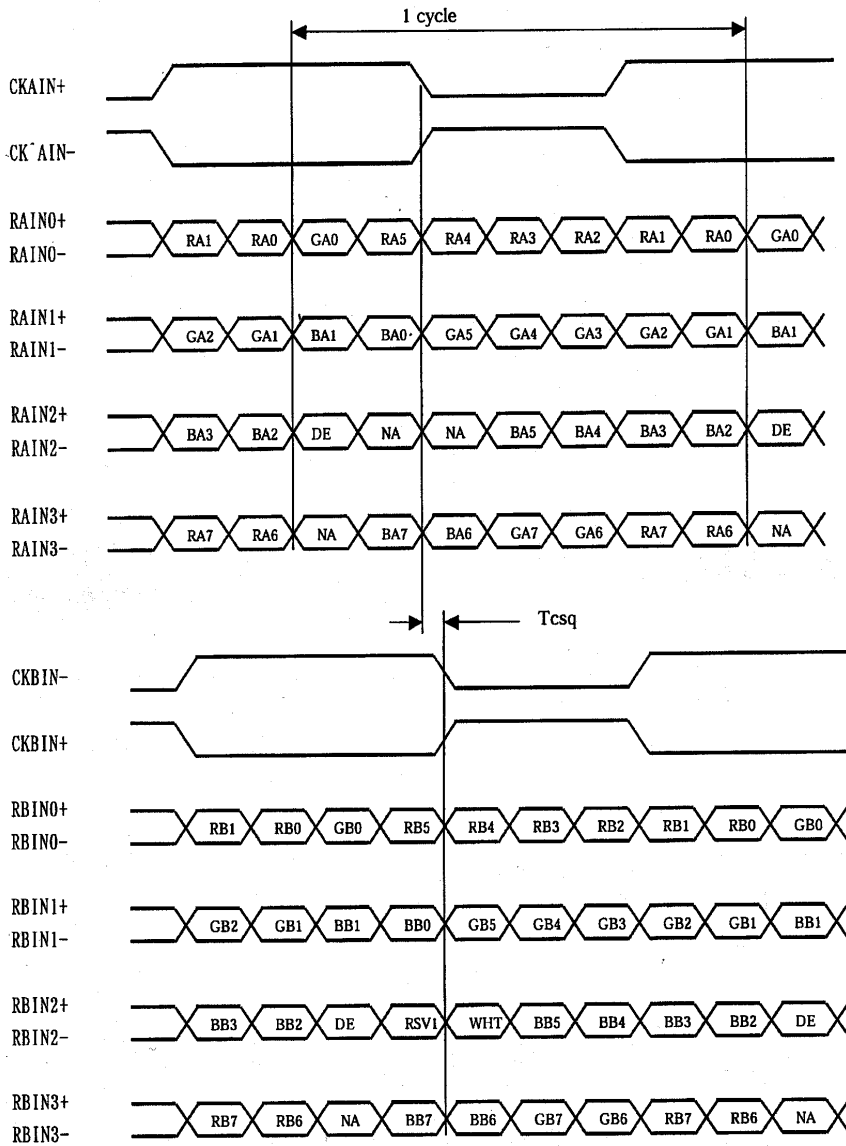

- Definition of Mapping B :

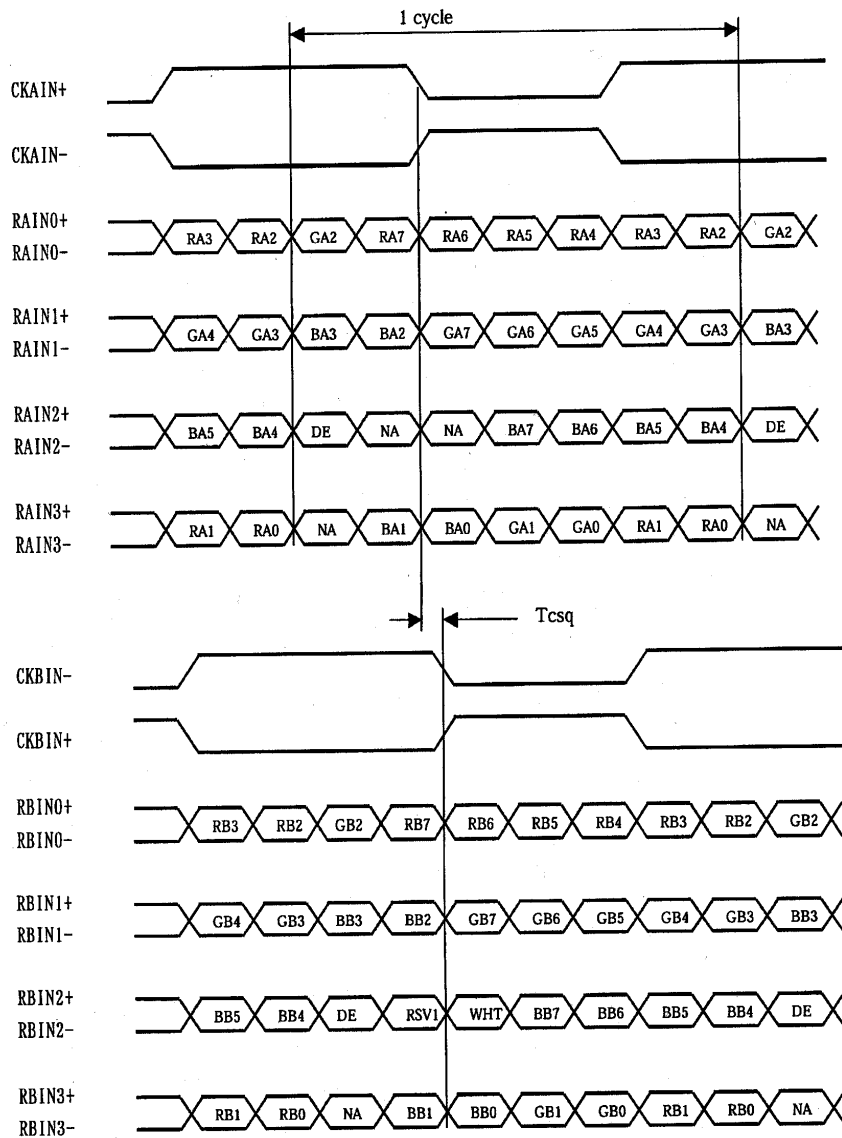



- Definition of VESA :

DPort Output Pair	Bit 6	Bit 5	Bit 4	Bit 3	Bit 2	Bit 1	Bit 0
DB[7:6] / TXDEC							
DB[3:2] / TXDE0	GE0	RE5	RE4	RE3	RE2	RE1	RE0
DB[5:4] / TXDE1	BE1	BE0	GE5	GE4	GE3	GE2	GE1
DB[9:8] / TXDE2	EN	VS	HS	BE5	BE4	BE3	BE2
DG[3:2] / TXDE3	field/prg	BE7	BE6	GE7	GE6	RE7	RE6
DG[5:4] / TXDE4	low	BE9	BE8	GE9	GE8	RE9	RE8
DG[7:6] / TXDO0	GO0	RO5	RO4	RO3	RO2	RO1	RO0
DG[9:8] / TXDO1	BO1	BO0	GO5	GO4	GO3	GO2	GO1
DR[5:4] / TXDO2	EN	VS	HS	BO5	BO4	BO3	BO2
DR[7:6] / TXDO3	field/prg	BO7	BO6	GO7	GO6	RO7	RO6
DR[9:8] / TXDO4	low	BO9	BO8	GO9	GO8	RO9	RO8
DR[3:2] / TXDOC							

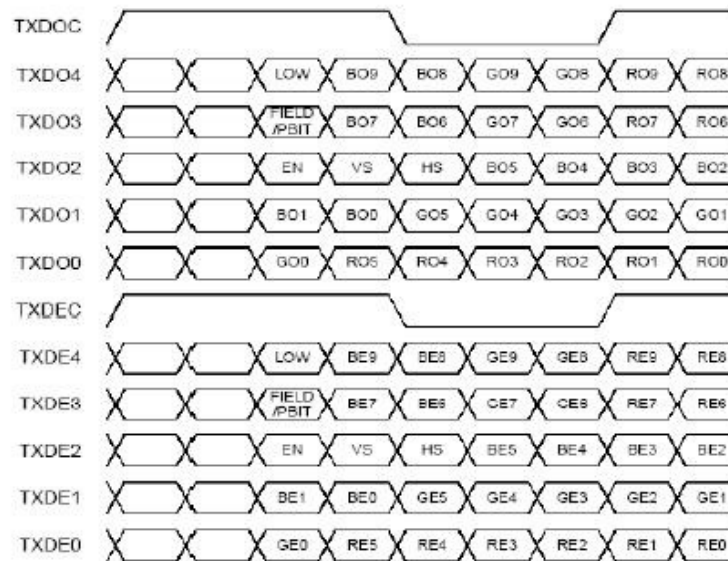

- Definition of JEIDA :

DPort Output Pair	Bit 6	Bit 5	Bit 4	Bit 3	Bit 2	Bit 1	Bit 0
DB[7:6] / TXDEC							
DB[3:2] / TXDE0	GE4	RE9	RE8	RE7	RE6	RE5	RE4
DB[5:4] / TXDE1	BE5	BE4	GE9	GE8	GE7	GE6	GE5
DB[9:8] / TXDE2	EN	VS	HS	BE9	BE8	BE7	BE6
DG[3:2] / TXDE3	field/prg	BE3	BE2	GE3	GE2	RE3	RE2
DG[5:4] / TXDE4	low	BE1	BE0	GE1	GE0	RE1	RE0
DG[7:6] / TXDO0	GO4	RO9	RO8	RO7	RO6	RO5	RO4
DG[9:8] / TXDO1	BO5	BO4	GO9	GO8	GO7	GO6	GO5
DR[5:4] / TXDO2	EN	VS	HS	BO9	BO8	BO7	BO6
DR[7:6] / TXDO3	field/prg	BO3	BO2	GO3	GO2	RO3	RO2
DR[9:8] / TXDO4	low	BO1	BO0	GO1	GO0	RO1	RO0
DR[3:2] / TXDOC							

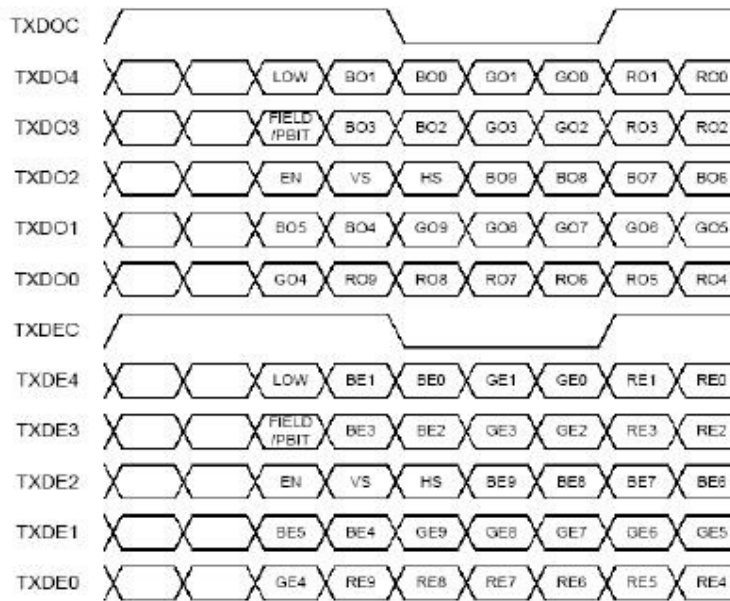

## Appendix IV – Auto Color Gain

The Auto Color Gain function is supported in the ARGB mode only and is designed to calibrate the controller to the incoming video signal. In order to calibrate correctly, the display must be displaying an image containing both black and white data (see illustration below) when the function is used. The internal processor of the video controller chip will then execute a process to adjust the relative values of the RGB signals to achieve the best performance. The parameters of the corrected RGB values are then stored in the controller and are unaffected by the Reset Factory Defaults function.

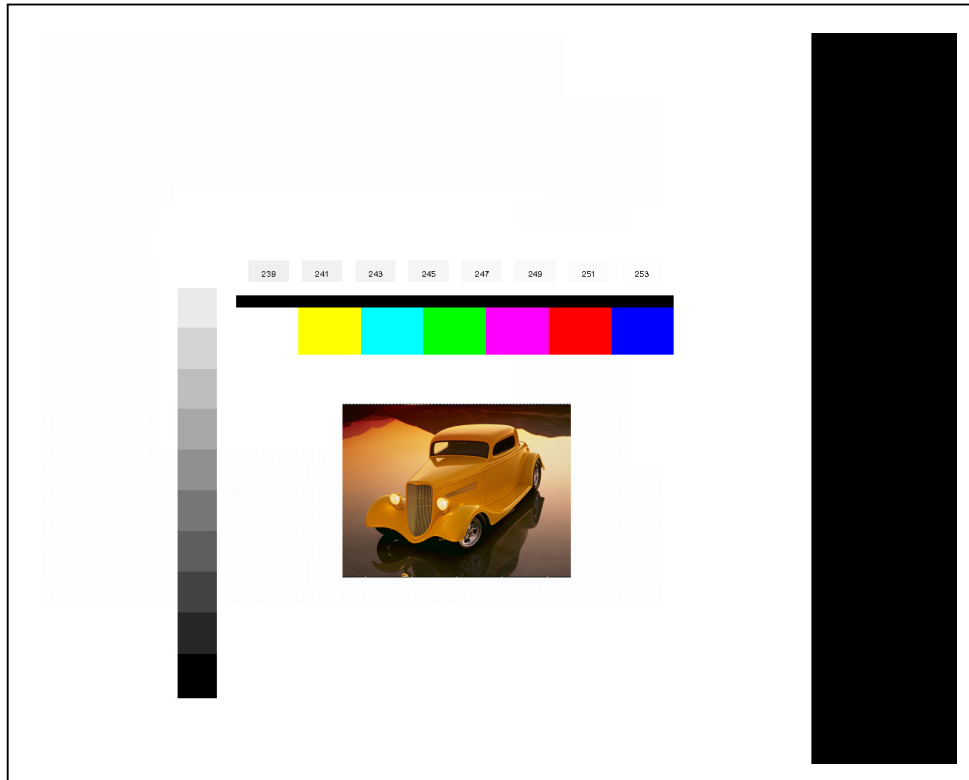

The reference pattern can be downloaded at :  
[http://www.digitalview.com/support/downloads/TestPattern\\_1280.BMP](http://www.digitalview.com/support/downloads/TestPattern_1280.BMP)

This reference pattern is for 1280x1024 resolution and it needs to set your ARGB input source to 1280x1024 resolution before performing the Auto Color Gain function. The position of the black vertical bar in the pattern at the right side is important. It will affect the calibration result if you are setting the ARGB input to other resolution.

**Warning** - If the Auto Color Gain is executed without an appropriate image being displayed, then the process will set incorrect values and the display colors will be distorted. If this occurs, then it can either be corrected by performing the process correctly or if this is not possible then the Reset Color Gain function can be used. This function will reset the stored RGB values to a set of approximate values.

## Appendix V – DV remote control unit work for HX-1920v3

**P/N 559000106-3 :**  
DigitalView remote control unit  
(without DV logo silk screen  
printing)

**P/N 559000105-3 :**  
DigitalView remote control unit  
(with DigitalView logo silk screen  
printing)



BUTTON	FUNCTION
POWER BUTTON	Soft power ON/OFF button.
SEL UP ( ^ ) / SEL DN ( v )	Use this button to direct control the hotkey function. Press the "SEL UP" button to increase the pre-set hotkey parameter value and the "SEL DN" button to decrease the pre-set hotkey parameter value. In OSD menu, pressing this button to select the items.
+ / - BUTTON	Use this button to direct control the hotkey function. Press the "+" button to increase the pre-set hotkey parameter value and the "-" button to decrease the pre-set hotkey parameter value. In OSD menu, pressing this button to adjust the settings.
OSD BACK BUTTON	Use to display the OSD menu and go to the previous OSD screen.
OSD NEXT BUTTON	Use to display the OSD menu and go to the next OSD screen.
DISPLAY BUTTON	Use to view an on-screen information. When OSD menu displayed, press this button to turn it off.
AV/TV BUTTON	Use to select the input source. (VGA/DVI/HDMI/..)
SOUND (ZOOM) BUTTON	Use to display the zoom menu. Press the "+" to zoom in the picture and the "-" to zoom out the picture.
PLAY (YPbPr) BUTTON	Press this button in the non OSD menu display mode to select Component 1 source.
STOP (VGA) BUTTON	Press this button in the non OSD menu display mode to select VGA source.
DVI BUTTON	Press this button in the non OSD menu display mode to select DVI source.
HDMI BUTTON	Press this button in the non OSD menu display mode to select HDMI source.

## Appendix VI – PIP mix table

PIP \ MAIN	VGA (P1)	DVI (P2/CN2)	HDMI (P3/CN5)	Component (CNV2)
VGA (P1)	X	✓	✓	X
DVI (P2/CN2)	✓	X	X	✓
HDMI (P3/CN5)	✓	X	X	✓
Component (CNV2)	X	✓	✓	X

Connect HD/SDI (via HD-1000/2000/3000S) input from HDMI port (P3 / CN5)

PIP \ MAIN	VGA (P1)	DVI (P2/CN2)	HDMI (P3/CN5)	Component (CNV2)	HD-SDI 1 (via HD-1000/2000/3000S)	HD-SDI 2 (via HD-2000)
VGA (P1)	X	✓	/	X	✓	✓
DVI (P2/CN2)	✓	X	/	✓	X	X
HDMI (P3/CN5)	/	/	/	/	/	/
Component (CNV2)	X	✓	/	X	✓	✓
HD-SDI 1	✓	X	/	✓	X	X
HD-SDI 2	✓	X	/	✓	X	X

Connect HD/SDI (via HD-1000/2000/3000S) input from DVI port (P2 / CN2)

PIP / MAIN	VGA (P1)	DVI (P2/CN2)	HDMI (P3/CN5)	Component (CNV2)	HD-SDI 1 (via HD-1000/2000/3000S)	HD-SDI 2 (via HD-2000)
VGA (P1)	X	/	✓	X	✓	✓
DVI (P2/CN2)	/	/	/	/	/	/
HDMI (P3/CN5)	✓	/	X	✓	X	X
Component (CNV2)	X	/	✓	X	✓	✓
HD-SDI 1 (via HD-1000/2000/3000S)	✓	/	X	✓	X	X
HD-SDI 2 (via HD-2000)	✓	/	X	✓	X	X

***PIP mix table for HX-1920v3 (using V1.16.00.00 firmware) with AVD-1000 (using E1.02.00 or up firmware)***

PIP \ MAIN		VGA (P1)	DVI (P2/CN2)	HDMI (P3/CN5)	Component (CNV2)	From AVD-1000 (via CN6 on HX-1920v3)					
						Composite 1	Composite 2	S-Video 1	S-Video 2	SD component 1	SD component 2
VGA (P1)		X	✓	✓	X	✓	✓	✓	✓	✓	✓
DVI (P2/CN2)		✓	X	X	✓	X	X	X	X	X	X
HDMI (P3/CN5)		✓	X	X	✓	X	X	X	X	X	X
Component (CNV2)		X	✓	✓	X	✓	✓	✓	✓	✓	✓
From AVD-1000 (via CN6 on HX-1920v3)	Composite 1	✓	X	X	✓	X	X	X	X	X	X
	Composite 2	✓	X	X	✓	X	X	X	X	X	X
	S-Video 1	✓	X	X	✓	X	X	X	X	X	X
	S-Video 2	✓	X	X	✓	X	X	X	X	X	X
	SD Component 1	✓	X	X	✓	X	X	X	X	X	X
	SD Component 2	✓	X	X	✓	X	X	X	X	X	X

***PIP mix table for HX-1920v3 (using V1.16.00.00 firmware) with AVD-1000 (using E1.02.00 or up firmware) and HD-1000/2000/3000S***

Connect HD/SDI (via HD-1000/2000/3000S) input from HDMI port (P3 / CN5)

PIP \ MAIN	VGA (P1)	DVI (P2/CN2)	HDMI (P3/CN5)	Component (CNV2)	From HD-1000/2000/3000S (via P3/CN5 on HX-1920v3)		From AVD-1000 (via CN6 on HX-1920v3)					
					HD-SDI 1	HD-SDI 2	Composite 1	Composite 2	S-Video 1	S-Video 2	SD component 1	SD component 2
VGA (P1)	X	✓	/	X	✓	✓	✓	✓	✓	✓	✓	✓
DVI (P2/CN2)	✓	X	/	✓	X	X	X	X	X	X	X	X
HDMI (P3/CN5)	/	/	/	/	/	/	/	/	/	/	/	/
Component (CNV2)	X	✓	/	X	✓	✓	✓	✓	✓	✓	✓	✓
HD-SDI 1	✓	X	/	✓	X	X	X	X	X	X	X	X
HD-SDI 2	✓	X	/	✓	X	X	X	X	X	X	X	X
From AVD-1000 (via CN6 on HX-1920v3)	Composite 1	✓	X	/	✓	X	X	X	X	X	X	X
	Composite 2	✓	X	/	✓	X	X	X	X	X	X	X
	S-Video 1	✓	X	/	✓	X	X	X	X	X	X	X
	S-Video 2	✓	X	/	✓	X	X	X	X	X	X	X
	SD Component 1	✓	X	/	✓	X	X	X	X	X	X	X
	SD Component 2	✓	X	/	✓	X	X	X	X	X	X	X

Connect HD/SDI (via HD-1000/2000/3000S) input from DVI port (P2 / CN2)

PIP / MAIN	VGA (P1)	DVI (P2/CN2)	HDMI (P3/CN5)	Component (CNV2)	From HD-1000/2000/3000S (via P3/CN5 on HX-1920v3)		From AVD-1000 (via CN6 on HX-1920v3)					
					HD-SDI 1	HD-SDI 2	Composite 1	Composite 2	S-Video 1	S-Video 2	SD component 1	SD component 2
VGA (P1)	X	/	✓	X	✓	✓	✓	✓	✓	✓	✓	✓
DVI (P2/CN2)	/	/	/	/	/	/	/	/	/	/	/	/
HDMI (P3/CN5)	✓	/	X	✓	X	X	X	X	X	X	X	X
Component (CNV2)	X	/	✓	X	✓	✓	✓	✓	✓	✓	✓	✓
HD-SDI 1 (via HD-1000/2000/3000S)	✓	/	X	✓	X	X	X	X	X	X	X	X
HD-SDI 2 (via HD-2000)	✓	/	X	✓	X	X	X	X	X	X	X	X
From AVD-1000 (via CN6 on HX-1920v3)	Composite 1	✓	/	✓	X	X	X	X	X	X	X	X
	Composite 2	✓	/	✓	X	X	X	X	X	X	X	X
	S-Video 1	✓	/	✓	X	X	X	X	X	X	X	X
	S-Video 2	✓	/	✓	X	X	X	X	X	X	X	X
	SD Component 1	✓	/	✓	X	X	X	X	X	X	X	X
	SD Component 2	✓	/	✓	X	X	X	X	X	X	X	X

Remark : Supporting PIP on dual digital (HDMI on DVI / DVI on HDMI) input is possible with custom firmware. Please contact DigitalView in details.

---

## Appendix VII – Network connection

The HX-1920v3 LCD interface controller has an RJ-45 Ethernet port for control and monitoring over a network. This application note introduces the two user interface modes:

- Command line direct mode (this is the default mode)
- Browser based web server mode

There is also a short overview of the command set and how it is implemented.

### QUICK GUIDE

For experienced users the following quick guide to trying out the network connection and functions may be useful.

**Command line direct mode:** The HX-1920v3 ships with the command line direct mode installed as default. This is relevant when a PC application is used to send and receive commands over the network port.

**Browser based web server mode :** The network port will require an alternative firmware version if the browser based web server mode is required.

- Works with a normal network with DHCP, i.e. must use a router.
- Connect the HX-1920v3 to the network and ensure power is on.
- Use the IP Locator utility available from the IP-50 web-page.  
<http://www.digitalview.com/media/downloads/IPLocator.zip> (Windows only)
- Double click on the IP address in the IP Locator window, it will open the HX-1920v3 browser page in your default browser. Alternatively copy the IP address into your browser address line.
- Test the functions that come up on the browser.

For details, please refer to the separate application note.



## Appendix VIII – HD-1000 / HD-2000 / HD-3000S & AVD-1000 connection

### HX-1920v3 & HD-1000 / HD-2000 connection :

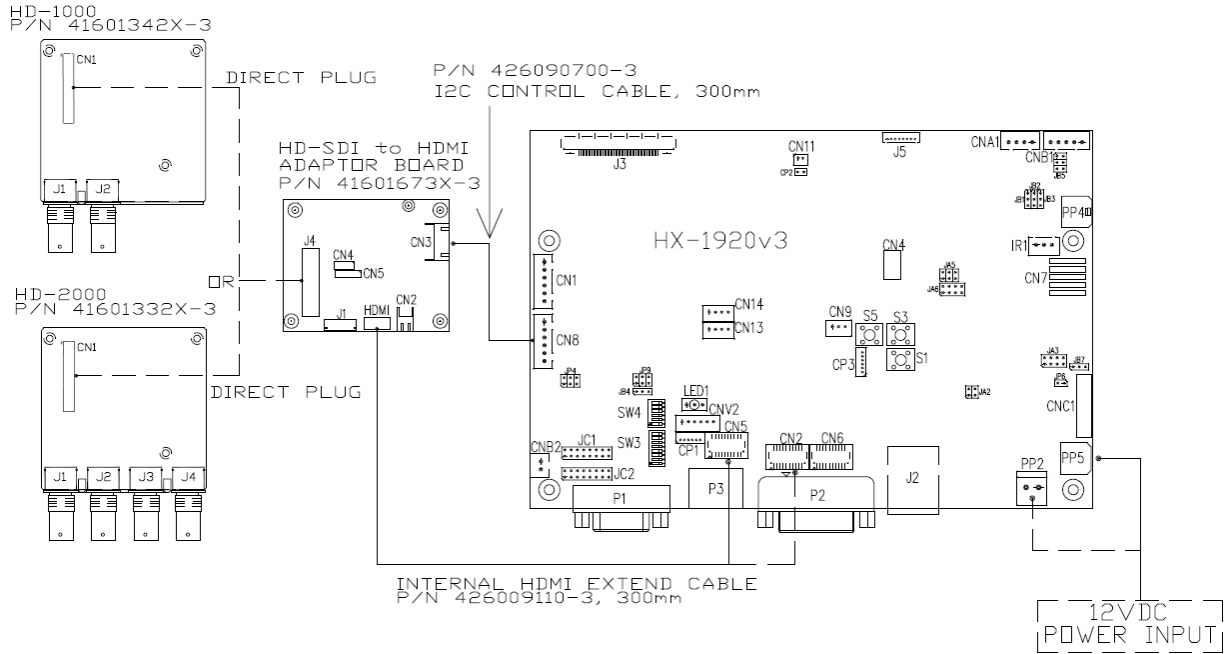

### HX-1920v3 & HD-3000S connection :

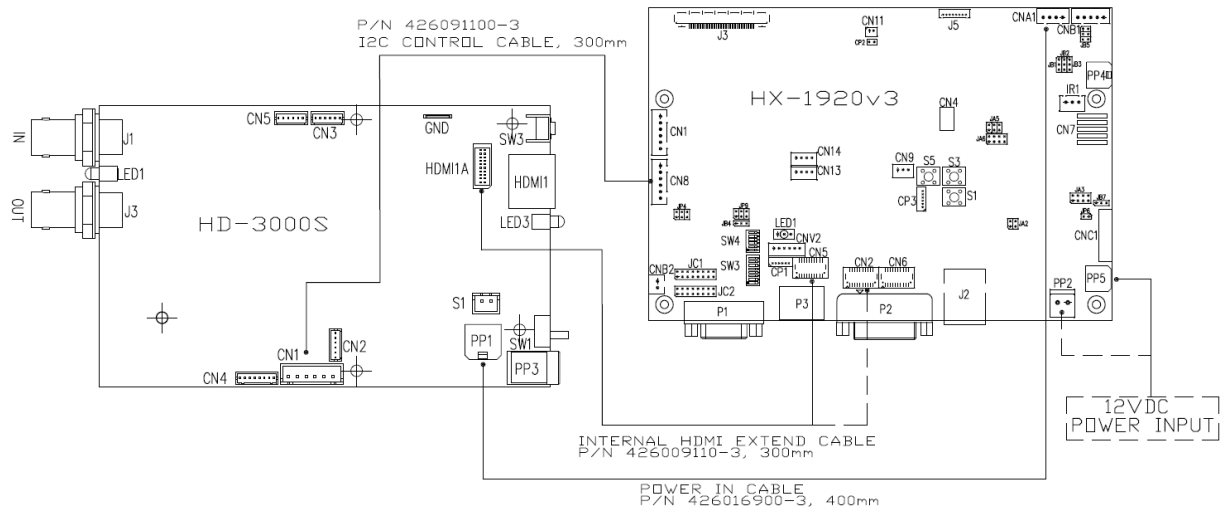

Please note that the overall suitability and image quality acceptance for usage in critical applications must be independently tested and verified by the user.

**HX-1920v3 & HD-1000 / HD-2000 & AVD-1000 connection :**

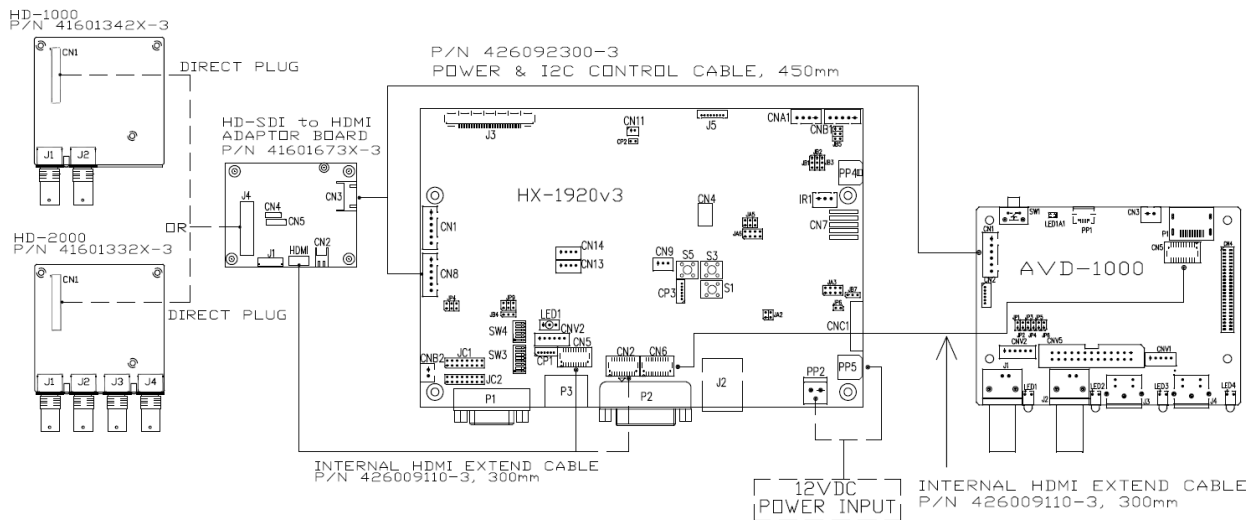

**HX-1920v3 & HD-3000S & AVD-1000 connection :**

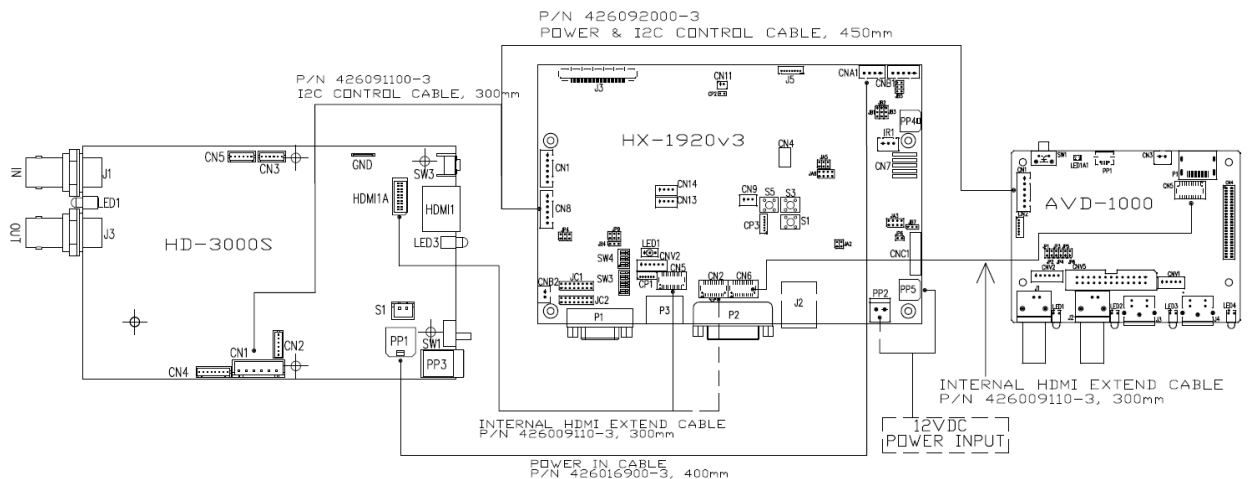

Please note that the overall suitability and image quality acceptance for usage in critical applications must be independently tested and verified by the user.

The controller allow to select two different input port for HD-1000/2000/3000S connections :

Press and hold “MENU” button on the OSD switch mount and turn on the controller to enter the “Programming mode”. Choose “HDSDI Port Select” shown below :

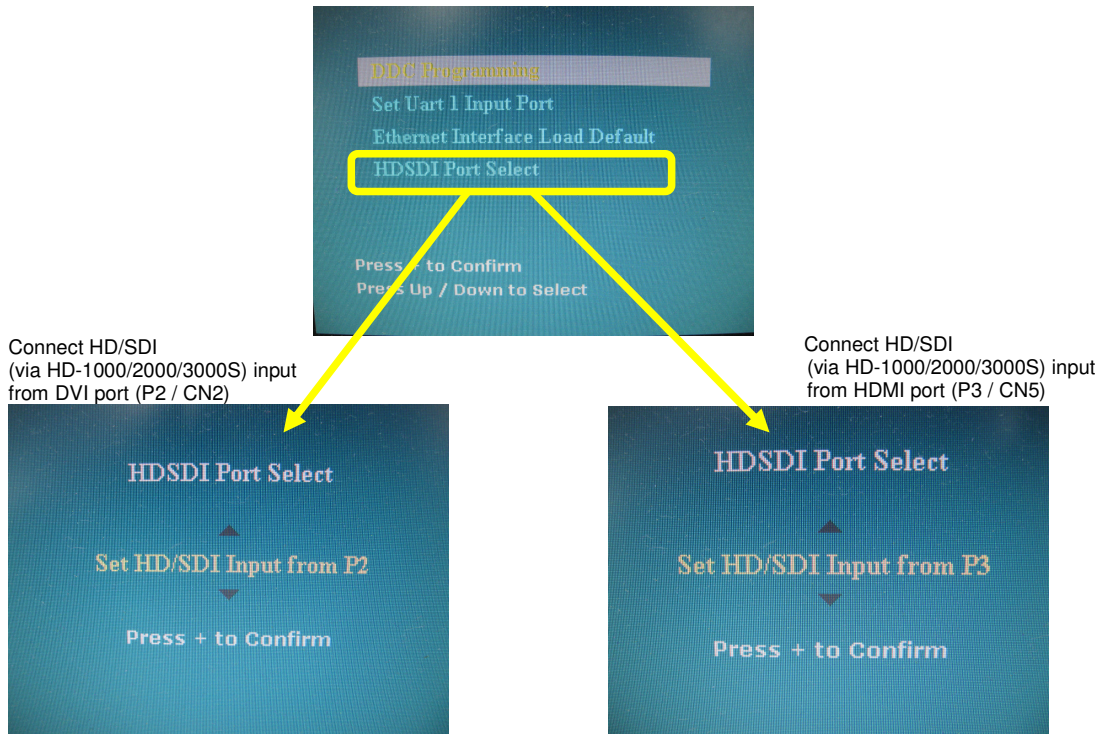

## Appendix IX – Procedure for showing how to select the baud rate

Jumper function :

JC1-3 = Closed : Enable the baud rate selection function

JC1-3 = Open : Disable the baud rate selection function and default set as 2400.

### STEP 1 :

Set JC1-3 = closed.

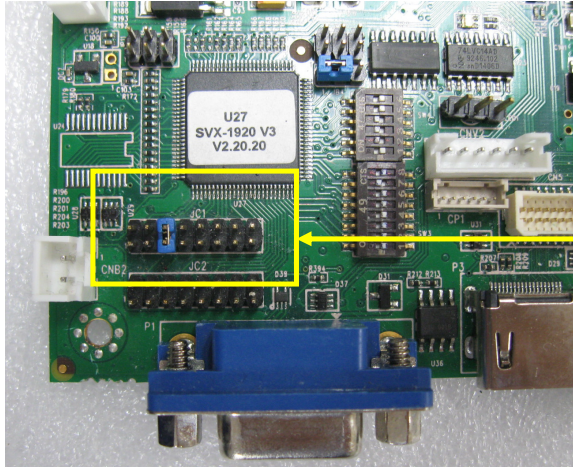

JC1-3 closed to enable the baud rate selection function

### STEP 2 :

Press and hold “MENU” button on the OSD switch mount and turn on the controller to enter the “Programming mode”.

“Programming mode” wordings will display on screen on the target programming board. (See below) :

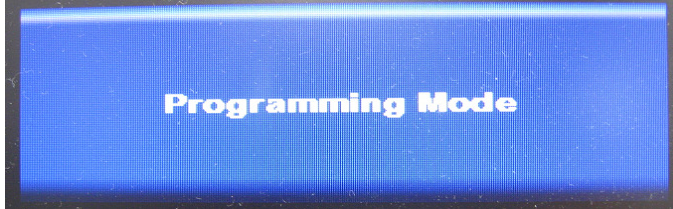

**Step 3 :** Press “MENU” key to go into the “DDC Programming” & “Set RS232 Baud Rate” page. (See below) :

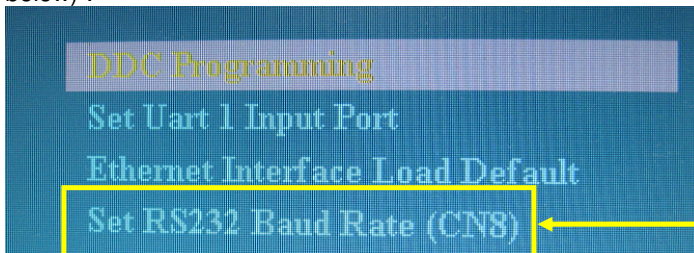

**Step 4 :** Select “Set RS232 Baud Rate” setting, then press “+” to enter the sub menu page.

**Step 5 :** Choose the appropriate baud rate settings (2400 / 4800 / 9600 / 14400 / 19200 / 38400 / 57600 / 115200).

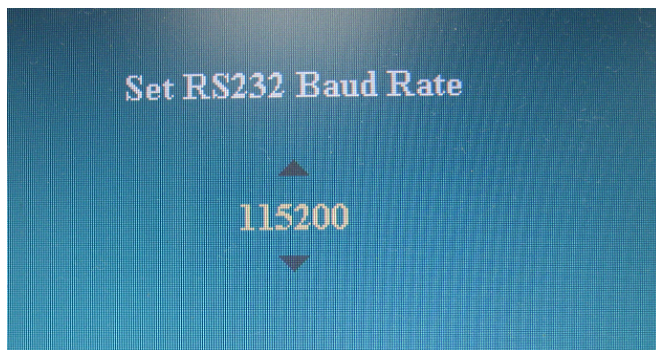
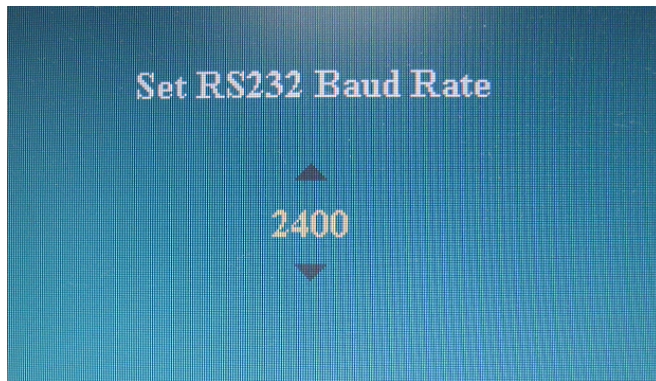

**Step 5 :** Press "MENU" key to return previous menu.

**Step 6 :** Shut off the controller

---

## **WARRANTY**

The products are warranted against defects in workmanship and material for a period of three (3) year from the date of purchase provided no modifications are made to it and it is operated under normal conditions and in compliance with the instruction manual.

The warranty does not apply to:

- Product that has been installed incorrectly, this specifically includes but is not limited to cases where electrical short circuit is caused.
- Product that has been altered or repaired except by the manufacturer (or with the manufacturer's consent).
- Product that has subjected to misuse, accidents, abuse, negligence or unusual stress whether physical or electrical.
- Ordinary wear and tear.

Except for the above express warranties, the manufacturer disclaims all warranties on products furnished hereunder, including all implied warranties of merchantability and fitness for a particular application or purpose. The stated express warranties are in lieu of all obligations or liabilities on the part of the manufacturer for damages, including but not limited to special, indirect consequential damages arising out of or in connection with the use of or performance of the products.

---

## **CAUTION**

Whilst care has been taken to provide as much detail as possible for use of this product it cannot be relied upon as an exhaustive source of information. This product is for use by suitably qualified persons who understand the nature of the work they are doing and are able to take suitable precautions and design and produce a product that is safe and meets regulatory requirements.

---

## **LIMITATION OF LIABILITY**

The manufacturer's liability for damages to customer or others resulting from the use of any product supplied hereunder shall in no event exceed the purchase price of said product.

---

## **TRADEMARKS**

The following are trademarks of Digital View Ltd:

- Digital View
- HX-1920v3

---

## CONTACT DETAILS

Digital View has offices in Asia, Europe and USA :

### USA

Digital View Inc.  
18440 Technology Drive  
Building 130  
Morgan Hill,  
California, 95037  
USA

**Tel:** (1) 408-782 7773      **Fax:** (1) 408-782 7883

**Sales:** [ussales@digitalview.com](mailto:ussales@digitalview.com)

### EUROPE

Digital View Ltd.  
The Lake House  
Knebworth Park  
Herts, SG3 6PY  
UK

**Tel:** +44-(0)20-7631-2150      **Fax:** +44-(0)20-7631-2156

**Sales:** [uksales@digitalview.com](mailto:uksales@digitalview.com)

### ASIA

Digital View Ltd  
Units 705-708, 7/F Texwood Plaza  
6 How Ming Street  
Kwun Tong  
Hong Kong

**Tel:** (852) 2861 3615      **Fax:** (852) 2520 2987

**Sales:** [hksales@digitalview.com](mailto:hksales@digitalview.com)

### WEBSITE

[www.digitalview.com](http://www.digitalview.com)

## Revision History

Date	Rev No.	Page	Summary
7 Nov 2014	1.00	All	First issued
5 Mar 2015	2.00	All	Reflect the features added on firmware V1.12.00.00 revision
26 Oct 2015	3.00	All	Reflect the features added on firmware V1.16.00.00 revision
25 Nov 2019	3.01	24	- Revised pin 16 on DVI-D (P2) connector to 'Hot plug pin'