

LOC	DIST	REVISIONS					
		P	LTR	DESCRIPTION		DATE	APVD
—	—		B	ECR-17-000462		12JAN2017	RG

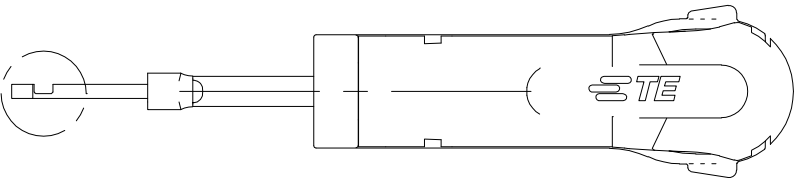

A

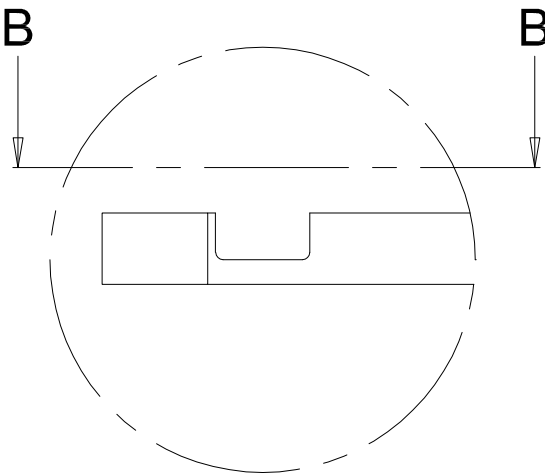
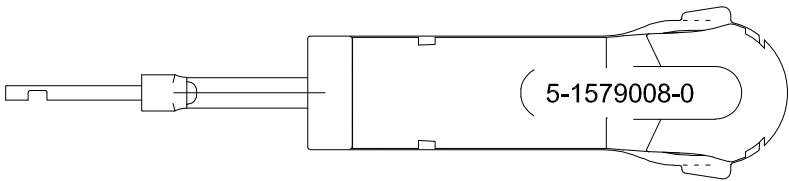
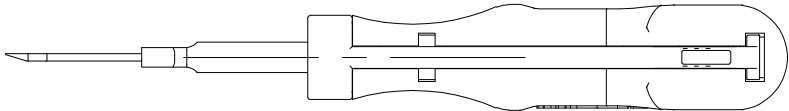

A
5:1



B-B
5:1

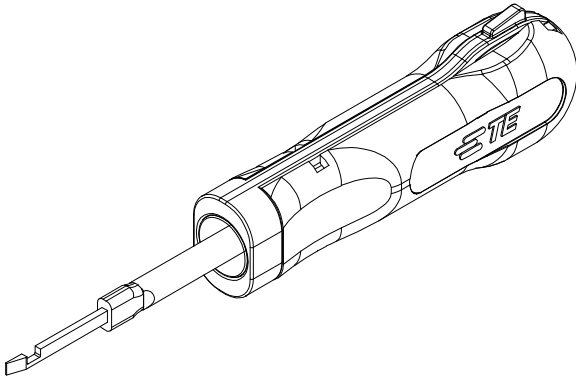

FOR CONTACTS / HOUSINGS:
RH secondary lock

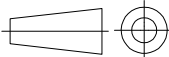
THIS DRAWING IS A CONTROLLED DOCUMENT.		DWN m. pearson	06.11.2006		 TE Connectivity					
		CHK —	06.11.2006							
DIMENSIONS: mm		TOLERANCES UNLESS OTHERWISE SPECIFIED:		APVD —	NAME					
		0 PLC ± —		PRODUCT SPEC —	EXTRACTION TOOL Entriegelungswerkzeug					
		1 PLC ± —								
		2 PLC ± —		APPLICATION SPEC —	SIZE A3	CAGE CODE 00779	DRAWING NO C-5-1579008-0	RESTRICTED TO —		
		3 PLC ± —								
4 PLC ± —										
MATERIAL		FINISH		WEIGHT 0,000kg						
				CUSTOMER DRAWING				SCALE 1:1	SHEET 1 OF 1	REV B