



A Product Line of  
Diodes Incorporated



---

## **SPECIFICATION FOR APPROVAL**

CUSTOMER \_\_\_\_\_

NOMINAL FREQUENCY 27.000000 MHz



PRODUCT TYPE **TYPE FL 3.2x2.5 SEAM SEALED CRYSTAL**

SPEC. NO. ( P/N ) FL2700041

CUSTOMER P/N \_\_\_\_\_

ISSUE DATE January 4, 2018

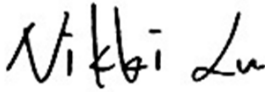
VERSION D

APPROVED	PREPARED	QA
		

### Diodes Incorporated

No.2, Ziqiang 5th Rd., Zhongli Industrial Park,  
Zhongli Dist., Taoyuan City 32063, Taiwan (R.O.C.)  
TEL: 886-3-451-8888  
FAX: 886-3-461-3865  
<https://www.diodes.com>

\*Pb-free  
\*RoHS Compliant  
\*HF-Halogen Free  
\*REACH Compliant



# TYPE FL 3.2x2.5 SEAM SEALED CRYSTAL

## FL2700041

VER. D 4-Jan-18

### ELECTRICAL SPECIFICATIONS

Item	Symbol	Specifications	Units	Notes
Nominal Frequency	Fn	27.000000	MHz	
Mode of Oscillation	MO	AT Cut-Fundamental		
Calibration Load Capacitance	CL	18	pF	
Calibration Tolerance	FL	±20	ppm	at 25°C±3°C
Operating Temperature Range	TR	-40 to +85	°C	
Frequency Stability (Frequency Deviation over the Operating Temperature Range)	F/T	±20	ppm	Reference to the Frequency at 25°C
Operating Drive Level		10	μW	
Maximum Drive Level		100	μW	
Equivalent Series Resistance	ESR	60	Ω	Max
Shunt Capacitance	C0	5	pF	Max
Aging at 25°C		±3	ppm	Max, 1st year
Storage Temperature		-55 to +125	°C	
Insulation Resistance		500	MΩ	Min

※ This product doesn't include harmful substance that stipulated by SONY SS-00259 Level 1 and S-AT2-001 Level 1 standard. RoHS Compliant (Pb - Free).

# TYPE FL 3.2x2.5 SEAM SEALED CRYSTAL

**FL2700041**

VER. D 4-Jan-18

## RELIABILITY SPECIFICATIONS

### MECHANICAL AND ENVIRONMENTAL RATINGS:

- a) FINE LEAK TEST: JESD22-A109 (Condition 1A)
- b) GROSS LEAK TEST: JESD22-A109 (Condition C)
- c) MOISTURE RESISTANCE: JESD22-A113
- d) SHOCK: JESD22-B104 (Condition B)
- e) SOLDERABILITY : (RoHS version): J-STD-002
- f) VIBRATION: JESD22-B103
- g) SOLVENT RESISTANCE: JESD22-B107
- h) RESISTANCE TO SOLDERING HEAT (RoHS version): J-STD-020D Table 5.2 Pb free devices (3 cycles max)

## SUGGESTED IR REFLOW PROFILE

\*As per IPC-JEDEC J-STD-020D

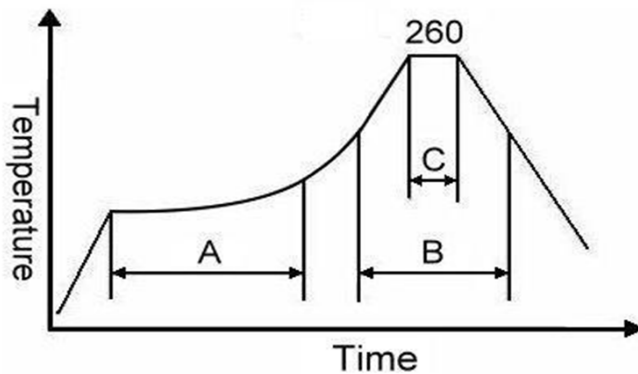

Note:

	Stage	Temperature	Time
A	Preheat	150~200°C	60~120 Sec
B	Primary Heat	217°C	60~150 Sec
C	Peak	260°C	10 Sec

# TYPE FL 3.2x2.5 SEAM SEALED CRYSTAL

**FL2700041**

VER. D 4-Jan-18

## MARKING

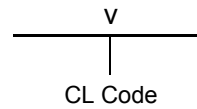
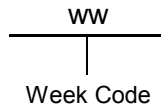
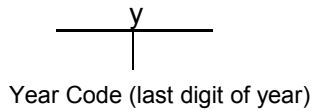

## MECHANICAL DRAWINGS ( Scale: None. Dimensions are in mm.)

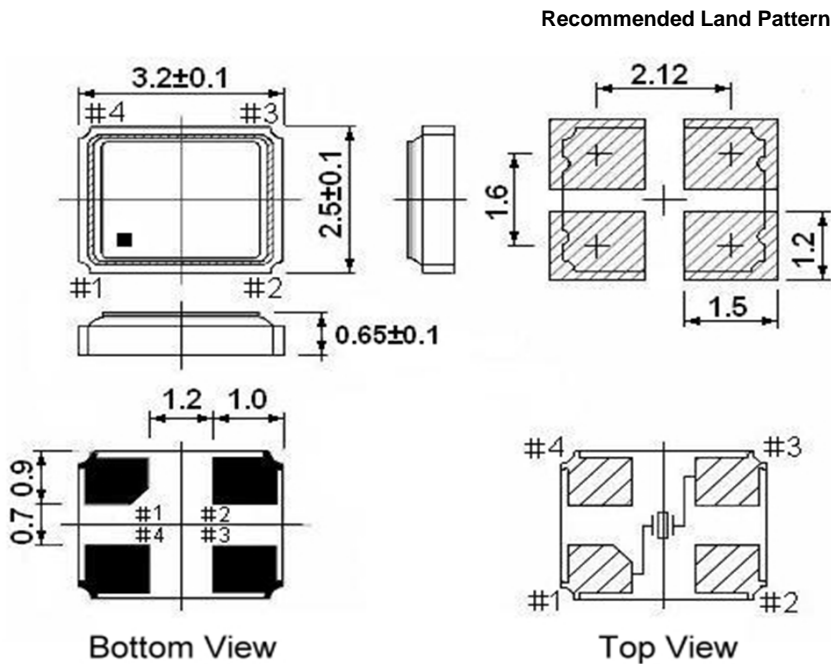

**\*\* Recommended - Pin 1 & 3 : CRYSTAL  
Pin 2 & 4 : GND**

**Notes:**

1. Package drawings are for reference only, and the appearances of objects may vary.  
Actual packages are based on the real product.
2. The marking dot denotes Pin#1.
3. The position and shape of the chamfer pin may vary and are based on the real product.



# TYPE FL 3.2x2.5 SEAM SEALED CRYSTAL

FL2700041

VER. D 4-Jan-18

## PACKING

