

# Datamate

## Contents

	Introduction	74
Datamate Mix-Tek: 2.00/4.00mm pitch High-Reliability Connectors		
	Specifications	76
	Power Connectors	78
	Power/Signal Connectors	85
	Coax Connectors	90
	Housings Only	95
	Contacts	102
	Metal Backshells	105
Datamate J-Tek: Jackscrew 2.00mm pitch High-Reliability Connectors		
	Specifications	108
	Female Connectors & Cable Assemblies	111
	Female T-Contact & Cable Assemblies	127
	Female Backshells	132
	Male Connectors & Cable Assemblies	133
	Male Backshells	149
	Flex Circuit Assemblies	150
Datamate J-Tek 3-Row: 2.00mm pitch High-Reliability Connectors		
	Specifications	151
	Female Connectors	152
	Male Connectors	155
Datamate L-Tek: Latched 2.00mm pitch High-Reliability Connectors		
	Specifications	157
	Female Connectors & Cable Assemblies	159
	Male Connectors	166
	Tooling	174

# Datamate Connectors Introduction

DATA  
MATE

Datamate is a 2mm pitch High-Reliability, high performance connector range from Harwin. The range has a proven track record for performance under extreme conditions, and complies with British Standard 9525-F0033.

Datamate provides a low-profile solution for all variations of cable-to-board, board-to-board and cable-to-cable interconnect requirements. The range has seen many developments to match customer and market demands, and now includes 1-, 2- and 3-row configurations, vertical and horizontal in both Throughboard and Surface Mount designs for PCB flexibility. To meet the demanding requirements of vibration, shock and acceleration, added security is available with the options of latches (for space-saving) or jackscrews (for maximum strain-relief).

With the addition of Datamate Mix-Tek, the 3A signal contacts can be supplied in the same connector as 20A power, 40A high power, or 6GHz coax connections, giving complete flexibility of design. Other range additions include the 101Lok fixing – designed for fast mating with a quarter-turn bayonet-style jackscrew.

- ❖ 3A per contact (all electrically loaded; 3.3A per individual contact)
- ❖ 4-finger contact design to maintain electrical contact through high vibration and shock
- ❖ Beryllium Copper Contact for improved temperature range: -55°C to +125°C
- ❖ 500 Mating cycles durability
- ❖ Professional connector system at commercial prices
- ❖ Ongoing development program for High-Reliability connectors from Harwin
- ❖ Online videos and Cable assembly facility for assistance with cabling requirements

## Datamate Signal

- ❖ Strong stainless steel jackscrew fixings for maximum strain relief, or lightweight space-saving locking latches
- ❖ Lightweight metal and plastic hood options for shielding and additional cable protection
- ❖ Choices of pre-wired contacts or full cable assemblies from stock, for prototyping and full production

## Datamate Mix-Tek

- ❖ Multiple variations of power-only, power-and-signal, or coax only variations of connectors, available from stock
- ❖ Full cable assembly options for coax and power, in 2/4/6/8 contact connectors on 4mm pitch
- ❖ Compatible with lightweight metal hoods for shielding and cable protection

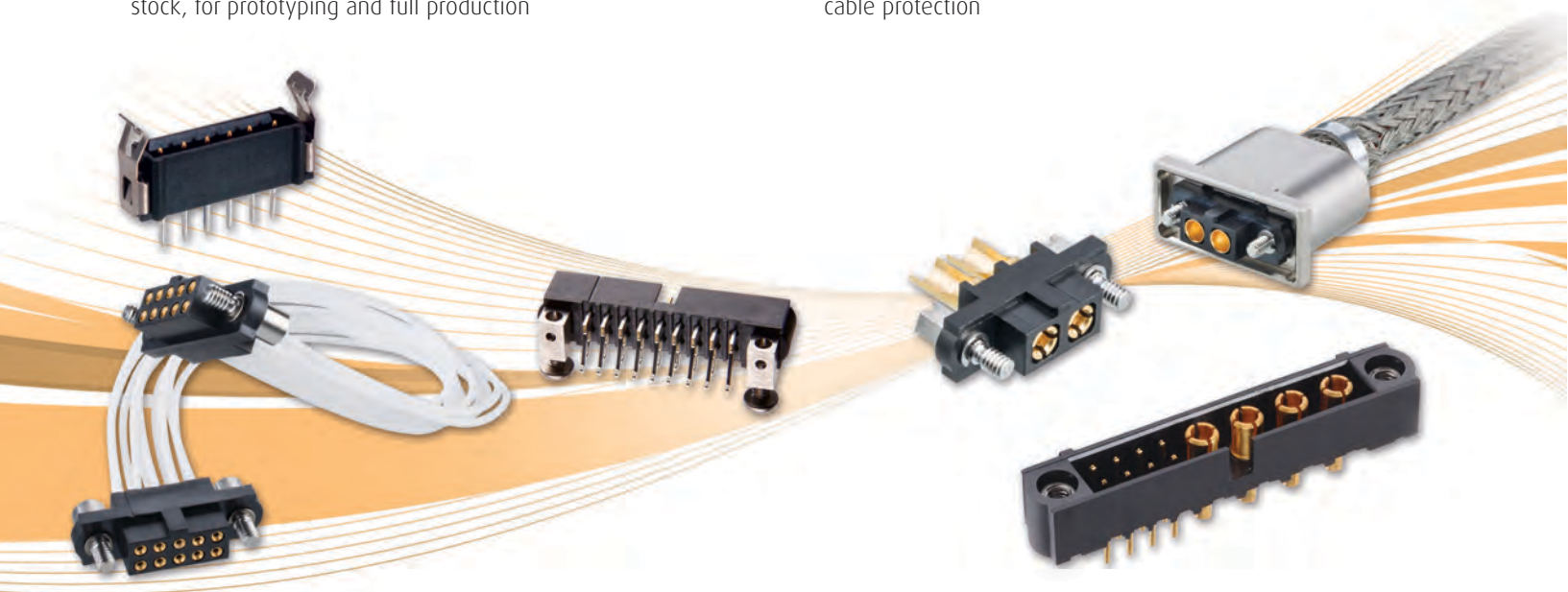

# Datamate Connectors Product Features

## Four Finger Beryllium Copper Contact

Proven high-reliability contact design ensures signal integrity under extremes of bump, vibration and shock. Durable to over 500 mating cycles.



## Polarization

All Datamate designs feature polarization to prevent mis-mating in everyday use.



## Rugged construction

For use in harsh environments where high vibration, shock and temperature are a consideration.

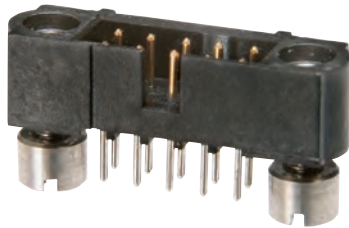

## Innovative fast-acting bayonet fixing

101Lok utilises a 101-degree turn to quickly and simply lock mating connectors together.



## Ready-made Cable Assemblies

Wide selection of stocked single and double-ended cable assemblies, with jackscrews or latching connectors, signal or power contacts.



## Single piece metal Backshells for EMC Shielding

Compatible with the J-Tek and Mix-Tek connector ranges, these robust hoods provide full 360° shielding, complete with retention feature on cable exit for fixing additional braiding.



## Low outgassing emissions

Plastic housings with outgassing emissions within NASA & ESA recommendations, ready for space and low-pressure research.



## Comprehensive Operating Temperature

All connectors suitable for operational temperatures from -55°C to +125°C, due to high quality material choice.

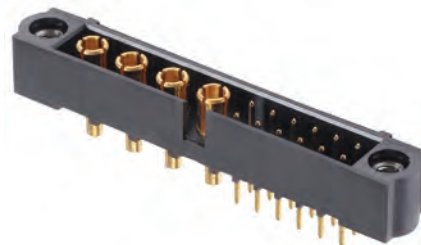

All dimensions in mm.

# Datamate Mix-Tek Specification

## Materials

Housings:	Glass-filled thermoplastic UL94V-0
Female contacts:	Brass shell, with Beryllium Copper inner contact
Male contacts:	Copper alloy
Finish:	See individual pages

## Electrical

<b>Current</b>	
Individual contacts in isolation:	3.3A max (at 25°C) 2.6A max (at 85°C)
All contacts simultaneously:	3.0A max (at 25°C) 2.2A max (at 85°C)
<b>Working voltage</b>	
At sea level 1013 mbar:	800V DC or AC <sub>rms</sub>
<b>Voltage proof</b>	
At sea level 1013 mbar:	1,200V DC or AC <sub>rms</sub>
<b>Contact resistance</b>	
Initial:	20mΩ max
After conditioning:	25mΩ max
<b>Insulation resistance</b>	
Initial:	1,000MΩ min
After conditioning:	100MΩ min

## Mechanical

Durability:	500 operations
Insertion force (max):	2.8N
Withdrawal force (min):	0.2N
Signal crimp accommodation:	22 AWG to 28 AWG BS 3G 210 Type A

## Environmental

Environmental classification:	55/125/56 days at 95% RH
Operational temperature:	-55°C to +125°C
*Vibration sensitivity:	10Hz to 2000Hz, 0.75mm, 98m/s <sup>2</sup> (10G), duration 6h
*Bump severity:	390m/s <sup>2</sup> (40G), 4000 ±10 bumps
*Shock severity:	981m/s <sup>2</sup> (100G) for 6ms
*Acceleration severity:	490m/s <sup>2</sup> (50G)

\* Tested with connectors with Jackscrews.

## Power Contacts

### Materials

Latching collar:	Beryllium Copper, Nickel plated
Other metallic parts:	Copper alloy, Gold plated

### Electrical

<b>Current (in isolation)</b>	
32x, 33x:	20A max
PFx, PMx:	40A nominal, up to 80A max
Contact resistance:	6mΩ max

### Mechanical

<b>Insertion force (max)</b>	
32x, 33x:	8N
PFx, PMx:	15N
Withdrawal force (min):	0.5N
<b>Contact replacement in connector:</b>	
	5 times
<b>Power contact accommodation</b>	
32x, 33x:	12 to 20 AWG
PFx, PMx:	10 AWG

All dimensions in mm.

## Coax Contacts

### Materials

Latching collar:	Beryllium Copper, Nickel plated
Other metallic parts:	Copper alloy, Gold plated
Insulator:	PTFE

### Electrical

Frequency range:	6GHz (depending on cable)
Impedance:	50Ω
VSWR:	1.05 + (0.04 x Frequency) GHz max
Operating voltage (sea level):	180V AC at 500mA
Maximum voltage (sea level):	1000V AC <sub>rms</sub>
Contact resistance:	6mΩ max
Insulation resistance:	10 <sup>6</sup> MΩ at 250V AC <sub>rms</sub>

### Mechanical

Insertion force (max):	20N
Withdrawal force (min):	0.5N
Contact replacement in connector:	5 times

# Datamate Mix-Tek Pin Numbering

	FEMALE	MALE
POWER OR COAX ONLY		
SIGNAL AND POWER		

## Mating Profiles

		FEMALE	
		VERTICAL THROUGHBOARD	CRIMP
MALE	VERTICAL THROUGHBOARD		
	HORIZONTAL THROUGHBOARD		
	CRIMP		

All dimensions in mm.

# Datamate Power Connectors

- Standard high-reliability connectors fitted with power contacts on 4mm pitch.

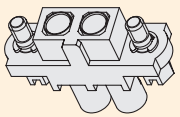
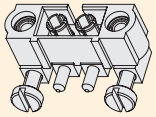
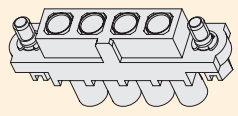
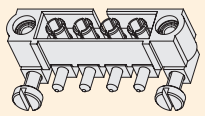
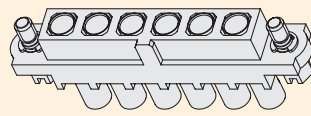
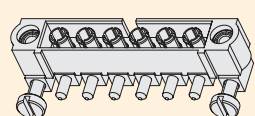
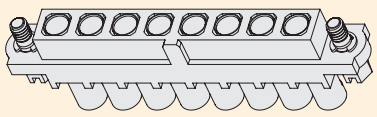
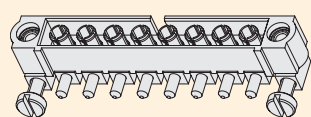
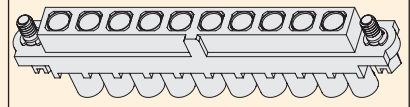
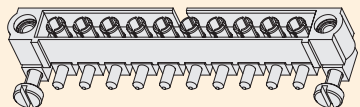
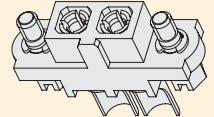
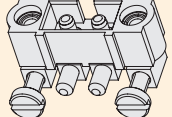
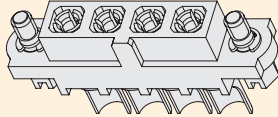
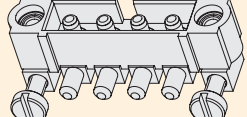
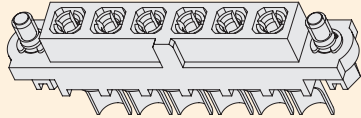
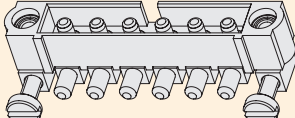
		TYPE		
		Cable Assemblies	Female Cable - Hex Slotted Jackscrews	Male Horizontal 3.5mm PC Tail - 5mm Board Mount Jackcrew
TOTAL NO. OF CONTACTS	<b>2 Power</b>	Female Single Ended (Female to Cut End) Hex Socket Jackscrews M80-FC325F1-02-0150L Male Single Ended (Male to Cut End) Jackscrew Fixing M80-MC335M1-02-0150L	 M80-4000000F1-02-325-00-000	 M80-5000000M5-02-333-00-000
	<b>4 Power</b>	Female Single Ended (Female to Cut End) Hex Socket Jackscrews M80-FC325F1-04-0150L Male Single Ended (Male to Cut End) Jackscrew Fixing M80-MC335M1-04-0150L	 M80-4000000F1-04-325-00-000	 M80-5000000M5-04-333-00-000
	<b>6 Power</b>	Female Single Ended (Female to Cut End) Hex Socket Jackscrews M80-FC325F1-06-0150L Male Single Ended (Male to Cut End) Jackscrew Fixing M80-MC335M1-06-0150L	 M80-4000000F1-06-325-00-000	 M80-5000000M5-06-333-00-000
	<b>8 Power</b>	Female Single Ended (Female to Cut End) Hex Socket Jackscrews M80-FC325F1-08-0150L Male Single Ended (Male to Cut End) Jackscrew Fixing M80-MC335M1-08-0150L	 M80-4000000F1-08-325-00-000	 M80-5000000M5-08-333-00-000
	<b>10 Power</b>		 M80-4000000F1-10-325-00-000	 M80-5000000M5-10-333-00-000
	<b>2 High Power</b>	Female Single Ended (Female to Cut End) Hex Socket Jackscrews M80-FCPF5F1-02-0150L Male Single Ended (Male to Cut End) Jackscrew Fixing M80-MCPM5M1-02-0150L	 M80-4000000F1-02-PF5-00-000	 M80-5000000M5-02-PM3-00-000
	<b>4 High Power</b>	Female Single Ended (Female to Cut End) Hex Socket Jackscrews M80-FCPF5F1-04-0150L Male Single Ended (Male to Cut End) Jackscrew Fixing M80-MCPM5M1-04-0150L	 M80-4000000F1-04-PF5-00-000	 M80-5000000M5-04-PM3-00-000
	<b>6 High Power</b>	Female Single Ended (Female to Cut End) Hex Socket Jackscrews M80-FCPF5F1-06-0150L Male Single Ended (Male to Cut End) Jackscrew Fixing M80-MCPM5M1-06-0150L	 M80-4000000F1-06-PF5-00-000	 M80-5000000M5-06-PM3-00-000
	<b>8 High Power</b>	Female Single Ended (Female to Cut End) Hex Socket Jackscrews M80-FCPF5F1-08-0150L Male Single Ended (Male to Cut End) Jackscrew Fixing M80-MCPM5M1-08-0150L		

All dimensions in mm.

# Datamate Power Connectors

Standard high-reliability connectors fitted with power contacts on 4mm pitch.

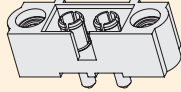
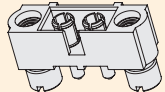
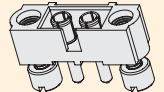
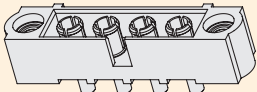
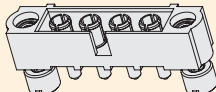
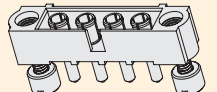
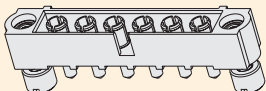
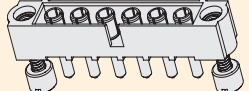
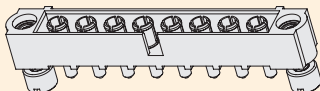
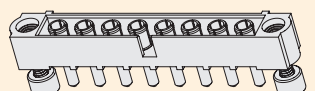
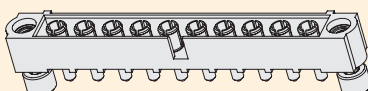
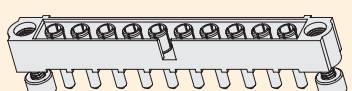
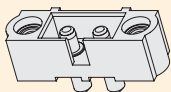
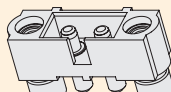
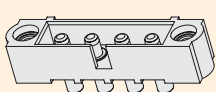
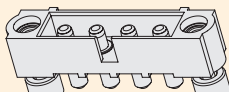
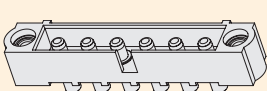
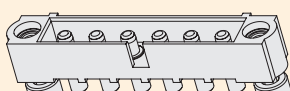
		TYPE		
		Male Vertical 3.5mm Tail - Jackscrew Fixing	Male Vertical 3.5mm Tail - 3.5mm Board Mount Jackcrew	Male Vertical 5mm Tail - 5mm Board Mount Jackcrew
TOTAL NO. OF CONTACTS	2 Power	 M80-5000000M1-02-331-00-000	 M80-5000000M2-02-331-00-000	 M80-5000000M3-02-332-00-000
	4 Power	 M80-5000000M1-04-331-00-000	 M80-5000000M2-04-331-00-000	 M80-5000000M3-04-332-00-000
	6 Power		 M80-5000000M2-06-331-00-000	 M80-5000000M3-06-332-00-000
	8 Power		 M80-5000000M2-08-331-00-000	 M80-5000000M3-08-332-00-000
	10 Power		 M80-5000000M2-10-331-00-000	 M80-5000000M3-10-332-00-000
	2 High Power	 M80-5000000M1-02-PM1-00-000	 M80-5000000M2-02-PM1-00-000	
	4 High Power	 M80-5000000M1-04-PM1-00-000	 M80-5000000M2-04-PM1-00-000	
	6 High Power	 M80-5000000M1-06-PM1-00-000	 M80-5000000M2-06-PM1-00-000	

All dimensions in mm.

# Datamate Power Connectors

## Female Power Cable Connector Kit

- Part numbers are for a complete kit of a housing and the applicable number of contacts.
- Hexagonal slotted jackscrews are assembled where specified.
- Polarized housings.
- Standard Power contacts rated to 20A, High Power to 40A.



DATAMATE POWER

POWER CONTACTS ONLY		CALCULATION		SPARE SOLDER CONTACTS	
<b>Standard Power (12 AWG)</b>		<b>A</b>	B + 14	<b>Standard Power (12 AWG)</b>	
		<b>B</b>	(No. of Power contacts - 1) x 4		
		<b>C</b>	B + 9		
<b>High Power (10 AWG)</b>				<b>High Power (10 AWG)</b>	
				<b>ORDER CODE</b> <b>M80-325</b>	
				<b>ORDER CODE</b> <b>M80-PF5</b>	
TOOLS		WIRE STRIPPING DETAILS			
<b>Contact Removal Tool</b> - Z80-290 No special tooling required for connecting wire, other than standard soldering equipment.					
HOW TO ORDER					
<b>M80 - 4000000F1 - XX - XXX - 00 - 000</b>					
<b>NO. OF POWER CONTACTS</b>				<b>POWER CONTACTS PART NO.</b>	
<b>02, 04, 06, 08, 10</b>	Standard Power			<b>325</b>	Standard Power
<b>02, 04, 06</b>	High Power			<b>PF5</b>	High Power

All dimensions in mm.



# Datamate Power Connectors

## Female Cable Assemblies

- Ready-made cable assemblies, fully tested and inspected.
- Standard Power contacts are rated to 20A, and are fitted with 12AWG, white PTFE-insulated cables.
- High Power are rated to 40A nominal, up to 80A max. Fitted with 10AWG, white PTFE-insulated cables.
- Cable assemblies are constructed with Contact A to Contact A, Contact B to Contact B, etc.



DATAMATE POWER

### STANDARD POWER

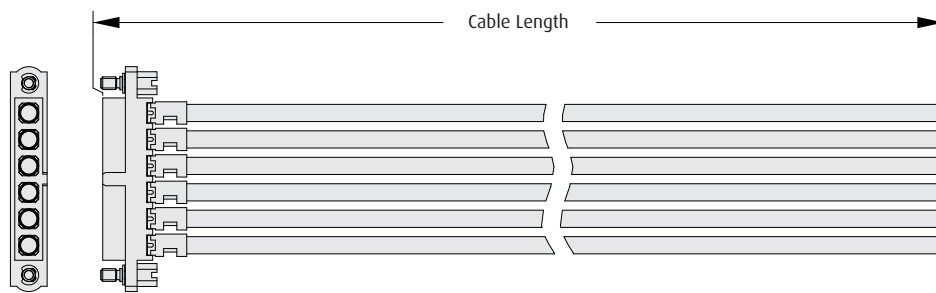

### HIGH POWER

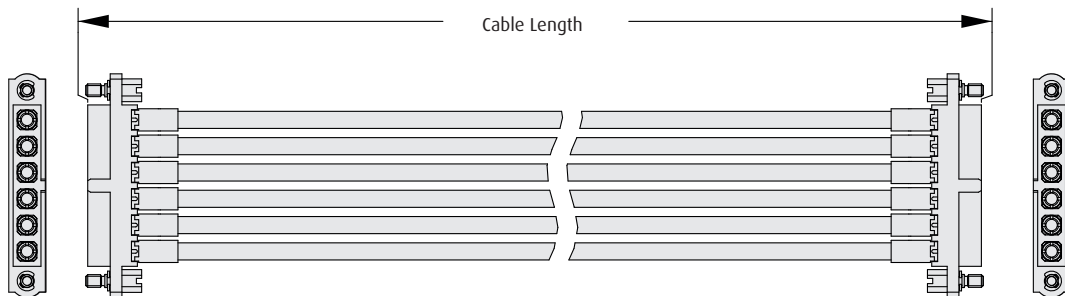

### HOW TO ORDER

**M80 - FC XXX F1 - XX - XXXX XX**

#### SERIES CODE

#### POWER CONTACTS PART NO.

<b>325</b>	Standard Power
<b>PF5</b>	High Power

#### JACKSCREW

<b>F1</b>	Hex Slotted Jackscrews
-----------	------------------------

#### TERMINATION - SECOND END

<b>L</b>	Loose cut end
<b>F1</b>	Female connector

#### CABLE LENGTH

<b>0150</b>	150mm
<b>XXXX</b>	XXXXmm

#### NO. OF POWER CONTACTS

**02, 04, 06, 08**

All dimensions in mm.

# Datamate Power Connectors

## Male Vertical Throughboard

- ❖ A selection of stocked Datamate Mix-Tek solder tail standard layouts.
- ❖ Choice to suit two PCB thicknesses and two stud lengths.
- ❖ Standard Power contacts rated to 20A.
- ❖ High Power rated to 40A nominal, up to 80A max.

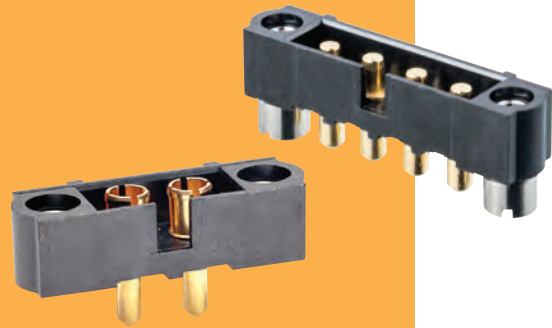

### STANDARD POWER

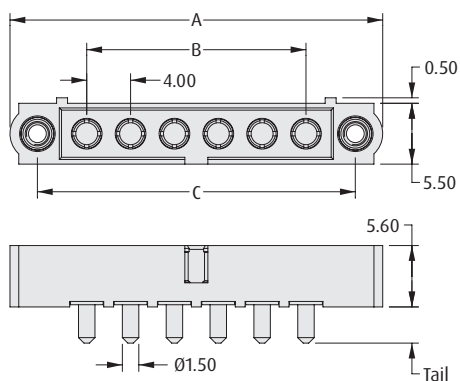

Jackscrew fixing

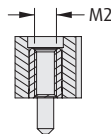

Jackscrew with Board Mount

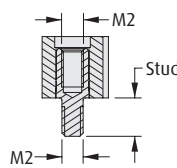

Recommended PC Board Pattern

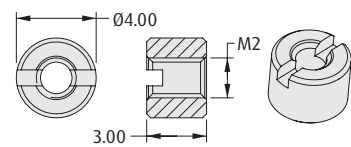
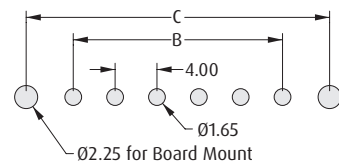

Board Mount Nut, 2 per connector

#### CALCULATION

<b>A</b>	$B + 14$
<b>B</b>	$(\text{No. of Power contacts} - 1) \times 4$
<b>C</b>	$B + 9$

### HIGH POWER

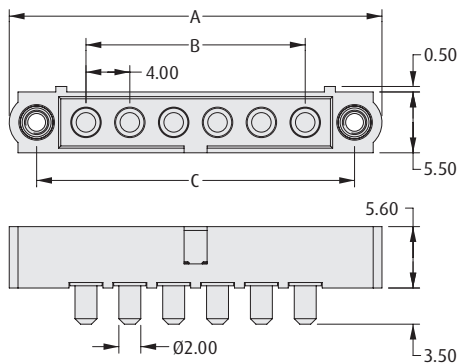

Jackscrew fixing

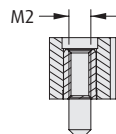

Jackscrew with Board Mount

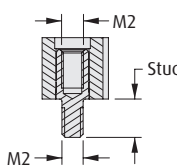

Recommended PC Board Pattern

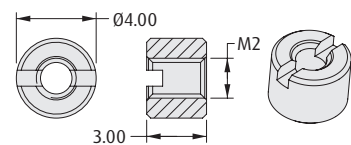
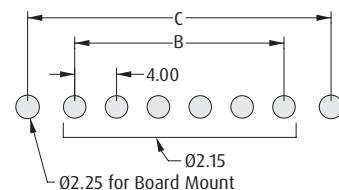

Board Mount Nut, 2 per connector

### HOW TO ORDER

**M80 - 5000000 XX - XX - XXX - 00 - 000**

#### JACKSCREW

<b>M1</b>	Jackscrew only
<b>M2</b>	With 3.5mm Board Mount stud
<b>M3</b>	With 5mm Board Mount stud

Check image chart to confirm Off-The-Shelf sizes available

#### NO. OF POWER CONTACTS

<b>02, 04</b>	Standard Power (M1 Jackscrews)
<b>02, 04, 06, 08, 10</b>	Standard Power (M2/M3 Jackscrews)
<b>02, 04, 06</b>	High Power (M1/M2 Jackscrews)

#### POWER CONTACTS PART NO.

<b>331</b>	3.5mm Tail Standard Power
<b>332</b>	5mm Tail Standard Power
<b>PM1</b>	3.5mm Tail High Power

All dimensions in mm.

# Datamate Power Connectors

## Male Horizontal Throughboard

- Choice to suit two PCB thicknesses and two stud lengths.
- Standard Power contacts rated to 20A.
- High Power rated to 40A nominal, up to 80A max.



### STANDARD POWER

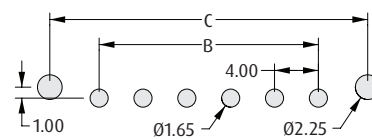
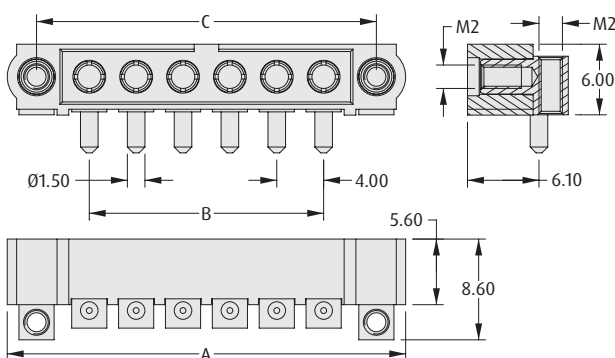

Recommended PC Board Pattern

Board Mount Bolt,  
2 per connector

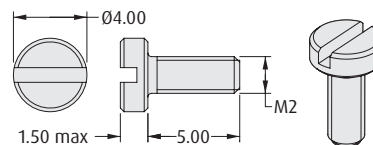

### CALCULATION

<b>A</b>	$B + 14$
<b>B</b>	$(\text{No. of Power contacts} - 1) \times 4$
<b>C</b>	$B + 9$

### HIGH POWER

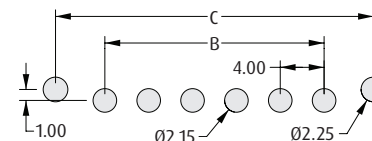
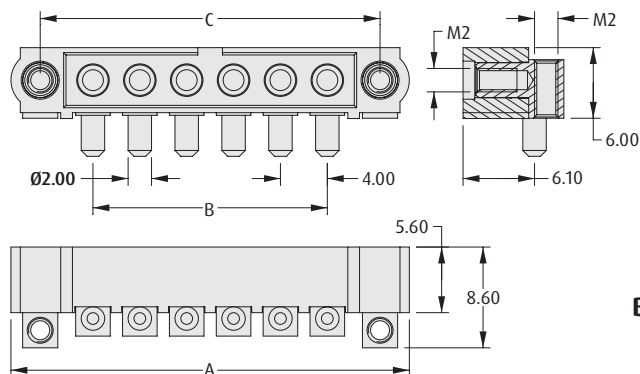

Recommended PC Board Pattern

Board Mount Bolt,  
2 per connector

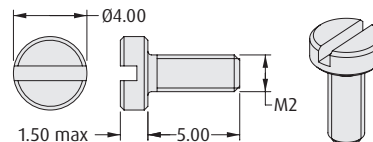

### HOW TO ORDER

**M80 - 500000 M5 - XX - XXX - 00 - 000**

NO. OF POWER CONTACTS	
02, 04, 06, 08, 10	Standard Power
02, 04, 06,	High Power

POWER CONTACTS PART NO.	
333	3.5mm Tail Standard Power
PM3	3.5mm Tail High Power

All dimensions in mm.

# Datamate Power Connectors

## Male Cable Assemblies

- ❖ Ready-made cable assemblies, fully tested and inspected.
- ❖ Standard Power contacts are rated to 20A, and are fitted with 12AWG, white PTFE-insulated cables.
- ❖ High Power are rated to 40A nominal, up to 80A max. Fitted with 10AWG, white PTFE-insulated cables.
- ❖ Cable assemblies are constructed with Contact A to Contact A, Contact B to Contact B, etc.



### MALE SINGLE-ENDED

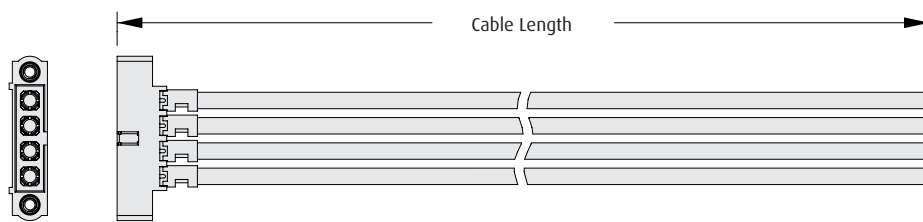

### MALE - FEMALE

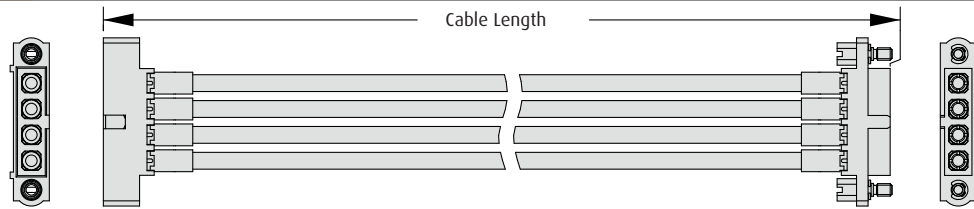

### MALE - MALE

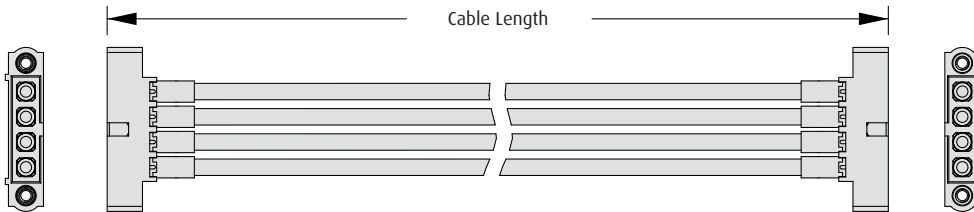

### HOW TO ORDER

**M80 - MC XXX M1 - XX - XXXX XX**

**SERIES CODE**

**POWER CONTACTS PART NO.**

<b>335</b>	Standard Power
<b>PM5</b>	High Power

**JACKSCREW**

<b>M1</b>	Internal Jackscrews
-----------	---------------------

**TERMINATION - SECOND END**

<b>L</b>	Loose cut end
<b>F1</b>	Female (Floating Hex Slotted Jackscrew)
<b>M1</b>	Male connector

**CABLE LENGTH**

<b>0150</b>	150mm
<b>XXXX</b>	XXXXmm

**NO. OF POWER CONTACTS**

**02, 04, 06, 08**

All dimensions in mm.

# Datamate Power/Signal Connectors

- Standard high-reliability connectors fitted with a combination of signal and 20A power contacts.

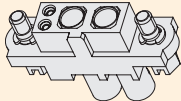
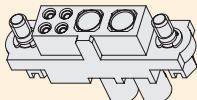
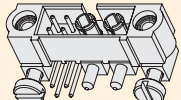
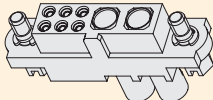
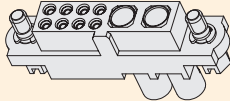
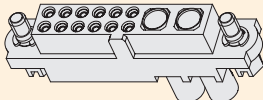
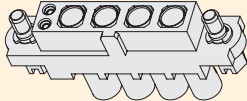
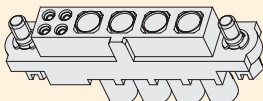
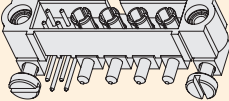
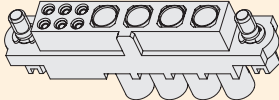
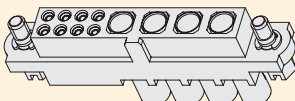
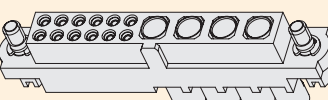
		TYPE	
		Female Cable - Hex Slotted Jackscrews	Male Horizontal 3mm Tail - 5mm Board Mount Jackcrew
TOTAL NO. OF CONTACTS	2 Power	 <p>M80-4C10205F1-02-325-00-000</p>	
	4 Signal	 <p>M80-4C10405F1-02-325-00-000</p>	 <p>M80-5L10405M5-02-333-00-000</p>
	6 Signal	 <p>M80-4C10605F1-02-325-00-000</p>	
	8 Signal	 <p>M80-4C10805F1-02-325-00-000</p>	
	12 Signal	 <p>M80-4C11205F1-02-325-00-000</p>	
TOTAL NO. OF CONTACTS	4 Power	 <p>M80-4C10205F1-04-325-00-000</p>	
	4 Signal	 <p>M80-4C10405F1-04-325-00-000</p>	 <p>M80-5L10405M5-04-333-00-000</p>
	6 Signal	 <p>M80-4C10605F1-04-325-00-000</p>	
	8 Signal	 <p>M80-4C10805F1-04-325-00-000</p>	
	12 Signal	 <p>M80-4C11205F1-04-325-00-000</p>	

All dimensions in mm.

# Datamate Power/Signal Connectors

DATAMATE POWER/SIGNAL

- Standard high-reliability connectors fitted with a combination of signal and 20A power contacts.

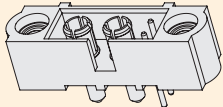
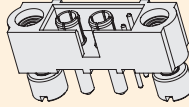
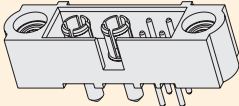
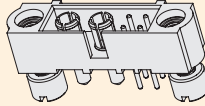
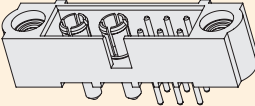
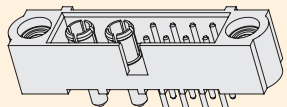
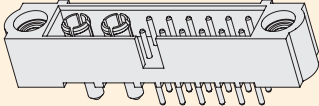
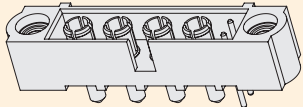
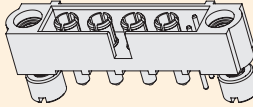
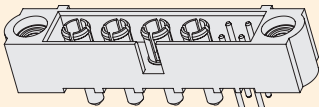
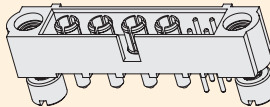
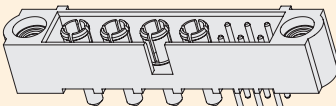
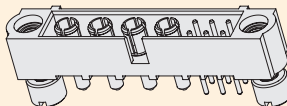
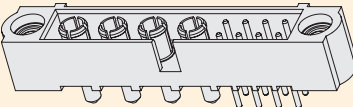
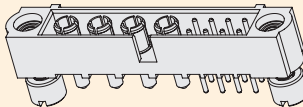
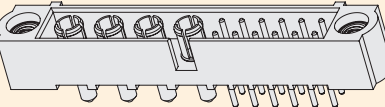
		TYPE	
		Male Vertical 3mm Tail - Jackscrew fixing	Male Vertical 3mm Tail - 3.5mm Board Mount Jackcrew
TOTAL NO. OF CONTACTS	2 Power	2 Signal  M80-5T10205M1-02-331-00-000	2 Signal  M80-5T10205M2-02-331-00-000
		4 Signal  M80-5T10405M1-02-331-00-000	4 Signal  M80-5T10405M2-02-331-00-000
		6 Signal  M80-5T10605M1-02-331-00-000	
		8 Signal  M80-5T10805M1-02-331-00-000	
		12 Signal  M80-5T11205M1-02-331-00-000	
	4 Power	2 Signal  M80-5T10205M1-04-331-00-000	2 Signal  M80-5T10205M2-04-331-00-000
		4 Signal  M80-5T10405M1-04-331-00-000	4 Signal  M80-5T10405M2-04-331-00-000
		6 Signal  M80-5T10605M1-04-331-00-000	6 Signal  M80-5T10605M2-04-331-00-000
		8 Signal  M80-5T10805M1-04-331-00-000	8 Signal  M80-5T10805M2-04-331-00-000
		12 Signal  M80-5T11205M1-04-331-00-000	

All dimensions in mm.

# Datamate Power/Signal Connectors

## Female Power/Signal Cable Connector Kit

- ❖ Part numbers are for a complete kit of a housing and the applicable number of contacts.
- ❖ Hexagonal slotted jackscrews are assembled.
- ❖ Polarized housings.
- ❖ Standard Power contacts rated to 20A, signal to 3A.



DATAMATE POWER/SIGNAL

SIGNAL AND POWER	CALCULATION	SPARE CONTACTS						
	<table border="1"> <tr> <td><b>A</b></td> <td>B + 13</td> </tr> <tr> <td><b>B</b></td> <td>(No. of Power contacts - 1) x 4 + Total no. of Signal contacts + 1</td> </tr> <tr> <td><b>C</b></td> <td>B + 8</td> </tr> </table>	<b>A</b>	B + 13	<b>B</b>	(No. of Power contacts - 1) x 4 + Total no. of Signal contacts + 1	<b>C</b>	B + 8	<p><b>Signal (24 to 28 AWG)</b></p> <p>Indent Groove</p> <p style="background-color: #f4a460; padding: 2px;"><b>ORDER CODE</b> M80-0130005</p> <p><b>Standard Power (12 AWG)</b></p> <p style="background-color: #f4a460; padding: 2px;"><b>ORDER CODE</b> M80-325</p>
	<b>A</b>	B + 13						
	<b>B</b>	(No. of Power contacts - 1) x 4 + Total no. of Signal contacts + 1						
<b>C</b>	B + 8							
<p><b>TOOLS</b></p> <p><b>Recommended Crimp Tool (Signal)</b> - M22520/2-01  <b>Positioner (Signal)</b> - T5747  <b>Contact Insertion/Removal Tool (Signal)</b> - Z80-280  <b>Contact Removal Tool (Power)</b> - Z80-290</p> <ul style="list-style-type: none"> <li>❖ No special tooling required for connecting Power wire, other than standard soldering equipment.</li> <li>❖ Instruction sheets available at <a href="http://www.harwin.com/instructions">www.harwin.com/instructions</a>.</li> </ul>	<p><b>WIRE STRIPPING DETAILS</b></p>							
<p><b>HOW TO ORDER</b></p> <p style="font-size: 1.2em; font-weight: bold;">M80 - 4C1 <u>XX</u> 05F1 - <u>XX</u> - 325 - 00 - 000</p> <table border="1" style="width: 100%; border-collapse: collapse;"> <tr> <td style="width: 30%; background-color: #f4a460; padding: 5px;"><b>NO. OF SIGNAL CONTACTS</b></td> <td style="width: 40%;"></td> <td style="width: 30%; background-color: #f4a460; padding: 5px;"><b>NO. OF POWER CONTACTS</b></td> </tr> <tr> <td style="background-color: #f4a460; padding: 5px;">02, 04, 06, 08, 12</td> <td></td> <td style="background-color: #f4a460; padding: 5px;">02, 04</td> </tr> </table> <p style="font-size: 0.8em;">Check image chart to confirm Off-The-Shelf sizes available</p>			<b>NO. OF SIGNAL CONTACTS</b>		<b>NO. OF POWER CONTACTS</b>	02, 04, 06, 08, 12		02, 04
<b>NO. OF SIGNAL CONTACTS</b>		<b>NO. OF POWER CONTACTS</b>						
02, 04, 06, 08, 12		02, 04						

All dimensions in mm.

# Datamate Power/Signal Connectors

## Male Power/Signal Vertical Throughboard

- A selection of stocked Datamate Mix-Tek solder tail standard layouts.
- Choice to suit two PCB thicknesses and two stud lengths.
- Polarized housings.
- Standard Power contacts rated to 20A, signal to 3A.

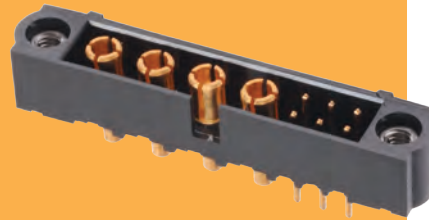

### JACKSCREW ONLY

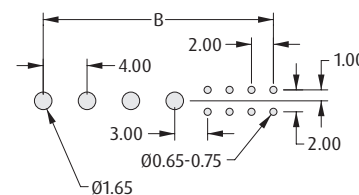
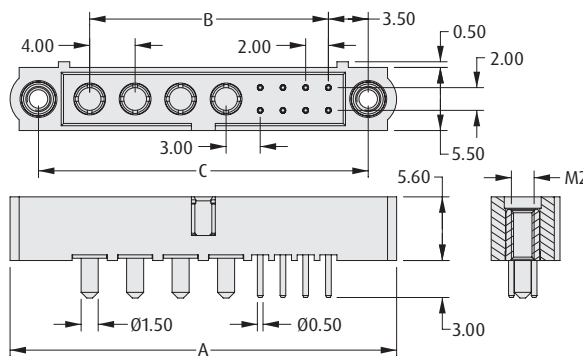

Recommended PC Board Pattern

#### CALCULATION

<b>A</b>	$B + 13$
<b>B</b>	(No. of Power contacts - 1) x 4 + Total no. of Signal contacts + 1
<b>C</b>	$B + 8$

### WITH BOARD MOUNT

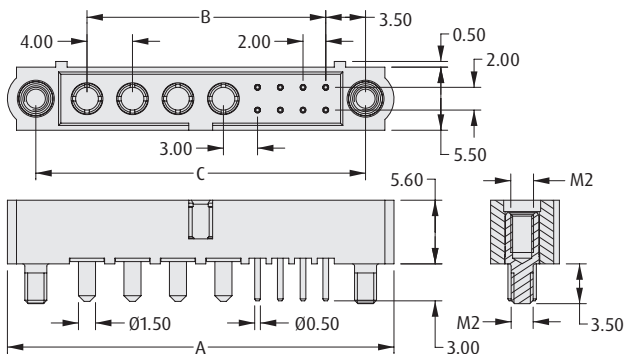

#### Board Mount Nut, 2 per connector

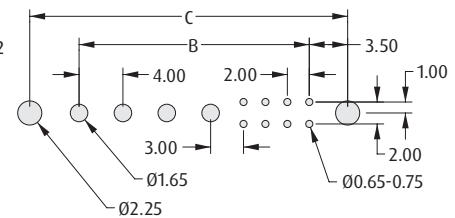
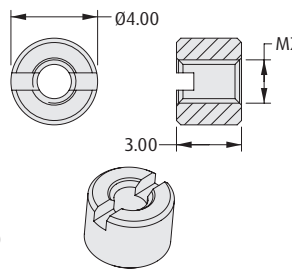

Recommended PC Board Pattern

### HOW TO ORDER

**M80 - 5T1 XX 05 XX - XX - 331 - 00 - 000**

#### NO. OF SIGNAL CONTACTS

02, 04, 06, 08, 12

#### NO. OF POWER CONTACTS

02, 04

#### JACKSCREW

<b>M1</b>	Jackscrew only
<b>M2</b>	With 3.5mm Board Mount stud

Check image chart to confirm Off-The-Shelf sizes available

All dimensions in mm.



# Datamate Power/Signal Connectors

## Male Power/Signal Horizontal Throughboard

- ❖ A selection of stocked Datamate Mix-Tek solder tail standard layouts.
- ❖ Polarized housings.
- ❖ Standard Power contacts rated to 20A, signal to 3A.



DATAMATE POWER/SIGNAL

### SIGNAL AND POWER

### CALCULATION

<b>A</b>	$B + 13$
<b>B</b>	$(\text{No. of Power contacts} - 1) \times 4 + \text{Total no. of Signal contacts} + 1$
<b>C</b>	$B + 8$

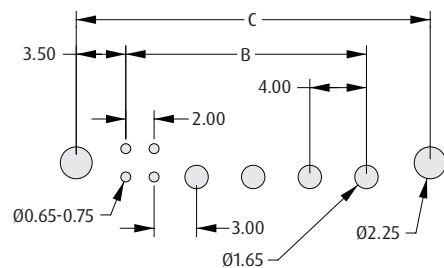
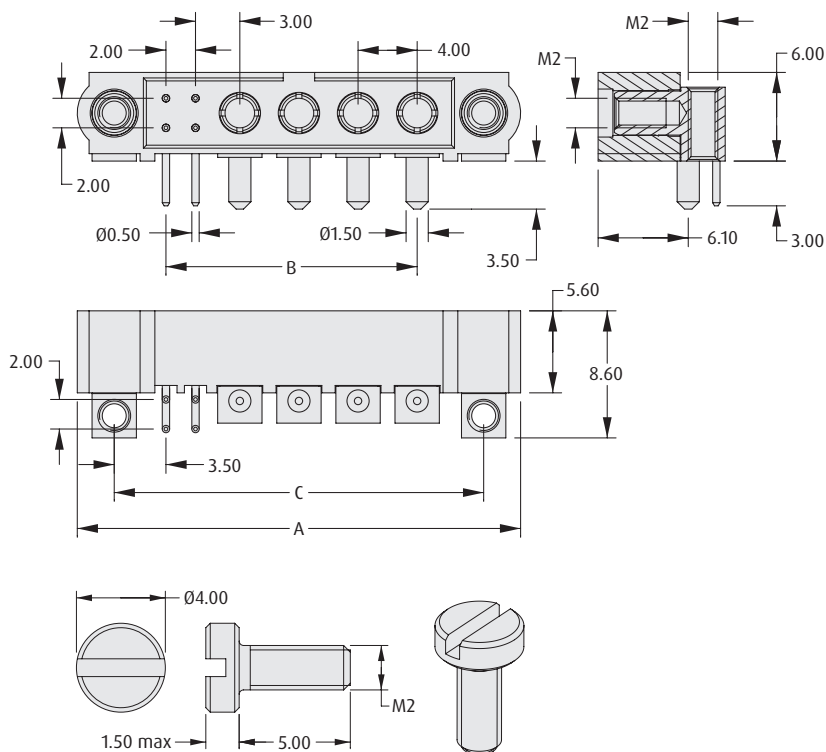

Recommended PC Board Pattern

**Board Mount Bolt, 2 per connector**

### HOW TO ORDER

**M80 - 5L1 04 05 M5 - XX - 333 - 00 - 000**

NO. OF SIGNAL CONTACTS

04

NO. OF POWER CONTACTS

02, 04

All dimensions in mm.

# Datamate Coax Connectors

- Standard high-reliability connectors fitted with coax contacts on 4mm pitch.

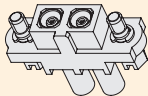
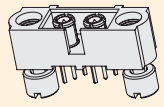
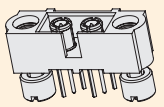
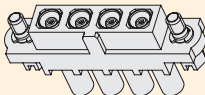
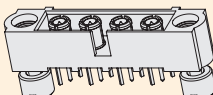
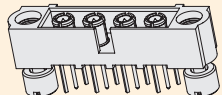
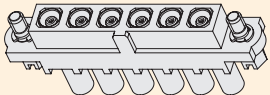
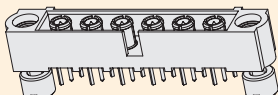
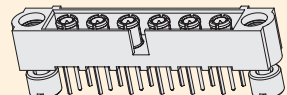
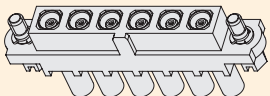
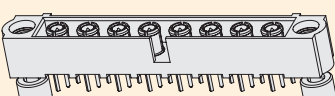
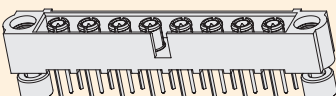
		TYPE		
		Female Cable Connectors - Hex Slotted Jackscrews	Male Vertical 3mm Tail - 3.5mm Board Mount Jackcrew	Male Vertical 4.5mm Tail - 5mm Board Mount Jackcrew
TOTAL NO. OF CONTACTS	2 Coax	 M80-FC305F1-02	 M80-MV311M2-02	 M80-MV312M3-02
	4 Coax	 M80-FC305F1-04	 M80-MV311M2-04	 M80-MV312M3-04
	6 Coax	 M80-FC305F1-06	 M80-MV311M2-06	 M80-MV312M3-06
	8 Coax	 M80-FC305F1-08	 M80-MV311M2-08	 M80-MV312M3-08

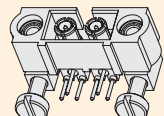
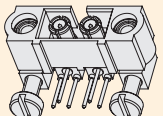
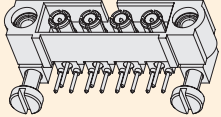
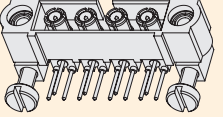
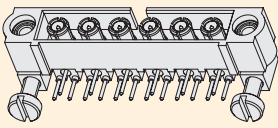
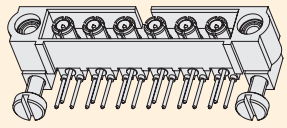
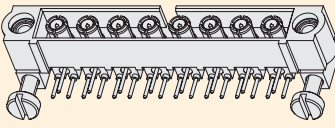
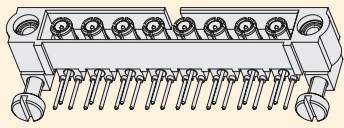
		TYPE		
		Female Cable Assemblies - Hex Slotted Jackscrews	Male Horizontal 3mm Tail - 5mm Board Mount Jackcrew	Male Horizontal 4.5mm Tail - 5mm Board Mount Jackcrew
TOTAL NO. OF CONTACTS	2 Coax	Single Ended (Female to Cut End) M80-FC305F1-02-0150L Double Ended (Female to Female) M80-FC305F1-02-0150F1	 M80-MH313M5-02	 M80-MH314M5-02
	4 Coax	Single Ended (Female to Cut End) M80-FC305F1-04-0150L Double Ended (Female to Female) M80-FC305F1-04-0150F1	 M80-MH313M5-04	 M80-MH314M5-04
	6 Coax	Single Ended (Female to Cut End) M80-FC305F1-06-1050L Double Ended (Female to Female) M80-FC305F1-06-0150F1	 M80-MH313M5-06	 M80-MH314M5-06
	8 Coax	Single Ended (Female to Cut End) M80-FC305F1-08-0150L Double Ended (Female to Female) M80-FC305F1-08-0150F1	 M80-MH313M5-08	 M80-MH314M5-08

# Datamate Coax Connectors

## Jack (Female) Crimp Kit

- ❖ A selection of stocked jack cable connectors in standard layouts.
- ❖ 6GHz, 50Ω Coax contacts, suitable for RG178 cable.
- ❖ Product supplied as a complete kit; housing with jackscrews assembled, and the applicable number of coax contacts supplied loose, not assembled.
- ❖ Polarized housings.
- ❖ Hexagonal slotted jackscrew style.

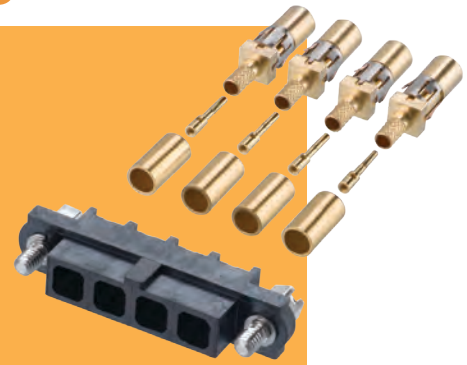

DATAMATE COAX

CABLE	CALCULATION	SPARE COAX CONTACTS							
	<table border="1"> <tr> <td><b>A</b></td> <td><math>B + 14</math></td> </tr> <tr> <td><b>B</b></td> <td><math>(\text{No. of Coax contacts} - 1) \times 4</math></td> </tr> <tr> <td><b>C</b></td> <td><math>B + 9</math></td> </tr> </table>	<b>A</b>	$B + 14$	<b>B</b>	$(\text{No. of Coax contacts} - 1) \times 4$	<b>C</b>	$B + 9$		
<b>A</b>	$B + 14$								
<b>B</b>	$(\text{No. of Coax contacts} - 1) \times 4$								
<b>C</b>	$B + 9$								
		<table border="1"> <tr> <td style="background-color: #f4a460;"><b>ORDER CODE</b></td> </tr> <tr> <td><b>M80-305</b></td> </tr> </table>	<b>ORDER CODE</b>	<b>M80-305</b>					
<b>ORDER CODE</b>									
<b>M80-305</b>									
TOOLS	WIRE STRIPPING DETAILS								
<p><b>Recommended Inner Contact Crimp Tool</b> - Z80-292</p> <p><b>Positioner for Inner Contact</b> - Z80-291</p> <p><b>Recommended Outer Sleeve Crimp Tool</b> - Z80-293</p> <p><b>Contact Removal Tool</b> - Z80-290</p> <p>❖ Instruction sheets available at <a href="http://www.harwin.com/instructions">www.harwin.com/instructions</a>.</p>									
HOW TO ORDER									
<p><b>M80 - FC 305 F1 - XX</b></p>									
<table border="1"> <tr> <th colspan="2" style="background-color: #f4a460;">COAX CONTACT TYPE</th> </tr> <tr> <td style="background-color: #f4a460;"><b>305</b></td> <td>Ø2.00mm cable</td> </tr> </table>	COAX CONTACT TYPE		<b>305</b>	Ø2.00mm cable	<table border="1"> <tr> <th colspan="2" style="background-color: #f4a460;">NO. OF COAX CONTACTS</th> </tr> <tr> <td style="background-color: #f4a460;"><b>02, 04, 06, 08</b></td> <td></td> </tr> </table>	NO. OF COAX CONTACTS		<b>02, 04, 06, 08</b>	
COAX CONTACT TYPE									
<b>305</b>	Ø2.00mm cable								
NO. OF COAX CONTACTS									
<b>02, 04, 06, 08</b>									

All dimensions in mm.

# Datamate Coax Connectors

## Jack (Female) Cable Assemblies

- A selection of stocked ganged multiport coax cable assemblies in standard layouts (custom also available).
- 6GHz, 50Ω Coax contacts, assembled with RG178 cable.
- Hexagonal slotted jackscrew style.
- Cable assemblies are constructed with Contact A to Contact A, Contact B to Contact B, etc.



### FEMALE SINGLE ENDED

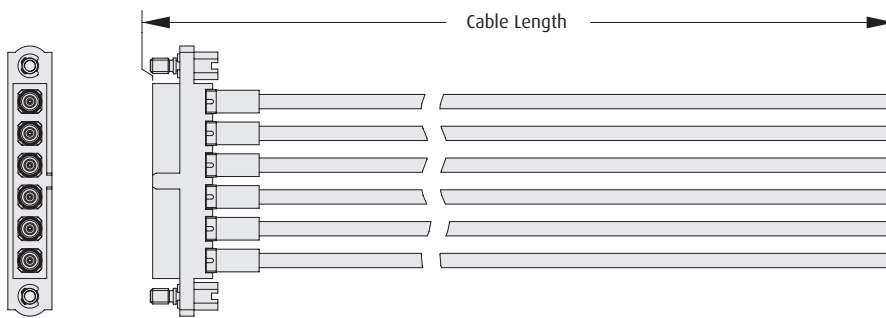

### FEMALE - FEMALE

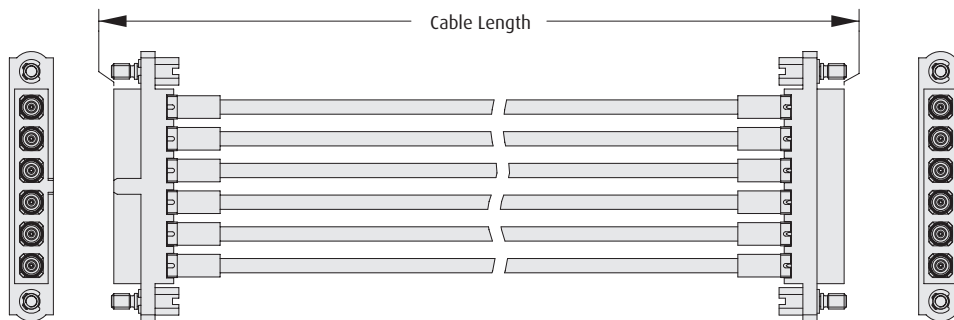

### HOW TO ORDER

**M80 - FC305F1 - XX - XXXX XX**

**SERIES CODE**

**NO. OF POWER CONTACTS**

02, 04, 06, 08

TERMINATION - SECOND END	
<b>L</b>	Loose cut end
<b>F1</b>	Female connector

**CABLE LENGTH**

<b>0150</b>	150mm
<b>0300</b>	300mm
<b>0450</b>	450mm
<b>XXXX</b>	XXXXmm

All dimensions in mm.

# Datamate Coax Connectors

## Plug (Male) Vertical Throughboard

- Stocked coax connectors in vertical orientation, with board-mount jackscrews for added security.
- 6GHz, 50Ω Coax contacts.
- Choice to suit two PCB thicknesses.
- Order board mount nuts separately.
- Screwdriver **Z80-298** available for assembling slotted jackscrew nuts.



### VERTICAL

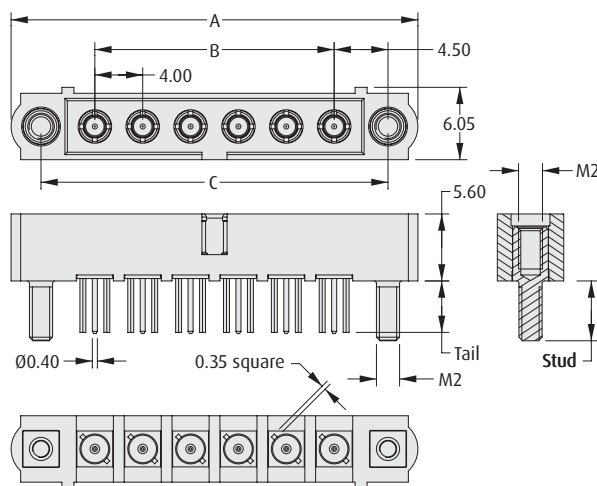

### CALCULATION

<b>A</b>	$B + 14$
<b>B</b>	$(\text{No. of Coax contacts} - 1) \times 4$
<b>C</b>	$B + 9$

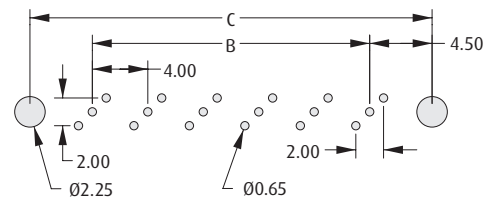

Recommended PCB Board Pattern

### HOW TO ORDER

**M80 - MV 3XX MX - XX**

TYPE	
<b>311M2</b>	3mm Tail with 3.5mm Board Mount Stud
<b>312M3</b>	4.5mm Tail with 5mm Board Mount Stud

NO. OF COAX CONTACTS
<b>02, 04, 06, 08</b>

### REQUIRED HARDWARE

Order separately from connector

#### Slotted Board Mount Nut

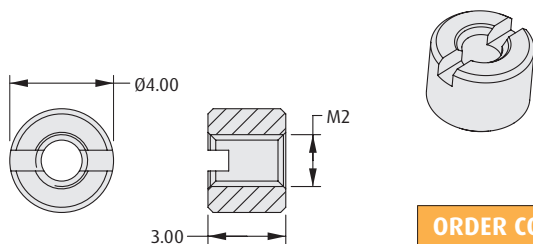

**ORDER CODE**  
**M80-2130000B**

#### Hexagonal Board Mount Nut

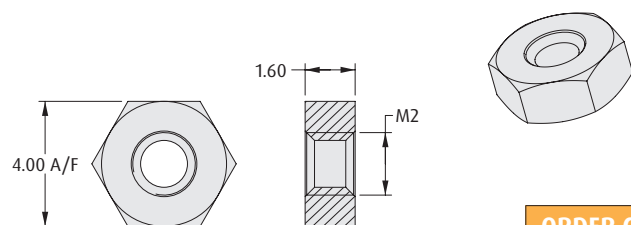

**ORDER CODE**  
**M80-2430000B**

All dimensions in mm.

# Datamate Coax Connectors

## Plug (Male) Horizontal Throughboard

- ❖ Stocked coax connectors in horizontal orientation, with board-mount jackscrews for added security.
- ❖ 6GHz, 50Ω Coax contacts.
- ❖ Choice to suit two PCB thicknesses.
- ❖ Order board mount bolts separately.

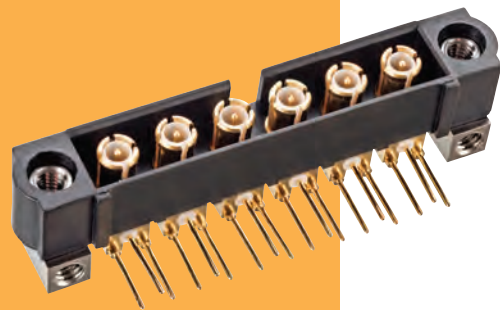

### HORIZONTAL

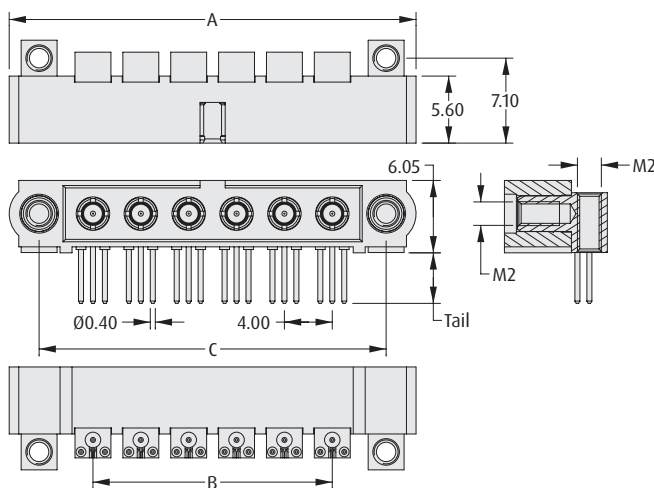

### CALCULATION

<b>A</b>	B + 14
<b>B</b>	(No. of Coax contacts - 1) x 4
<b>C</b>	B + 9

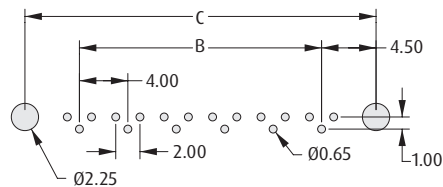

Recommended PCB Board Pattern

### HOW TO ORDER

**M80 - MH 3XX M5 - XX**

TYPE	
313	3mm Tail
314	4.5mm Tail

NO. OF COAX CONTACTS
02, 04, 06, 08

### REQUIRED HARDWARE

Order separately from connector

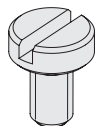
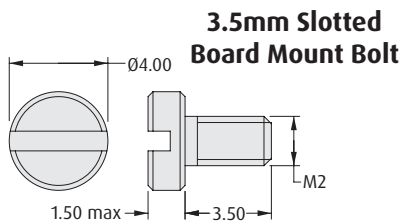

**ORDER CODE**  
M80-2260000B

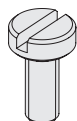
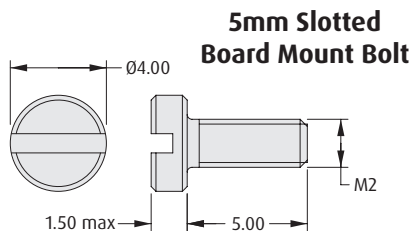

**ORDER CODE**  
M80-2270000B

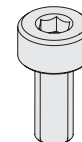
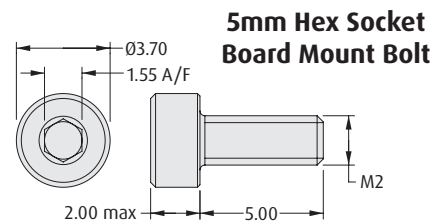

**ORDER CODE**  
M80-2320000B

All dimensions in mm.

# Datamate Mix-Tek Housings

- ❖ Housings only for cable connections, suitable for use with all power, high power and coax contacts. Contacts to be ordered separately.

MIXED TECHNOLOGY HOUSINGS - FEMALE, HEX SLOTTED JACKSCREWS				
	2 Power/Coax	3 Power/Coax	4 Power/Coax	6 Power/Coax
<b>2 Signal</b>			M80-263F104-02-00	M80-263F106-02-00
<b>4 Signal</b>			M80-263F104-04-00	
<b>6 Signal</b>	M80-263F102-06-00			
<b>8 Signal</b>	M80-263F102-08-00	M80-263F103-08-00		
<b>12 Signal</b>			M80-263F104-12-00	

POWER/COAX ONLY HOUSINGS - STANDARD GENDER JACKSCREWS				
	Female Hex Slotted floating	Female Hex Socket floating	Female Guide Pin panel mount	Male Internal jackscrew
<b>2 Contact</b>	M80-263F102-00-00	M80-263F202-00-00	M80-263F302-00-00	M80-273M102-00-00
<b>3 Contact</b>	M80-263F103-00-00	M80-263F203-00-00	M80-263F303-00-00	M80-273M103-00-00
<b>4 Contact</b>	M80-263F104-00-00	M80-263F204-00-00	M80-263F304-00-00	M80-273M104-00-00
<b>6 Contact</b>	M80-263F106-00-00	M80-263F206-00-00	M80-263F306-00-00	M80-273M106-00-00
<b>8 Contact</b>	M80-263F108-00-00	M80-263F208-00-00	M80-263F308-00-00	M80-273M108-00-00
<b>10 Contact</b>	M80-263F110-00-00			

POWER/COAX ONLY HOUSINGS				
	REVERSE FIX JACKSCREWS		101LOK	
	Female 5mm panel mount	Male Slotted floating	Female	Male
<b>2 Contact</b>	M80-263F902-00-00	M80-273MA02-00-00	M80-263FC02-00-00	M80-273MC02-00-00
<b>3 Contact</b>	M80-263F903-00-00	M80-273MA03-00-00	M80-263FC03-00-00	M80-273MC03-00-00
<b>4 Contact</b>	M80-263F904-00-00	M80-273MA04-00-00	M80-263FC04-00-00	M80-273MC04-00-00
<b>6 Contact</b>	M80-263F906-00-00	M80-273MA06-00-00	M80-263FC06-00-00	M80-273MC06-00-00
<b>8 Contact</b>	M80-263F908-00-00	M80-273MA08-00-00	M80-263FC08-00-00	M80-273MC08-00-00

# Datamate Mix-Tek Housings

## Female Mixed Technology Cable Housings

- Female cable housings fitted with floating jackscrews (standard gender), hexagonal slotted heads.
- Compatible with all signal, power and coax female cable contacts.
- Housings only - compatible contacts must be purchased separately.
- Mates with any male mixed-technology connectors with the same signal + power/coax layout.
- For other combinations shown on the Technical Drawing, please consult our Experts at [www.harwin.com/contact](http://www.harwin.com/contact).

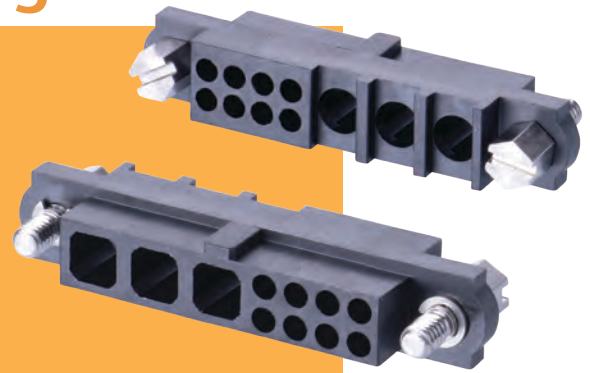

### SIGNAL + POWER/COAX

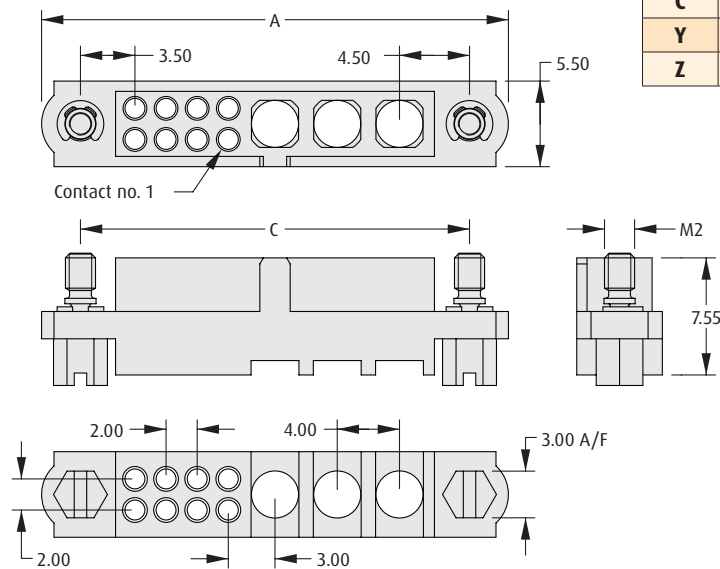

### CALCULATION

<b>A</b>	$(4 \times Y) + Z + 10$
<b>C</b>	$(4 \times Y) + Z + 5$
<b>Y</b>	No. of Power/Coax Contact positions
<b>Z</b>	No. of Signal Contact positions

### HOW TO ORDER

**M80 - 263 F1 XX - XX - 00**

#### SERIES CODE

#### HOUSING

**263** Female

#### CONTACT POSITION COMBINATIONS

<b>02-06</b>	2 power/coax positions, 6 signal positions
<b>02-08</b>	2 power/coax positions, 8 signal positions
<b>03-08</b>	3 power/coax positions, 8 signal positions
<b>04-02</b>	4 power/coax positions, 2 signal positions
<b>04-04</b>	4 power/coax positions, 4 signal positions
<b>04-12</b>	4 power/coax positions, 12 signal positions
<b>06-02</b>	6 power/coax positions, 2 signal positions

#### JACKSCREW

**F1** Floating Hex Slotted, Standard Gender

All dimensions in mm.



# Datamate Mix-Tek Housings

## Female Power/Coax Cable Housings

- Female cable housings fitted with floating jackscrews (standard gender).
- Choice of hexagonal slotted or hex socket for the jackscrew head.
- Compatible with all power and coax female cable contacts.
- Housings only - compatible contacts must be purchased separately.
- Mates with any male connectors with the same power/coax layout.
- For other combinations shown on the Technical Drawing, please consult our Experts at [www.harwin.com/contact](http://www.harwin.com/contact).



DATAMATE MIX-TEK

### HEX SLOTTED JACKSCREW

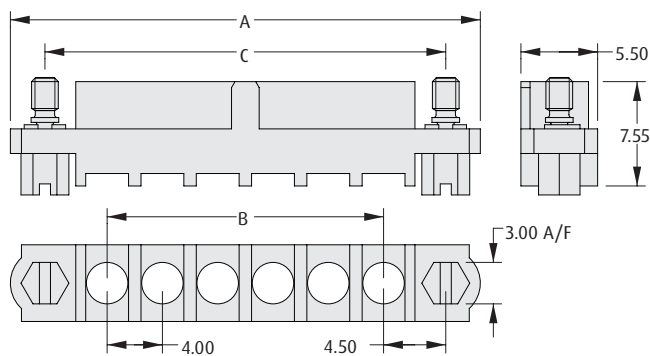

#### CALCULATION

<b>A</b>	B + 14
<b>B</b>	(No. of contact positions - 1) x 4
<b>C</b>	B + 9

### HEX SOCKET JACKSCREW

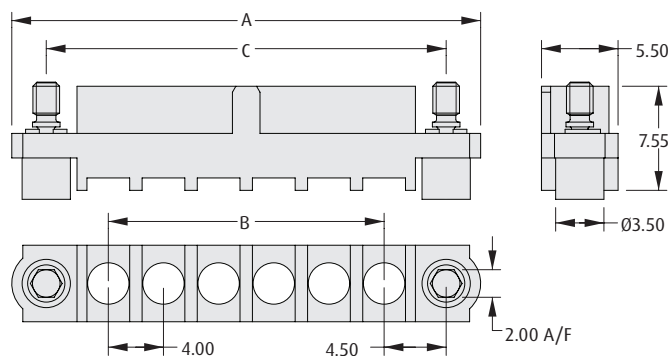

### HOW TO ORDER

**M80 - 263 XX XX - 00 - 00**

SERIES CODE

HOUSING

263 Female

NO. OF POWER/COAX CONTACT POSITIONS

02, 03, 04, 06, 08	All variations
10	F1 jackscrew only

JACKSCREW

F1	Floating Hex Slotted
F2	Floating Hex Socket

All dimensions in mm.

# Datamate Mix-Tek Housings

## Female Power/Coax Cable Housings - Guide Pin, Reverse Fix

- Female cable housings fitted with panel mount jackscrews.
- Guide Pins are compatible with male standard gender jackscrews.
- Reverse fix panel mount is only compatible with male connectors fitted with reverse fix.
- Compatible with all power and coax female cable contacts.
- Housings only - compatible contacts must be purchased separately.
- For other combinations shown on the Technical Drawing, please consult our Experts at [www.harwin.com/contact](http://www.harwin.com/contact).



DATAMATE MIX-TEK

GUIDE PIN WITH PANEL MOUNT		SLOTTED NUT								
	<table border="1"> <thead> <tr> <th colspan="2">CALCULATION</th> </tr> </thead> <tbody> <tr> <td><b>A</b></td> <td><math>B + 14</math></td> </tr> <tr> <td><b>B</b></td> <td><math>(\text{No. of contact positions} - 1) \times 4</math></td> </tr> <tr> <td><b>C</b></td> <td><math>B + 9</math></td> </tr> </tbody> </table>	CALCULATION		<b>A</b>	$B + 14$	<b>B</b>	$(\text{No. of contact positions} - 1) \times 4$	<b>C</b>	$B + 9$	<p>Order separately from connector</p> <p><b>ORDER CODE</b> <b>M80-2130000B</b></p>
CALCULATION										
<b>A</b>	$B + 14$									
<b>B</b>	$(\text{No. of contact positions} - 1) \times 4$									
<b>C</b>	$B + 9$									
<h3>REVERSE FIX WITH PANEL MOUNT</h3>		<h3>HEXAGONAL NUT</h3> <p>Order separately from connector</p> <p><b>ORDER CODE</b> <b>M80-2430000B</b></p>								
<b>HOW TO ORDER</b>										
<p style="text-align: center;"><b>M80 - 263 XX XX - 00 - 00</b></p> <table border="1"> <tr> <td><b>SERIES CODE</b></td> <td>M80</td> <td><b>NO. OF POWER/COAX CONTACT POSITIONS</b></td> <td>02, 03, 04, 06, 08</td> </tr> <tr> <td><b>HOUSING</b></td> <td>263 Female</td> <td><b>JACKSCREW</b></td> <td>F3 Guide pin with 5mm panel mount stud F9 Reverse fix with 5mm panel mount stud</td> </tr> </table>			<b>SERIES CODE</b>	M80	<b>NO. OF POWER/COAX CONTACT POSITIONS</b>	02, 03, 04, 06, 08	<b>HOUSING</b>	263 Female	<b>JACKSCREW</b>	F3 Guide pin with 5mm panel mount stud F9 Reverse fix with 5mm panel mount stud
<b>SERIES CODE</b>	M80	<b>NO. OF POWER/COAX CONTACT POSITIONS</b>	02, 03, 04, 06, 08							
<b>HOUSING</b>	263 Female	<b>JACKSCREW</b>	F3 Guide pin with 5mm panel mount stud F9 Reverse fix with 5mm panel mount stud							

All dimensions in mm.

# Datamate Mix-Tek Housings

## Female Power/Coax Cable Housings - 101Lok

- Female cable housings fitted with secure, fast and simple bayonet fixings, no special tooling required.
- Mates with male connectors fitted with 101Lok receptacles.
- Housings only - compatible contacts must be purchased separately.
- Compatible with all power and coax female cable contacts.
- For other combinations shown on the Technical Drawing, please consult our Experts at [www.harwin.com/contact](http://www.harwin.com/contact).



DATAMATE MIX-TEK

### 101LOK

### CALCULATION

<b>A</b>	B + 14
<b>B</b>	(No. of contact positions - 1) x 4
<b>C</b>	B + 9

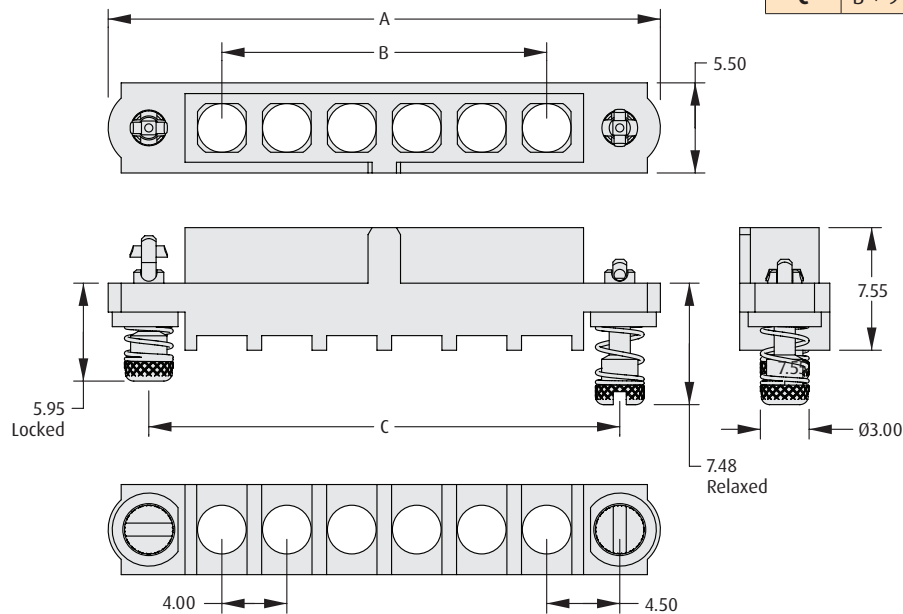

### HOW TO ORDER

**M80 - 263 FC XX - 00 - 00**

SERIES CODE

HOUSING

263 Female

NO. OF POWER/COAX CONTACT POSITIONS

02, 03, 04, 06, 08

JACKSCREW

FC 101Lok fixing

All dimensions in mm.

# Datamate Mix-Tek Housings

## Male Power/Coax Cable Housings

- ❖ Male cable housings fitted with either internally threaded jackscrews (standard gender) or 101Lok receptacles.
- ❖ Internal threaded jackscrews compatible with standard gender floating jackscrews or guide pins.
- ❖ 101Lok receptacle fixings compatible with 101Lok bayonet female fixings.
- ❖ Housings only - compatible power and coax male contacts must be purchased separately.
- ❖ For other combinations shown on the Technical Drawing, please consult our Experts at [www.harwin.com/contact](http://www.harwin.com/contact).



### INTERNAL THREADED JACKSCREW

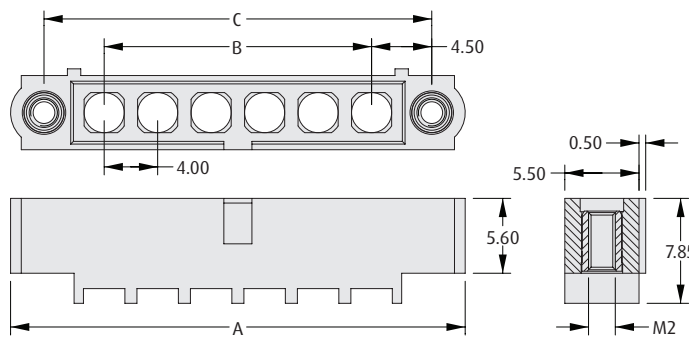

#### CALCULATION

<b>A</b>	B + 14
<b>B</b>	(No. of contact positions - 1) x 4
<b>C</b>	B + 9

### 101LOK RECEPTACLE

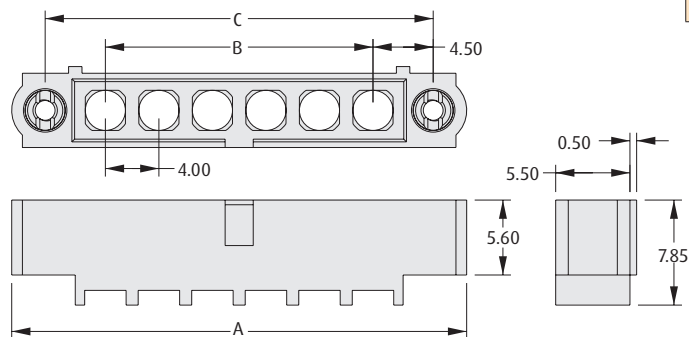

### HOW TO ORDER

**M80 - 273 XX XX - 00 - 00**

SERIES CODE

HOUSING

273 Male

NO. OF POWER/COAX CONTACT POSITIONS

02, 03, 04, 06, 08

JACKSCREW

<b>M1</b>	Internally threaded jackscrew, standard gender
<b>MC</b>	101Lok receptacle fixing

All dimensions in mm.

# Datamate Mix-Tek Housings

## Male Power/Coax Cable Housings - Reverse Fix

- ❖ Male cable housings fitted with floating slotted jackscrews, reverse fix style.
- ❖ Mates with equivalent layout female connectors fitted with reverse fix jackscrews.
- ❖ Housings only - compatible power and coax male contacts must be purchased separately.
- ❖ For other combinations shown on the Technical Drawing, please consult our Experts at [www.harwin.com/contact](http://www.harwin.com/contact).



DATAMATE MIX-TEK

### REVERSE FIX

### CALCULATION

<b>A</b>	B + 14
<b>B</b>	(No. of contact positions - 1) x 4
<b>C</b>	B + 9

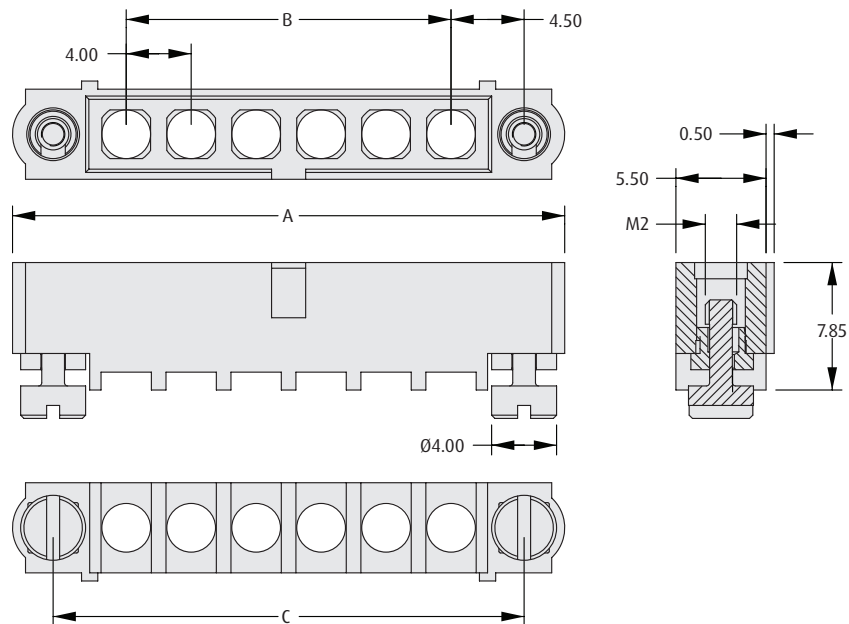

### HOW TO ORDER

**M80 - 273 MA XX - 00 - 00**

SERIES CODE

NO. OF POWER/COAX CONTACT POSITIONS

02, 03, 04, 06, 08

HOUSING

273 Male

JACKSCREW

MA Floating slotted, reverse fix

All dimensions in mm.

# Datamate Mix-Tek Cable Contacts

## Female Signal Contacts

- Compatible with the signal + power/coax housings. See following pages for power and coax contacts.









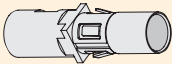

DATAMATE MIX-TEK

CRIMP CONTACTS	DUMMY CONTACT												
<p><b>Large Bore (22 AWG)</b></p> <p><b>Small Bore (24 to 28 AWG)</b></p> <p><b>Extra Small Bore (28 to 32 AWG)</b></p>	<div style="border: 1px solid black; padding: 2px; width: fit-content; margin-top: 5px;"> <b>ORDER CODE</b>  <b>M80-023</b> </div>												
	WIRE STRIPPING DETAILS												
	TOOLS												
	<p><b>Recommended Crimp Tool</b> - M22520/2-01  <b>Positioner</b> - T5747  <b>Contact Insertion/Removal Tool</b> - Z80-280</p> <ul style="list-style-type: none"> <li>Instruction sheets available at <a href="http://www.harwin.com/instructions">www.harwin.com/instructions</a>.</li> </ul>												
HOW TO ORDER													
<p><b>M80 - 0XX 00 XX</b></p>													
<div style="border: 1px solid black; padding: 2px; width: fit-content; margin-bottom: 10px;"> <b>SERIES CODE</b> </div> <table border="1" style="width: 100%; border-collapse: collapse;"> <thead> <tr> <th style="background-color: #f4a460;">TYPE</th> <th></th> </tr> </thead> <tbody> <tr> <td style="text-align: center;"><b>011</b></td> <td>Large Bore (22 AWG)</td> </tr> <tr> <td style="text-align: center;"><b>013</b></td> <td>Small Bore (24-28 AWG)</td> </tr> <tr> <td style="text-align: center;"><b>019</b></td> <td>Extra Small Bore (28-32 AWG)</td> </tr> </tbody> </table>	TYPE		<b>011</b>	Large Bore (22 AWG)	<b>013</b>	Small Bore (24-28 AWG)	<b>019</b>	Extra Small Bore (28-32 AWG)	<div style="border: 1px solid black; padding: 2px; width: fit-content; margin-top: 10px;"> <b>FINISH</b> </div> <table border="1" style="width: 100%; border-collapse: collapse;"> <tbody> <tr> <td style="text-align: center;"><b>01</b></td> <td>Gold + Tin</td> </tr> <tr> <td style="text-align: center;"><b>05</b></td> <td>Gold</td> </tr> </tbody> </table>	<b>01</b>	Gold + Tin	<b>05</b>	Gold
TYPE													
<b>011</b>	Large Bore (22 AWG)												
<b>013</b>	Small Bore (24-28 AWG)												
<b>019</b>	Extra Small Bore (28-32 AWG)												
<b>01</b>	Gold + Tin												
<b>05</b>	Gold												

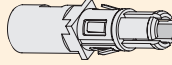

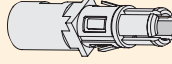
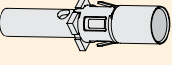
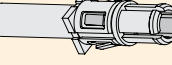
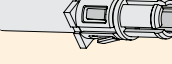
All dimensions in mm.

# Datamate Mix-Tek Cable Contacts

- ❖ Compatible contacts for use with all Mix-Tek cable housings.
- ❖ Female standard power contacts mate with male standard power, female high power with male high power. Standard power contacts do not mate with high power.

STANDARD POWER					
Female	Male	Wire Size	Current Rating	Connection	Wire Strip Length
 M80-325	 M80-335	12 AWG	Up to 20A	Solder	5.00mm min
 M80-326	 M80-336	14 AWG	Up to 15A	Solder	5.00mm min
 M80-327	 M80-337	16 AWG	Up to 10A	Solder	5.00mm min
 M80-328	 M80-338	18 AWG	Up to 8A	Crimp	4.75-5.25mm
 M80-329	 M80-339	20 AWG	Up to 5A	Crimp	4.75-5.25mm
 M80-32A		12 AWG	Up to 20A	Solder	5.00mm min
 M80-32B		14 AWG	Up to 15A	Solder	5.00mm min
 M80-32C		16 AWG	Up to 10A	Solder	5.00mm min

## HIGH POWER

 M80-PF5	 M80-PM5	10 AWG	Up to 40A	Solder	5.00mm min
--	--	--------	-----------	--------	------------

### TOOLS

**Recommended Crimp Tool** - Z80-294  
**Positioner** - Z80-295  
**Contact Removal Tool** - Z80-290

- ❖ Crimp Tool and Positioner required only for the Crimp contacts. No special tool is required for connecting wire to the solder contacts, other than standard soldering equipment.
- ❖ Instruction sheets available at [www.harwin.com/instructions](http://www.harwin.com/instructions).

# Datamate Mix-Tek Cable Contacts

- ❖ Compatible contacts for use with all Mix-Tek cable housings.
- ❖ Straight coax contacts can mate with right-angle coax contacts.

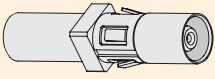
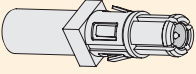
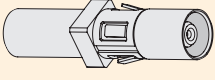
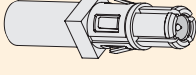
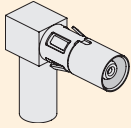
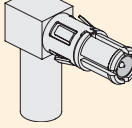
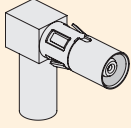
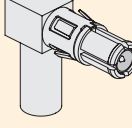
COAX					
Female	Male	Coax Size	Coax Type	Connection	Wire Strip Length
 M80-305	 M80-315	Ø2.00mm	RG178	Crimp	See Figure 1
 M80-307	 M80-317	Ø2.70mm	RG174 RG179 RG316	Crimp	See Figure 1
 M80-308	 M80-318	Ø2.00mm	RG178	Crimp	See Figure 2
 M80-309	 M80-319	Ø2.70mm	RG174 RG179 RG316	Crimp	See Figure 2

## TOOLS

**Recommended Inner Contact Crimp Tool** - Z80-292  
**Positioner for Inner Contact** - Z80-291  
**Recommended Outer Sleeve Crimp Tool** - Z80-293  
**Contact Removal Tool** - Z80-290

❖ Instruction sheets available at [www.harwin.com/instructions](http://www.harwin.com/instructions).

## WIRE STRIPPING DETAILS

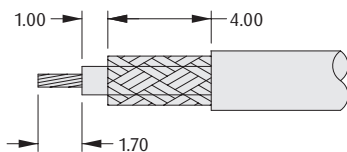

Figure 1

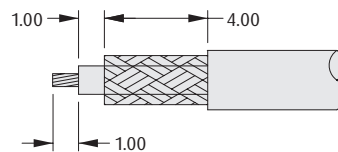

Figure 2

All dimensions in mm.



# Datamate Mix-Tek Connectors

## Metal Backshell Accessories

- ❖ Metal Backshells that can be used with any female cable connector (up to 12AWG), or male connectors with board mount jackscrews.
- ❖ Female backshells come with jackscrews - any existing jackscrews can be removed by removing the e-clip.
- ❖ Suitable for new designs, or in-production addition to enhance existing designs.

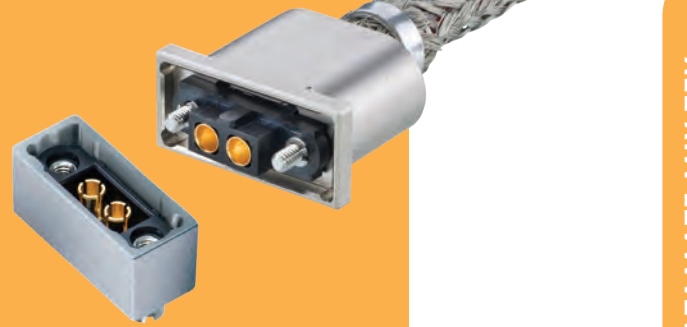

DATAMATE MIX-TEK

## PART NUMBERING SYSTEM

**M80 - 9 XX XX 02**

**SERIES CODE**

**FINISH**

**02** Nickel

**TYPE**

<b>06</b>	Male
<b>45</b>	Female with Slotted Jackscrews
<b>46</b>	Female with Hex Socket Jackscrews

EQUIVALENT NO. OF SIGNAL CONTACTS	NO. OF POWER ONLY OR COAX ONLY CONTACTS	NO. OF CONTACTS IN POWER/SIGNAL COMBINATION
<b>08</b>	2 contacts	-
<b>10</b>	-	2 Power, 2 Signal
<b>12</b>	3 contacts	2 Power, 4 Signal
<b>14</b>	-	2 Power, 6 Signal
<b>16</b>	4 contacts	2 Power, 8 Signal
<b>18</b>	-	4 Power, 2 Signal
<b>20</b>	5 contacts	2 Power, 12 Signal or 4 Power, 4 Signal
<b>22</b>	-	4 Power, 6 Signal
<b>24</b>	6 contacts	4 Power, 8 Signal
<b>28</b>	7 contacts	4 Power, 12 Signal
<b>32</b>	8 contacts	-
<b>36</b>	9 contacts	-
<b>40</b>	10 contacts	-
<b>44</b>	11 contacts	-
<b>48</b>	12 contacts	-

All dimensions in mm.

# Datamate Mix-Tek Connectors

## Female Metal Backshell

- ❖ Supplied as an accessory kit, including metal backshell, e-clips and the applicable jackscrews.
- ❖ To be used with the appropriate size of Female Cable connector kit without jackscrews (existing jackscrews can be removed).
- ❖ Gives 360 degree shielding when used with conductive braid and mated to a compatible male connector with metal backshell.
- ❖ Instruction sheets available at [www.harwin.com/instructions](http://www.harwin.com/instructions).



FEMALE		CALCULATION					
		<b>A</b>	$B + 16.2$				
		<b>B</b>	Equivalent no. of contacts - 2				
		<b>C</b>	$B + 7$				
		<b>D</b>	$B + 0.8$				
<p><b>E-CLIP TOOL</b></p> <p>❖ For assembling E-Clips supplied with kit.</p> <p><b>ORDER CODE</b> <b>Z80-300</b></p>		<p><b>BAND-IT TIE</b></p> <p>❖ For fixing braid to rear collar (requires Tie Dex II A30199 Micro Band tool).</p> <p><b>ORDER CODE</b></p> <table border="1"> <tr> <td><b>M80-9470000</b></td> <td>Length = 206.8mm</td> </tr> <tr> <td><b>M80-9480000</b></td> <td>Length = 362.0mm</td> </tr> </table>		<b>M80-9470000</b>	Length = 206.8mm	<b>M80-9480000</b>	Length = 362.0mm
<b>M80-9470000</b>	Length = 206.8mm						
<b>M80-9480000</b>	Length = 362.0mm						
<b>HOW TO ORDER</b>							
<b>M80 - 94 X XX 02</b>							
<p><b>SERIES CODE</b></p>		<p><b>FINISH</b></p> <table border="1"> <tr> <td><b>02</b></td> <td>Nickel</td> </tr> </table>		<b>02</b>	Nickel		
<b>02</b>	Nickel						
<p><b>TYPE</b></p> <table border="1"> <tr> <td><b>5</b></td> <td>With Slotted Jackscrews</td> </tr> <tr> <td><b>6</b></td> <td>With Hex Socket Jackscrews</td> </tr> </table>		<b>5</b>	With Slotted Jackscrews	<b>6</b>	With Hex Socket Jackscrews	<p><b>EQUIVALENT NO. OF SIGNAL CONTACTS</b></p> <p><b>08, 10, 12, 14, 16, 18, 20, 22, 24, 28, 32, 36, 40, 44, 48</b></p>	
<b>5</b>	With Slotted Jackscrews						
<b>6</b>	With Hex Socket Jackscrews						

All dimensions in mm.

# Datamate Mix-Tek Connectors

## Male Metal Backshell

- ❖ Supplied as an accessory, to be used with existing male connectors.
- ❖ Can be fitted to either male vertical PCB connectors with board mount, or male cable connectors with panel mount jackscrews.
- ❖ Gives 360 degree shielding when mounted to a conductive panel and mated to a compatible female connector with metal backshell.



DATAMATE MIX-TEK

MALE		CALCULATION	
<b>A</b>	$B + 13.7$	<b>B</b>	Equivalent no. of contacts - 2
<b>C</b>	$B + 7$	<b>D</b>	$B + 2.8$

### HOW TO ORDER

**M80 - 906 XX 02**

<b>SERIES CODE</b>	<b>FINISH</b>	
	<b>02</b>	Nickel

<b>EQUIVALENT NO. OF SIGNAL CONTACTS</b>	
08, 10, 12, 14, 16, 18, 20, 22, 24, 28, 32, 36, 40, 44, 48	

All dimensions in mm.

# Datamate J-Tek Specification

DATAMATE J-TEK

## Materials

<b>Housings:</b>	Glass-filled thermoplastic UL94V-0
<b>Female contacts</b>	
Standard J-Tek:	Brass shell, with Beryllium Copper inner contact
T-Contact:	Beryllium Copper
<b>Male contacts:</b>	Copper alloy
<b>Finish:</b>	See individual pages

## Electrical

### Current - Standard J-Tek

Individual contacts in isolation:	3.3A max (at 25°C) 2.6A max (at 85°C)
All contacts simultaneously:	3.0A max (at 25°C) 2.2A max (at 85°C)
Flex Circuit Assembly:	1.0A max per track (at 25°C)

### Current - T-Contact

Individual contacts in isolation:	8.5A max (at 25°C) 6.5A max (at 85°C)
All contacts simultaneously:	3.5A max (at 25°C) 2.6A max (at 85°C)

### Working voltage

At sea level 1013 mbar: 800V DC or AC peak

### Voltage proof

At sea level 1013 mbar: 1,200V DC or AC peak

### Contact resistance

Initial:	20mΩ max
After conditioning:	25mΩ max

### Insulation resistance

Initial:	1,000MΩ min
After conditioning:	100MΩ min

## Mechanical

### Durability

Standard J-Tek:	500 operations
T-Contact:	1,000 operations

### Insertion force (max)

Standard J-Tek:	2.8N
T-Contact:	4.0N

### Withdrawal force (min)

Standard J-Tek:	0.2N
T-Contact:	0.5N

### Signal crimp accommodation:

22 AWG to 32 AWG  
BS 3G 210 Type A, MIL-W-16878

## Environmental

**Environmental classification:** 55/125/56 days at 95% RH

**Operational temperature:** -55°C to +125°C

### \*Vibration sensitivity

Standard J-Tek:	10Hz to 2000Hz, 0.75mm, 98m/s <sup>2</sup> (10G), duration 6 hours
T-Contact:	10Hz to 2000Hz, 0.75mm, 390m/s <sup>2</sup> (40G), duration 6 hours

### \*Bump severity:

390m/s<sup>2</sup> (40G), 4000 ±10 bumps

### \*Shock severity:

981m/s<sup>2</sup> (100G) for 6ms

### \*Acceleration severity:

490m/s<sup>2</sup> (50G)

\* Tested with connectors with Jackscrews.

# Pin Numbering

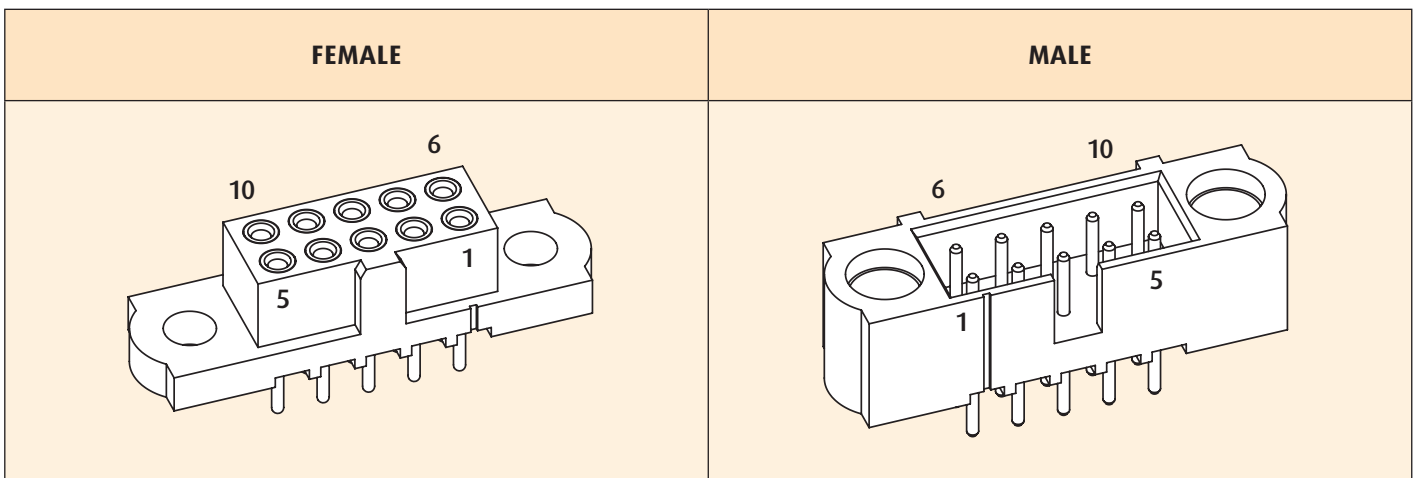

All dimensions in mm.

# Datamate J-Tek Mating Profiles

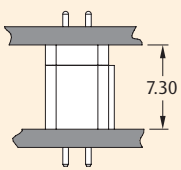
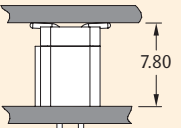
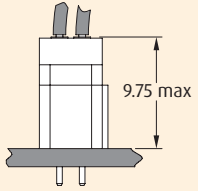
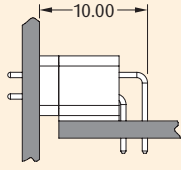
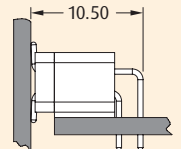
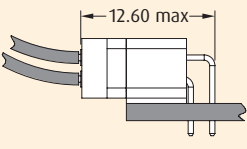
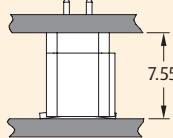
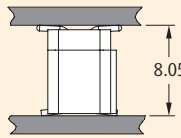
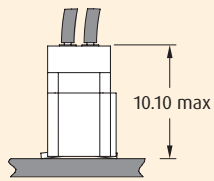
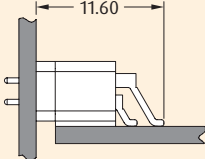
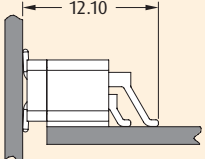
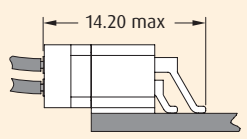
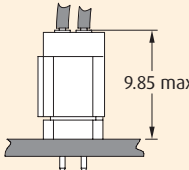
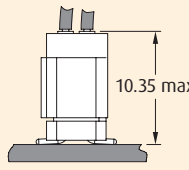
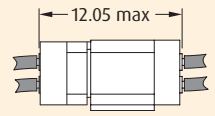
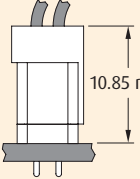
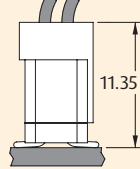
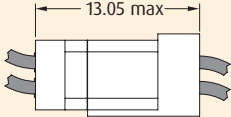
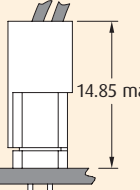
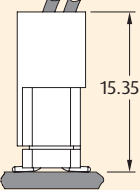
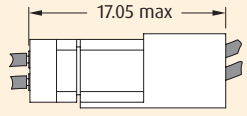
		FEMALE		
		VERTICAL THROUGHBOARD	VERTICAL SMT	CRIMP
<b>MALE</b>	<b>VERTICAL THROUGHBOARD</b>			
	<b>HORIZONTAL THROUGHBOARD</b>			
	<b>VERTICAL SMT</b>			
	<b>HORIZONTAL SMT</b>			
	<b>CRIMP</b>			
	<b>CRIMP 1mm EXTENDED WALL</b>			
	<b>CRIMP 5mm EXTENDED WALL</b>			

All dimensions in mm.

# Datamate J-Tek Mating Profiles

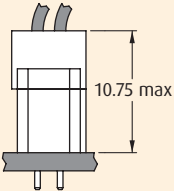
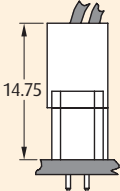
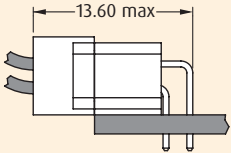
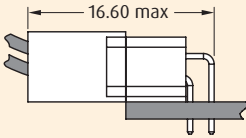
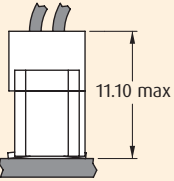
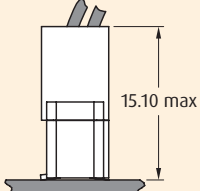
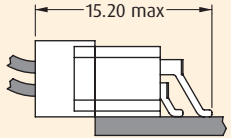
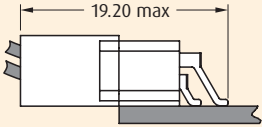
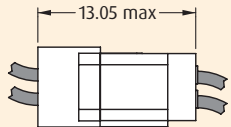
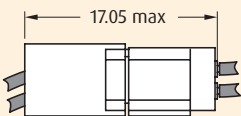
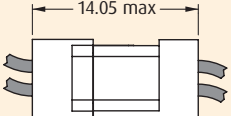
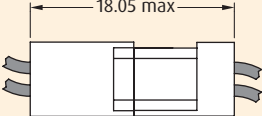
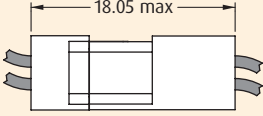
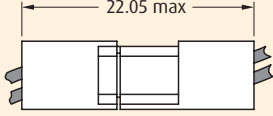
		FEMALE	
		CRIMP 1mm EXTENDED WALL	CRIMP 5mm EXTENDED WALL
<b>MALE</b>	<b>VERTICAL THROUGH-BOARD</b>		
	<b>HORIZONTAL THROUGH-BOARD</b>		
	<b>VERTICAL SMT</b>		
	<b>HORIZONTAL SMT</b>		
	<b>CRIMP</b>		
	<b>CRIMP 1mm EXTENDED WALL</b>		
	<b>CRIMP 5mm EXTENDED WALL</b>		

All dimensions in mm.

# Datamate J-Tek Connectors

## Female Vertical Throughboard

- ❖ Fully shrouded contacts.
- ❖ Polarized housings.
- ❖ Mates with all Datamate J-Tek male connectors with compatible jackscrews.

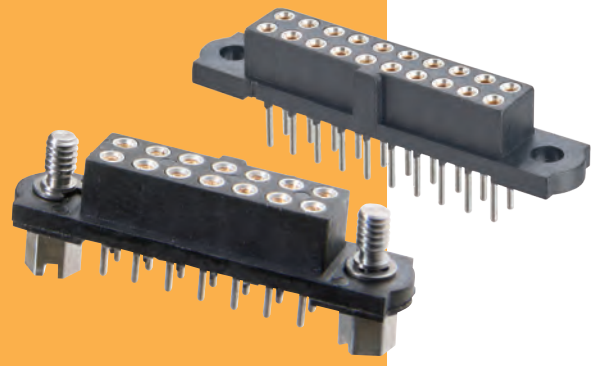

DATAMATE J-TEK

### WITHOUT JACKSCREWS

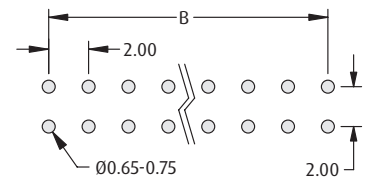
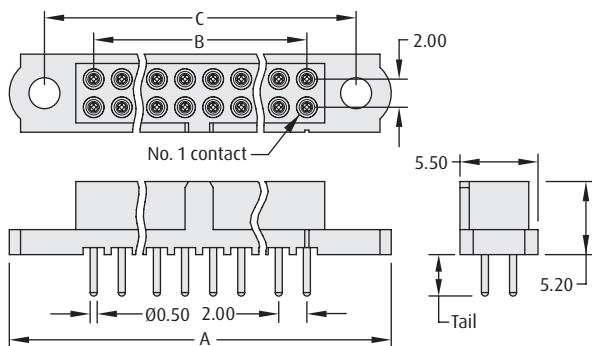

Recommended PC Board Pattern

#### CALCULATION

<b>A</b>	B + 12
<b>B</b>	Total no. of contacts - 2
<b>C</b>	B + 7

### WITH JACKSCREWS

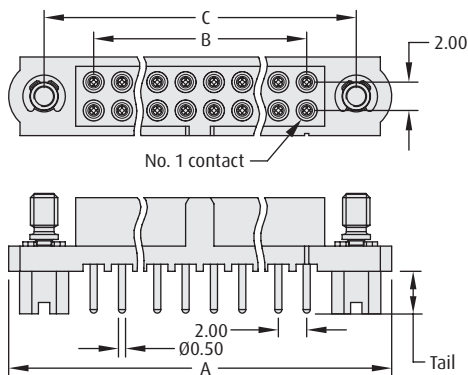

#### Hex Slotted Jackscrew

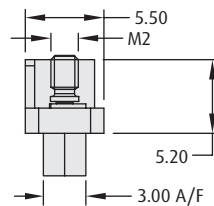

#### Hex Socket Jackscrew

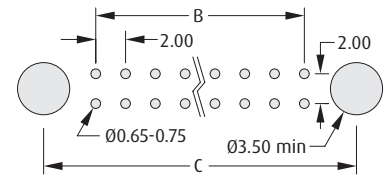
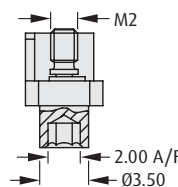

Recommended PC Board Pattern

### HOW TO ORDER

**M80 - 4 X X XX XX**

#### SERIES CODE

<b>0</b>	With Hex Slotted Jackscrews
<b>1</b>	Without Jackscrews
<b>2</b>	With Hex Socket Jackscrews

<b>0</b>	3mm Tails
<b>1</b>	4.5mm Tails

#### FINISH

<b>05</b>	Gold
<b>42</b>	Gold + Tin

#### TOTAL NO. OF CONTACTS

**04, 06, 08, 10, 12, 14, 20, 26, 34, 42, 50**

All dimensions in mm.

# Datamate J-Tek Connectors

DATAMATE J-TEK

## Female Vertical Throughboard, Guide Pin, 101Lok

- Guide pin style includes board mount fixing, and mates with Datamate J-Tek male connectors with compatible jackscrews.
- 101Lok fixing gives secure, fast and simple mating; no special tooling required. Just a simple 101-degree turn is required to fix the connectors together.
- 101Lok style mates with Datamate J-Tek male connectors with compatible 101Lok fixings.



### GUIDE PIN JACKSCREWS

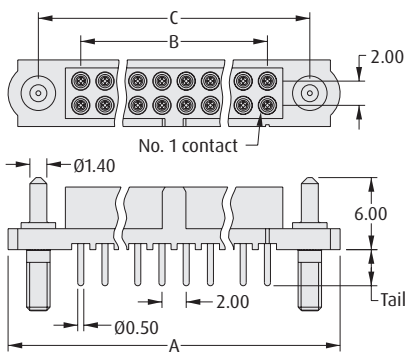

#### Board Mount Nut, 2 per connector

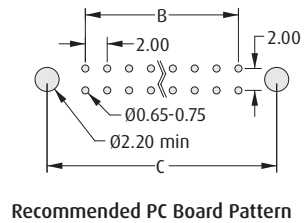
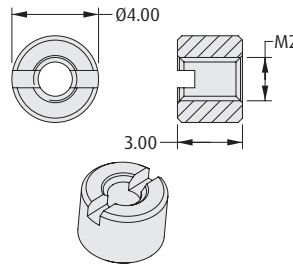

Recommended PC Board Pattern

#### CALCULATION

<b>A</b>	B + 12
<b>B</b>	Total no. of contacts - 2
<b>C</b>	B + 7

### 101LOK

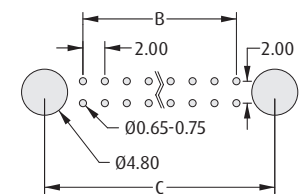
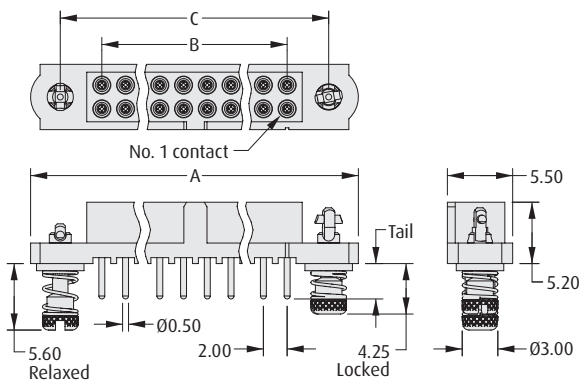

Recommended PC Board Pattern

### HOW TO ORDER

**M80 - 4 TX XX XX FX**

#### SERIES CODE

#### TYPE

<b>T1</b>	3mm Tails
<b>T2</b>	4.5mm Tails

#### TOTAL NO. OF CONTACTS

**04, 06, 08, 10, 12, 14, 20, 26, 34, 42, 50**

#### JACKSCREW

<b>F3</b>	Guide Pin
<b>FD</b>	101Lok

#### FINISH

<b>05</b>	Gold
<b>42</b>	Gold + Tin

All dimensions in mm.



# Datamate J-Tek Connectors

## Female Vertical Throughboard Reverse Fix

- ❖ Fully shrouded contacts.
- ❖ Polarized housings.
- ❖ Includes board mount fixing.
- ❖ Mates with male Datamate J-Tek connectors with compatible Reverse Fix jackscrews.



DATAMATE J-TEK

### REVERSE FIX

### CALCULATION

<b>A</b>	$B + 12$
<b>B</b>	Total no. of contacts - 2
<b>C</b>	$B + 7$

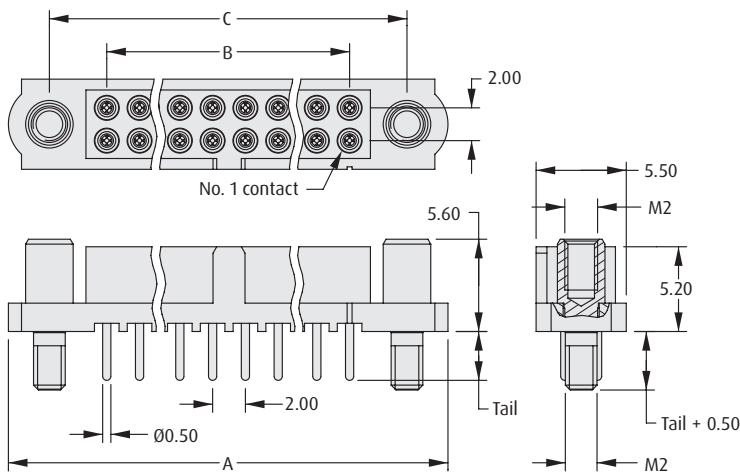

### Board Mount Nut, 2 per connector

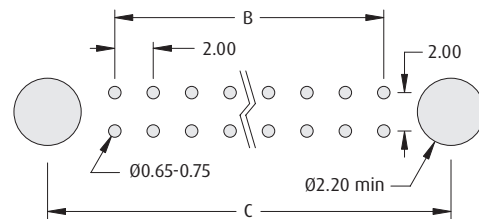
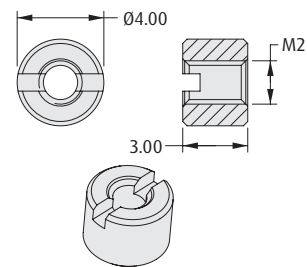

Recommended PC Board Pattern

### HOW TO ORDER

**M80 - 40 X XX XX**

#### SERIES CODE

#### TYPE

<b>5</b>	3mm Tails
<b>6</b>	4.5mm Tails

#### FINISH

<b>05</b>	Gold
<b>42</b>	Gold + Tin

#### TOTAL NO. OF CONTACTS

04, 06, 08, 10, 12, 14, 20, 26, 34, 42, 50

All dimensions in mm.

# Datamate J-Tek Connectors

## Female Vertical Surface Mount

- Mates with all Datamate J-Tek male connectors with compatible jackscrews.
- Gull wing SMT tails simplify inspection process.

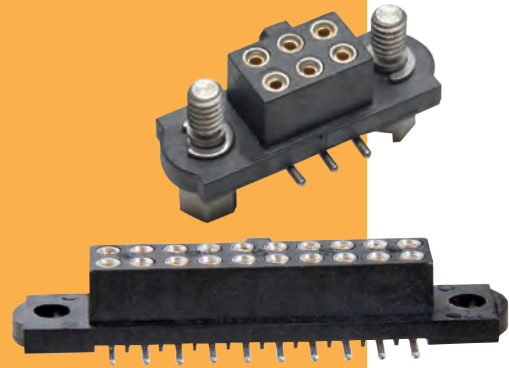

### WITHOUT JACKSCREWS

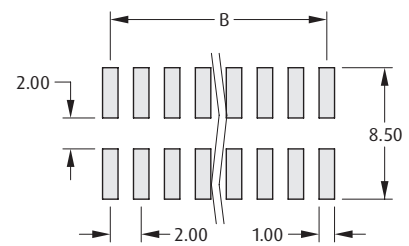
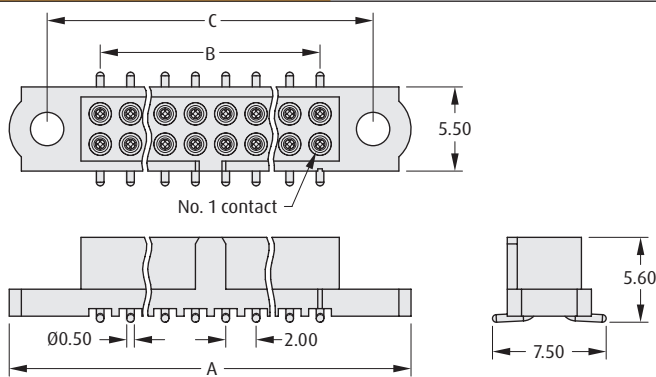

Recommended PC Board Pattern

### CALCULATION

<b>A</b>	$B + 12$
<b>B</b>	Total no. of contacts - 2
<b>C</b>	$B + 7$

### WITH JACKSCREWS

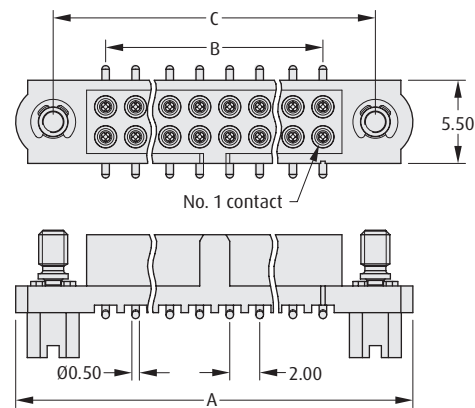

#### Hex Slotted Jackscrew

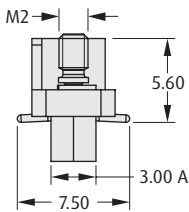

#### Hex Socket Jackscrew

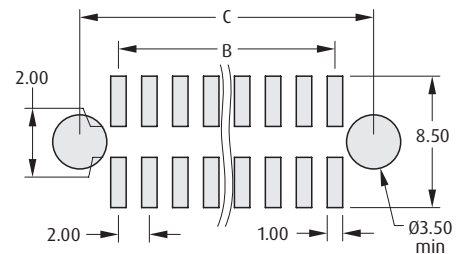
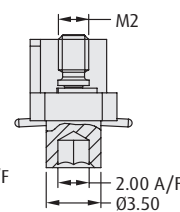

Recommended PC Board Pattern

### HOW TO ORDER

**M80 - 4 X 2 XX XX**

#### SERIES CODE

#### TYPE

<b>0</b>	With Hex Slotted Jackscrews
<b>1</b>	Without Jackscrews
<b>2</b>	With Hex Socket Jackscrews

#### FINISH

<b>05</b>	Gold
<b>42</b>	Gold + Tin

#### TOTAL NO. OF CONTACTS

**04, 06, 08, 10, 12, 14, 20, 26, 34, 42, 50**

All dimensions in mm.

# Datamate J-Tek Connectors

## Female Vertical Surface Mount Guide Pin, 101Lok

- Guide pin style includes board mount fixing, and mates with Datamate J-Tek male connectors with compatible jackscrews.
- 101Lok fixing gives secure, fast and simple mating; no special tooling required. Just a simple 101-degree turn is required to fix the connectors together.
- 101Lok style mates with Datamate J-Tek male connectors with compatible 101Lok fixings.

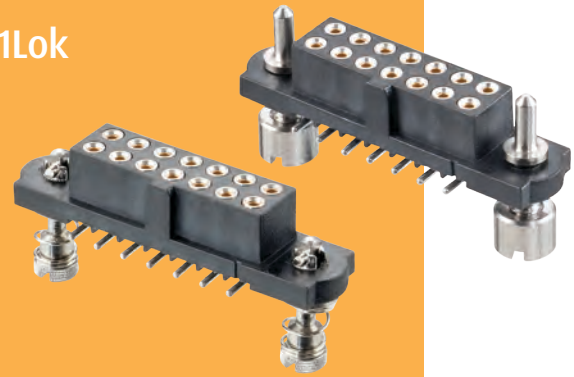

DATAMATE J-TEK

### GUIDE PIN JACKSCREWS

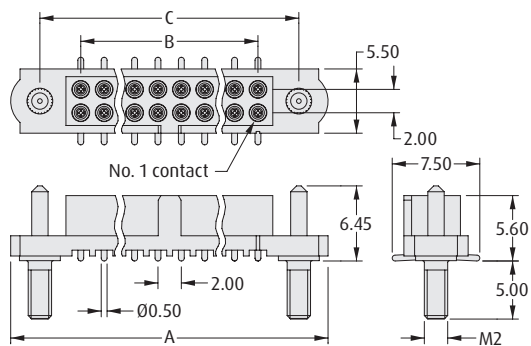

#### Board Mount Nut, 2 per connector

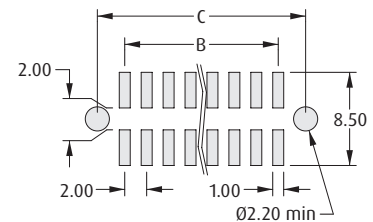
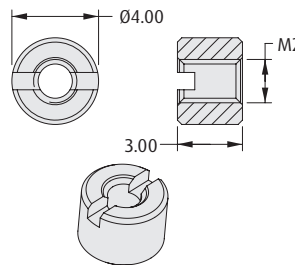

Recommended PC Board Pattern

#### CALCULATION

<b>A</b>	$B + 12$
<b>B</b>	Total no. of contacts - 2
<b>C</b>	$B + 7$

### 101LOK

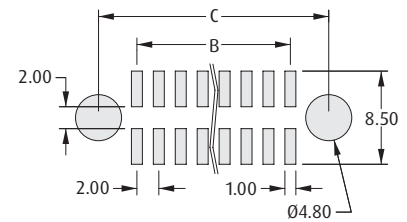
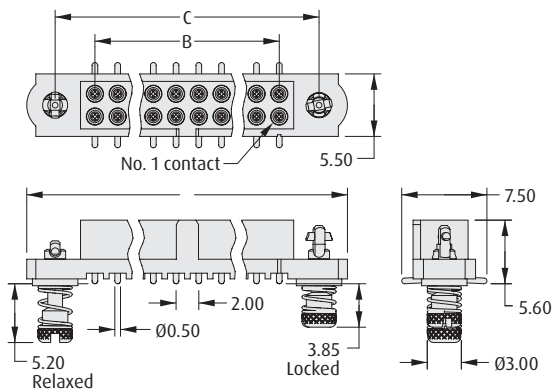

Recommended PC Board Pattern

### HOW TO ORDER

**M80 - 4S1 XX XX FX**

SERIES CODE

TOTAL NO. OF CONTACTS

04, 06, 08, 10, 12, 14, 20, 26, 34, 42, 50

#### JACKSCREW

<b>F3</b>	Guide Pin
<b>FD</b>	101Lok

#### FINISH

<b>05</b>	Gold
<b>42</b>	Gold + Tin

All dimensions in mm.

# Datamate J-Tek Connectors

## Female Vertical Surface Mount Reverse Fix

- Fully shrouded contacts.
- Polarized housings.
- Includes Board Mount fixing.
- Mates with male Datamate J-Tek connectors with compatible Reverse Fix jackscrews.
- Washers are supplied loose, and are to be fitted between the PCB and the housing, around the board mount studs.

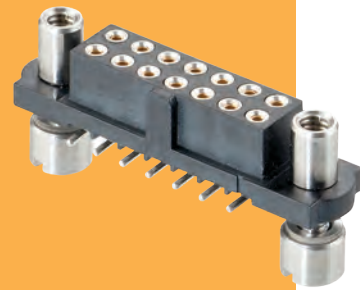

DATAMATE J-TEK

### REVERSE FIX

### CALCULATION

<b>A</b>	B + 12
<b>B</b>	Total no. of contacts - 2
<b>C</b>	B + 7

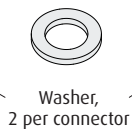
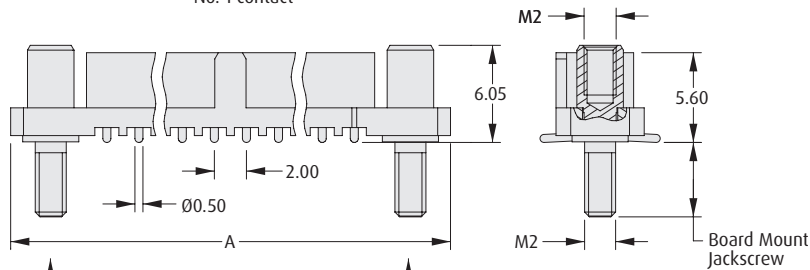
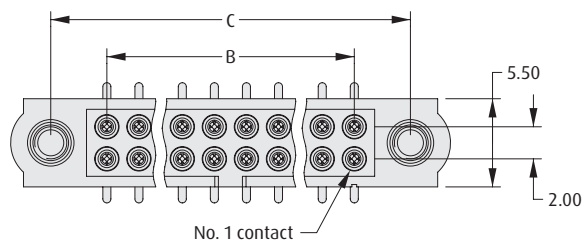

### Board Mount Nut, 2 per connector

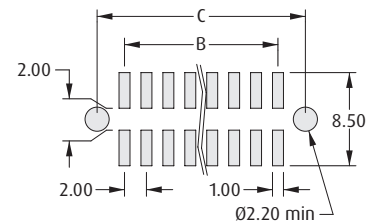
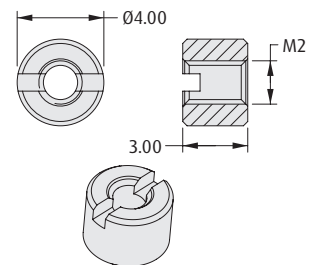

Recommended PC Board Pattern

### HOW TO ORDER

**M80 - 4S1 XX XX FX**

**SERIES CODE**

**TOTAL NO. OF CONTACTS**

04, 06, 08, 10, 12, 14, 20, 26, 34, 42, 50

#### TYPE

<b>F8</b>	3.5mm Board Mount Jackscrew
<b>F9</b>	5mm Board Mount Jackscrew

#### FINISH

<b>05</b>	Gold
<b>42</b>	Gold + Tin

All dimensions in mm.

# Datamate J-Tek Connectors

## Female Crimp Kit

- ❖ Part numbers are for a complete kit of a housing and the applicable number of contacts.
- ❖ Jackscrews are assembled where specified.
- ❖ Crimp contacts are rear insertable.
- ❖ Version also available for 28 – 32 AWG cable – see the following page.
- ❖ Spare contacts are available.

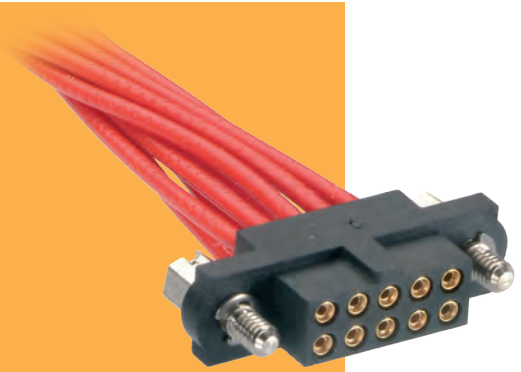

DATAMATE J-TEK

WITHOUT JACKSCREWS		WITH JACKSCREWS																	
		<table border="1"> <thead> <tr> <th colspan="2">CALCULATION</th> </tr> </thead> <tbody> <tr> <td><b>A</b></td> <td>B + 12</td> </tr> <tr> <td><b>B</b></td> <td>Total no. of contacts - 2</td> </tr> <tr> <td><b>C</b></td> <td>B + 7</td> </tr> </tbody> </table>		CALCULATION		<b>A</b>	B + 12	<b>B</b>	Total no. of contacts - 2	<b>C</b>	B + 7								
CALCULATION																			
<b>A</b>	B + 12																		
<b>B</b>	Total no. of contacts - 2																		
<b>C</b>	B + 7																		
<p><b>TOOLS</b></p> <p><b>Recommended Crimp Tool</b> – M22520/2-01  <b>Positioner</b> – T5747  <b>Contact Insertion/Removal Tool</b> – Z80-280</p> <ul style="list-style-type: none"> <li>❖ Spare and pre-cabled contacts shown on following pages.</li> <li>❖ Instruction sheets available at <a href="http://www.harwin.com/instructions">www.harwin.com/instructions</a>.</li> </ul>		<p><b>WIRE STRIPPING DETAILS</b></p>																	
<b>HOW TO ORDER</b>																			
<b>M80 - 4XX XX XX</b>																			
<table border="1"> <thead> <tr> <th colspan="2">SERIES CODE</th> </tr> </thead> <tbody> <tr> <th>LARGE BORE (22 AWG)</th> <th>SMALL BORE (24-28 AWG)</th> </tr> <tr> <td>470</td> <td>471</td> </tr> <tr> <td>460</td> <td>461</td> </tr> <tr> <td>480</td> <td>481</td> </tr> </tbody> </table>		SERIES CODE		LARGE BORE (22 AWG)	SMALL BORE (24-28 AWG)	470	471	460	461	480	481	<table border="1"> <thead> <tr> <th colspan="2">FINISH</th> </tr> </thead> <tbody> <tr> <td>05</td> <td>Gold</td> </tr> <tr> <td>42</td> <td>Gold + Tin</td> </tr> </tbody> </table>		FINISH		05	Gold	42	Gold + Tin
SERIES CODE																			
LARGE BORE (22 AWG)	SMALL BORE (24-28 AWG)																		
470	471																		
460	461																		
480	481																		
FINISH																			
05	Gold																		
42	Gold + Tin																		
<table border="1"> <thead> <tr> <th>LARGE BORE (22 AWG)</th> <th>SMALL BORE (24-28 AWG)</th> <th></th> </tr> </thead> <tbody> <tr> <td>470</td> <td>471</td> <td>Without Jackscrews</td> </tr> <tr> <td>460</td> <td>461</td> <td>With Hex Slotted Jackscrews</td> </tr> <tr> <td>480</td> <td>481</td> <td>With Hex Socket Jackscrews</td> </tr> </tbody> </table>		LARGE BORE (22 AWG)	SMALL BORE (24-28 AWG)		470	471	Without Jackscrews	460	461	With Hex Slotted Jackscrews	480	481	With Hex Socket Jackscrews	<table border="1"> <thead> <tr> <th>TOTAL NO. OF CONTACTS</th> </tr> </thead> <tbody> <tr> <td>04, 06, 08, 10, 12, 14, 20, 26, 34, 42, 50</td> </tr> </tbody> </table>		TOTAL NO. OF CONTACTS	04, 06, 08, 10, 12, 14, 20, 26, 34, 42, 50		
LARGE BORE (22 AWG)	SMALL BORE (24-28 AWG)																		
470	471	Without Jackscrews																	
460	461	With Hex Slotted Jackscrews																	
480	481	With Hex Socket Jackscrews																	
TOTAL NO. OF CONTACTS																			
04, 06, 08, 10, 12, 14, 20, 26, 34, 42, 50																			

All dimensions in mm.

# Datamate J-Tek Connectors

## Female Crimp Kit - Extra Small Bore

- Part numbers are for a complete kit of a housing and the applicable number of contacts.
- Jackscrews are assembled where specified.
- Crimp contacts are rear insertable.
- Versions also available for 22 - 28 AWG cable - see the previous page.
- Spare contacts are available.

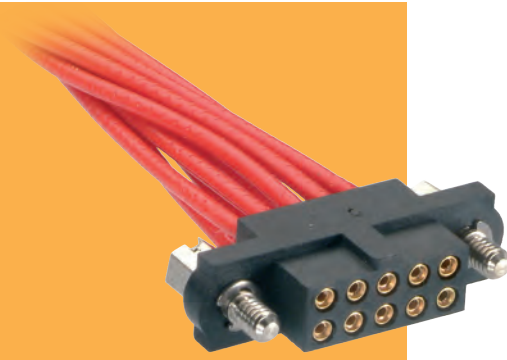

DATAMATE J-TEK

WITHOUT JACKSCREWS	WITH JACKSCREWS												
<table border="1" style="background-color: #f4a460; width: 100%;"> <thead> <tr> <th colspan="2">CALCULATION</th> </tr> </thead> <tbody> <tr> <td><b>A</b></td> <td><math>B + 12</math></td> </tr> <tr> <td><b>B</b></td> <td>Total no. of contacts - 2</td> </tr> <tr> <td><b>C</b></td> <td><math>B + 7</math></td> </tr> </tbody> </table>		CALCULATION		<b>A</b>	$B + 12$	<b>B</b>	Total no. of contacts - 2	<b>C</b>	$B + 7$				
CALCULATION													
<b>A</b>	$B + 12$												
<b>B</b>	Total no. of contacts - 2												
<b>C</b>	$B + 7$												
<b>TOOLS</b>	<b>WIRE STRIPPING DETAILS</b>												
<p><b>Recommended Crimp Tool</b> - M22520/2-01</p> <p><b>Positioner</b> - T5747</p> <p><b>Contact Insertion/Removal Tool</b> - Z80-280</p> <ul style="list-style-type: none"> <li>Spare and pre-cabled contacts shown on following pages.</li> <li>Instruction sheets available at <a href="http://www.harwin.com/instructions">www.harwin.com/instructions</a>.</li> </ul>													
<b>HOW TO ORDER</b>													
<b>M80 - 4 E1 XX XX FX</b>													
<table border="1" style="background-color: #f4a460;"> <tr> <th colspan="2">SERIES CODE</th> </tr> <tr> <td><b>E1</b></td> <td>Extra Small Bore 28-32 AWG</td> </tr> </table>	SERIES CODE		<b>E1</b>	Extra Small Bore 28-32 AWG	<table border="1" style="background-color: #f4a460;"> <tr> <th colspan="2">JACKSCREW</th> </tr> <tr> <td><b>00</b></td> <td>Without Jackscrews</td> </tr> <tr> <td><b>F1</b></td> <td>With Hex Slotted Jackscrews</td> </tr> <tr> <td><b>F2</b></td> <td>With Hex Socket Jackscrews</td> </tr> </table>	JACKSCREW		<b>00</b>	Without Jackscrews	<b>F1</b>	With Hex Slotted Jackscrews	<b>F2</b>	With Hex Socket Jackscrews
SERIES CODE													
<b>E1</b>	Extra Small Bore 28-32 AWG												
JACKSCREW													
<b>00</b>	Without Jackscrews												
<b>F1</b>	With Hex Slotted Jackscrews												
<b>F2</b>	With Hex Socket Jackscrews												
<table border="1" style="background-color: #f4a460;"> <tr> <th colspan="2">TOTAL NO. OF CONTACTS</th> </tr> <tr> <td><b>04, 06, 08, 10, 12, 14, 20, 26, 34, 42, 50</b></td> <td></td> </tr> </table>	TOTAL NO. OF CONTACTS		<b>04, 06, 08, 10, 12, 14, 20, 26, 34, 42, 50</b>		<table border="1" style="background-color: #f4a460;"> <tr> <th colspan="2">FINISH</th> </tr> <tr> <td><b>05</b></td> <td>Gold</td> </tr> <tr> <td><b>42</b></td> <td>Gold + Tin</td> </tr> </table>	FINISH		<b>05</b>	Gold	<b>42</b>	Gold + Tin		
TOTAL NO. OF CONTACTS													
<b>04, 06, 08, 10, 12, 14, 20, 26, 34, 42, 50</b>													
FINISH													
<b>05</b>	Gold												
<b>42</b>	Gold + Tin												

All dimensions in mm.

# Datamate J-Tek Connectors

## Female Crimp Kit - Guide Pin, 101Lok

- Guide pin style includes board mount fixing.
- 101Lok fixing gives secure, fast and simple mating; no special tooling required. Just a simple 101-degree turn is required to fix the connectors together.
- Connectors mate with Datamate J-Tek male connectors with applicable jackscrews or 101Lok fixings.
- Part numbers are for a complete kit of a housing and the applicable number of contacts.



DATAMATE J-TEK

GUIDE PIN JACKSCREWS	101LOK																								
<p><b>Board Mount Nut, 2 per connector</b></p> <table border="1" data-bbox="657 1075 966 1234"> <thead> <tr> <th colspan="2">CALCULATION</th> </tr> </thead> <tbody> <tr> <td><b>A</b></td> <td>B + 12</td> </tr> <tr> <td><b>B</b></td> <td>Total no. of contacts - 2</td> </tr> <tr> <td><b>C</b></td> <td>B + 7</td> </tr> </tbody> </table>	CALCULATION		<b>A</b>	B + 12	<b>B</b>	Total no. of contacts - 2	<b>C</b>	B + 7																	
CALCULATION																									
<b>A</b>	B + 12																								
<b>B</b>	Total no. of contacts - 2																								
<b>C</b>	B + 7																								
<p><b>TOOLS</b></p> <p><b>Recommended Crimp Tool</b> - M22520/2-01  <b>Positioner</b> - T5747  <b>Contact Insertion/Removal Tool</b> - Z80-280</p> <ul style="list-style-type: none"> <li>Spare and pre-cabled contacts shown on following pages.</li> <li>Instruction sheets available at <a href="http://www.harwin.com/instructions">www.harwin.com/instructions</a>.</li> </ul>	<p><b>WIRE STRIPPING DETAILS</b></p>																								
<b>HOW TO ORDER</b>																									
<p style="text-align: center;"><b>M80 - 4 X1 XX XX FX</b></p> <table border="1" data-bbox="146 1669 308 1701"> <tr> <td><b>SERIES CODE</b></td> <td></td> </tr> </table> <table border="1" data-bbox="146 1738 516 1894"> <thead> <tr> <th colspan="2">TYPE</th> </tr> </thead> <tbody> <tr> <td><b>C1</b></td> <td>Small Bore (24-28 AWG)</td> </tr> <tr> <td><b>D1</b></td> <td>Large Bore (22 AWG)</td> </tr> <tr> <td><b>E1</b></td> <td>Extra Small Bore (28-32 AWG)</td> </tr> </tbody> </table> <table border="1" data-bbox="669 1816 1079 1894"> <thead> <tr> <th>TOTAL NO. OF CONTACTS</th> </tr> </thead> <tbody> <tr> <td>04, 06, 08, 10, 12, 14, 20, 26, 34, 42, 50</td> </tr> </tbody> </table> <table border="1" data-bbox="1274 1621 1474 1738"> <thead> <tr> <th colspan="2">JACKSCREW</th> </tr> </thead> <tbody> <tr> <td><b>F3</b></td> <td>Guide Pin</td> </tr> <tr> <td><b>FC</b></td> <td>101Lok</td> </tr> </tbody> </table> <table border="1" data-bbox="1274 1780 1474 1894"> <thead> <tr> <th colspan="2">FINISH</th> </tr> </thead> <tbody> <tr> <td><b>05</b></td> <td>Gold</td> </tr> <tr> <td><b>42</b></td> <td>Gold + Tin</td> </tr> </tbody> </table>		<b>SERIES CODE</b>		TYPE		<b>C1</b>	Small Bore (24-28 AWG)	<b>D1</b>	Large Bore (22 AWG)	<b>E1</b>	Extra Small Bore (28-32 AWG)	TOTAL NO. OF CONTACTS	04, 06, 08, 10, 12, 14, 20, 26, 34, 42, 50	JACKSCREW		<b>F3</b>	Guide Pin	<b>FC</b>	101Lok	FINISH		<b>05</b>	Gold	<b>42</b>	Gold + Tin
<b>SERIES CODE</b>																									
TYPE																									
<b>C1</b>	Small Bore (24-28 AWG)																								
<b>D1</b>	Large Bore (22 AWG)																								
<b>E1</b>	Extra Small Bore (28-32 AWG)																								
TOTAL NO. OF CONTACTS																									
04, 06, 08, 10, 12, 14, 20, 26, 34, 42, 50																									
JACKSCREW																									
<b>F3</b>	Guide Pin																								
<b>FC</b>	101Lok																								
FINISH																									
<b>05</b>	Gold																								
<b>42</b>	Gold + Tin																								

All dimensions in mm.

# Datamate J-Tek Connectors

## Female Crimp Kit - Reverse Fix

- ❖ Allows for further flexibility in system design.
- ❖ Crimp contacts supplied loose and are inserted from rear.
- ❖ Part numbers are for a complete kit of a housing and the applicable number of contacts.
- ❖ Jackscrews are assembled.
- ❖ Mates with male Datamate J-Tek connectors with compatible Reverse Fix jackscrews.

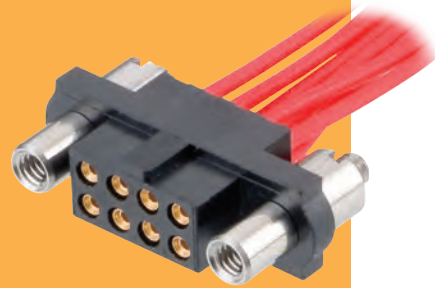

WITH JACKSCREWS	CALCULATION	WIRE STRIPPING DETAILS																											
	<table border="1"> <tr> <td><b>A</b></td> <td><math>B + 12</math></td> </tr> <tr> <td><b>B</b></td> <td>Total no. of contacts - 2</td> </tr> <tr> <td><b>C</b></td> <td><math>B + 7</math></td> </tr> </table>	<b>A</b>	$B + 12$	<b>B</b>	Total no. of contacts - 2	<b>C</b>	$B + 7$																						
	<b>A</b>	$B + 12$																											
	<b>B</b>	Total no. of contacts - 2																											
<b>C</b>	$B + 7$																												
<p><b>Board Mount Nut, 2 per connector</b></p>	<table border="1"> <tr> <td><b>M2</b></td> <td>7.55</td> </tr> <tr> <td><b>M2</b></td> <td></td> </tr> </table> <p>Board Mount Jackscrew</p>	<b>M2</b>	7.55	<b>M2</b>																									
<b>M2</b>	7.55																												
<b>M2</b>																													
<p><b>TOOLS</b></p> <p><b>Recommended Crimp Tool</b> - M22520/2-01  <b>Positioner</b> - T5747  <b>Contact Insertion/Removal Tool</b> - Z80-280</p> <ul style="list-style-type: none"> <li>❖ Spare and pre-cabled contacts shown on following pages.</li> <li>❖ Instruction sheets available at <a href="http://www.harwin.com/instructions">www.harwin.com/instructions</a>.</li> </ul>																													
HOW TO ORDER																													
<p><b>M80 - 4XX XX XX</b></p> <p><b>SERIES CODE</b></p> <table border="1"> <tr> <th colspan="2">TYPE</th> </tr> <tr> <td><b>462</b></td> <td>Large Bore (22 AWG)</td> </tr> <tr> <td><b>463</b></td> <td>Small Bore (24-28 AWG)</td> </tr> </table> <p><b>TOTAL NO. OF CONTACTS</b></p> <p>04, 06, 08, 10, 12, 14, 20, 26, 34, 42, 50</p> <p><b>FINISH</b></p> <table border="1"> <tr> <td><b>05</b></td> <td>Gold</td> </tr> <tr> <td><b>42</b></td> <td>Gold + Tin</td> </tr> </table> <p><b>3.5mm Board Mount Jackscrews only</b></p>		TYPE		<b>462</b>	Large Bore (22 AWG)	<b>463</b>	Small Bore (24-28 AWG)	<b>05</b>	Gold	<b>42</b>	Gold + Tin	<p><b>M80 - 4 X1 XX XX FX</b></p> <p><b>SERIES CODE</b></p> <table border="1"> <tr> <th colspan="2">TYPE</th> </tr> <tr> <td><b>C1</b></td> <td>Small Bore (24-28 AWG)</td> </tr> <tr> <td><b>D1</b></td> <td>Large Bore (22 AWG)</td> </tr> <tr> <td><b>E1</b></td> <td>Extra Small Bore (28-32 AWG)</td> </tr> </table> <p><b>TOTAL NO. OF CONTACTS</b></p> <p>04, 06, 08, 10, 12, 14, 20, 26, 34, 42, 50</p> <p><b>FINISH</b></p> <table border="1"> <tr> <td><b>05</b></td> <td>Gold</td> </tr> <tr> <td><b>42</b></td> <td>Gold + Tin</td> </tr> </table> <p><b>JACKSCREW</b></p> <table border="1"> <tr> <td><b>F8</b></td> <td>3.5mm Board Mount</td> </tr> <tr> <td><b>F9</b></td> <td>5mm Board Mount</td> </tr> </table>		TYPE		<b>C1</b>	Small Bore (24-28 AWG)	<b>D1</b>	Large Bore (22 AWG)	<b>E1</b>	Extra Small Bore (28-32 AWG)	<b>05</b>	Gold	<b>42</b>	Gold + Tin	<b>F8</b>	3.5mm Board Mount	<b>F9</b>	5mm Board Mount
TYPE																													
<b>462</b>	Large Bore (22 AWG)																												
<b>463</b>	Small Bore (24-28 AWG)																												
<b>05</b>	Gold																												
<b>42</b>	Gold + Tin																												
TYPE																													
<b>C1</b>	Small Bore (24-28 AWG)																												
<b>D1</b>	Large Bore (22 AWG)																												
<b>E1</b>	Extra Small Bore (28-32 AWG)																												
<b>05</b>	Gold																												
<b>42</b>	Gold + Tin																												
<b>F8</b>	3.5mm Board Mount																												
<b>F9</b>	5mm Board Mount																												

All dimensions in mm.



# Datamate J-Tek Connectors

## Female Crimp Kit - Extended Wall

- ❖ Extended Wall Datamate allows back potting to be performed.
- ❖ Polarized housings.
- ❖ Crimp contacts are rear insertable.
- ❖ Large bore 22 AWG, small bore 24 - 28 AWG.
- ❖ Part numbers are for a housing and the equivalent number of contacts.



DATAMATE J-TEK

WITHOUT JACKSCREWS	WITH JACKSCREWS																		
<div style="margin-top: 10px;"> <table border="1" style="background-color: #f4a460; color: white;"> <caption>CALCULATION</caption> <tr> <td><b>A</b></td> <td><math>B + 12</math></td> </tr> <tr> <td><b>B</b></td> <td>Total no. of contacts - 2</td> </tr> <tr> <td><b>C</b></td> <td><math>B + 7</math></td> </tr> </table> </div>	<b>A</b>	$B + 12$	<b>B</b>	Total no. of contacts - 2	<b>C</b>	$B + 7$													
<b>A</b>	$B + 12$																		
<b>B</b>	Total no. of contacts - 2																		
<b>C</b>	$B + 7$																		
<b>TOOLS</b>	<b>WIRE STRIPPING DETAILS</b>																		
<p><b>Recommended Crimp Tool</b> - M22520/2-01</p> <p><b>Positioner</b> - T5747</p> <p><b>Contact Insertion/Removal Tool</b> - Z80-280</p> <ul style="list-style-type: none"> <li>❖ Spare and pre-cabled contacts shown on following pages.</li> <li>❖ Instruction sheets available at <a href="http://www.harwin.com/instructions">www.harwin.com/instructions</a>.</li> </ul>																			
HOW TO ORDER																			
<b>M80 - XXX XX XX</b>																			
<b>SERIES CODE</b>	<table border="1" style="background-color: #f4a460;"> <thead> <tr> <th colspan="2">WALL SIZE</th> </tr> </thead> <tbody> <tr> <td><b>BLANK</b></td> <td>Wall = 5mm</td> </tr> <tr> <td><b>A</b></td> <td>Wall = 1mm</td> </tr> </tbody> </table>	WALL SIZE		<b>BLANK</b>	Wall = 5mm	<b>A</b>	Wall = 1mm												
WALL SIZE																			
<b>BLANK</b>	Wall = 5mm																		
<b>A</b>	Wall = 1mm																		
<table border="1" style="background-color: #f4a460;"> <thead> <tr> <th>LARGE BORE (22 AWG)</th> <th>SMALL BORE (24-28 AWG)</th> <th></th> </tr> </thead> <tbody> <tr> <td><b>475</b></td> <td><b>476</b></td> <td>Without Jackscrews</td> </tr> <tr> <td><b>465</b></td> <td><b>466</b></td> <td>With Hex Slotted Jackscrews</td> </tr> <tr> <td><b>485</b></td> <td><b>486</b></td> <td>With Hex Socket Jackscrews</td> </tr> </tbody> </table>	LARGE BORE (22 AWG)	SMALL BORE (24-28 AWG)		<b>475</b>	<b>476</b>	Without Jackscrews	<b>465</b>	<b>466</b>	With Hex Slotted Jackscrews	<b>485</b>	<b>486</b>	With Hex Socket Jackscrews	<table border="1" style="background-color: #f4a460;"> <thead> <tr> <th colspan="2">FINISH</th> </tr> </thead> <tbody> <tr> <td><b>05</b></td> <td>Gold</td> </tr> <tr> <td><b>42</b></td> <td>Gold + Tin</td> </tr> </tbody> </table>	FINISH		<b>05</b>	Gold	<b>42</b>	Gold + Tin
LARGE BORE (22 AWG)	SMALL BORE (24-28 AWG)																		
<b>475</b>	<b>476</b>	Without Jackscrews																	
<b>465</b>	<b>466</b>	With Hex Slotted Jackscrews																	
<b>485</b>	<b>486</b>	With Hex Socket Jackscrews																	
FINISH																			
<b>05</b>	Gold																		
<b>42</b>	Gold + Tin																		
<table border="1" style="background-color: #f4a460;"> <thead> <tr> <th>TOTAL NO. OF CONTACTS</th> </tr> </thead> <tbody> <tr> <td><b>06, 10, 12, 14, 18, 20, 26, 34, 42, 50</b></td> </tr> </tbody> </table>		TOTAL NO. OF CONTACTS	<b>06, 10, 12, 14, 18, 20, 26, 34, 42, 50</b>																
TOTAL NO. OF CONTACTS																			
<b>06, 10, 12, 14, 18, 20, 26, 34, 42, 50</b>																			

All dimensions in mm.

# Datamate J-Tek Connectors

## Female Crimp Kit with Hood

- Supplied as a complete kit: jackscrews assembled to housing; hood, contacts and assembly screws supplied loose.
- Provides strain relief by preventing cable bending at the rear of the connector, and also has the option of inserting a cable tie to reduce pull strain.



DATAMATE J-TEK

FEMALE		CALCULATION							
	<table border="1"> <tr> <td><b>A</b></td> <td><math>B + 21.5</math></td> </tr> <tr> <td><b>B</b></td> <td>Total no. of contacts - 2</td> </tr> <tr> <td><b>C</b></td> <td><math>B + 7</math></td> </tr> </table>		<b>A</b>	$B + 21.5$	<b>B</b>	Total no. of contacts - 2	<b>C</b>	$B + 7$	
	<b>A</b>	$B + 21.5$							
	<b>B</b>	Total no. of contacts - 2							
<b>C</b>	$B + 7$								
TOOLS		WIRE STRIPPING DETAILS							
<p><b>Recommended Crimp Tool</b> - M22520/2-01  <b>Positioner</b> - T5747  <b>Contact Insertion/Removal Tool</b> - Z80-280</p> <ul style="list-style-type: none"> <li>➤ Spare and pre-cabled contacts shown on following pages.</li> <li>➤ Instruction sheets available at <a href="http://www.harwin.com/instructions">www.harwin.com/instructions</a>.</li> </ul>									
HOW TO ORDER									
<p><b>SERIES CODE</b></p> <p><b>M80 - 94 X XX XX</b></p>		<p><b>FINISH</b></p> <table border="1"> <tr> <td><b>05</b></td> <td>Gold</td> </tr> <tr> <td><b>42</b></td> <td>Gold + Tin</td> </tr> </table>		<b>05</b>	Gold	<b>42</b>	Gold + Tin		
<b>05</b>	Gold								
<b>42</b>	Gold + Tin								
<p><b>TYPE</b></p> <table border="1"> <tr> <td><b>0</b></td> <td>Small Bore (24-28 AWG)</td> </tr> <tr> <td><b>1</b></td> <td>Large Bore (22 AWG)</td> </tr> </table>		<b>0</b>	Small Bore (24-28 AWG)	<b>1</b>	Large Bore (22 AWG)	<p><b>TOTAL NO. OF CONTACTS</b></p> <p><b>06, 08, 10, 12, 14, 20, 26, 34, 42, 50</b></p>			
<b>0</b>	Small Bore (24-28 AWG)								
<b>1</b>	Large Bore (22 AWG)								

All dimensions in mm.

# Datamate J-Tek Connectors

## Spare Female Crimp Contacts

❖ Barrel Crimp Contacts are supplied with the connectors - see previous page. Use the order code for extra spare crimps.



DATAMATE J-TEK

CRIMP CONTACTS	DUMMY CONTACT
<p><b>Large Bore (22 AWG)</b></p> <p><b>Small Bore (24 to 28 AWG)</b></p> <p><b>Extra Small Bore (28 to 32 AWG)</b></p>	<div style="border: 1px solid black; padding: 2px; width: fit-content; margin-top: 5px;"> <b>ORDER CODE</b>  <b>M80-023</b> </div>
	WIRE STRIPPING DETAILS
	TOOLS
	<p><b>Recommended Crimp Tool</b> - M22520/2-01  <b>Positioner</b> - T5747  <b>Contact Insertion/Removal Tool</b> - Z80-280</p> <ul style="list-style-type: none"> <li>❖ Pre-cabled contacts shown on following page.</li> <li>❖ Instruction sheets available at <a href="http://www.harwin.com/instructions">www.harwin.com/instructions</a>.</li> </ul>

### HOW TO ORDER

**M80 - 0XX 00 XX**

**SERIES CODE**

TYPE	
<b>011</b>	Large Bore (22 AWG)
<b>013</b>	Small Bore (24-28 AWG)
<b>019</b>	Extra Small Bore (28-32 AWG)

**FINISH**

<b>01</b>	Gold + Tin
<b>05</b>	Gold

All dimensions in mm.

# Datamate J-Tek Connectors

## Female Crimp Contacts – Pre-Crimped Wires

- Female crimp contacts pre-assembled with a choice of BS 3G 210 Type A cable at selected lengths.
- PTFE-insulated, multi-strand silver-plated copper conductor equipment wire.
- Ideal for prototype and pre-production applications.

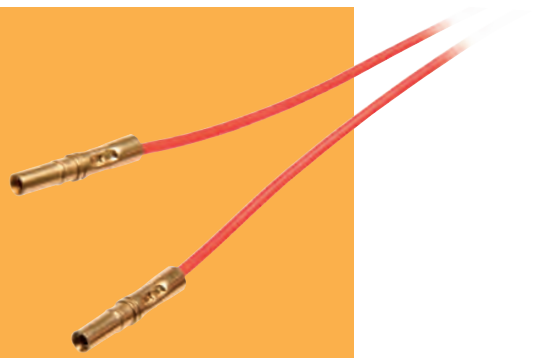

FEMALE SINGLE ENDED	FEMALE - FEMALE

### TOOLS

**Contact Insertion/Removal Tool** – Z80-280

- Full crimp connector kits and spare crimp contacts shown on previous pages.
- Full cable assemblies shown on following page.
- Instruction sheets available at [www.harwin.com/instructions](http://www.harwin.com/instructions).

### HOW TO ORDER

**M80 - 9XX 00 99**

SERIES CODE

CABLE COLOR	
99	Red

SINGLE ENDED	FEMALE-FEMALE	
910	918	22 AWG Cable, 150mm length
911	919	24 AWG Cable, 150mm length
912	920	26 AWG Cable, 150mm length
913	921	28 AWG Cable, 150mm length
914	922	22 AWG Cable, 300mm length
915	923	24 AWG Cable, 300mm length
916	924	26 AWG Cable, 300mm length
917	925	28 AWG Cable, 300mm length

All dimensions in mm.

# Datamate J-Tek Connectors

## Female Cable Assemblies

- Ready-made cable assemblies, fully tested and inspected.
- Extended wall connectors are backpotted for additional strain relief.
- Stainless steel jackscrews to mate with applicable male connector.
- Constructed with Contact 1 to Contact 1, Contact 2 to Contact 2, etc.
- For multicolor sequence, check applicable Technical Drawing.



DATAMATE J-TEK

### PART NUMBERING SYSTEM

**M80 - F X X XX XX FX - XXXX XX**

#### SERIES CODE

#### GENDER - FIRST END

<b>F</b>	Female
----------	--------

#### CONNECTOR STYLE

<b>C</b>	Standard (no extended wall)
<b>E</b>	5mm Extended Wall
<b>F</b>	1mm Extended Wall

#### CABLE SIZE

<b>1</b>	22 AWG
<b>2</b>	24 AWG
<b>3</b>	26 AWG
<b>4</b>	28 AWG
<b>5</b>	30 AWG

#### TOTAL NO. OF CONTACTS

**04 to 50 (even numbers only)**

#### CABLE COLOR

<b>05</b>	White cable (double-ended)
<b>68</b>	Multicolor cable (single-ended)

#### TERMINATION - SECOND END

<b>L</b>	Loose cut end
<b>F0, F1, F2 or FC</b>	Female connector (Same as First End)

#### CABLE LENGTH

<b>0150</b>	150mm
<b>0300</b>	300mm (double-ended)
<b>0450</b>	450mm (single-ended)
<b>XXXX</b>	XXXXmm

#### JACKSCREW

<b>F0</b>	No fixings
<b>F1</b>	Floating Hex Slotted
<b>F2</b>	Floating Hex Socket
<b>FC</b>	101Lok

All dimensions in mm.

# Datamate J-Tek Connectors

- ❖ Examples of available cable assembly options - see previous page for part numbering.
- ❖ Cable assemblies are constructed with Contact 1 to Contact 1, Contact 2 to Contact 2, etc.

## FEMALE SINGLE ENDED

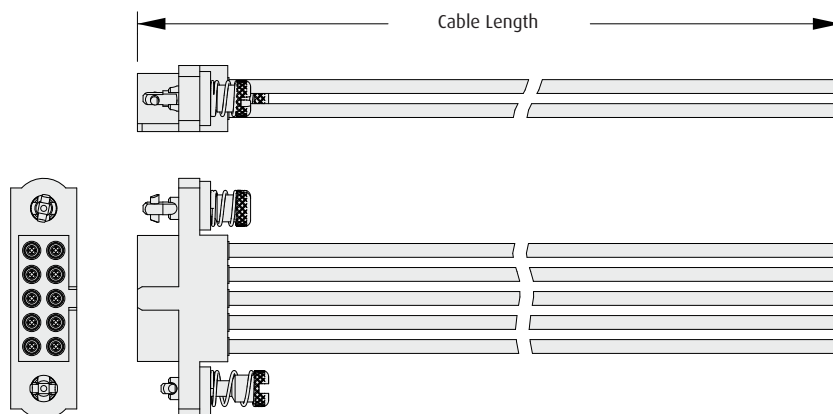

## FEMALE - FEMALE

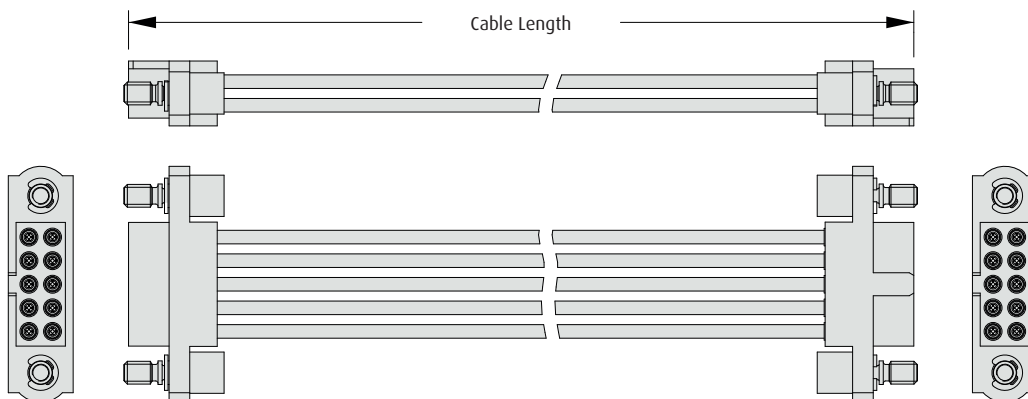

## FEMALE - FEMALE WITH EXTENDED WALLS

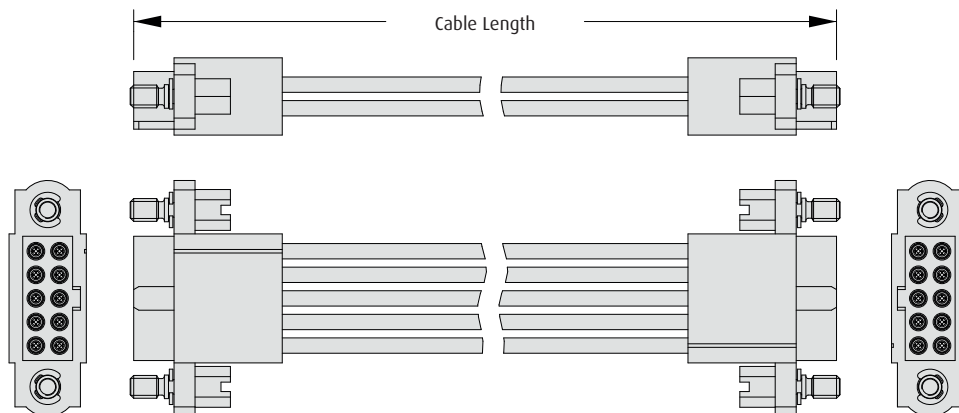

All dimensions in mm.

# Datamate J-Tek Connectors

## Female Crimp T-Contact

- ❖ Advanced single-piece contact design using Beryllium Copper for a 6-finger contact with improved capabilities.
- ❖ Current carrying capacity up to 8.5 Amps per contact.
- ❖ Improved mating durability to 1,000 operations.
- ❖ Suitable for use with 22AWG cable, Ø1.1mm maximum insulation diameter.
- ❖ Compatible cable housings showing on the following pages - order contact and housings separately.



DATAMATE J-TEK

### CRIMP CONTACTS

#### Large Bore (22 AWG)

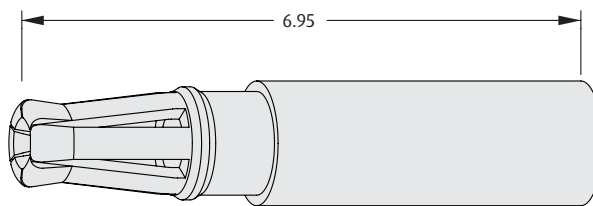

### TOOLS

**Recommended Crimp Tool** - M22520/2-01  
**Positioner** - Z80-444  
**Contact insertion/Removal Tool** - Z80-280  
 ❖ Instruction sheets available at [www.harwin.com/instructions](http://www.harwin.com/instructions).

### WIRE STRIPPING DETAILS

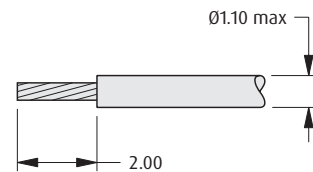

### HOW TO ORDER

**M80 - 206 00 05**

**SERIES CODE**

**FINISH**

**05** Gold

All dimensions in mm.

Patent Pending

# Datamate J-Tek Connectors

## Female Crimp Housing

- Compatible with all female signal barrel crimp contacts, including T-Contact shown on previous page.
- Use insertion tool to insert crimped contacts into rear of connector housing: **order code Z80-280**.
- Connectors mate with Datamate J-Tek male connectors with applicable jackscrews.
- Jackscrews are supplied already assembled to housing.

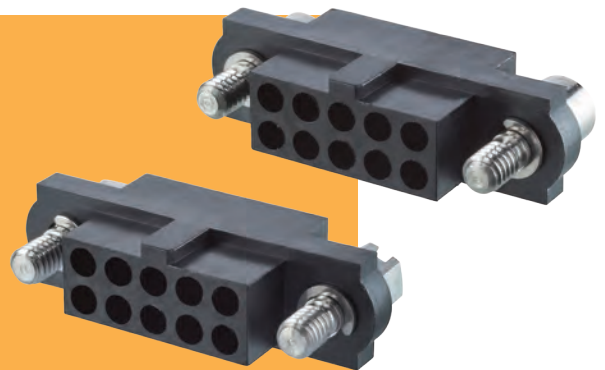

DATAMATE J-TEK

### HEX SLOTTED JACKSCREWS

### HEX SOCKET JACKSCREWS

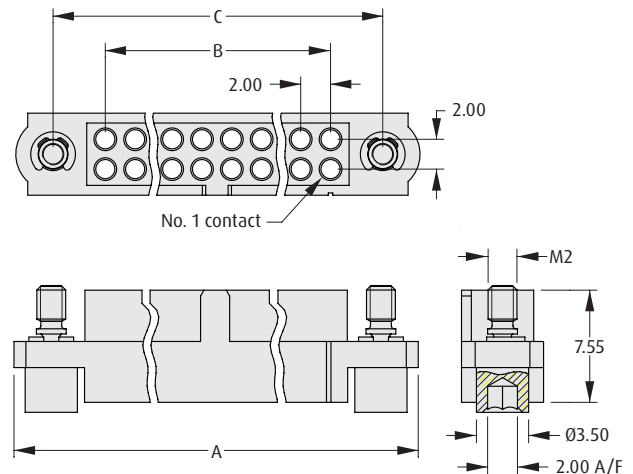
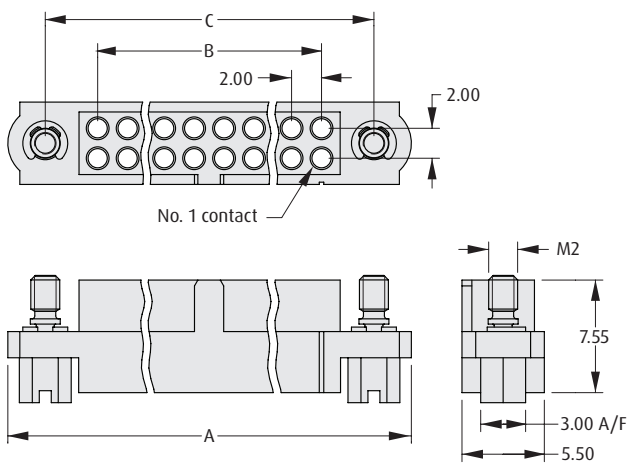

#### CALCULATION

<b>A</b>	$B + 12$
<b>B</b>	Total no. of contacts - 2
<b>C</b>	$B + 7$

### HOW TO ORDER

**M80 - 41 X XX 98**

**SERIES CODE**

**JACKSCREW TYPE**

<b>3</b>	Hex Slotted Jackscrews
<b>4</b>	Hex Socket Jackscrews

**TOTAL NO. OF CONTACTS**

**04 to 50 (Even numbers only)**

All dimensions in mm.



# Datamate J-Tek Connectors

## Female Crimp Housing - Guide Pin, 101Lok

- Compatible with all female signal barrel crimp contacts, including T-Contact shown on previous page.
- Guide pin style includes board mount fixing.
- 101Lok fixing gives secure, fast and simple mating; no special tooling required. Just a simple 101-degree turn is required to fix the connectors together.
- Connectors mate with Datamate J-Tek male connectors with applicable jackscrews or 101Lok fixings.



DATAMATE J-TEK

GUIDE PIN JACKSCREWS	101LOK								
<table border="1" style="width: 100%;"> <thead> <tr> <th colspan="2" style="background-color: #f4a460;">CALCULATION</th> </tr> </thead> <tbody> <tr> <td style="background-color: #f4a460;">A</td> <td>B + 12</td> </tr> <tr> <td style="background-color: #f4a460;">B</td> <td>Total no. of contacts - 2</td> </tr> <tr> <td style="background-color: #f4a460;">C</td> <td>B + 7</td> </tr> </tbody> </table>		CALCULATION		A	B + 12	B	Total no. of contacts - 2	C	B + 7
CALCULATION									
A	B + 12								
B	Total no. of contacts - 2								
C	B + 7								
<b>HOW TO ORDER</b>									
<b>M80 - 41 X XX 98</b>									
<b>SERIES CODE</b>	<b>TOTAL NO. OF CONTACTS</b> 04 to 50 (Even numbers only)								
<table border="1" style="width: 100%;"> <thead> <tr> <th colspan="2" style="background-color: #f4a460;">JACKSCREW TYPE</th> </tr> </thead> <tbody> <tr> <td style="background-color: #f4a460;">7</td> <td>Guide Pin Jackscrews</td> </tr> <tr> <td style="background-color: #f4a460;">8</td> <td>101Lok</td> </tr> </tbody> </table>	JACKSCREW TYPE		7	Guide Pin Jackscrews	8	101Lok			
JACKSCREW TYPE									
7	Guide Pin Jackscrews								
8	101Lok								
<b>HARDWARE FOR GUIDE PIN STUD</b>									
<b>Slotted Board Mount Nut</b>	Order separately from connector								
<b>ORDER CODE</b> M80-2130000B									
<b>Hexagonal Board Mount Nut</b>									
<b>ORDER CODE</b> M80-2430000B									

All dimensions in mm.

# Datamate J-Tek Connectors

## Female Crimp Housing - Reverse Fix

- Compatible with all female signal barrel crimp contacts, including T-Contact shown on previous page.
- Use insertion tool to insert crimped contacts into rear of connector housing: **order code Z80-280**.
- Jackscrows are supplied already assembled to housing.
- Connectors mate with Datamate J-Tek male connectors with compatible Reverse Fix jackscrows.

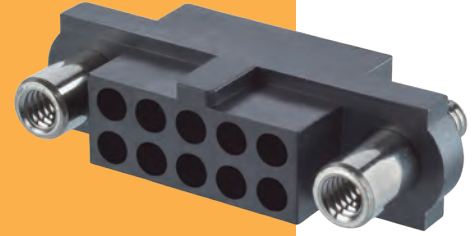

DATAMATE J-TEK

### REVERSE FIX JACKSCREWS

### CALCULATION

<b>A</b>	B + 12
<b>B</b>	Total no. of contacts - 2
<b>C</b>	B + 7

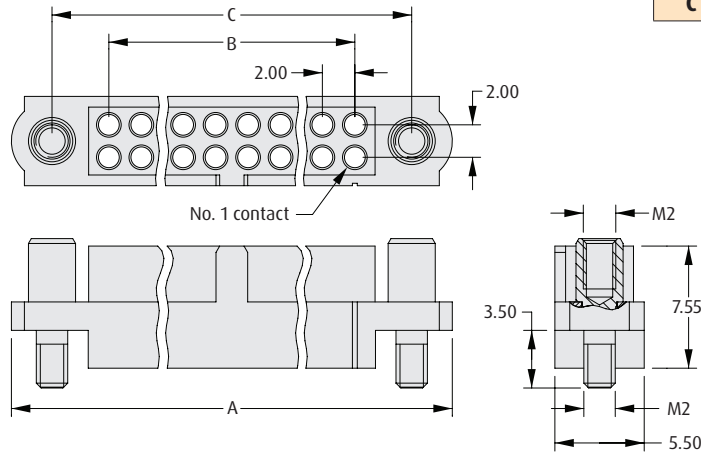

### HOW TO ORDER

**M80 - 41 5 XX 98**

SERIES CODE

JACKSCREW TYPE

5 Reverse Fix Jackscrew

TOTAL NO. OF CONTACTS

04 to 50 (Even numbers only)

### HARDWARE FOR PANEL MOUNT STUD

Order separately from connector

#### Slotted Board Mount Nut

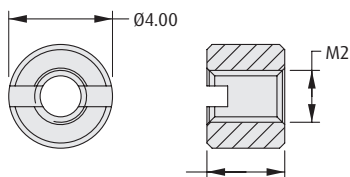

ORDER CODE

M80-2130000B

#### Hexagonal Board Mount Nut

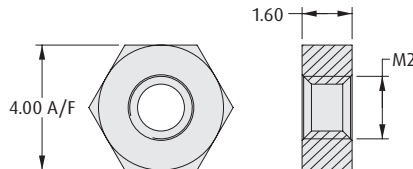

ORDER CODE

M80-2430000B

All dimensions in mm.

# Datamate J-Tek Connectors

## Female Cable Assemblies - T-Contact

- Ready-made cable assemblies, fully tested and inspected.
- 6-finger Beryllium Copper T-Contacts, up to 8.5A per contact.
- Stainless steel jackscrews to mate with applicable male connector.
- Constructed with Contact 1 to Contact 1, Contact A to Contact A, etc.
- For multicolor sequence, check applicable Technical Drawing.



DATAMATE J-TEK

FEMALE SINGLE ENDED	FEMALE - FEMALE										
HOW TO ORDER											
<b>M80 - F B1 XX XX FX - XXXX XX</b>											
<table border="1" style="width: 100%; border-collapse: collapse;"> <tr style="background-color: #f4a460; color: white;"><th>SERIES CODE</th></tr> <tr><td>M80</td></tr> </table>	SERIES CODE	M80	<table border="1" style="width: 100%; border-collapse: collapse;"> <tr style="background-color: #f4a460; color: white;"><th>TERMINATION - SECOND END</th></tr> <tr><td>L</td><td>Loose cut end</td></tr> <tr><td>F1, F2 or FC</td><td>Female connector (same as First End)</td></tr> </table>	TERMINATION - SECOND END	L	Loose cut end	F1, F2 or FC	Female connector (same as First End)			
SERIES CODE											
M80											
TERMINATION - SECOND END											
L	Loose cut end										
F1, F2 or FC	Female connector (same as First End)										
<table border="1" style="width: 100%; border-collapse: collapse;"> <tr style="background-color: #f4a460; color: white;"><th>GENDER - FIRST END</th></tr> <tr><td>F</td><td>Female</td></tr> </table>	GENDER - FIRST END	F	Female	<table border="1" style="width: 100%; border-collapse: collapse;"> <tr style="background-color: #f4a460; color: white;"><th>CABLE LENGTH</th></tr> <tr><td>XXXX</td><td>XXXXmm</td></tr> </table>	CABLE LENGTH	XXXX	XXXXmm				
GENDER - FIRST END											
F	Female										
CABLE LENGTH											
XXXX	XXXXmm										
<table border="1" style="width: 100%; border-collapse: collapse;"> <tr style="background-color: #f4a460; color: white;"><th>CABLE SIZE</th></tr> <tr><td>B1</td><td>22 AWG, T-Contact</td></tr> </table>	CABLE SIZE	B1	22 AWG, T-Contact	<table border="1" style="width: 100%; border-collapse: collapse;"> <tr style="background-color: #f4a460; color: white;"><th>SCREW-LOK</th></tr> <tr><td>F1</td><td>Floating Hex Slotted</td></tr> <tr><td>F2</td><td>Floating Hex Socket</td></tr> <tr><td>FC</td><td>101Lok</td></tr> </table>	SCREW-LOK	F1	Floating Hex Slotted	F2	Floating Hex Socket	FC	101Lok
CABLE SIZE											
B1	22 AWG, T-Contact										
SCREW-LOK											
F1	Floating Hex Slotted										
F2	Floating Hex Socket										
FC	101Lok										
<table border="1" style="width: 100%; border-collapse: collapse;"> <tr style="background-color: #f4a460; color: white;"><th>TOTAL NO. OF CONTACTS</th></tr> <tr><td>04 to 50 (even numbers only)</td></tr> </table>	TOTAL NO. OF CONTACTS	04 to 50 (even numbers only)									
TOTAL NO. OF CONTACTS											
04 to 50 (even numbers only)											
<table border="1" style="width: 100%; border-collapse: collapse;"> <tr style="background-color: #f4a460; color: white;"><th>CABLE COLOR</th></tr> <tr><td>05</td><td>White cable (double-ended)</td></tr> <tr><td>68</td><td>Multicolor cable (single-ended)</td></tr> </table>	CABLE COLOR	05	White cable (double-ended)	68	Multicolor cable (single-ended)						
CABLE COLOR											
05	White cable (double-ended)										
68	Multicolor cable (single-ended)										

All dimensions in mm.

# Datamate J-Tek Connectors

## Female Metal Backshell

- ❖ Supplied as an accessory kit, including metal backshell, e-clips and the applicable jackscrews.
- ❖ To be used with the appropriate size of Female Crimp Kit without jackscrews.
- ❖ Gives 360 degree shielding when used with conductive braid and mated to a compatible male connector with metal backshell.
- ❖ Instruction sheets available at [www.harwin.com/instructions](http://www.harwin.com/instructions).



### FEMALE

### CALCULATION

<b>A</b>	B + 16.2
<b>B</b>	Equivalent no. of contacts - 2
<b>C</b>	B + 7
<b>D</b>	B + 0.8

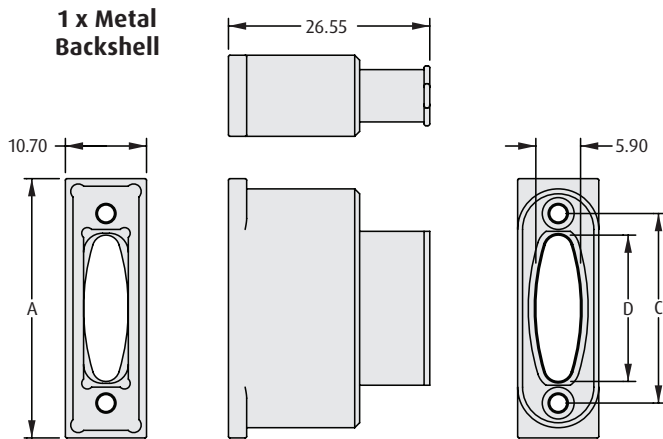

4 x E-Clip  
(2 spare)

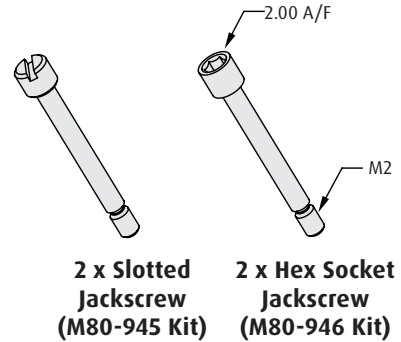

2 x Slotted  
Jackscrew  
(M80-945 Kit)

2 x Hex Socket  
Jackscrew  
(M80-946 Kit)

### E-CLIP TOOL



- ❖ For assembling E-Clips supplied with kit.

### ORDER CODE

**Z80-300**

### BAND-IT TIE



- ❖ For fixing braid to rear collar (requires Tie Dex II A30199 Micro Band tool).

### ORDER CODE

<b>M80-9470000</b>	Length = 206.8mm
<b>M80-9480000</b>	Length = 362.0mm

### HOW TO ORDER

**M80 - 94 X XX 02**

### SERIES CODE

### TYPE

<b>5</b>	With Slotted Jackscrews
<b>6</b>	With Hex Socket Jackscrews

### FINISH

**02** Nickel

### EQUIVALENT NO. OF SIGNAL CONTACTS

**08 to 28, 32 to 50 (Even numbers only)**

All dimensions in mm.

# Datamate J-Tek Connectors

DATAMATE J-TEK

## Male Vertical Throughboard

- Polarized housings.
- Fully shrouded contacts.
- Jackscrews are assembled where specified.
- Choice of throughboard termination length.
- Board Mount provides PCB strain relief.
- Mates with female Datamate J-Tek connectors with compatible jackscrews.

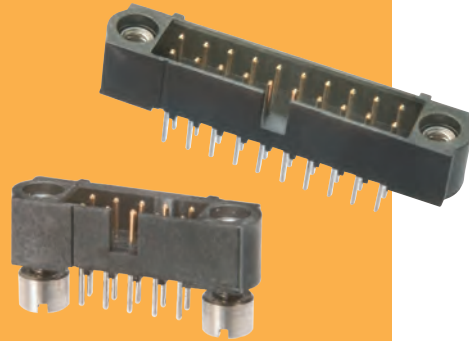

WITHOUT JACKSCREWS		WITH JACKSCREWS		WITH BOARD MOUNT		CALCULATION							
				<p><b>Board Mount Nut, 2 per connector</b></p> <p>Ø4.00, M2, 3.00</p>		<table border="1"> <tr> <td><b>A</b></td> <td>B + 12</td> </tr> <tr> <td><b>B</b></td> <td>Total no. of contacts - 2</td> </tr> <tr> <td><b>C</b></td> <td>B + 7</td> </tr> </table>		<b>A</b>	B + 12	<b>B</b>	Total no. of contacts - 2	<b>C</b>	B + 7
<b>A</b>	B + 12												
<b>B</b>	Total no. of contacts - 2												
<b>C</b>	B + 7												
<p>Recommended PC Board Pattern</p>													
HOW TO ORDER													
<b>M80 - 5 X X XX XX</b>													
<b>SERIES CODE</b>						<b>FINISH</b>							
0	With Jackscrews					05	Gold						
1	With Board Mount					42	Gold + Tin						
2	Without Jackscrews												
						<b>TOTAL NO. OF CONTACTS</b>							
0	3mm Tails					04, 06, 08, 10, 12, 14, 20, 26, 34, 42, 50							
1	4.5mm Tails												

All dimensions in mm.

# Datamate J-Tek Connectors

## Male Vertical Throughboard 101Lok

- ❖ 101Lok fixing gives secure, fast and simple mating; no special tooling required. Just a simple 101-degree turn is required to fix the connectors together.
- ❖ Connectors mate with Datamate J-Tek female connectors with applicable 101Lok fixings.
- ❖ Board Mount provides PCB strain relief.
- ❖ Choice of throughboard termination length.

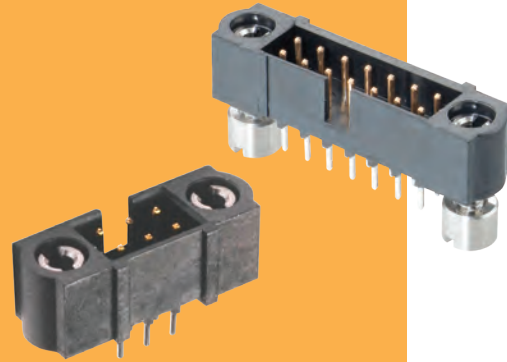

### 101LOK

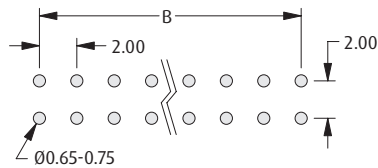
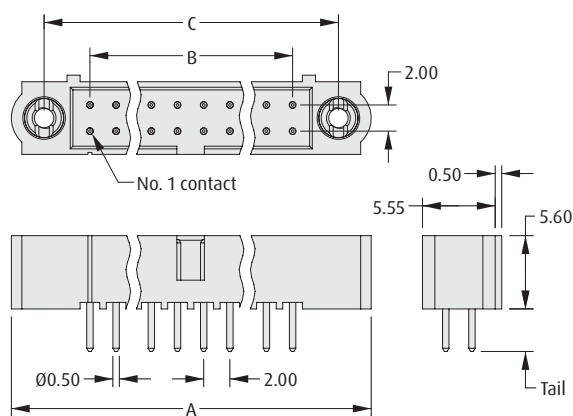

Recommended PC Board Pattern

CALCULATION	
<b>A</b>	$B + 12$
<b>B</b>	Total no. of contacts - 2
<b>C</b>	$B + 7$

### 101LOK WITH BOARD MOUNT

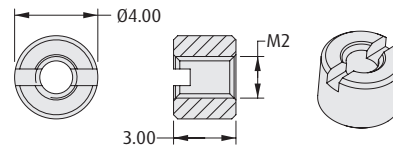
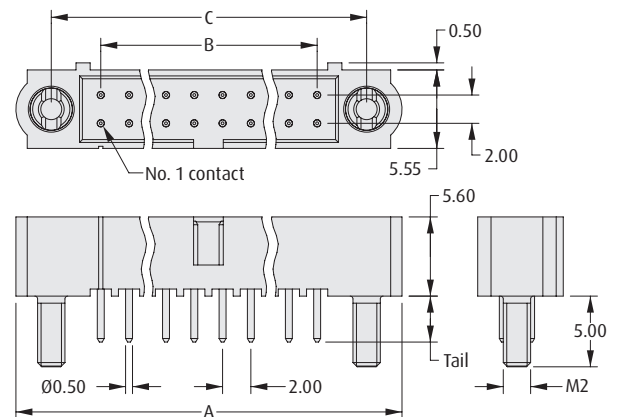

Board Mount Nut, 2 per connector

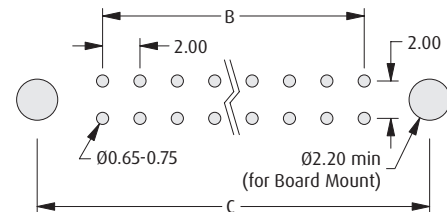

Recommended PC Board Pattern

### HOW TO ORDER

**M80 - 5 TX XX XX MX**

#### SERIES CODE

#### TYPE

<b>T1</b>	3mm Tails
<b>T2</b>	4.5mm Tails

#### TOTAL NO. OF CONTACTS

**04, 06, 08, 10, 12, 14, 20, 26, 34, 42, 50**

#### JACKSCREW

<b>MC</b>	101Lok
<b>ME</b>	101Lok with Board Mount

#### FINISH

<b>05</b>	Gold
<b>42</b>	Gold + Tin

All dimensions in mm.

# Datamate J-Tek Connectors

DATAMATE J-TEK

## Male Horizontal Throughboard

- Polarized housings.
- Fully shrouded contacts.
- Jackscrews are assembled where specified.
- Choice of throughboard termination length.
- Board Mount provides PCB strain relief.
- Mates with female Datamate J-Tek connectors with compatible jackscrews.

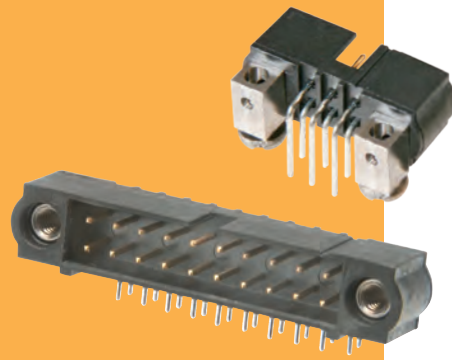

### WITHOUT JACKSCREWS

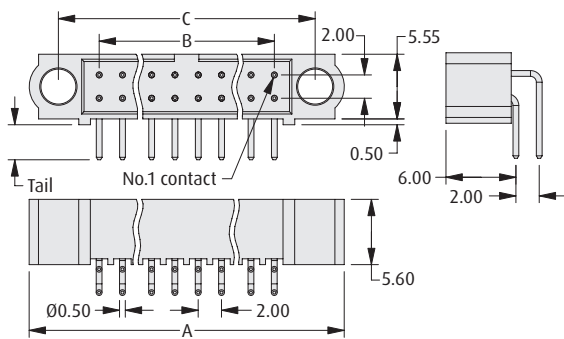

### CALCULATION

<b>A</b>	B + 12
<b>B</b>	Total no. of contacts - 2
<b>C</b>	B + 7

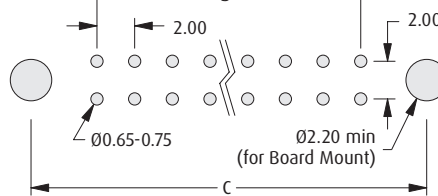

Recommended PC Board Pattern

### WITH JACKSCREWS

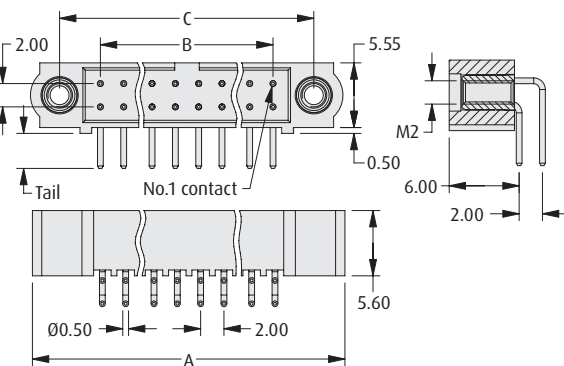

### WITH BOARD MOUNT

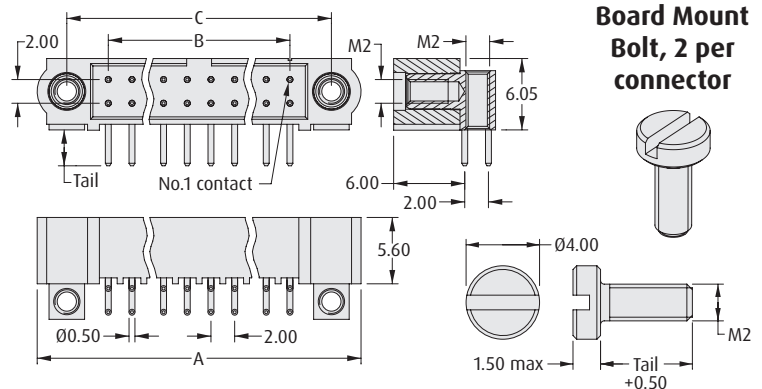

### HOW TO ORDER

**M80 - 5 X X XX XX**

#### SERIES CODE

<b>3</b>	With Jackscrews
<b>4</b>	With Board Mount
<b>5</b>	Without Jackscrews

<b>0</b>	3mm Tails
<b>1</b>	4.5mm Tails

#### FINISH

<b>05</b>	Gold
<b>42</b>	Gold + Tin

#### TOTAL NO. OF CONTACTS

**04, 06, 08, 10, 12, 14, 20, 26, 34, 42, 50**

All dimensions in mm.

# Datamate J-Tek Connectors

## Male Horizontal Throughboard 101Lok

- ❖ 101Lok fixing gives secure, fast and simple mating; no special tooling required. Just a simple 101-degree turn is required to fix the connectors together.
- ❖ Connectors mate with Datamate J-Tek female connectors with applicable 101Lok fixings.
- ❖ Board Mount provides PCB strain relief.
- ❖ Choice of throughboard termination length.

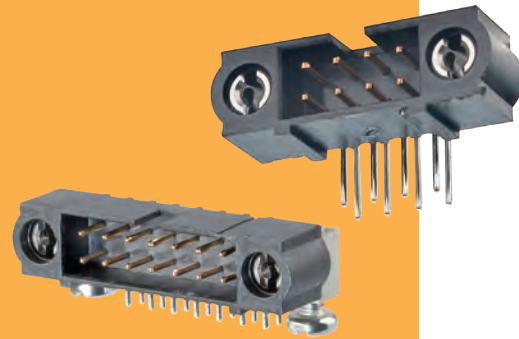

### 101LOK

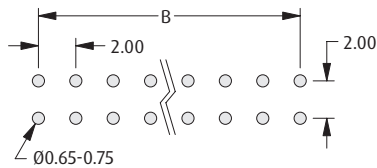
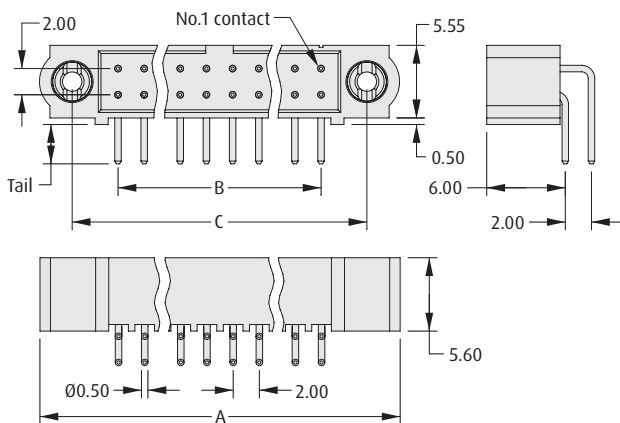

Recommended PC Board Pattern

CALCULATION	
<b>A</b>	$B + 12$
<b>B</b>	Total no. of contacts - 2
<b>C</b>	$B + 7$

### 101LOK WITH BOARD MOUNT

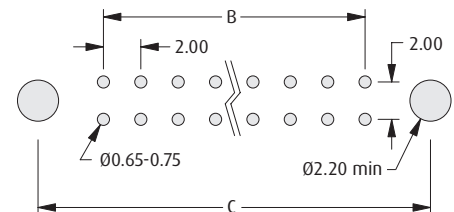
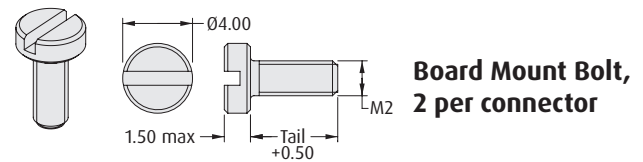
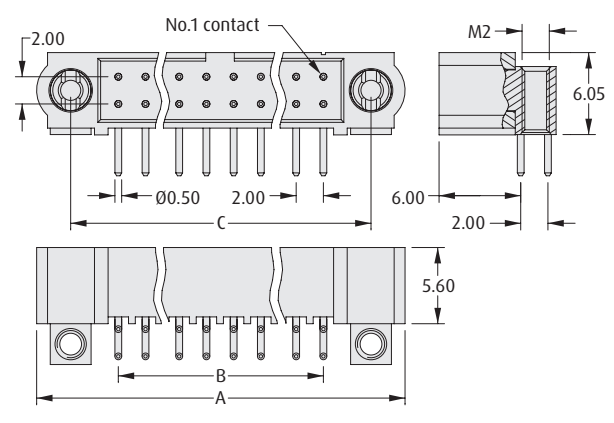

Recommended PC Board Pattern

## HOW TO ORDER

**M80 - 5 LX XX XX MX**

#### SERIES CODE

#### TYPE

<b>L1</b>	3mm Tails
<b>L2</b>	4.5mm Tails

#### TOTAL NO. OF CONTACTS

**04, 06, 08, 10, 12, 14, 20, 26, 34, 42, 50**

#### JACKSCREW

<b>MC</b>	101Lok
<b>MD</b>	101Lok with Board Mount

#### FINISH

<b>05</b>	Gold
<b>42</b>	Gold + Tin

All dimensions in mm.



# Datamate J-Tek Connectors

DATAMATE J-TEK

## Male Vertical Surface Mount

- Gull wing SMT tails simplify inspection process.
- Board Mount provides PCB strain relief.
- Optional pick and place cap.
- Mates with female Datamate J-Tek connectors with compatible jackscrews.



WITHOUT JACKSCREWS		WITH JACKSCREWS		WITH BOARD MOUNT													
<p><b>RECOMMENDED PC BOARD PATTERN</b></p>		<p><b>CALCULATION</b></p> <table border="1"> <tr> <td><b>A</b></td> <td>B + 12</td> </tr> <tr> <td><b>B</b></td> <td>Total no. of contacts - 2</td> </tr> <tr> <td><b>C</b></td> <td>B + 7</td> </tr> </table>		<b>A</b>	B + 12	<b>B</b>	Total no. of contacts - 2	<b>C</b>	B + 7								
<b>A</b>	B + 12																
<b>B</b>	Total no. of contacts - 2																
<b>C</b>	B + 7																
<b>HOW TO ORDER</b>																	
<b>M80 - 5 XX XX XX P</b>																	
<p><b>SERIES CODE</b></p>		<p><b>TOTAL NO. OF CONTACTS</b></p> <p>04, 06, 08, 10, 12, 14, 20, 26, 34, 42, 50</p>		<p><b>PICK AND PLACE CAP</b></p> <table border="1"> <tr> <td><b>BLANK</b></td> <td>No Cap</td> </tr> <tr> <td><b>P</b></td> <td>Pick &amp; Place Cap</td> </tr> </table>		<b>BLANK</b>	No Cap	<b>P</b>	Pick & Place Cap								
<b>BLANK</b>	No Cap																
<b>P</b>	Pick & Place Cap																
<p><b>TYPE</b></p> <table border="1"> <tr> <td><b>02</b></td> <td>With Jackscrews</td> </tr> <tr> <td><b>12</b></td> <td>With 3.5mm Board Mount</td> </tr> <tr> <td><b>13</b></td> <td>With 5mm Board Mount</td> </tr> <tr> <td><b>22</b></td> <td>Without Jackscrews</td> </tr> </table>		<b>02</b>	With Jackscrews	<b>12</b>	With 3.5mm Board Mount	<b>13</b>	With 5mm Board Mount	<b>22</b>	Without Jackscrews			<p><b>FINISH</b></p> <table border="1"> <tr> <td><b>05</b></td> <td>Gold</td> </tr> <tr> <td><b>42</b></td> <td>Gold + Tin</td> </tr> </table>		<b>05</b>	Gold	<b>42</b>	Gold + Tin
<b>02</b>	With Jackscrews																
<b>12</b>	With 3.5mm Board Mount																
<b>13</b>	With 5mm Board Mount																
<b>22</b>	Without Jackscrews																
<b>05</b>	Gold																
<b>42</b>	Gold + Tin																

All dimensions in mm.

# Datamate J-Tek Connectors

## Male Vertical Surface Mount 101Lok

- ❖ 101Lok fixing gives secure, fast and simple mating; no special tooling required. Just a simple 101-degree turn is required to fix the connectors together.
- ❖ Connectors mate with Datamate J-Tek female connectors with applicable 101Lok fixings.
- ❖ Board Mount provides PCB strain relief.
- ❖ Gull wing SMT tails simplify inspection process.

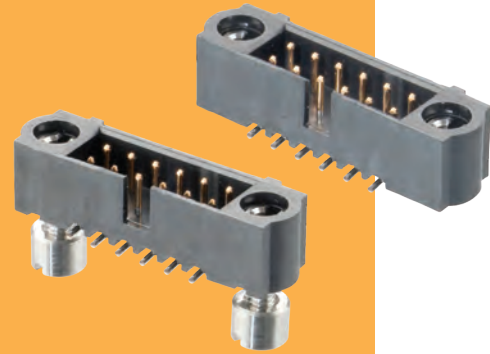

### 101LOK

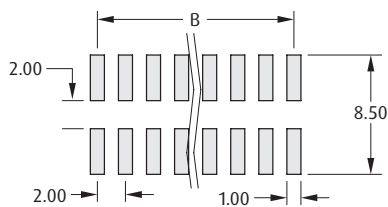
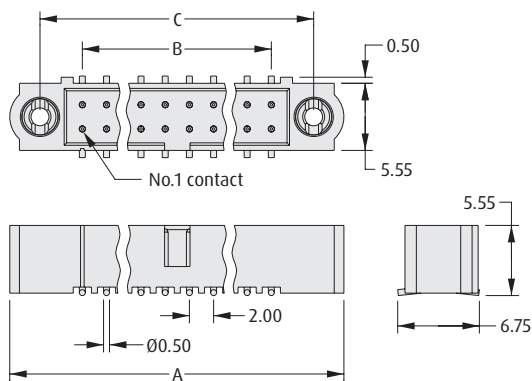

Recommended PC Board Pattern

CALCULATION	
<b>A</b>	$B + 12$
<b>B</b>	Total no. of contacts - 2
<b>C</b>	$B + 7$

### 101LOK WITH BOARD MOUNT

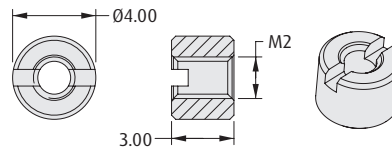
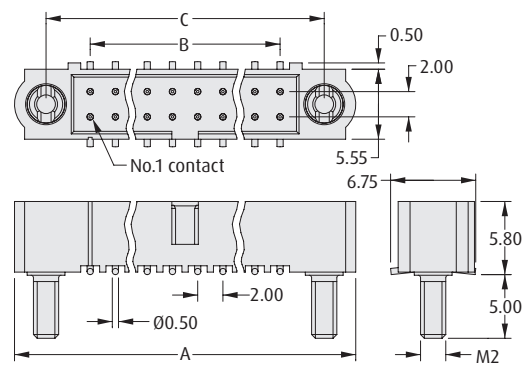

Board Mount Nut,  
2 per connector

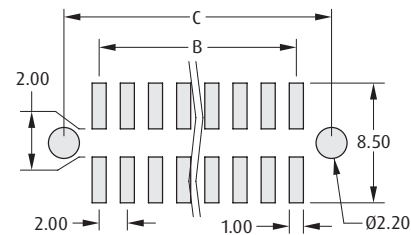

Recommended PC Board Pattern

### HOW TO ORDER

**M80 - 5S1 XX XX MX**

**SERIES CODE**

**TOTAL NO. OF CONTACTS**

**04, 06, 08, 10, 12, 14, 20, 26, 34, 42, 50**

**JACKSCREW**

<b>MC</b>	101Lok
<b>ME</b>	101Lok with 5mm Board Mount

**FINISH**

<b>05</b>	Gold
<b>42</b>	Gold + Tin

All dimensions in mm.

# Datamate J-Tek Connectors

DATAMATE J-TEK

## Male Horizontal Surface Mount

- Stamped contact ensures co-planarity.
- Board Mount provides PCB strain relief.
- Mates with female Datamate J-Tek connectors with compatible jackscrews.

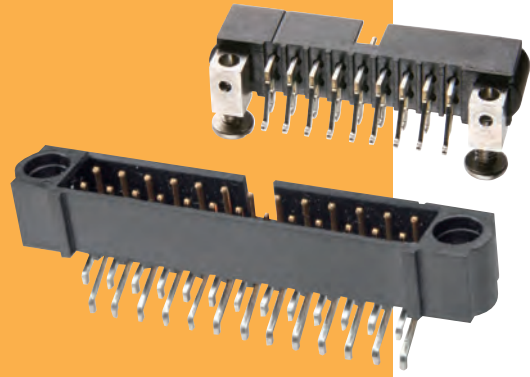

WITHOUT JACKSCREWS		WITH JACKSCREWS		WITH BOARD MOUNT																	
				<p><b>Board Mount Bolt, 2 per connector</b></p>																	
				<p><b>Recommended PC Board Pattern</b></p>																	
				<p><b>CALCULATION</b></p> <table border="1"> <tr> <td><b>A</b></td> <td><math>B + 12</math></td> </tr> <tr> <td><b>B</b></td> <td>Total no. of contacts - 2</td> </tr> <tr> <td><b>C</b></td> <td><math>B + 7</math></td> </tr> </table>		<b>A</b>	$B + 12$	<b>B</b>	Total no. of contacts - 2	<b>C</b>	$B + 7$										
<b>A</b>	$B + 12$																				
<b>B</b>	Total no. of contacts - 2																				
<b>C</b>	$B + 7$																				
<b>HOW TO ORDER</b>																					
<b>M80 - 5 XX XX XX</b>																					
<p><b>SERIES CODE</b></p>																					
<table border="1"> <thead> <tr> <th colspan="2">TYPE</th> </tr> </thead> <tbody> <tr> <td>32</td> <td>With Jackscrews</td> </tr> <tr> <td>42</td> <td>With 3.5mm Board Mount</td> </tr> <tr> <td>43</td> <td>With 5mm Board Mount</td> </tr> <tr> <td>52</td> <td>Without Jackscrews</td> </tr> </tbody> </table>		TYPE		32	With Jackscrews	42	With 3.5mm Board Mount	43	With 5mm Board Mount	52	Without Jackscrews			<table border="1"> <thead> <tr> <th colspan="2">FINISH</th> </tr> </thead> <tbody> <tr> <td>05</td> <td>Gold</td> </tr> <tr> <td>42</td> <td>Gold + Tin</td> </tr> </tbody> </table>		FINISH		05	Gold	42	Gold + Tin
TYPE																					
32	With Jackscrews																				
42	With 3.5mm Board Mount																				
43	With 5mm Board Mount																				
52	Without Jackscrews																				
FINISH																					
05	Gold																				
42	Gold + Tin																				
				<table border="1"> <thead> <tr> <th colspan="2">TOTAL NO. OF CONTACTS</th> </tr> </thead> <tbody> <tr> <td colspan="2">04, 06, 08, 10, 12, 14, 20, 26, 34, 42, 50</td> </tr> </tbody> </table>		TOTAL NO. OF CONTACTS		04, 06, 08, 10, 12, 14, 20, 26, 34, 42, 50													
TOTAL NO. OF CONTACTS																					
04, 06, 08, 10, 12, 14, 20, 26, 34, 42, 50																					

All dimensions in mm.

# Datamate J-Tek Connectors

## Male Horizontal Surface Mount 101Lok

- ❖ 101Lok fixing gives secure, fast and simple mating; no special tooling required. Just a simple 101-degree turn is required to fix the connectors together.
- ❖ Connectors mate with Datamate J-Tek female connectors with applicable 101Lok fixings.
- ❖ Board Mount provides PCB strain relief.
- ❖ Stamped contact ensures co-planarity.

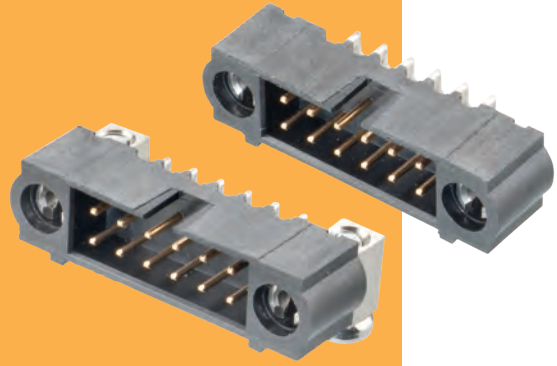

### 101LOK

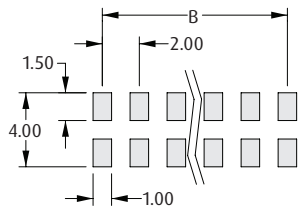
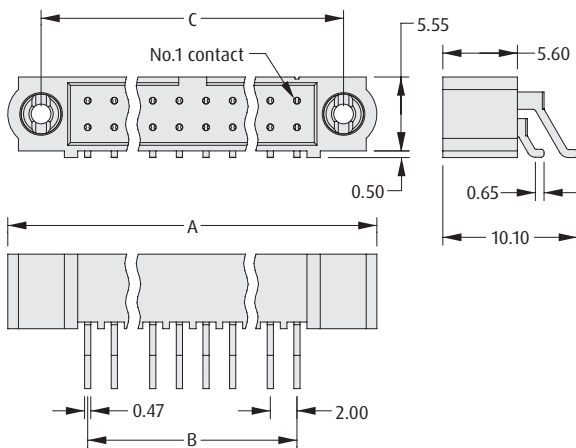

Recommended PC Board Pattern

CALCULATION	
<b>A</b>	$B + 12$
<b>B</b>	Total no. of contacts - 2
<b>C</b>	$B + 7$

### 101LOK WITH BOARD MOUNT

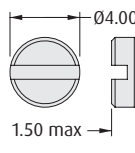
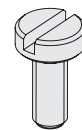
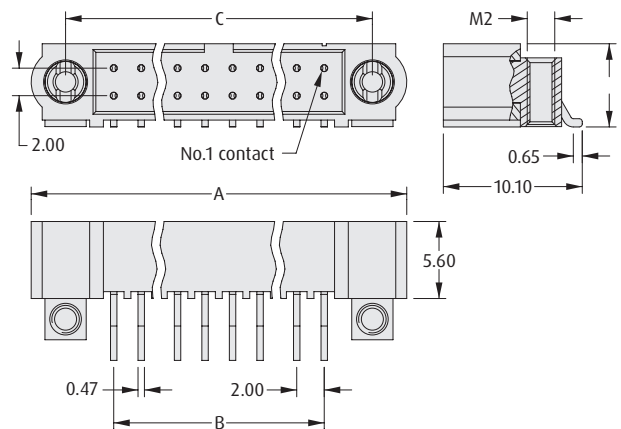

**Board Mount Bolt, 2 per connector**

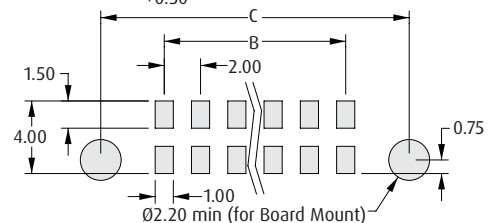

Recommended PC Board Pattern

### HOW TO ORDER

**M80 - 5S2 XX XX MX**

**SERIES CODE**

**TOTAL NO. OF CONTACTS**

**04, 06, 08, 10, 12, 14, 20, 26, 34, 42, 50**

**JACKSCREW**

<b>MC</b>	101Lok
<b>MD</b>	101Lok with Board Mount

**FINISH**

<b>05</b>	Gold
<b>42</b>	Gold + Tin

All dimensions in mm.

# Datamate J-Tek Connectors

DATAMATE J-TEK

## Male Crimp Kit

- Part numbers are for a complete kit of a housing and the applicable number of contacts.
- Jackscrews are assembled where specified.
- Crimp contacts supplied loose.
- Crimp contacts are rear insertable and replaceable.
- Spare contacts are available.

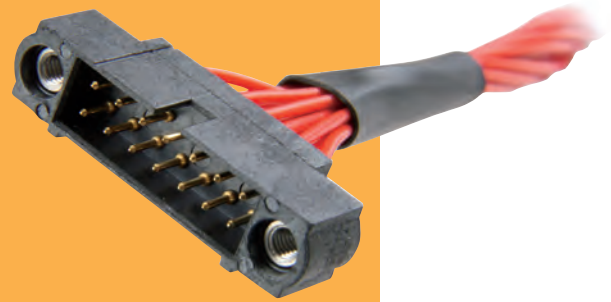

WITHOUT JACKSCREWS	WITH JACKSCREWS																
<table border="1" style="background-color: #f4a460; width: 100%;"> <thead> <tr> <th colspan="2">CALCULATION</th> </tr> </thead> <tbody> <tr> <td><b>A</b></td> <td><math>B + 12</math></td> </tr> <tr> <td><b>B</b></td> <td>Total no. of contacts - 2</td> </tr> <tr> <td><b>C</b></td> <td><math>B + 7</math></td> </tr> </tbody> </table>		CALCULATION		<b>A</b>	$B + 12$	<b>B</b>	Total no. of contacts - 2	<b>C</b>	$B + 7$								
CALCULATION																	
<b>A</b>	$B + 12$																
<b>B</b>	Total no. of contacts - 2																
<b>C</b>	$B + 7$																
TOOLS	WIRE STRIPPING DETAILS																
<p><b>Recommended Crimp Tool</b> - M22520/2-01</p> <p><b>Positioner</b> - Z80-193</p> <p><b>Contact Insertion/Removal Tool</b> - Z80-280</p> <ul style="list-style-type: none"> <li>Spare contacts shown on following pages.</li> <li>Instruction sheets available at <a href="http://www.harwin.com/instructions">www.harwin.com/instructions</a>.</li> </ul>																	
HOW TO ORDER																	
<p><b>M80 - 5XX XX 05</b></p>																	
<table border="1" style="width: 100%;"> <thead> <tr> <th colspan="2">SERIES CODE</th> </tr> </thead> <tbody> <tr> <th>TYPE</th> <td></td> </tr> <tr> <td><b>570</b></td> <td>Large Bore (22 AWG), without Jackscrews</td> </tr> <tr> <td><b>571</b></td> <td>Small Bore (24-28 AWG), without Jackscrews</td> </tr> <tr> <td><b>560</b></td> <td>Large Bore (22 AWG), with Jackscrews</td> </tr> <tr> <td><b>561</b></td> <td>Small Bore (24-28 AWG), with Jackscrews</td> </tr> </tbody> </table>	SERIES CODE		TYPE		<b>570</b>	Large Bore (22 AWG), without Jackscrews	<b>571</b>	Small Bore (24-28 AWG), without Jackscrews	<b>560</b>	Large Bore (22 AWG), with Jackscrews	<b>561</b>	Small Bore (24-28 AWG), with Jackscrews	<table border="1" style="width: 100%;"> <thead> <tr> <th colspan="2">FINISH</th> </tr> </thead> <tbody> <tr> <td><b>05</b></td> <td>Gold</td> </tr> </tbody> </table>	FINISH		<b>05</b>	Gold
SERIES CODE																	
TYPE																	
<b>570</b>	Large Bore (22 AWG), without Jackscrews																
<b>571</b>	Small Bore (24-28 AWG), without Jackscrews																
<b>560</b>	Large Bore (22 AWG), with Jackscrews																
<b>561</b>	Small Bore (24-28 AWG), with Jackscrews																
FINISH																	
<b>05</b>	Gold																
<table border="1" style="width: 100%;"> <thead> <tr> <th>TOTAL NO. OF CONTACTS</th> </tr> </thead> <tbody> <tr> <td><b>04, 06, 08, 10, 12, 14, 20, 26, 34, 42, 50</b></td> </tr> </tbody> </table>		TOTAL NO. OF CONTACTS	<b>04, 06, 08, 10, 12, 14, 20, 26, 34, 42, 50</b>														
TOTAL NO. OF CONTACTS																	
<b>04, 06, 08, 10, 12, 14, 20, 26, 34, 42, 50</b>																	

All dimensions in mm.

# Datamate J-Tek Connectors

## Male Crimp Kit 101Lok

- ❖ Part numbers are for a complete kit of a housing and the applicable number of contacts.
- ❖ 101Lok fixing gives secure, fast and simple mating; no special tooling required. Just a simple 101-degree turn is required to fix the connectors together.
- ❖ Connectors mate with Datamate J-Tek female connectors with applicable 101Lok fixings.
- ❖ Crimp contacts supplied loose.

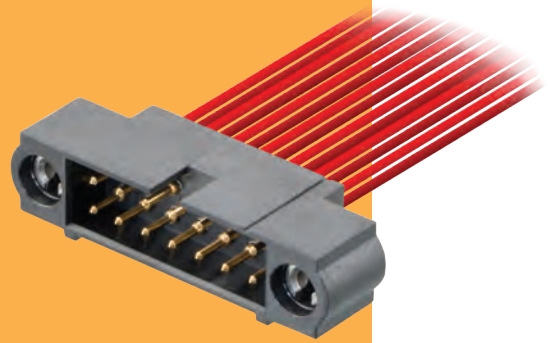

DATAMATE J-TEK

101LOK		CALCULATION	
		<b>A</b>	B + 12
		<b>B</b>	Total no. of contacts - 2
		<b>C</b>	B + 7
TOOLS		WIRE STRIPPING DETAILS	
<p><b>Recommended Crimp Tool</b> - M22520/2-01  <b>Positioner</b> - Z80-193  <b>Contact Insertion/Removal Tool</b> - Z80-280</p> <ul style="list-style-type: none"> <li>❖ Spare contacts shown on following pages.</li> <li>❖ Instruction sheets available at <a href="http://www.harwin.com/instructions">www.harwin.com/instructions</a>.</li> </ul>			
HOW TO ORDER			
<b>M80 - 5 X1 XX 05 MC</b>			
<b>SERIES CODE</b>			<b>JACKSCREW</b>
<b>TYPE</b>			<b>MC</b> 101Lok
<b>C1</b> Small Bore (24-28 AWG)			<b>FINISH</b>
<b>D1</b> Large Bore (22 AWG)			<b>05</b> Gold
<b>TOTAL NO. OF CONTACTS</b>			
<b>04, 06, 08, 10, 12, 14, 20, 26, 34, 42, 50</b>			

All dimensions in mm.

# Datamate J-Tek Connectors

DATAMATE J-TEK

## Male Crimp Kit Reverse Fix

- Allows for further flexibility in system design.
- Part numbers are for a complete kit of a housing and the applicable number of contacts.
- Crimp contacts are rear insertable and replaceable.
- Mates with female Datamate J-Tek connectors with compatible Reverse Fix jackscrews.



REVERSE FIX		CALCULATION													
		<b>A</b>	$B + 12$												
		<b>B</b>	Total no. of contacts - 2												
		<b>C</b>	$B + 7$												
TOOLS		WIRE STRIPPING DETAILS													
<p><b>Recommended Crimp Tool</b> - M22520/2-01  <b>Positioner</b> - Z80-193  <b>Contact Insertion/Removal Tool</b> - Z80-280</p> <ul style="list-style-type: none"> <li>Spare contacts shown on following pages.</li> <li>Instruction sheets available at <a href="http://www.harwin.com/instructions">www.harwin.com/instructions</a>.</li> </ul>															
HOW TO ORDER															
<b>M80 - 5XX XX 05</b>															
<p><b>SERIES CODE</b></p> <table border="1"> <thead> <tr> <th colspan="2">TYPE</th> </tr> </thead> <tbody> <tr> <td><b>562</b></td> <td>Large Bore (22 AWG), Slotted Jackscrew</td> </tr> <tr> <td><b>563</b></td> <td>Small Bore (24-28 AWG), Slotted Jackscrew</td> </tr> <tr> <td><b>582</b></td> <td>Large Bore (22 AWG), Hex Socket Jackscrew</td> </tr> <tr> <td><b>583</b></td> <td>Small Bore (24-28 AWG), Hex Socket Jackscrew</td> </tr> </tbody> </table>		TYPE		<b>562</b>	Large Bore (22 AWG), Slotted Jackscrew	<b>563</b>	Small Bore (24-28 AWG), Slotted Jackscrew	<b>582</b>	Large Bore (22 AWG), Hex Socket Jackscrew	<b>583</b>	Small Bore (24-28 AWG), Hex Socket Jackscrew	<p><b>FINISH</b></p> <table border="1"> <tbody> <tr> <td><b>05</b></td> <td>Gold</td> </tr> </tbody> </table>		<b>05</b>	Gold
TYPE															
<b>562</b>	Large Bore (22 AWG), Slotted Jackscrew														
<b>563</b>	Small Bore (24-28 AWG), Slotted Jackscrew														
<b>582</b>	Large Bore (22 AWG), Hex Socket Jackscrew														
<b>583</b>	Small Bore (24-28 AWG), Hex Socket Jackscrew														
<b>05</b>	Gold														
		<p><b>TOTAL NO. OF CONTACTS</b></p> <p>04, 06, 08, 10, 12, 14, 20, 26, 34, 42, 50</p>													

All dimensions in mm.

# Datamate J-Tek Connectors

## Male Crimp Kit Extended Wall

- Extended Wall Datamate allows back potting to be performed.
- Fully shrouded contacts.
- Large Bore 22 AWG, Small Bore 24 – 28 AWG.
- Part numbers are for a complete kit of a housing and the applicable number of contacts.
- Crimp contacts are rear insertable and replaceable.
- Crimp contacts supplied loose.

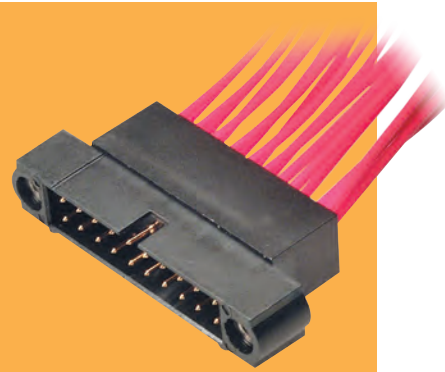

DATAMATE J-TEK

WITHOUT JACKSCREWS	WITH JACKSCREWS												
<table border="1" style="margin-left: 20px;"> <thead> <tr> <th colspan="2" style="background-color: #f4a460;">CALCULATION</th> </tr> </thead> <tbody> <tr> <td style="background-color: #f4a460;">A</td> <td>B + 12</td> </tr> <tr> <td style="background-color: #f4a460;">B</td> <td>Total no. of contacts - 2</td> </tr> <tr> <td style="background-color: #f4a460;">C</td> <td>B + 7</td> </tr> </tbody> </table>	CALCULATION		A	B + 12	B	Total no. of contacts - 2	C	B + 7					
CALCULATION													
A	B + 12												
B	Total no. of contacts - 2												
C	B + 7												
<h3>TOOLS</h3> <p><b>Recommended Crimp Tool</b> - M22520/2-01  <b>Positioner</b> - Z80-193  <b>Contact Insertion/Removal Tool</b> - Z80-280</p> <ul style="list-style-type: none"> <li>Spare contacts shown on following pages.</li> <li>Instruction sheets available at <a href="http://www.harwin.com/instructions">www.harwin.com/instructions</a>.</li> </ul>	<h3>WIRE STRIPPING DETAILS</h3>												
<h3>HOW TO ORDER</h3>													
<h2>M80 - 5XX XX 05 X</h2>													
<h4>SERIES CODE</h4>	<h4>WALL SIZE</h4> <table border="1"> <tr> <td style="background-color: #f4a460;">BLANK</td> <td>Wall = 5mm</td> </tr> <tr> <td style="background-color: #f4a460;">A</td> <td>Wall = 1mm</td> </tr> </table>	BLANK	Wall = 5mm	A	Wall = 1mm								
BLANK	Wall = 5mm												
A	Wall = 1mm												
<table border="1"> <thead> <tr> <th colspan="2" style="background-color: #f4a460;">TYPE</th> </tr> </thead> <tbody> <tr> <td style="background-color: #f4a460;">575</td> <td>Large Bore (22 AWG), without Jackscrews</td> </tr> <tr> <td style="background-color: #f4a460;">576</td> <td>Small Bore (24-28 AWG), without Jackscrews</td> </tr> <tr> <td style="background-color: #f4a460;">565</td> <td>Large Bore (22 AWG), with Jackscrews</td> </tr> <tr> <td style="background-color: #f4a460;">566</td> <td>Small Bore (24-28 AWG), with Jackscrews</td> </tr> </tbody> </table>	TYPE		575	Large Bore (22 AWG), without Jackscrews	576	Small Bore (24-28 AWG), without Jackscrews	565	Large Bore (22 AWG), with Jackscrews	566	Small Bore (24-28 AWG), with Jackscrews	<h4>FINISH</h4> <table border="1"> <tr> <td style="background-color: #f4a460;">05</td> <td>Gold</td> </tr> </table>	05	Gold
TYPE													
575	Large Bore (22 AWG), without Jackscrews												
576	Small Bore (24-28 AWG), without Jackscrews												
565	Large Bore (22 AWG), with Jackscrews												
566	Small Bore (24-28 AWG), with Jackscrews												
05	Gold												
<h4>TOTAL NO. OF CONTACTS</h4> <table border="1"> <tr> <td style="background-color: #f4a460;">06, 10, 14, 20, 26, 34</td> </tr> </table>		06, 10, 14, 20, 26, 34											
06, 10, 14, 20, 26, 34													

All dimensions in mm.



# Datamate J-Tek Connectors

## Male Crimp with Hood

- Supplied as a complete kit: jackscrews assembled to housing; hood, contacts and assembly screws supplied loose.
- Provides strain relief by preventing cable bending at the rear of the connector, and also the option of inserting a cable tie to reduce pull strain.

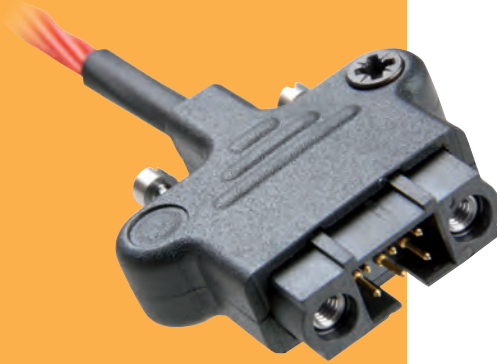

DATAMATE J-TEK

MALE		CALCULATION	
		<b>A</b>	$B + 21.5$
		<b>B</b>	Total no. of contacts - 2
		<b>C</b>	$B + 7$
TOOLS		WIRE STRIPPING DETAILS	
<p><b>Recommended Crimp Tool</b> - M22520/2-01</p> <p><b>Positioner</b> - Z80-193</p> <p><b>Contact Insertion/Removal Tool</b> - Z80-280</p> <ul style="list-style-type: none"> <li>➤ Spare contacts shown on following pages.</li> <li>➤ Instruction sheets available at <a href="http://www.harwin.com/instructions">www.harwin.com/instructions</a>.</li> </ul>			
HOW TO ORDER			
<b>M80 - 94 X XX 05</b>			
<b>SERIES CODE</b>		<b>FINISH</b>	
<b>TYPE</b>		<b>05</b>	Gold
<b>2</b>	Small Bore (24-28 AWG)		
<b>3</b>	Large Bore (22 AWG)		
		<b>TOTAL NO. OF CONTACTS</b>	
			<b>06, 08, 10, 12, 14, 20, 26, 34, 42, 50</b>

All dimensions in mm.

# Datamate J-Tek Connectors

## Spare Male Crimp Contacts

- Barrel Crimp Contacts are supplied with the connectors - see previous page. Use the order code for extra spare crimps.

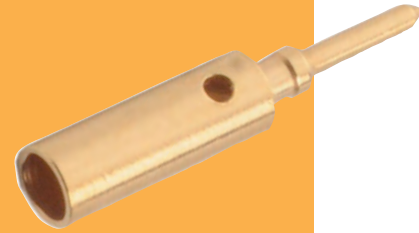

DATAMATE J-TEK

CRIMP CONTACTS	WIRE STRIPPING DETAILS						
<p><b>Large Bore (22 AWG)</b></p>							
<p><b>Small Bore (24 to 28 AWG)</b></p>							
<b>TOOLS</b>							
<p><b>Recommended Crimp Tool</b> - M22520/2-01  <b>Positioner</b> - Z80-193  <b>Contact Insertion/Removal Tool</b> - Z80-280</p> <p>❖ Instruction sheets available at <a href="http://www.harwin.com/instructions">www.harwin.com/instructions</a>.</p>							
<b>HOW TO ORDER</b>							
<p><b>M80 - 19 X 00 05</b></p>							
<p><b>SERIES CODE</b></p>	<p><b>FINISH</b></p> <table border="1"> <tr> <td><b>05</b></td> <td>Gold</td> </tr> </table>	<b>05</b>	Gold				
<b>05</b>	Gold						
<table border="1"> <thead> <tr> <th colspan="2">TYPE</th> </tr> </thead> <tbody> <tr> <td><b>4</b></td> <td>Large Bore (22 AWG)</td> </tr> <tr> <td><b>5</b></td> <td>Small Bore (24-28 AWG)</td> </tr> </tbody> </table>	TYPE		<b>4</b>	Large Bore (22 AWG)	<b>5</b>	Small Bore (24-28 AWG)	
TYPE							
<b>4</b>	Large Bore (22 AWG)						
<b>5</b>	Small Bore (24-28 AWG)						

All dimensions in mm.

# Datamate J-Tek Connectors

## Male Cable Assemblies

- Ready-made cable assemblies, fully tested and inspected.
- Stainless steel jackscrews to mate with applicable male connector.
- Constructed with Contact 1 to Contact 1, Contact 2 to Contact 2, etc.
- For multicolor sequence, check applicable Technical Drawing.

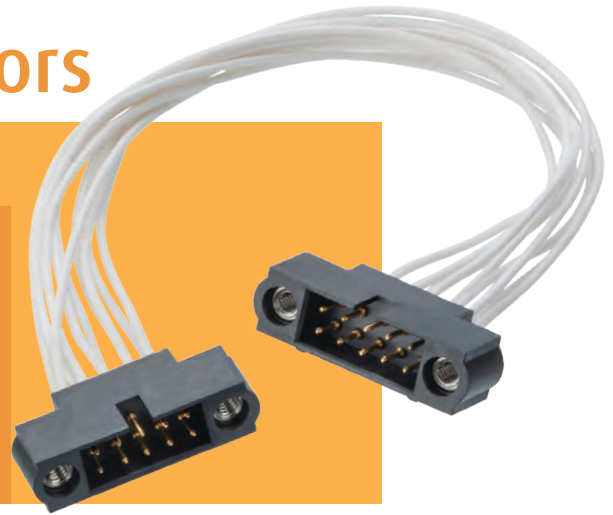

### PART NUMBERING SYSTEM

**M80 - M X X XX XX MX - XXXX XX**

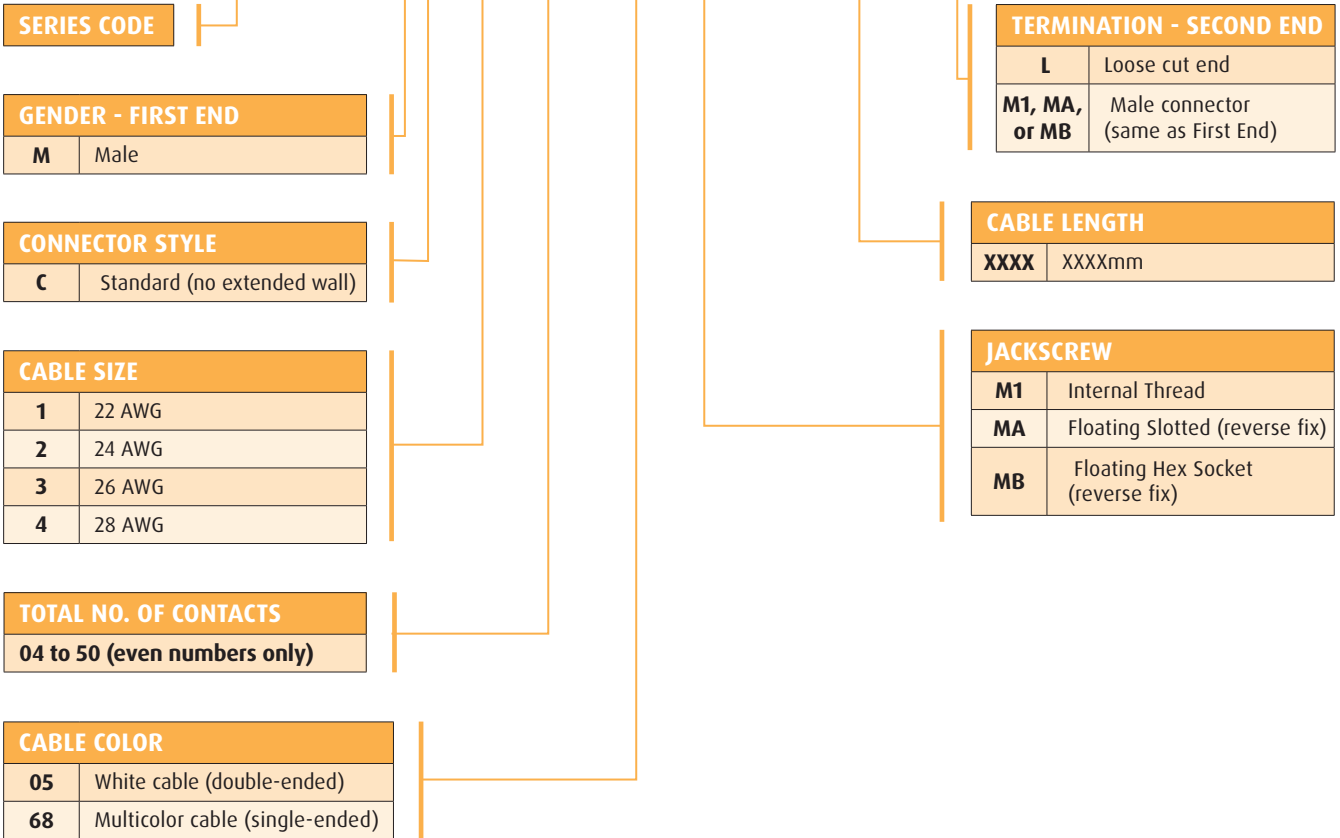

All dimensions in mm.

# Datamate J-Tek Connectors

- ❖ Examples of available cable assembly options - see previous page for part numbering.
- ❖ Cable assemblies are constructed with Contact 1 to Contact 1, Contact 2 to Contact 2, etc.

## MALE SINGLE ENDED

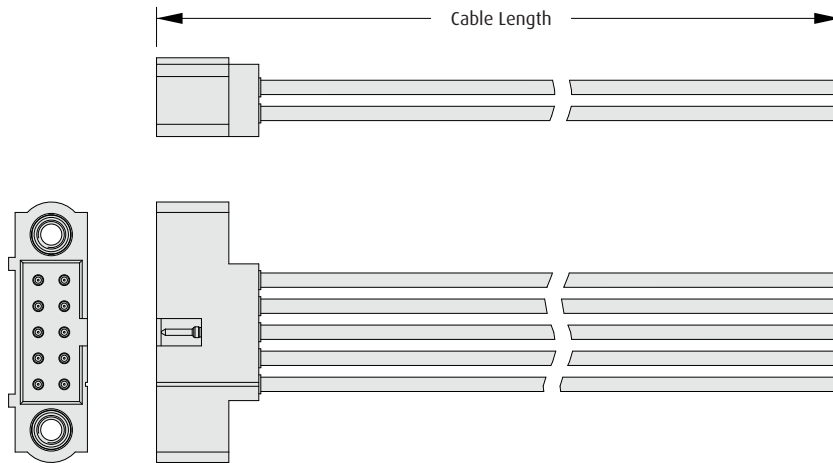

## MALE - MALE

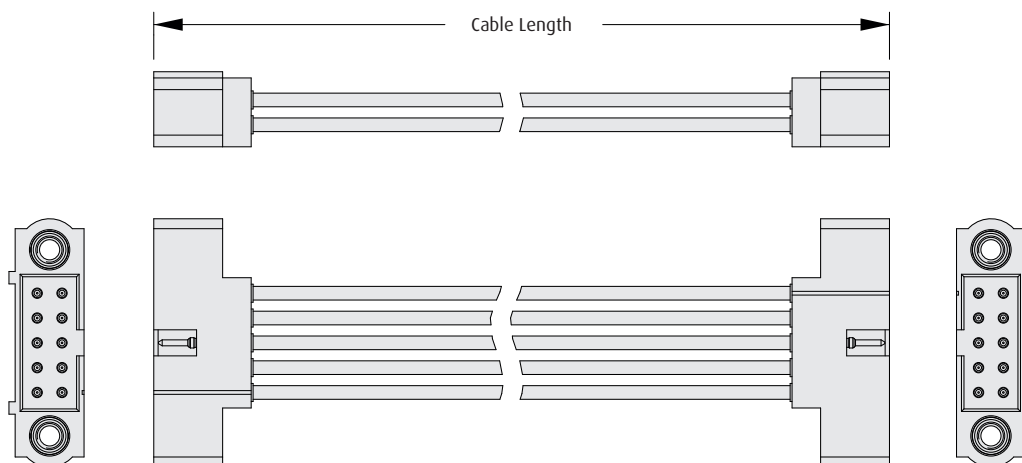

All dimensions in mm.

# Datamate J-Tek Connectors

## Male Metal Backshell

- ❖ Supplied as an accessory, to be used with existing male connectors.
- ❖ Can be fitted to either male vertical PCB connectors with board mount, or male cable connectors with panel mount jackscrews.
- ❖ Gives 360 degree shielding when mounted to a conductive panel and mated to a compatible female connector with metal backshell.



DATAMATE J-TEK

MALE		CALCULATION	
<b>A</b>	$B + 13.7$	<b>B</b>	Equivalent no. of contacts - 2
<b>C</b>	$B + 7$	<b>D</b>	$B + 2.8$

### HOW TO ORDER

**M80 - 906 XX 02**

<b>SERIES CODE</b>	<b>FINISH</b>
	<b>02</b> Nickel

<b>EQUIVALENT NO. OF SIGNAL CONTACTS</b>
<b>08 to 28, 32 to 50 (Even numbers only)</b>

All dimensions in mm.

# Datamate J-Tek Connectors

DATAMATE J-TEK

## Flexible Circuit Assemblies

- ❖ Surface mount connectors with jackscrews, assembled to flexible printed circuit for an alternative to cable connection.
- ❖ Improved bend radius and lower mated height than equivalent cable assemblies.
- ❖ The free end of the single-ended assembly is compatible with 1mm pitch FPC connectors.
- ❖ Contact Harwin for alternative connector sizes and cable lengths.

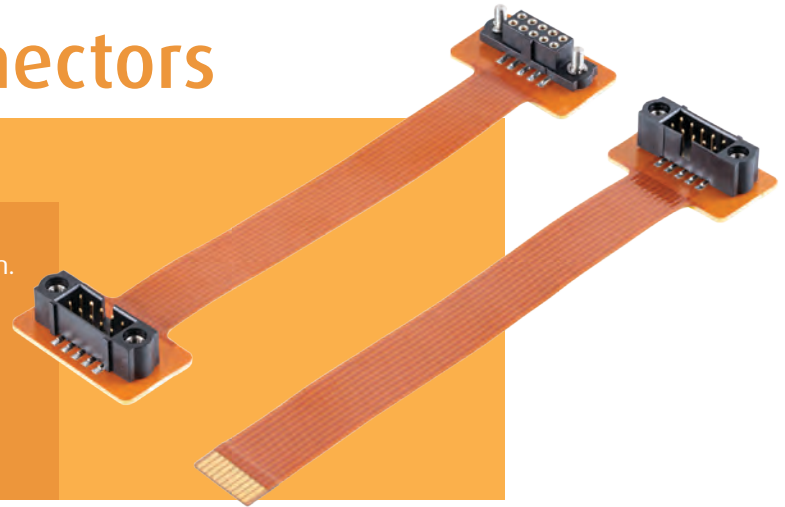

### MALE SINGLE ENDED

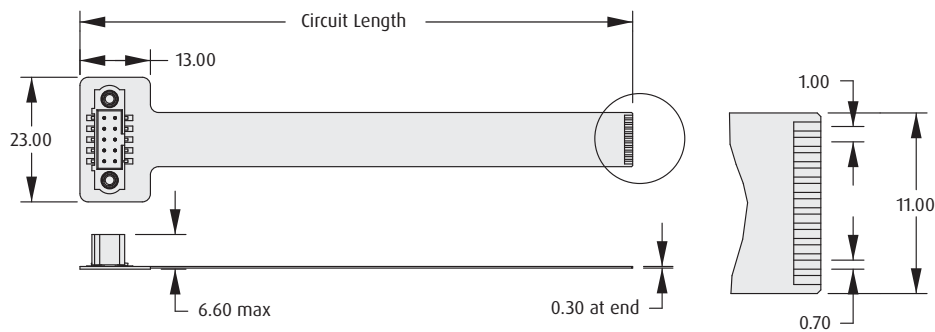

### MALE - FEMALE DOUBLE ENDED

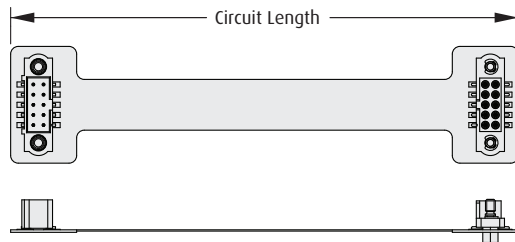

### HOW TO ORDER

**M80 - F1 502 10 - 100 - XXX**

<b>SERIES CODE</b>	M80	<b>CONNECTOR - FIRST END</b>	F1	<b>TOTAL NO. OF CONTACTS</b>	10	<b>CONNECTOR - SECOND END</b>	L	Free End (Single Ended)
		502	Male with internal jackscrews			402	Female with Hex Slotted Jackscrews	
						<b>CIRCUIT LENGTH</b>	100	100mm

All dimensions in mm.

# Datamate J-Tek 3-Row Specification

## Materials

Housings:	Glass-filled thermoplastic UL94V-0
Female contacts:	Brass shell, with Beryllium Copper inner contact
Male contacts:	Phosphor bronze
Finish:	Gold

## Electrical

<b>Current</b>	
Individual contacts in isolation:	3.3A max (at 25°C) 2.6A max (at 85°C)
All contacts simultaneously:	3.0A max (at 25°C) 2.2A max (at 85°C)
<b>Working voltage</b>	
At sea level 1013 mbar:	800V DC or AC <sub>rms</sub>
<b>Voltage proof</b>	
At sea level 1013 mbar:	1,200V DC or AC <sub>rms</sub>
<b>Contact resistance</b>	
Initial:	20mΩ max
After conditioning:	25mΩ max
<b>Insulation resistance</b>	
Initial:	1000MΩ min
After conditioning:	100MΩ min

## Mechanical

Durability:	500 operations
Insertion force (max):	1.0N
Withdrawal force (min):	0.2N
Signal crimp accommodation:	22 AWG to 28 AWG BS 3G 210 Type A or MIL-DTL-16878/6 Type ET

## Environmental

Environmental classification:	55/125/56 days at 95% RH
Operational temperature:	-55°C to +125°C
*Vibration sensitivity:	10Hz to 2000Hz, 0.75mm, 98m/s <sup>2</sup> (10G), duration 6h
*Bump severity:	390m/s <sup>2</sup> (40G), 4000 ±10 bumps
*Shock severity:	981m/s <sup>2</sup> (100G) for 6ms
*Acceleration severity:	490m/s <sup>2</sup> (50G)

\* Tested with connectors with Jackscrews.

## Pin Numbering

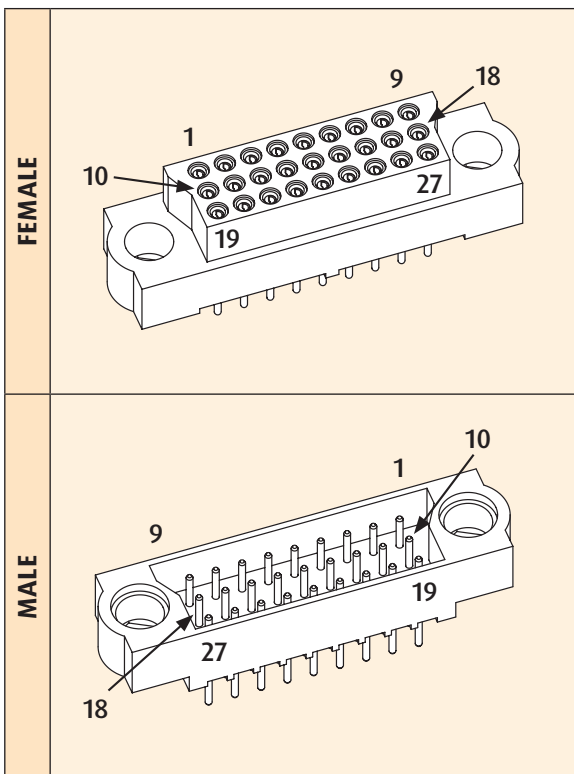

## Mating Profiles

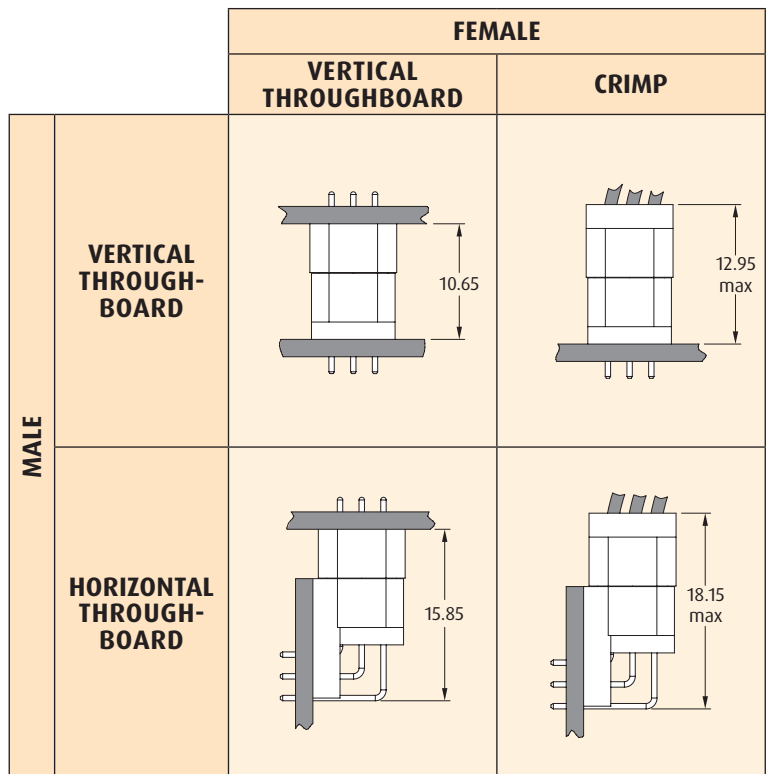

All dimensions in mm.

# Datamate J-Tek 3-Row Connectors

## Female Vertical Throughboard

- ❖ Low-force 4-finger Beryllium Copper contact clip.
- ❖ Fully shrouded contacts.
- ❖ Polarized housings.
- ❖ All contacts are gold finish for full RoHS compliance.
- ❖ Mates with all Datamate 3-Row male connectors with compatible jackscrews.

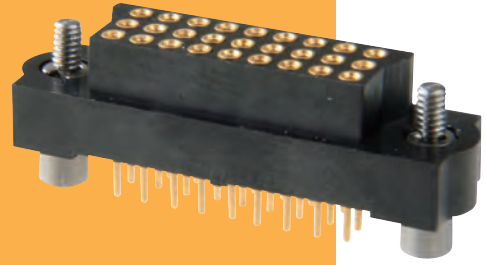

DATAMATE J-TEK 3-ROW

### THROUGHBOARD

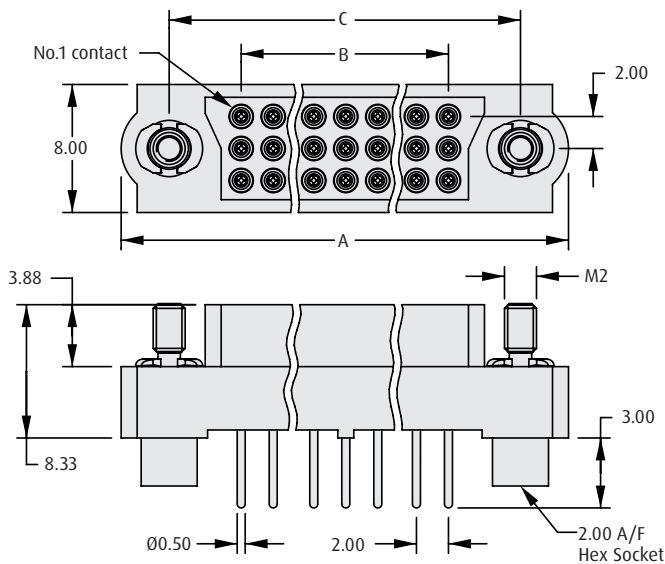

### CALCULATION

<b>A</b>	$B + 15$
<b>B</b>	$(\text{Total no. of contacts} - 3) \times 2/3$
<b>C</b>	$B + 9$

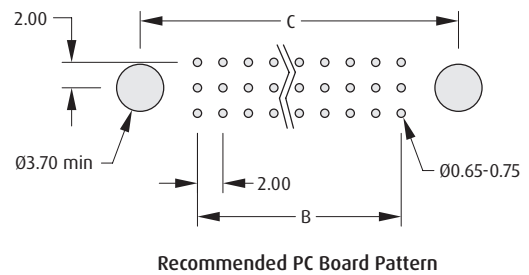

### HOW TO ORDER

**M83 - LF T1 F2 N XX - 0000 - 000**

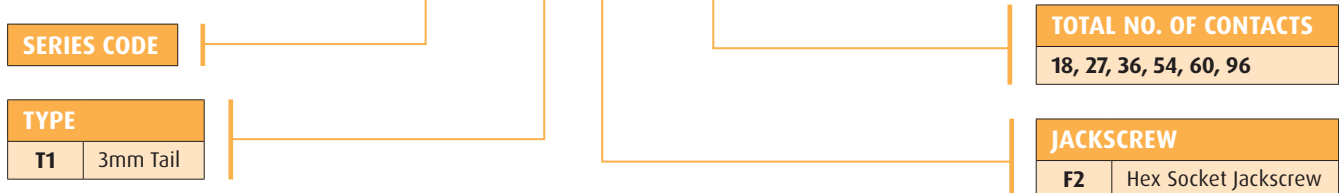

All dimensions in mm.



# Datamate J-Tek 3-Row Connectors

DATAMATE J-TEK 3-ROW

## Female Crimp Kit

- Part numbers are for a complete kit of a housing and the applicable number of contacts.
- Jackscrows are assembled where specified.
- Crimp contacts are rear insertable.
- Low-force 4-finger Beryllium Copper contact clip.
- Spare contacts are available.

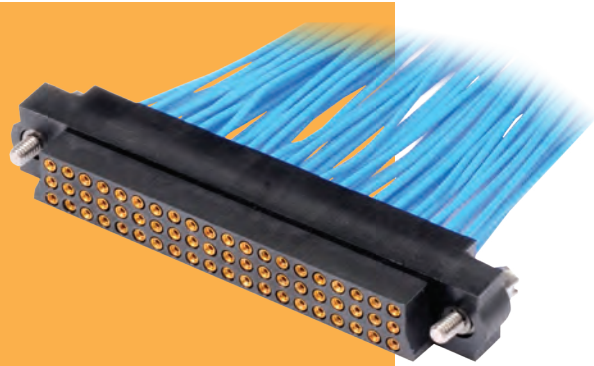

### FEMALE CRIMP

### CALCULATION

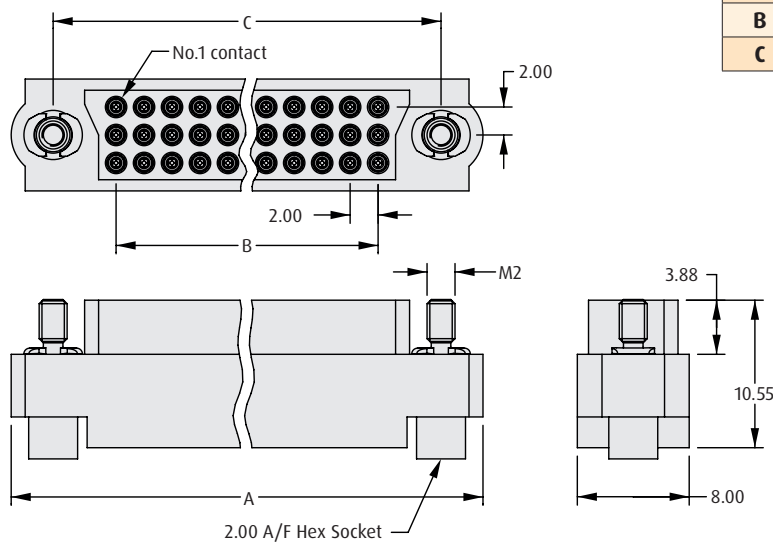

<b>A</b>	B + 15
<b>B</b>	(Total no. of contacts - 3) x 2/3
<b>C</b>	B + 9

### TOOLS

**Recommended Crimp Tool** - M22520/2-01  
**Positioner** - T5747  
**Contact Insertion/Removal Tool** - Z80-280

- Spare contacts shown on following pages.
- Instruction sheets available at [www.harwin.com/instructions](http://www.harwin.com/instructions).

### WIRE STRIPPING DETAILS

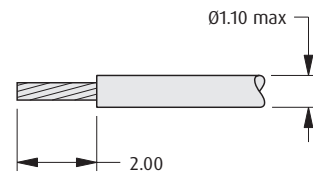

### HOW TO ORDER

**M83 - LF X1 F2 N XX - 0000 - 000**

**SERIES CODE**

**TYPE**

<b>C1</b>	Small Bore (24-28 AWG)
<b>D1</b>	Large Bore (22 AWG)

**TOTAL NO. OF CONTACTS**

18, 27, 36, 54, 60, 96

**JACKSCREW**

**F2** Hex Socket Jackscrew

All dimensions in mm.

# Datamate J-Tek 3-Row Connectors

## Spare Female Crimp Contacts

- Barrel Crimp Contacts are supplied with the connectors - see previous page. Use the order code for extra spare crimps.



DATAMATE J-TEK 3-ROW

CRIMP CONTACTS	WIRE STRIPPING DETAILS						
<p><b>Large Bore (22 AWG)</b></p> <p>7.45</p> <p>2 x Ident Grooves</p> <p><b>Small Bore (24 to 28 AWG)</b></p> <p>3 x Ident Grooves</p>	<p>Ø1.10 max</p> <p>2.00</p>						
	TOOLS						
	<p><b>Recommended Crimp Tool</b> - M22520/2-01</p> <p><b>Positioner</b> - T5747</p> <p><b>Contact Insertion/Removal Tool</b> - Z80-280</p> <p>❖ Instruction sheets available at <a href="http://www.harwin.com/instructions">www.harwin.com/instructions</a>.</p>						
HOW TO ORDER							
<p><b>M83 - 01X 00 05</b></p>							
<p><b>SERIES CODE</b></p>							
<table border="1"> <thead> <tr> <th colspan="2">TYPE</th> </tr> </thead> <tbody> <tr> <td><b>011</b></td> <td>Large Bore (22 AWG)</td> </tr> <tr> <td><b>013</b></td> <td>Small Bore (24-28 AWG)</td> </tr> </tbody> </table>	TYPE		<b>011</b>	Large Bore (22 AWG)	<b>013</b>	Small Bore (24-28 AWG)	
TYPE							
<b>011</b>	Large Bore (22 AWG)						
<b>013</b>	Small Bore (24-28 AWG)						
	<table border="1"> <thead> <tr> <th colspan="2">FINISH</th> </tr> </thead> <tbody> <tr> <td><b>05</b></td> <td>Gold</td> </tr> </tbody> </table>	FINISH		<b>05</b>	Gold		
FINISH							
<b>05</b>	Gold						

All dimensions in mm.

# Datamate J-Tek 3-Row Connectors

DATAMATE J-TEK 3-RW

## Male Vertical Throughboard

- Board Mount nuts to be tightened to a maximum torque of 23cmN.
- Fully shrouded contacts.
- Polarized housings.
- All contacts are gold finish for full RoHS compliance.
- Mates with all Datamate 3-Row female connectors with compatible jackscrews.

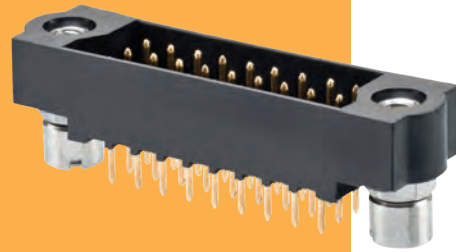

### MALE VERTICAL

### CALCULATION

<b>A</b>	B + 15
<b>B</b>	(Total no. of contacts - 3) x 2/3
<b>C</b>	B + 9

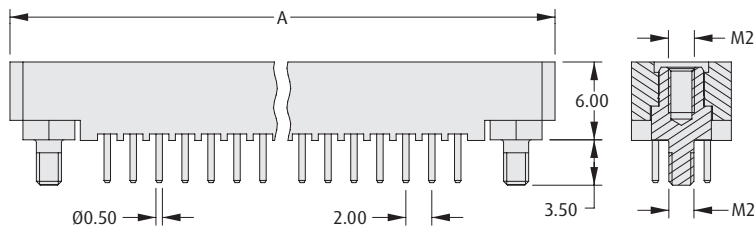
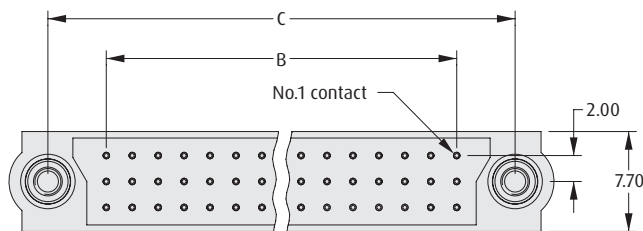

### Board Mount Nut, 2 per connector

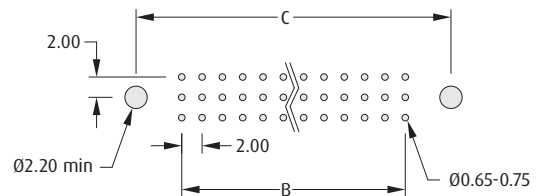
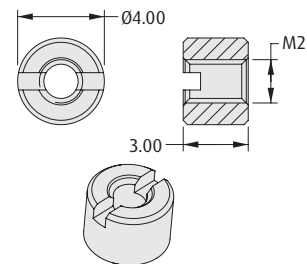

Recommended PC Board Pattern

### HOW TO ORDER

**M83 - LM T1 M2 N XX - 0000 - 000**

**SERIES CODE**

M83 - LM

**TYPE**

**T1** 3mm Tail

T1

M2

N

XX

- 0000 - 000

**TOTAL NO. OF CONTACTS**

18, 27, 36, 54, 60, 96

**JACKSCREW**

**M2** Board Mount Jackscrew

All dimensions in mm.

# Datamate J-Tek 3-Row Connectors

## Male Horizontal Throughboard

- Board Mount jackscrews provide PCB strain relief. Hex socket bolts are included, and are supplied loose - tighten to a maximum torque of 23cmN.
- Suitable for motherboard/daughterboard configurations.
- Fully shrouded contacts, polarized housings.
- All contacts are gold finish for full RoHS compliance.
- Mates with all Datamate 3-Row female connectors with compatible standard gender jackscrews.

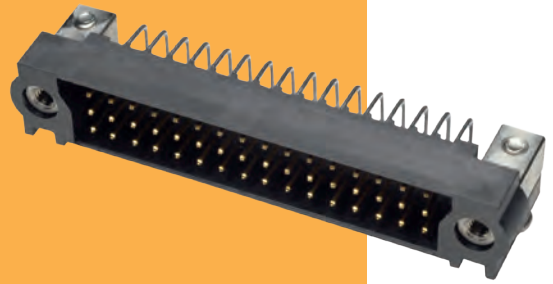

DATAMATE J-TEK 3-ROW

### MALE HORIZONTAL

### CALCULATION

<b>A</b>	B + 15
<b>B</b>	(Total no. of contacts - 3) x 2/3
<b>C</b>	B + 9

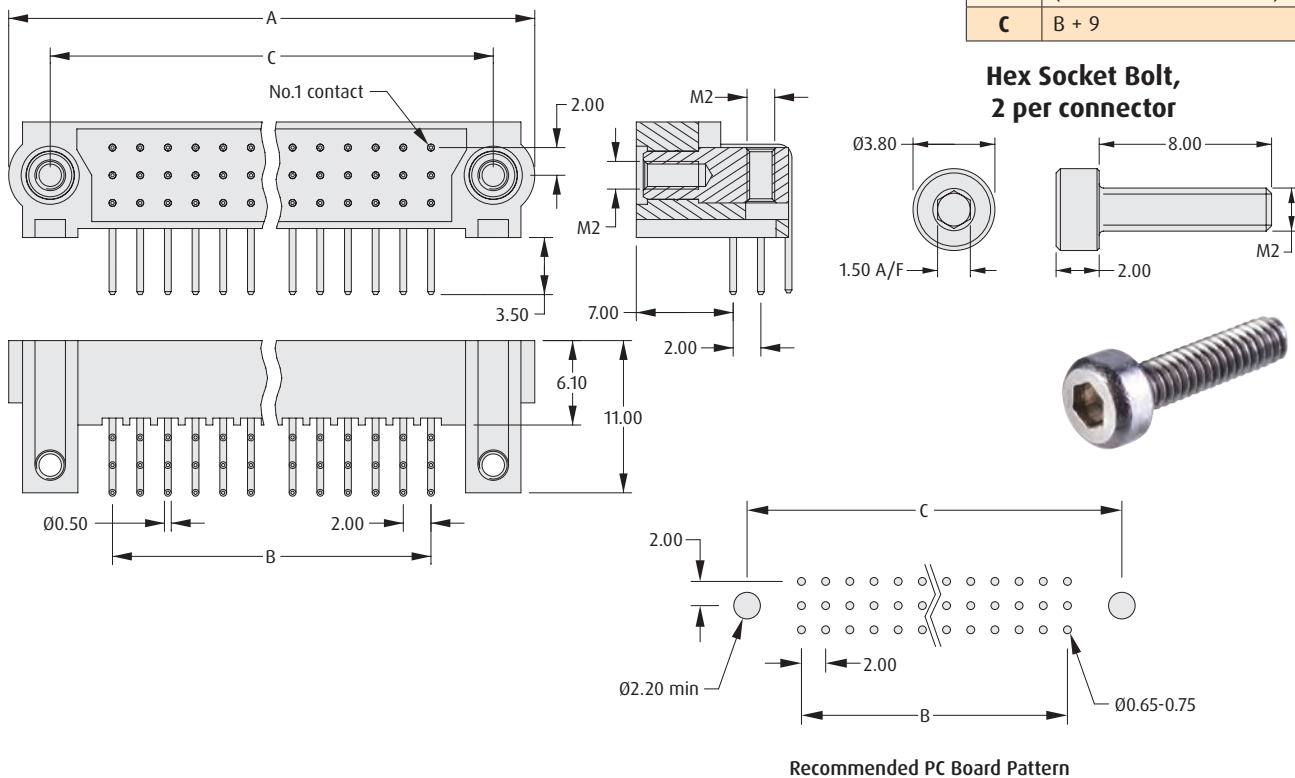

### HOW TO ORDER

**M83 - LM L3 M7 N XX - 0000 - 000**

**SERIES CODE**

**TOTAL NO. OF CONTACTS**

18, 27, 36, 54, 60, 96

**TYPE**

**L3** 3.5mm Tails

**JACKSCREW**

**M7** Hex Socket Board Mount

All dimensions in mm.

# Datamate L-Tek Specification

## Materials

Housings:	Glass-filled thermoplastic UL94V-0
Female contacts:	Brass shell, with Beryllium Copper inner contact
Male contacts:	Copper alloy
Finish:	See individual pages

## Mechanical

Durability:	500 operations
Insertion force (max):	2.8N
Withdrawal force (min):	0.2N
Signal crimp accommodation:	22 AWG to 32 AWG BS 3G 210 Type A, MIL-W-16878

## Electrical

<b>Current</b>	
Individual contacts in isolation:	3.3A max (at 25°C) 2.6A max (at 85°C)
All contacts simultaneously:	3.0A max (at 25°C) 2.2A max (at 85°C)
<b>Working voltage</b>	
At sea level 1013 mbar:	800V DC or AC <sub>rms</sub>
<b>Voltage proof</b>	
At sea level 1013 mbar:	1,200V DC or AC <sub>rms</sub>
<b>Contact resistance</b>	
Initial:	20mΩ max
After conditioning:	25mΩ max
<b>Insulation resistance</b>	
Initial:	1,000MΩ min
After conditioning:	100MΩ min

## Environmental

Environmental classification:	55/125/56 days at 95% RH
Operational temperature:	-55°C to +125°C
*Vibration sensitivity:	10Hz to 2000Hz, 0.75mm, 98m/s <sup>2</sup> (10G), duration 6h
*Bump severity:	390m/s <sup>2</sup> (40G), 4000 ±10 bumps
*Shock severity:	981m/s <sup>2</sup> (100G) for 6ms
*Acceleration severity:	490m/s <sup>2</sup> (50G)

\* Tested with latched connectors.

# Pin Numbering

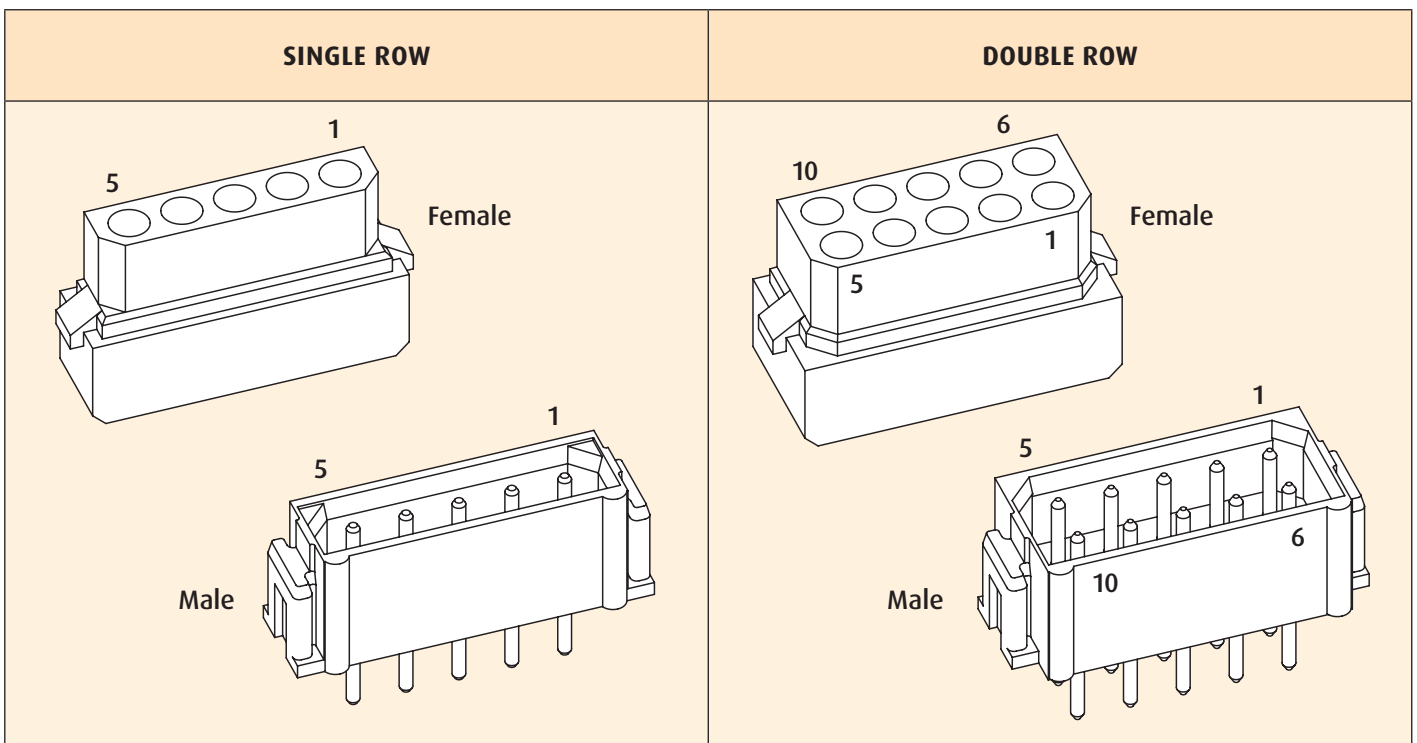

All dimensions in mm.

# Datamate L-Tek Mating Profiles

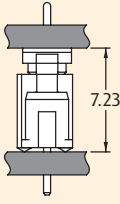
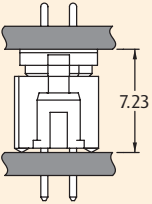
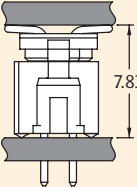
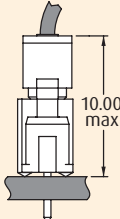
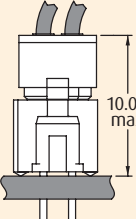
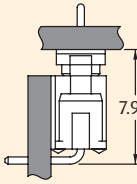
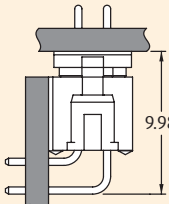
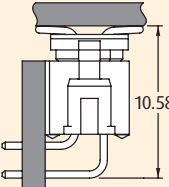
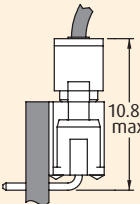
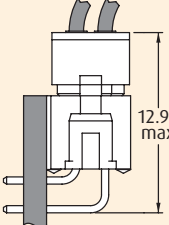
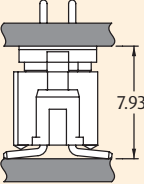
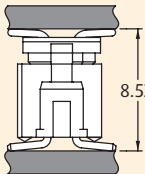
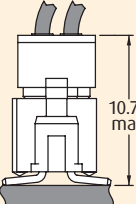
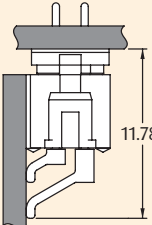
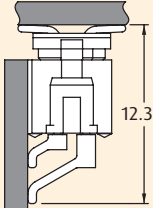
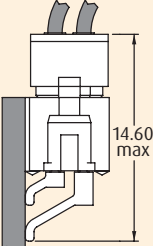
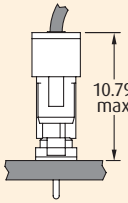
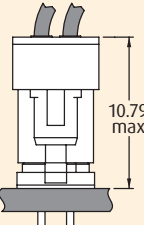
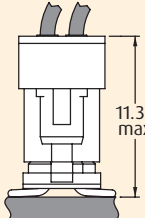
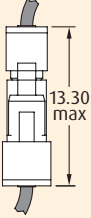
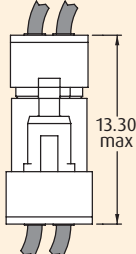
		FEMALE				
		VERTICAL THROUGHBOARD		VERTICAL SMT	CRIMP	
		SIL	DIL	DIL	SIL	DIL
MALE	VERTICAL THROUGHBOARD	 7.23	 7.23	 7.83	 10.00 max	 10.00 max
	HORIZONTAL THROUGHBOARD	 7.98	 9.98	 10.58	 10.85 max	 12.95 max
	VERTICAL SMT		 7.93	 8.53		 10.75 max
	HORIZONTAL SMT		 11.78	 12.38		 14.60 max
	CRIMP	 10.79 max	 10.79 max	 11.39 max	 13.30 max	 13.30 max

All dimensions in mm.

# Datamate L-Tek Connectors

DATAMATE L-TEK

## Female Vertical Throughboard

- Polarized housings.
- Dummy contacts are available for additional polarization, use **order code M80-023**.

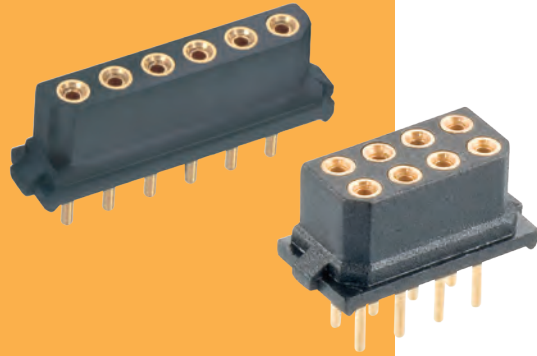

### SINGLE ROW

#### CALCULATION

<b>A</b>	$B + 5.15$
<b>B</b>	$(\text{Total no. of contacts} - 1) \times 2$

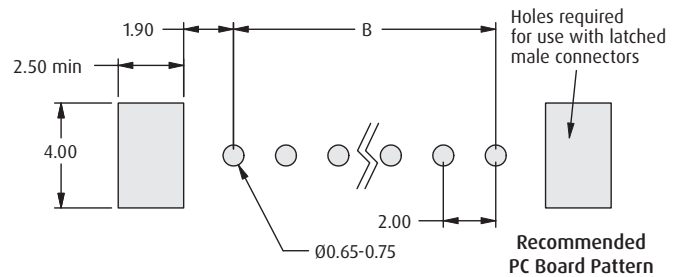
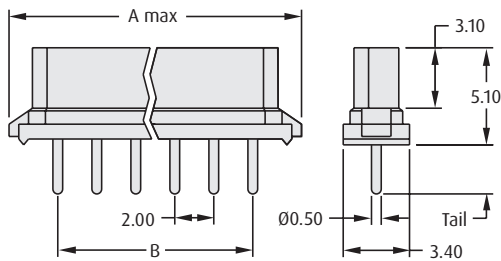

### DOUBLE ROW

#### CALCULATION

<b>A</b>	$B + 5.15$
<b>B</b>	$\text{Total no. of contacts} - 2$

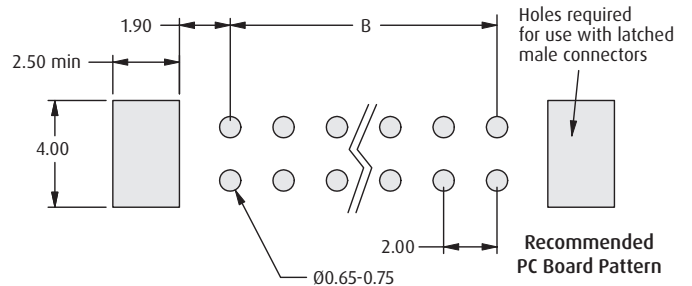
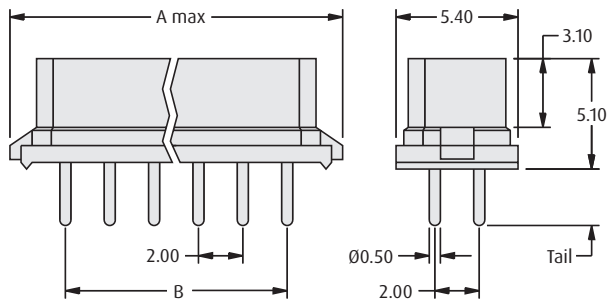

### HOW TO ORDER

**M80 - XXX XX XX**

#### SERIES CODE

#### TYPE

<b>840</b>	Single Row (3mm tail)
<b>850</b>	Double Row (3mm tail)
<b>790</b>	Single Row (4.5mm tail)
<b>770</b>	Double Row (4.5mm tail)

#### FINISH

<b>42</b>	Gold + Tin
<b>45</b>	Gold

#### TOTAL NO. OF CONTACTS

<b>02 to 07, 17, 22</b>	Single Row
<b>04, 06, 08, 10, 12, 14, 16, 18, 20, 26, 34, 44</b>	Double Row

All dimensions in mm.

# Datamate L-Tek Connectors

## Female Vertical Surface Mount

- ❖ Optional pick and place cap.
- ❖ Gull wing SMT tails simplify inspection process.

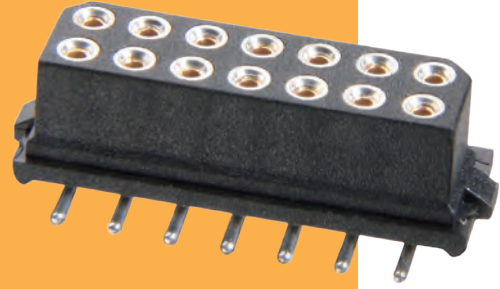

### DOUBLE ROW

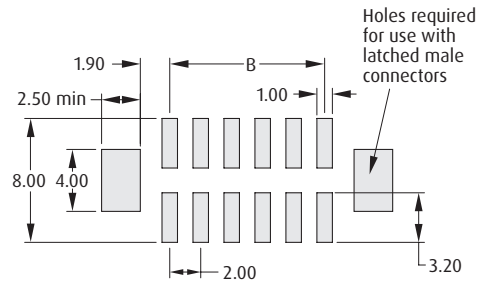
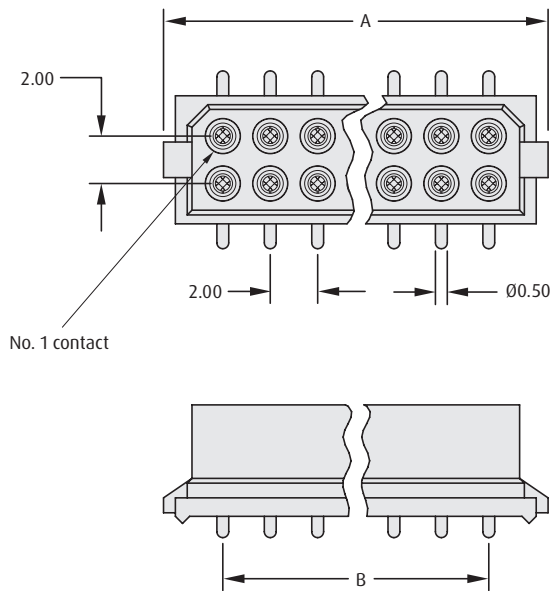

Recommended PC Board Pattern

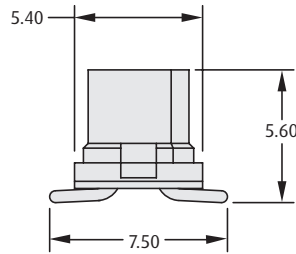

### CALCULATION

<b>A</b>	$B + 5.15$
<b>B</b>	Total no. of contacts - 2

### HOW TO ORDER

**M80 - 681 XX XX P**

SERIES CODE

TOTAL NO. OF CONTACTS

04, 06, 08, 10, 12, 14, 16, 18, 20, 26, 34, 44

### PICK AND PLACE CAP

<b>BLANK</b>	No cap
<b>P</b>	Pick and place cap

### FINISH

<b>42</b>	Gold + Tin
<b>45</b>	Gold

All dimensions in mm.



# Datamate L-Tek Connectors

## Female Crimp Kit

- Part numbers are for a complete kit of a housing and the applicable number of contacts.
- Contacts are rear insertable.
- Spare contacts are available – see the following page.



SINGLE ROW	CALCULATION	DOUBLE ROW	CALCULATION
	<b>A</b> B + 5.15		<b>A</b> B + 5.15
	<b>B</b> (Total no. of contacts - 1) x 2		<b>B</b> Total no. of contacts - 2

TOOLS	WIRE STRIPPING DETAILS
<p><b>Recommended Crimp Tool</b> - M22520/2-01</p> <p><b>Positioner</b> - T5747</p> <p><b>Contact Insertion/Removal Tool</b> - Z80-280</p> <ul style="list-style-type: none"> <li>Spare and pre-cabled contacts shown on following pages.</li> <li>Instruction sheets available at <a href="http://www.harwin.com/instructions">www.harwin.com/instructions</a>.</li> </ul>	

### HOW TO ORDER

**M80 - XXX XX XX**

**SERIES CODE**

TYPE	
<b>798</b>	Single Row, Extra Small Bore (28-32 AWG)
<b>898</b>	Single Row, Small Bore (24-28 AWG)
<b>899</b>	Single Row, Large Bore (22 AWG)
<b>788</b>	Double Row, Extra Small Bore (28-32 AWG)
<b>888</b>	Double Row, Small Bore (24-28 AWG)
<b>889</b>	Double Row, Large Bore (22 AWG)

FINISH	
<b>01</b>	Gold + Tin
<b>05</b>	Gold

TOTAL NO. OF CONTACTS	
<b>02 to 07, 17</b>	Single Row
<b>04, 06, 08, 10, 12, 14, 16, 18, 20, 26, 34</b>	Double Row

All dimensions in mm.

# Datamate L-Tek Connectors

## Spare Female Crimp Contacts

- Barrel Crimp Contacts are supplied with the connectors - see previous page. Use the order code for extra spare crimps.



DATAMATE L-TEK

CRIMP CONTACTS	DUMMY CONTACT												
<p><b>Large Bore (22 AWG)</b></p> <p><b>Small Bore (24 to 28 AWG)</b></p> <p><b>Extra Small Bore (28 to 32 AWG)</b></p>	<div style="border: 1px solid black; padding: 2px; width: fit-content; margin-top: 10px;"> <b>ORDER CODE</b>  <b>M80-023</b> </div>												
	WIRE STRIPPING DETAILS												
	TOOLS												
	<p><b>Recommended Crimp Tool</b> - M22520/2-01  <b>Positioner</b> - T5747  <b>Contact Insertion/Removal Tool</b> - Z80-280</p> <ul style="list-style-type: none"> <li>Pre-cabled contacts shown on following page.</li> <li>Instruction sheets available at <a href="http://www.harwin.com/instructions">www.harwin.com/instructions</a>.</li> </ul>												
HOW TO ORDER													
<p><b>M80 - 0XX 00 XX</b></p>													
<div style="border: 1px solid black; padding: 5px; width: fit-content; margin-bottom: 10px;"> <b>SERIES CODE</b> </div> <table border="1" style="width: 100%; border-collapse: collapse;"> <thead> <tr> <th colspan="2" style="background-color: #f4a460;">TYPE</th> </tr> </thead> <tbody> <tr> <td style="text-align: center;"><b>011</b></td> <td>Large Bore (22 AWG)</td> </tr> <tr> <td style="text-align: center;"><b>013</b></td> <td>Small Bore (24-28 AWG)</td> </tr> <tr> <td style="text-align: center;"><b>019</b></td> <td>Extra Small Bore (28-32 AWG)</td> </tr> </tbody> </table>	TYPE		<b>011</b>	Large Bore (22 AWG)	<b>013</b>	Small Bore (24-28 AWG)	<b>019</b>	Extra Small Bore (28-32 AWG)	<div style="border: 1px solid black; padding: 5px; width: fit-content; margin-top: 10px;"> <b>FINISH</b> </div> <table border="1" style="width: 100%; border-collapse: collapse;"> <tbody> <tr> <td style="text-align: center;"><b>01</b></td> <td>Gold + Tin</td> </tr> <tr> <td style="text-align: center;"><b>05</b></td> <td>Gold</td> </tr> </tbody> </table>	<b>01</b>	Gold + Tin	<b>05</b>	Gold
TYPE													
<b>011</b>	Large Bore (22 AWG)												
<b>013</b>	Small Bore (24-28 AWG)												
<b>019</b>	Extra Small Bore (28-32 AWG)												
<b>01</b>	Gold + Tin												
<b>05</b>	Gold												

All dimensions in mm.

# Datamate L-Tek Connectors

## Female Crimp Contacts – Pre-Crimped Wires

- Female crimp contacts pre-assembled with a choice of BS 3G 210 Type A cable at selected lengths.
- PTFE-insulated, multi-strand silver-plated copper conductor equipment wire.
- Ideal for prototype and pre-production applications.

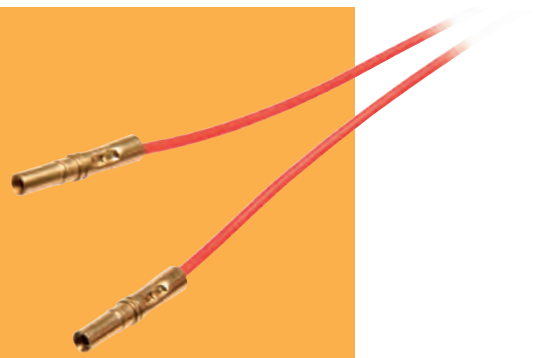

FEMALE SINGLE ENDED	FEMALE - FEMALE

### TOOLS

**Contact Insertion/Removal Tool** – Z80-280

- Full crimp connector kits and spare crimp contacts shown on previous pages.
- Instruction sheets available at [www.harwin.com/instructions](http://www.harwin.com/instructions).

### HOW TO ORDER

**M80 - 9XX 00 99**

SERIES CODE

CABLE COLOR

99 Red

SINGLE ENDED	FEMALE-FEMALE	
910	918	22 AWG Cable, 150mm length
911	919	24 AWG Cable, 150mm length
912	920	26 AWG Cable, 150mm length
913	921	28 AWG Cable, 150mm length
914	922	22 AWG Cable, 300mm length
915	923	24 AWG Cable, 300mm length
916	924	26 AWG Cable, 300mm length
917	925	28 AWG Cable, 300mm length

All dimensions in mm.

# Datamate L-Tek Connectors

## Female Cable Assemblies

- Ready-made cable assemblies, fully tested and inspected.
- Constructed with Contact 1 to Contact 1, Contact 2 to Contact 2, etc.
- Double Row connectors (10 contacts and larger) compatible with plastic Hood shown on following page.
- For multicolor sequence, check applicable Technical Drawing.

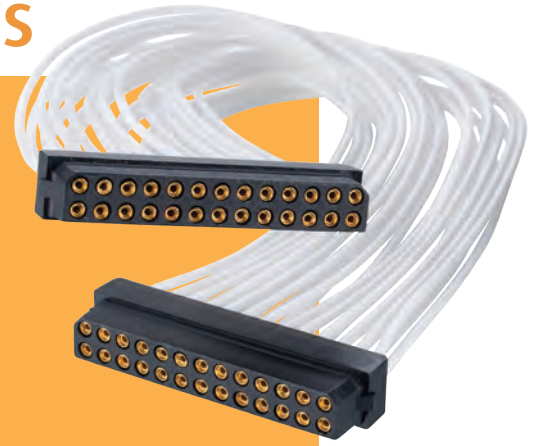

DATAMATE L-TEK

SINGLE ROW, SINGLE ENDED	DOUBLE ROW, SINGLE ENDED																		
FEMALE - FEMALE DOUBLE ENDED																			
HOW TO ORDER																			
<b>M80 - FX X XX XX LO - XXXX X</b>																			
<table border="1" style="width: 100%; border-collapse: collapse;"> <thead> <tr style="background-color: #f4a460; color: white;"> <th colspan="2">SERIES CODE</th> </tr> </thead> <tbody> <tr> <td style="width: 150px;"><b>M80-FD</b></td> <td>Single Row</td> </tr> <tr> <td><b>M80-FC</b></td> <td>Double Row</td> </tr> </tbody> </table>	SERIES CODE		<b>M80-FD</b>	Single Row	<b>M80-FC</b>	Double Row	<table border="1" style="width: 100%; border-collapse: collapse;"> <thead> <tr style="background-color: #f4a460; color: white;"> <th colspan="2">TERMINATION - SECOND END</th> </tr> </thead> <tbody> <tr> <td style="width: 150px;"><b>L</b></td> <td>Loose cut end</td> </tr> <tr> <td><b>F</b></td> <td>Female connector</td> </tr> </tbody> </table>	TERMINATION - SECOND END		<b>L</b>	Loose cut end	<b>F</b>	Female connector						
SERIES CODE																			
<b>M80-FD</b>	Single Row																		
<b>M80-FC</b>	Double Row																		
TERMINATION - SECOND END																			
<b>L</b>	Loose cut end																		
<b>F</b>	Female connector																		
<table border="1" style="width: 100%; border-collapse: collapse;"> <thead> <tr style="background-color: #f4a460; color: white;"> <th colspan="2">CABLE SIZE</th> </tr> </thead> <tbody> <tr> <td style="width: 150px;"><b>1</b></td> <td>22 AWG</td> </tr> <tr> <td><b>2</b></td> <td>24 AWG</td> </tr> <tr> <td><b>3</b></td> <td>26 AWG</td> </tr> <tr> <td><b>4</b></td> <td>28 AWG</td> </tr> <tr> <td><b>5</b></td> <td>30 AWG</td> </tr> </tbody> </table>	CABLE SIZE		<b>1</b>	22 AWG	<b>2</b>	24 AWG	<b>3</b>	26 AWG	<b>4</b>	28 AWG	<b>5</b>	30 AWG	<table border="1" style="width: 100%; border-collapse: collapse;"> <thead> <tr style="background-color: #f4a460; color: white;"> <th colspan="2">CABLE LENGTH</th> </tr> </thead> <tbody> <tr> <td style="width: 150px;"><b>0150</b></td> <td>150mm</td> </tr> <tr> <td><b>XXXX</b></td> <td>XXXXmm</td> </tr> </tbody> </table>	CABLE LENGTH		<b>0150</b>	150mm	<b>XXXX</b>	XXXXmm
CABLE SIZE																			
<b>1</b>	22 AWG																		
<b>2</b>	24 AWG																		
<b>3</b>	26 AWG																		
<b>4</b>	28 AWG																		
<b>5</b>	30 AWG																		
CABLE LENGTH																			
<b>0150</b>	150mm																		
<b>XXXX</b>	XXXXmm																		
<table border="1" style="width: 100%; border-collapse: collapse;"> <thead> <tr style="background-color: #f4a460; color: white;"> <th colspan="2">TOTAL NO. OF CONTACTS</th> </tr> </thead> <tbody> <tr> <td style="width: 150px;"><b>02 to 07, 17</b></td> <td>Single Row</td> </tr> <tr> <td><b>04, 06, 08, 10, 12, 14, 16, 18, 20, 26, 34</b></td> <td>Double Row</td> </tr> </tbody> </table>	TOTAL NO. OF CONTACTS		<b>02 to 07, 17</b>	Single Row	<b>04, 06, 08, 10, 12, 14, 16, 18, 20, 26, 34</b>	Double Row	<table border="1" style="width: 100%; border-collapse: collapse;"> <thead> <tr style="background-color: #f4a460; color: white;"> <th colspan="2">WIRE COLOR</th> </tr> </thead> <tbody> <tr> <td style="width: 150px;"><b>05</b></td> <td>White cable (double-ended)</td> </tr> <tr> <td><b>68</b></td> <td>Multicolor cable (single-ended)</td> </tr> </tbody> </table>	WIRE COLOR		<b>05</b>	White cable (double-ended)	<b>68</b>	Multicolor cable (single-ended)						
TOTAL NO. OF CONTACTS																			
<b>02 to 07, 17</b>	Single Row																		
<b>04, 06, 08, 10, 12, 14, 16, 18, 20, 26, 34</b>	Double Row																		
WIRE COLOR																			
<b>05</b>	White cable (double-ended)																		
<b>68</b>	Multicolor cable (single-ended)																		

All dimensions in mm.

# Datamate L-Tek Connectors

## Female Plastic Cable Hood

- ❖ Supplied as a kit of parts, including body, lid, cable clamp and 4 screws.
- ❖ For use with double row female crimp connectors.
- ❖ Mates with unlatched male connectors.



DATAMATE L-TEK

### CRIMP HOOD

### CALCULATION

<b>A</b>	$B + 8.3$
<b>B</b>	Total no. of contacts - 2
<b>C</b>	$B + 6.3$

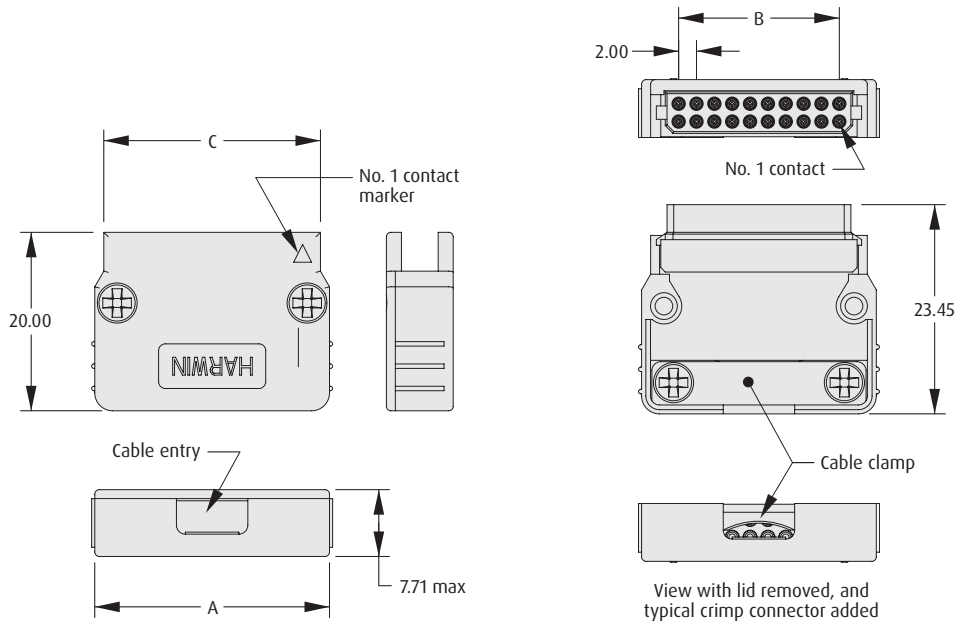

### HOW TO ORDER

**M80 - 880 XX 98**

SERIES CODE

TOTAL NO. OF CONTACTS

10, 12, 14, 16, 18, 20, 26, 34

All dimensions in mm.

# Datamate L-Tek Connectors

## Male Single Row Vertical Throughboard

- Polarized housings.
- Fully shrouded contacts.
- Mates with standard Datamate L-Tek female connectors.
- Can be used with optional Strain Relief straps, available to order separately: **order code M80-0030006**.

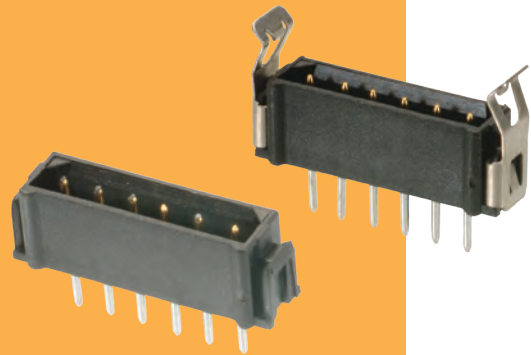

NO LATCHES	CALCULATION	LOCKING LATCH	CALCULATION
	<b>A</b> B + 5.6		<b>A</b> B + 6.1
	<b>B</b> (Total no. of contacts - 1) x 2		<b>B</b> (Total no. of contacts - 1) x 2

**STRAIN RELIEF STRAP** Order separately from connector

View of Strain Relief strap in place

**ORDER CODE**  
**M80-0030006**

**Recommended PC Board Pattern**

**HOW TO ORDER**

**M80 - XXX XX XX**

**SERIES CODE**

TYPE	
<b>852</b>	No Latches, 3mm Tail
<b>882</b>	Locking Latch, 3mm Tail
<b>782</b>	Locking Latch, 4.5mm Tail

**FINISH**

<b>42</b>	Gold + Tin
<b>45</b>	Gold

**TOTAL NO. OF CONTACTS**

**02 to 07**

All dimensions in mm.

# Datamate L-Tek Connectors

## Male Double Row Vertical Throughboard

- ❖ Polarized housings.
- ❖ Fully shrouded contacts.
- ❖ Mates with standard Datamate L-Tek female connectors.
- ❖ Can be used with optional Strain Relief straps, available to order separately: **order code M80-0030006**.

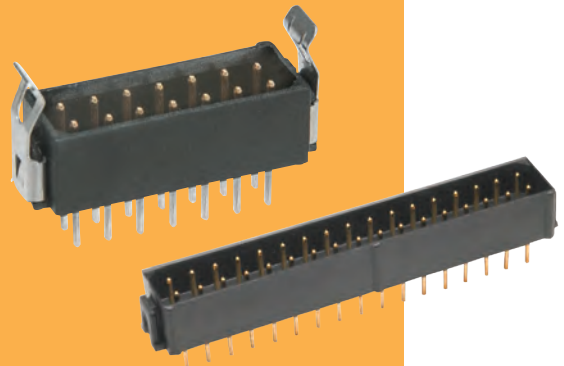

DATAMATE L-TEK

NO LATCHES	CALCULATION	LOCKING LATCH	CALCULATION
	<b>A</b> B + 5.6		<b>A</b> B + 6.1
	<b>B</b> Total no. of contacts - 2		<b>B</b> Total no. of contacts - 2

### STRAIN RELIEF STRAP

Order separately from connector

View of Strain Relief strap in place

**ORDER CODE**  
**M80-0030006**

### Recommended PC Board Pattern

### HOW TO ORDER

M80 - XXX XX XX

SERIES CODE			FINISH	
3mm TAIL	4.5mm TAIL			42
854	754	No Latches	45	Gold
853	753	Locking Latch		

**TOTAL NO. OF CONTACTS**  
 04, 06, 08, 10, 12, 14, 16, 18, 20, 26, 34, 44

All dimensions in mm.

# Datamate L-Tek Connectors

DATAMATE L-TEK

## Male Single Row Horizontal Throughboard

- Polarized housings.
- Fully shrouded contacts.
- Mates with standard Datamate L-Tek female connectors.
- Supplied with two Strain Relief straps per connector; spares available under **order code M80-0030006**.

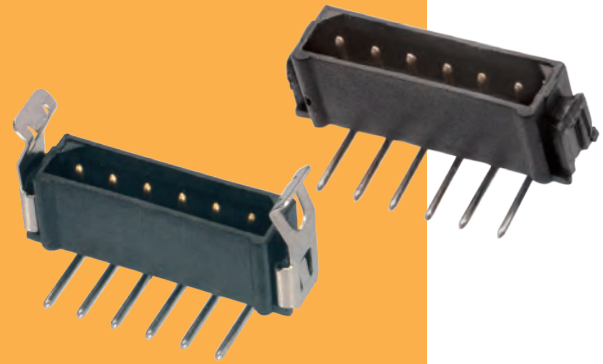

NO LATCHES	CALCULATION	LOCKING LATCH	CALCULATION
	<b>A</b> B + 5.6		<b>A</b> B + 6.1
	<b>B</b> (Total no. of contacts - 1) x 2		<b>B</b> (Total no. of contacts - 1) x 2

STRAIN RELIEF STRAP	Supplied with connector	Recommended PC Board Pattern
	<p>View of Strain Relief strap in place</p>	

### HOW TO ORDER

**M80 - XXX XX XX**

**SERIES CODE**

TYPE	
<b>843</b>	No Latches, 3mm Tail
<b>842</b>	Locking Latch, 3mm Tail
<b>792</b>	Locking Latch, 4.5mm Tail

**FINISH**

<b>42</b>	Gold + Tin
<b>45</b>	Gold

**TOTAL NO. OF CONTACTS**

**02 to 07**

All dimensions in mm.



# Datamate L-Tek Connectors

## Male Double Row Horizontal Throughboard

- ❖ Polarized housings.
- ❖ Fully shrouded contacts.
- ❖ Mates with standard Datamate L-Tek female connectors.
- ❖ Supplied with two Strain Relief straps per connector; spares available under **order code M80-0030006**.

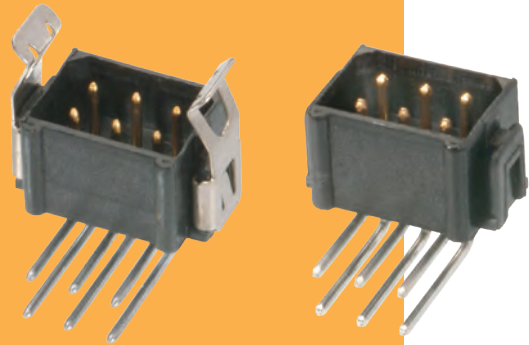

DATAMATE L-TEK

NO LATCHES	CALCULATION	LOCKING LATCH	CALCULATION
	<b>A</b> B + 5.6		<b>A</b> B + 6.1
	<b>B</b> Total no. of contacts - 2		<b>B</b> Total no. of contacts - 2

STRAIN RELIEF STRAP	Supplied with connector	Recommended PC Board Pattern

### HOW TO ORDER

**M80 - XXX XX XX**

**SERIES CODE**

TYPE	
<b>841</b>	No Latches, 3mm Tail
<b>851</b>	Locking Latch, 3mm Tail
<b>771</b>	Locking Latch, 4.5mm Tail

**FINISH**

<b>42</b>	Gold + Tin
<b>45</b>	Gold

**TOTAL NO. OF CONTACTS**

**04, 06, 08, 10, 12, 14, 16, 18, 20, 26, 34, 44**

All dimensions in mm.

# Datamate L-Tek Connectors

## Male Vertical Surface Mount

- Mates with standard Datamate L-Tek female connectors.
- Can be used with optional Strain Relief straps, available to order separately: **order code M80-0030006**.
- Optional pick and place cap.
- Gull wing SMT tails simplify inspection process.

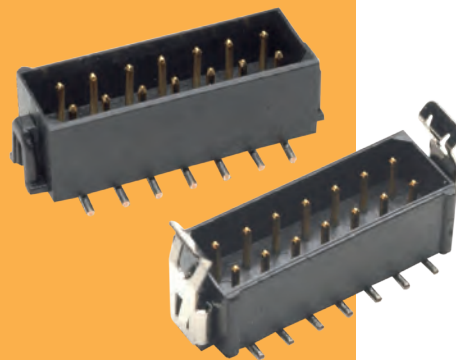

NO LATCHES	CALCULATION	LOCKING LATCH	CALCULATION
	<b>A</b> B + 5.6		<b>A</b> B + 6.1
	<b>B</b> Total no. of contacts - 2		<b>B</b> Total no. of contacts - 2

### STRAIN RELIEF STRAP

Order separately from connector

View of Strain Relief strap in place

ORDER CODE

M80-0030006

### Recommended PC Board Pattern

## HOW TO ORDER

M80 - 82X XX XX P

<b>SERIES CODE</b>		<b>PICK AND PLACE CAP</b>	
<b>TYPE</b>		<b>BLANK</b>	No cap
826	No Latches	<b>P</b>	Pick and place cap
828	Locking Latch		
	<b>TOTAL NO. OF CONTACTS</b>	<b>FINISH</b>	
	04, 06, 08, 10, 12, 14, 16, 18, 20, 26, 34	42	Gold + Tin
		45	Gold

All dimensions in mm.

# Datamate L-Tek Connectors

## Male Horizontal Surface Mount

- ❖ Mates with standard Datamate L-Tek female connectors.
- ❖ Supplied with two Strain Relief straps per connector; spares available under **order code M80-0030006**.
- ❖ Stamped contact ensures co-planarity.

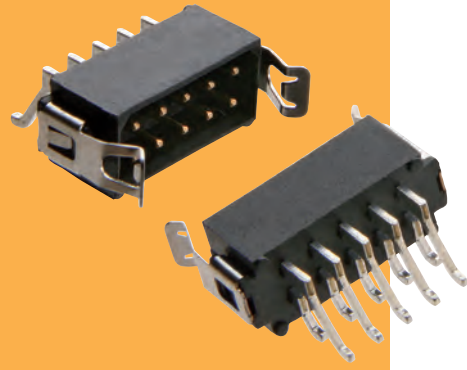

DATAMATE L-TEK

NO LATCHES	CALCULATION	LOCKING LATCH	CALCULATION
	<b>A</b> B + 5.6		<b>A</b> B + 6.1
	<b>B</b> Total no. of contacts - 2		<b>B</b> Total no. of contacts - 2

STRAIN RELIEF STRAP	Supplied with connector	Recommended PC Board Pattern

### HOW TO ORDER

**M80 - 66X XX 42**

<b>SERIES CODE</b>	M80	<b>FINISH</b>	42 Gold + Tin
<b>TYPE</b>	66X 665 No Latches 666 Locking Latch	<b>TOTAL NO. OF CONTACTS</b>	04, 06, 08, 10, 12, 14, 16, 18, 20, 26, 34

All dimensions in mm.

# Datamate L-Tek Connectors

## Male Crimp Kit

- Part numbers are for a complete kit of a housing and the applicable number of contacts.
- Contacts are rear insertable.
- Spare contacts are available - see the following page.

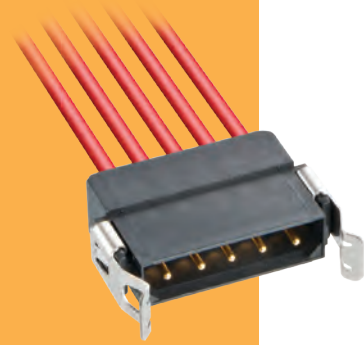

DATAMATE L-TEK

SINGLE ROW	CALCULATION	DOUBLE ROW	CALCULATION
	<b>A</b> B + 5.6		<b>A</b> B + 5.6
Latches (when fitted) add 0.5mm to overall length 'A'	<b>B</b> (Total no. of contacts - 1) x 2	Latches (when fitted) add 0.5mm to overall length 'A'	<b>B</b> Total no. of contacts - 2

TOOLS	WIRE STRIPPING DETAILS
<p><b>Recommended Crimp Tool</b> - M22520/2-01</p> <p><b>Positioner</b> - T5747</p> <p><b>Contact Insertion/Removal Tool</b> - Z80-280</p> <ul style="list-style-type: none"> <li>Spare contacts shown on following page.</li> <li>Instruction sheets available at <a href="http://www.harwin.com/instructions">www.harwin.com/instructions</a>.</li> </ul>	

### HOW TO ORDER

**M80 - 8XX XX 05**

SERIES CODE

SINGLE ROW	DOUBLE ROW	
806	810	Small Bore (24-28 AWG), No Latches
807	811	Large Bore (22 AWG), No Latches
808	812	Small Bore (24-28 AWG), Locking Latch
809	813	Large Bore (22 AWG), Locking Latch

FINISH

05 Gold

TOTAL NO. OF CONTACTS

02, 03, 04, 05, 06, 07	Single Row
04, 06, 08, 10, 12	Double Row

All dimensions in mm.

# Datamate L-Tek Connectors

## Spare Male Crimp Contacts

- Barrel Crimp Contacts are supplied with the connectors - see previous page. Use the order code for extra Spare crimps.

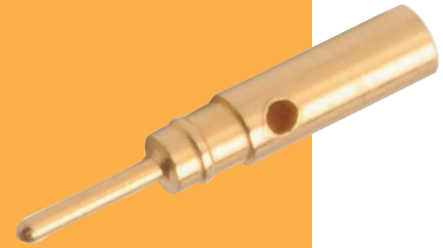

DATAMATE L-TEK

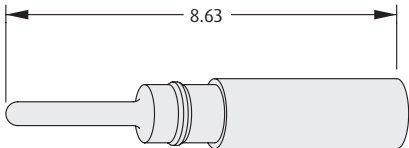
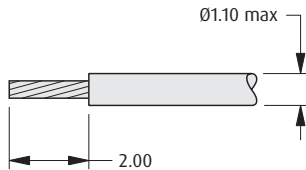
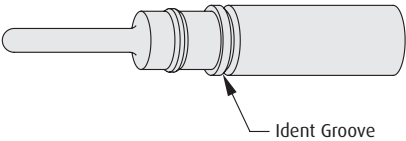
CRIMP CONTACTS	WIRE STRIPPING DETAILS								
<p><b>Large Bore (22 AWG)</b></p> 									
<p><b>Small Bore (24 to 28 AWG)</b></p> 	<p><b>TOOLS</b></p> <p><b>Recommended Crimp Tool</b> - M22520/2-01  <b>Positioner</b> - T5747  <b>Contact Insertion/Removal Tool</b> - Z80-280</p> <p>❖ Instruction sheets available at <a href="http://www.harwin.com/instructions">www.harwin.com/instructions</a>.</p>								
HOW TO ORDER									
<p style="text-align: center;"><b>M80 - 04X 00 05</b></p> <div style="display: flex; justify-content: space-between; align-items: flex-start;"> <div style="width: 30%;"> <p><b>SERIES CODE</b></p> <table border="1" style="width: 100%;"> <thead> <tr> <th colspan="2">TYPE</th> </tr> </thead> <tbody> <tr> <td style="text-align: center;"><b>040</b></td> <td>Large Bore (22 AWG)</td> </tr> <tr> <td style="text-align: center;"><b>041</b></td> <td>Small Bore (24-28 AWG)</td> </tr> </tbody> </table> </div> <div style="width: 30%; text-align: center;"> <p><b>FINISH</b></p> <table border="1" style="width: 100%;"> <tbody> <tr> <td style="text-align: center;"><b>05</b></td> <td>Gold</td> </tr> </tbody> </table> </div> </div>		TYPE		<b>040</b>	Large Bore (22 AWG)	<b>041</b>	Small Bore (24-28 AWG)	<b>05</b>	Gold
TYPE									
<b>040</b>	Large Bore (22 AWG)								
<b>041</b>	Small Bore (24-28 AWG)								
<b>05</b>	Gold								

All dimensions in mm.

# Datamate Tooling

- ❖ Instruction sheets can be accessed at [www.harwin.com/instructions](http://www.harwin.com/instructions).
- ❖ A Datamate Crimping Instruction video is available at [www.harwin.com/harwintv](http://www.harwin.com/harwintv).

HAND CRIMP TOOL	HAND CRIMP TOOL																
<ul style="list-style-type: none"> <li>❖ Standard circular crimp tool BS5210-3A-300 and MIL specification M22520/2-01.</li> <li>❖ Precision tool with ratchet mechanism and 8-indent form.</li> <li>❖ Must be used with applicable positioner shown below.</li> <li>❖ Instruction sheet available.</li> </ul>  <table border="1" data-bbox="412 1024 808 1104"> <thead> <tr> <th colspan="2">ORDER CODE</th> </tr> </thead> <tbody> <tr> <td>Signal contacts</td> <td>M22520/2-01</td> </tr> </tbody> </table>	ORDER CODE		Signal contacts	M22520/2-01	<ul style="list-style-type: none"> <li>❖ Standard circular crimp tools.</li> <li>❖ Precision tool with ratchet mechanism and 8-indent form.</li> <li>❖ Must be used with applicable positioner shown below.</li> <li>❖ Instruction sheets available.</li> </ul>  <table border="1" data-bbox="1089 989 1511 1104"> <thead> <tr> <th colspan="2">ORDER CODE</th> </tr> </thead> <tbody> <tr> <td>Inner contact of Coax contacts</td> <td>Z80-292</td> </tr> <tr> <td>Power crimp contacts</td> <td>Z80-294</td> </tr> </tbody> </table>	ORDER CODE		Inner contact of Coax contacts	Z80-292	Power crimp contacts	Z80-294						
ORDER CODE																	
Signal contacts	M22520/2-01																
ORDER CODE																	
Inner contact of Coax contacts	Z80-292																
Power crimp contacts	Z80-294																
HAND CRIMP TOOL	POSITIONER																
<ul style="list-style-type: none"> <li>❖ Standard coax crimp tool for crimping the outer sleeve of Mix-Tek coax contacts.</li> <li>❖ Instruction sheet available.</li> </ul>  <table border="1" data-bbox="412 1812 808 1892"> <thead> <tr> <th colspan="2">ORDER CODE</th> </tr> </thead> <tbody> <tr> <td>Outer sleeve of Coax contacts</td> <td>Z80-293</td> </tr> </tbody> </table>	ORDER CODE		Outer sleeve of Coax contacts	Z80-293	<ul style="list-style-type: none"> <li>❖ Used with applicable hand crimp tool.</li> </ul>  <table border="1" data-bbox="1005 1665 1511 1892"> <thead> <tr> <th colspan="2">ORDER CODE</th> </tr> </thead> <tbody> <tr> <td>Signal contacts: Male L-Tek, all Female</td> <td>T5747</td> </tr> <tr> <td>Signal contacts: Male J-Tek, Mix-Tek</td> <td>Z80-193</td> </tr> <tr> <td>Inner contact of Coax contacts</td> <td>Z80-291</td> </tr> <tr> <td>Female T-Contact</td> <td>Z80-444</td> </tr> <tr> <td>Power crimp contacts</td> <td>Z80-295</td> </tr> </tbody> </table>	ORDER CODE		Signal contacts: Male L-Tek, all Female	T5747	Signal contacts: Male J-Tek, Mix-Tek	Z80-193	Inner contact of Coax contacts	Z80-291	Female T-Contact	Z80-444	Power crimp contacts	Z80-295
ORDER CODE																	
Outer sleeve of Coax contacts	Z80-293																
ORDER CODE																	
Signal contacts: Male L-Tek, all Female	T5747																
Signal contacts: Male J-Tek, Mix-Tek	Z80-193																
Inner contact of Coax contacts	Z80-291																
Female T-Contact	Z80-444																
Power crimp contacts	Z80-295																

All dimensions in mm.

# Datamate Tooling

- ❖ Instruction sheets can be accessed at [www.harwin.com/instructions](http://www.harwin.com/instructions).
- ❖ A Datamate Crimping Instruction video is available at [www.harwin.com/harwintv](http://www.harwin.com/harwintv).

INSERTION/REMOVAL TOOL	REMOVAL TOOL																
<ul style="list-style-type: none"> <li>❖ For inserting crimped contacts into the rear of housings.</li> <li>❖ Suitable for all Datamate signal Barrel crimp contacts.</li> </ul>  <table border="1" style="margin-left: auto; margin-right: auto;"> <thead> <tr> <th colspan="2" style="background-color: #f4a460;">ORDER CODE</th> </tr> </thead> <tbody> <tr> <td>Signal contacts</td> <td><b>Z80-280</b></td> </tr> </tbody> </table>	ORDER CODE		Signal contacts	<b>Z80-280</b>	<ul style="list-style-type: none"> <li>❖ To aid removal of special cable contacts from Mix-Tek connectors.</li> </ul>  <table border="1" style="margin-left: auto; margin-right: auto;"> <thead> <tr> <th colspan="2" style="background-color: #f4a460;">ORDER CODE</th> </tr> </thead> <tbody> <tr> <td>Power &amp; Coax cable contacts</td> <td><b>Z80-290</b></td> </tr> </tbody> </table>	ORDER CODE		Power & Coax cable contacts	<b>Z80-290</b>								
ORDER CODE																	
Signal contacts	<b>Z80-280</b>																
ORDER CODE																	
Power & Coax cable contacts	<b>Z80-290</b>																
SEPARATOR TOOL	DRIVERS																
<ul style="list-style-type: none"> <li>❖ Recommended for unplugging L-Tek latched connectors (tool releases the latches prior to disengagement).</li> <li>❖ Can also be used with unlatched connectors.</li> <li>❖ Adjustable to suit all housing sizes.</li> </ul>  <table border="1" style="margin-left: auto; margin-right: auto;"> <thead> <tr> <th colspan="2" style="background-color: #f4a460;">ORDER CODE</th> </tr> </thead> <tbody> <tr> <td>L-Tek</td> <td><b>Z80-299</b></td> </tr> </tbody> </table>	ORDER CODE		L-Tek	<b>Z80-299</b>	<ul style="list-style-type: none"> <li>❖ Mating jackscrews to be tightened to a torque of 23cmN max.</li> <li>❖ Board mount nuts and bolts to be tightened to a torque of 21 ±2cmN.</li> </ul>  <table border="1" style="margin-left: auto; margin-right: auto;"> <thead> <tr> <th colspan="2" style="background-color: #f4a460;">ORDER CODE</th> </tr> </thead> <tbody> <tr> <td>Slotted Nut Screwdriver (board mount nuts)</td> <td><b>Z80-298</b></td> </tr> <tr> <td>1.5mm A/F Hex Drive Bit (board mount bolts)</td> <td><b>Z9950-00</b></td> </tr> <tr> <td>2mm A/F Hex Drive Bit (floating jackscrews)</td> <td><b>Z9951-00</b></td> </tr> <tr> <td>1.5mm A/F Ball Hex Driver (board mount bolts)</td> <td><b>Z9952-00</b></td> </tr> <tr> <td>2mm A/F Ball Hex Driver (floating jackscrews)</td> <td><b>Z9953-00</b></td> </tr> </tbody> </table>	ORDER CODE		Slotted Nut Screwdriver (board mount nuts)	<b>Z80-298</b>	1.5mm A/F Hex Drive Bit (board mount bolts)	<b>Z9950-00</b>	2mm A/F Hex Drive Bit (floating jackscrews)	<b>Z9951-00</b>	1.5mm A/F Ball Hex Driver (board mount bolts)	<b>Z9952-00</b>	2mm A/F Ball Hex Driver (floating jackscrews)	<b>Z9953-00</b>
ORDER CODE																	
L-Tek	<b>Z80-299</b>																
ORDER CODE																	
Slotted Nut Screwdriver (board mount nuts)	<b>Z80-298</b>																
1.5mm A/F Hex Drive Bit (board mount bolts)	<b>Z9950-00</b>																
2mm A/F Hex Drive Bit (floating jackscrews)	<b>Z9951-00</b>																
1.5mm A/F Ball Hex Driver (board mount bolts)	<b>Z9952-00</b>																
2mm A/F Ball Hex Driver (floating jackscrews)	<b>Z9953-00</b>																

All dimensions in mm.