

Applications

- Distributed Power Architectures
- Telecommunications Equipment
- LAN/WAN Applications
- Data Processing Applications

Features

- Low Profile – 12.7 mm Height
- Input/output Isolation: 1500VDC, Basic Insulation
- High Efficiency - Up to 92% at Full Load
- Start-up into High Capacitive Load
- Low Conducted and Radiated EMI
- Output Overcurrent Protection
- Output Overvoltage Protection
- Back Drive Protection
- Overtemperature Protection
- Remote Sense
- Remote On/Off (Primary Referenced), Positive or Negative Logic
- Output Voltage Trim Adjust
- UL 1950 Recognition, CSA 22.2 No. 950-95 certification, TUV IEC950

Description

The QHS is a series of high efficiency, high-density, single output DC/DC converters for onboard conversion of standard telecom and datacom input voltages into isolated low voltage outputs in a through-hole mounting package. The two-board construction provides a cool environment for control components and the integrated metallic substrate PCB provides superior thermal management for power components resulting in enhanced product reliability. A heatsink can be conveniently and effectively attached to the IMS base plate for operations in elevated ambient conditions or where airflow is minimal.

Model Selection						
Model	Input Voltage VDC	Input Current, Max ADC	Output Voltage Vout, VDC	Output Rated Current $I_{rated, ADC}$	Output Ripple/Noise, mV p-p	Typical Efficiency @ $I_{rated, \%}$
QHS12ZH	36-75	4.5	12.0	12	150	91
QHS25ZG	36-75	4.3	5.0	25	150	92
QHS40ZE	36-75	4.5	3.3	40	150	89
QHS40ZD	36-75	3.3	2.5	40	100	88
QHS40ZB	36-75	2.5	1.8	40	100	85
QHS50ZA	36-75	2.7	1.5	50	100	79
QHS50ZY	36-75	2.3	1.2	50	100	76

Absolute Maximum Ratings

Stresses in excess of the absolute maximum ratings may cause performance degradation, adversely effect long-term reliability and cause permanent damage to the converter.

Table 1. Absolute Maximum Ratings

Parameter	Conditions/Description	Min	Max	Units
Input voltage	Continuous		75	VDC
	Transient		80	VDC
Operating Temperature	Base Plate Temperature	-40	100	°C
Storage Temperature		-40	125	°C
ON/OFF Control Voltage	Referenced to -Vin		20	VDC

Environmental and Mechanical Specifications

All specifications apply over specified input voltage, output load, and temperature range, unless otherwise noted.

Table 2. Environmental and Mechanical Specifications

Parameter	Conditions/Description	Min	Nom	Max	Units
Shock	Halfsine wave, 3 axes	50			g
Sinusoidal Vibration	GR-63-Core, Section 5.4.2	1			g
Weight			1.2/35		Oz/g
Water Washing	Standard process		Yes		
MTBF	Per Bellcore TR-NWT-000332		1,980		kHrs

Isolation Specifications

All specifications apply over specified input voltage, output load, and temperature range, unless otherwise noted.

Table 3. Isolation Specifications

Parameter	Conditions/Description	Min	Nom	Max	Units
Insulation Safety Rating		Basic			
Isolation Voltage	Input to output, input to base plate	1500			VDC
Isolation Voltage	Output to base plate	500			VDC
Isolation Resistance		10			MOhm
Isolation Capacitance			1000		pF

Input Specifications

All specifications apply over specified input voltage, output load, and temperature range, unless otherwise noted.

Table 4. Input Specifications

Parameter	Conditions/Description	Min	Nom	Max	Units
Input Voltage	Continuous	36	48	75	VDC
Turn-On Input Voltage	Ramping Up		34		VDC
Turn-Off Input Voltage	Ramping Down		33		VDC
Input over voltage protection	Ramping up	76		84	VDC
Turn-On Time	To Output Regulation Band 100% Resistive Load			5	ms
Input Reflected Ripple Current	Full Load, 12uH source inductance			60	mA p-p
Inrush Transient	Vin=Vin.max			0.1	A ² s

Output Specifications

All specifications apply over specified input voltage, output load and temperature range, unless otherwise noted.

Table 5. Output Specifications

Parameter	Conditions/Description	Min	Nom	Max	Units
Output Voltage Setpoint Accuracy	Vin=Vin.nom, Full Load				
1.8V		-1.67		1.67	%Vout
2.5V		-2.00		2.00	%Vout
3.3V		-1.5		1.5	%Vout
12V		-2.0		2.0	%Vout
Output Current*	See selection chart for I _{rated}	0		100	%I _{rated}
Line Regulation	Vin.min to Vin.max, I _{rated}			0.2	%Vout
Load Regulation	Vin=Vin.nom, 10% to 100%I _{rated}			0.75	%Vout
Total output voltage regulation	Over all input voltage, load, and temperature conditions	-3		3	%Vout
Remote Sense Headroom***				10%	%Vout
Dynamic Regulation	50-75% load step change				
Peak Deviation			5		%Vout
Settling Time	to 1% error band		250		μs
Admissible Load Capacitance	I _{rated} , Nom Vin			27,000	μF
	12V			8,000	μF
Output Current Limit Threshold**	Vout≤0.97Vout.nom	110		150	%I _{rated}
Switching Frequency	2.5V and 1.8V		300		kHz
	3.3V		450		kHz
	12V		400		kHz
Overvoltage Protection, Non Latching	Over all input voltage and load conditions	120		140	%Vout
Trim Range	I _{rated} , Vin=Vnom	90		110	%Vout

* At I_{out}<I_{out.min}, the output may contain low frequency component that exceeds ripple specifications.

** Overcurrent protection is non-latching with auto recovery.

*** Vout can be increased up to 10% via the sense leads or up to 10% via the trim function, however total output voltage trim from all sources should not exceed 10% of Vout

Feature Specifications

All specifications apply over specified input voltage, output load and temperature range, unless otherwise noted.

Table 6. Feature Specifications

Parameter	Conditions/Description	Min	Nom	Max	Units
Shutdown (ON/OFF)					
Negative Logic	On/Off signal is low – converter is ON				
Converter ON		-0.5		1.8	VDC
Source Current	ON/OFF pin is connected to -Vin			1	mADC
Converter OFF		3.5		20	VDC
Open Circuit Voltage	ON/OFF pin is floating			5	VDC
Positive Logic	On/Off signal is low–converter is OFF				
Converter ON		3.5		20	VDC
Open Circuit Voltage	ON/OFF pin is floating			5	VDC
Converter OFF		-0.5		1.8	VDC
Source Current	ON/OFF pin is connected to -Vin			1	mADC
Overtemperature Protection	Average board temperature		105		°C

Characteristic Curves

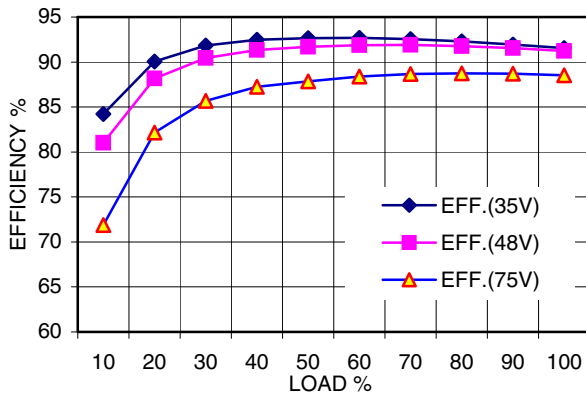

Figure 1. QHS12ZH Efficiency vs. Output Load

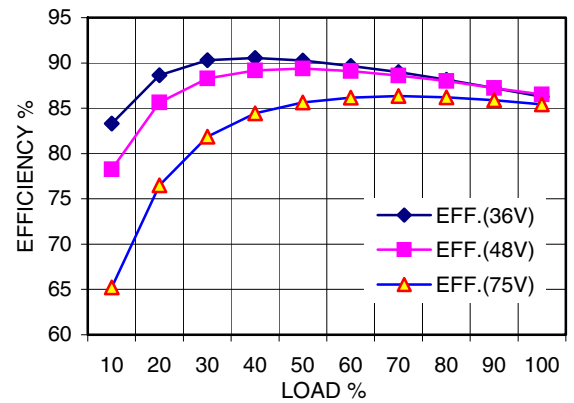

Figure 3. QHS40ZD Efficiency vs. Output Load

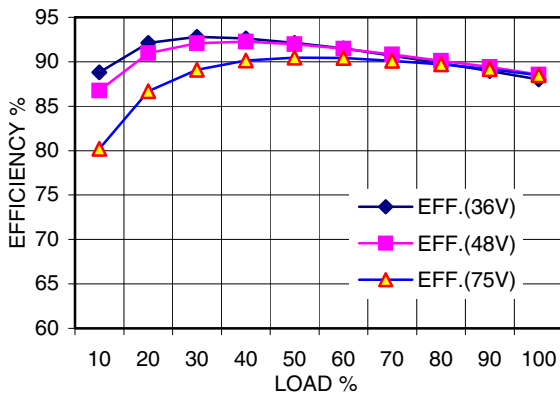

Figure 2. QHS40ZE Efficiency vs. Output Load

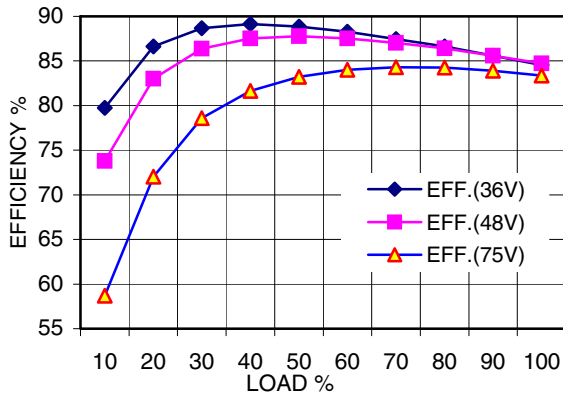

Figure 4. QHS40ZB Efficiency vs. Output Load

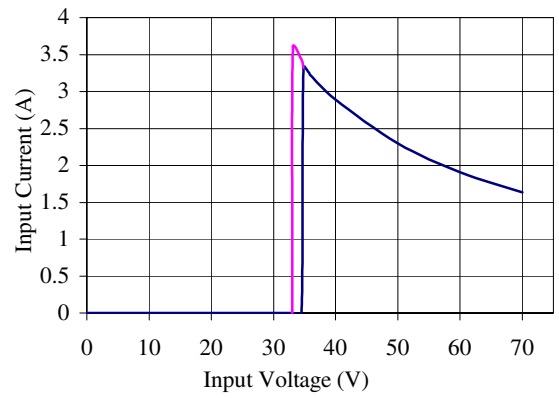

Figure 7. QHS40ZD Input Characteristics

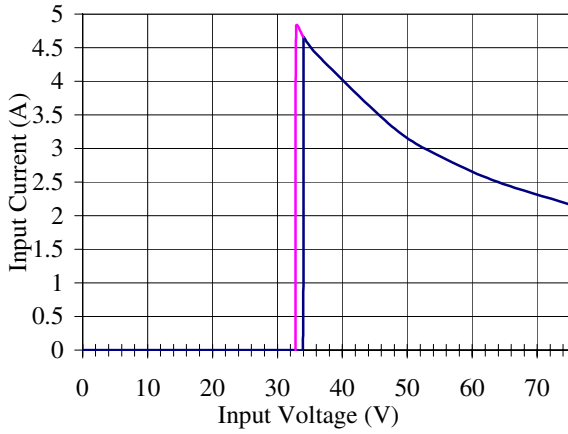

Figure 5. QHS12ZH Input Characteristics

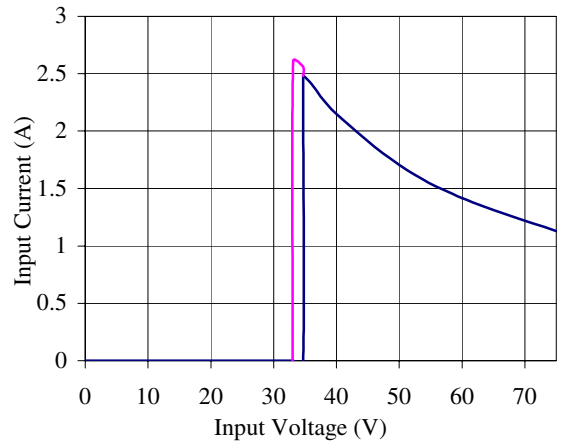

Figure 8. QHS40ZB Input Characteristics

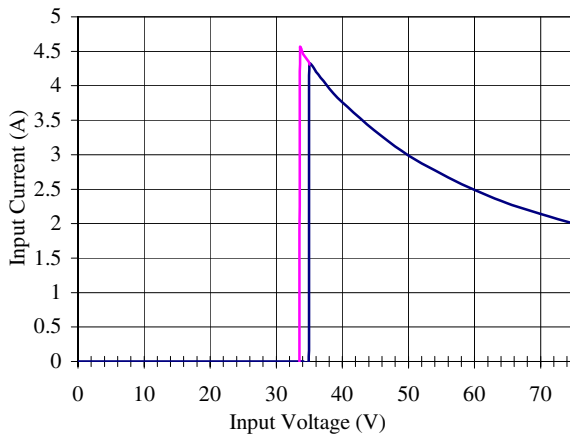

Figure 6. QHS40ZE Input Characteristics

Typical Application

Figure 9 shows the recommended connections for the QHS Series converter.

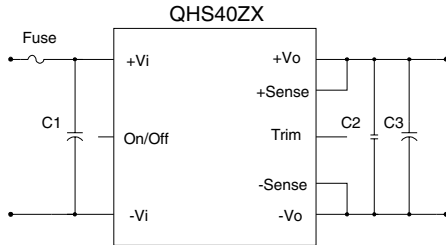

Figure 9. Typical Application of the QHS Series

The QHS Series converters do not require any external components for proper operation. However, if the distribution of the input voltage to the converter contains significant inductance, the capacitor C1 may be required to enhance performance of the converter. A minimum of a 33µF electrolytic capacitor with the ESR<0.7Ω is recommended for the QHS Series.

Refer to the “Inrush Current Control Application Note” on www.power-one.com for suggestions on how to limit the magnitude of the inrush current.

For output decoupling we recommend to use a 10µF tantalum and a 1µF ceramic capacitors connected directly across the output pins of the converter. Note, that the capacitors do not substitute the filtering required by the load.

Shutdown Feature Description

The ON/OFF pin in the QHS Series converters functions as a normal soft shutdown. It is referenced to the -Vin pin (see Figure 7). With the positive logic, when the ON/OFF pin is pulled low, the output is turned off and the unit goes into a very low input power mode.

With negative logic, when the ON/OFF pin is pulled low, the unit is turned on.

An open collector switch is recommended to control the voltage between the ON/OFF pin and the -Vin pin of the converter. The ON/OFF pin is pulled up internally, so no external voltage source is required. The user should avoid connecting a resistor between the ON/OFF pin and the +Vin pin.

When the ON/OFF pin is used to achieve remote control, the user must take care to insure that the pin reference for the control is really the -Vin pin. The

control signal must not be referenced ahead of EMI filtering, or remotely from the unit. Optically coupling the information and locating the optical coupler directly at the module will solve any of these problems.

Note:

If the ON/OFF pin is not used, it can be left floating (positive logic), or connected to the -Vin pin (negative logic).

Output Voltage Trim

Industry Standard Trim

The units trim up with a resistor from the TRIM pin to the +Sense pin and trim down with a resistor from the TRIM pin to the -Sense pin as shown in Figure 10.

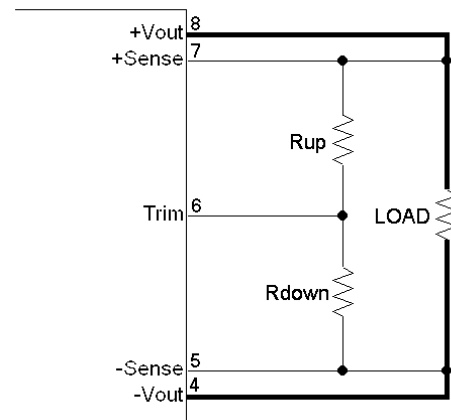

Figure 10. QHS Series Positive Trim Schematic

The equations below determine the trim resistor value required to achieve a ΔV change in the output voltage.

$$R_{adj-up} = \left(\frac{5.1V_o(100 + \Delta\%)}{1.225\Delta\%} - \frac{510}{\Delta\%} - 10.2 \right) k\Omega$$

$$R_{adj-down} = \left(\frac{510}{\Delta\%} - 10.2 \right) k\Omega$$

where ΔV% is the output voltage change expressed in percents of the nominal output voltage, Vout.

Notes:

1. When the output voltage is trimmed up, the output power from the converter must not exceed its maximum rating. The power is determined by measuring the output voltage on the output pins, and multiplying it by the output current.
2. In order to avoid creating apparent load regulation degradation, it is important that the trim resistors are connected directly to the remote sense pins, and not to the load or to traces going to the load.
3. The QHS Series converters will trim down further than the 10% limit. In general, this is permissible. The user must confirm that the results are acceptable in the application.

Safety Considerations

The QHS Series converters feature 1500 Volt DC isolation from input to output. The input to output resistance is greater than 10M Ω . These converters are provided with Basic insulation between input and output circuits according to all IEC60950 based standards. Nevertheless, if the system using the converter needs to receive safety agency approval, certain rules must be followed in the design of the system. In particular, all of the creepage and clearance requirements of the end-use safety requirements must be observed. These documents include UL60950 - CSA60950-00 and EN60950, although other or additional requirements may be needed for specific applications.

The QHS Series converters have no internal fuse. The external fuse must be provided to protect the system from catastrophic failure as shown in Figure 7. The user can select a fuse based upon the highest inrush transient at the maximum input voltage and the maximum input current of the converter, which occurs at the minimum input voltage. Both input traces and the chassis ground trace (if applicable) must be capable of conducting a current of 1.5 times the value of the fuse without opening. The fuse must not be placed in the grounded input line, if any.

In order for the output of the QHS Series converter to be considered as SELV (Safety Extra Low Voltage) or TNV-1, according to all IEC60950 based standards, one of the following requirements must be met in the system design:

- If the voltage source feeding the module is SELV or TNV-2, the output of the converter may be grounded or ungrounded.
- If the voltage source feeding the module is ELV, the output of the converter may be considered SELV only if the output is grounded per the requirements of the standard.

- If the voltage source feeding the module is a Hazardous Voltage Secondary Circuit, the voltage source feeding the module must be provided with at least Basic insulation between the source to the converter and any hazardous voltages. The entire system, including the QHS converter, must pass a dielectric withstand test for Reinforced insulation. Design of this type of systems requires expert engineering and understanding of the overall safety requirements and should be performed by qualified personnel.

Thermal Considerations

The QHS Series converters are designed for natural or forced convection cooling. The maximum allowable output current of the converters is determined by meeting the derating criteria for all components used in the converters. For example, the maximum semiconductor junction temperature is not allowed to exceed 120°C to ensure reliable long-term operation of the converters. Contact Power-One for the complete list of the derating criteria.

The graphs in Figures 11-14 show the maximum output current of the QHS Series converters at different ambient temperatures under both natural and forced (longitudinal airflow direction, from pin 1 to pin 3) convection.

For example, from Figure 11, the QHS40ZE operating at 55°C can deliver up to 18A reliably with 100LFM forced air, while up to 25A reliably with 400LFM forced air.

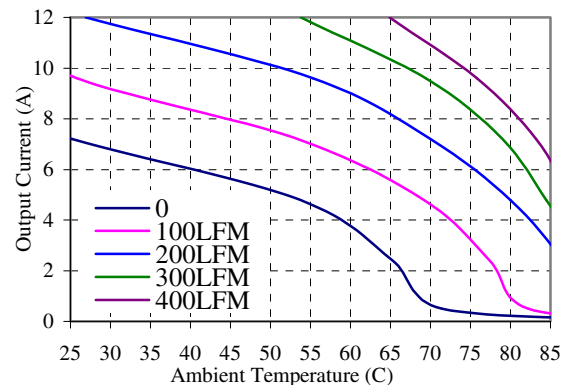

Figure 11. QHS12ZH (12V) Derating Curves

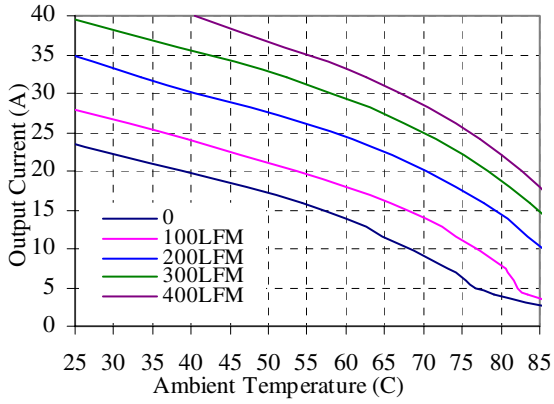

Figure 12. QHS40ZE (3.3V) Derating Curves

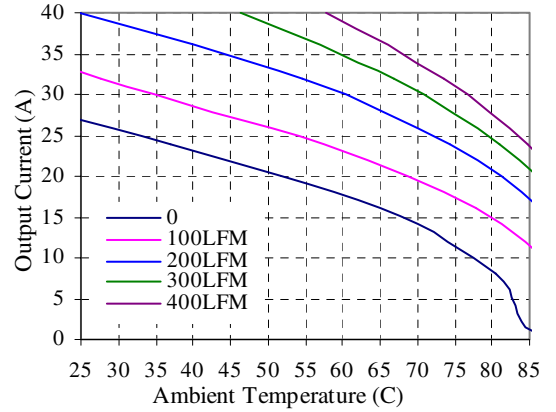

Figure 14. QHS40ZB (1.8V) Derating Curves

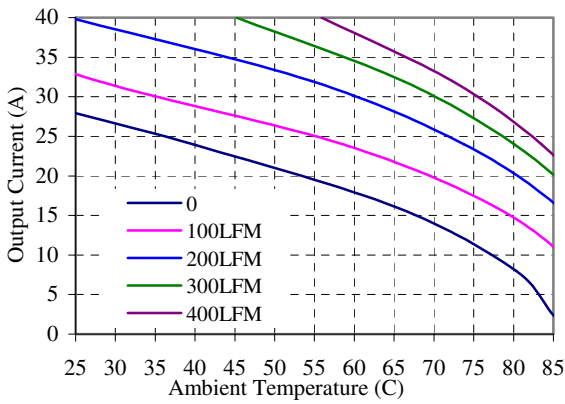

Figure 13. QHS40ZD (2.5V) Derating Curves

Mechanical Drawing

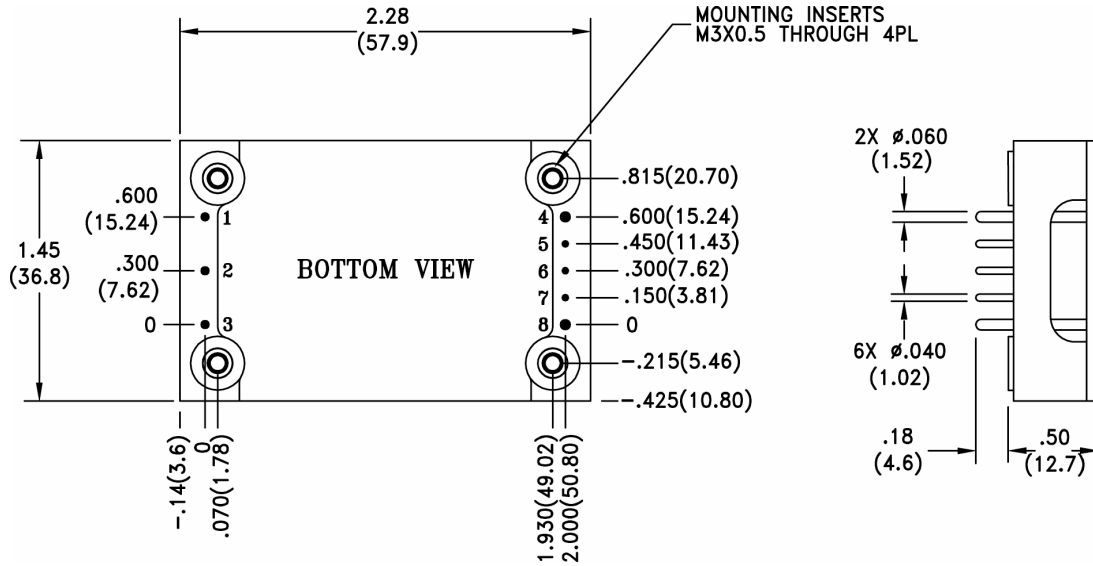

Figure 15. Mechanical Drawing

Table 7. Pinout/Functions

Pin	Function
1	-Vin
2	On/off
3	+Vin
4	-Vout
5	-Sense
6	Trim
7	+Sense
8	+Vout

Mechanical Tolerances

Inches	Millimeters
X.XX ±0.020	X.X ±0.5
X.XXX ±0.010	X.XX ±0.25
Pin	
±0.002	±0.05

Ordering:

Table 8. Ordering Information

Options	Suffixes to add to part number
Remote ON/OFF	Positive- Standard, no suffix required
	Negative- Add "NT" suffix
Pin Length	0.18"- Standard, no suffix required
	0.11"- Add "8" suffix
	0.15"- Add "9" suffix

Notes:

Consult factory for the complete list of available options.

NUCLEAR AND MEDICAL APPLICATIONS - Power-One products are not authorized for use as critical components in life support systems, equipment used in hazardous environments, or nuclear control systems without the express written consent of the respective divisional president of Power-One, Inc.

TECHNICAL REVISIONS - The appearance of products, including safety agency certifications pictured on labels, may change depending on the date manufactured. Specifications are subject to change without notice.