

## Mechanical Dimensions: Inches [mm]

Tolerances  $\pm 0.012$  [0.3] Unless Otherwise Specified

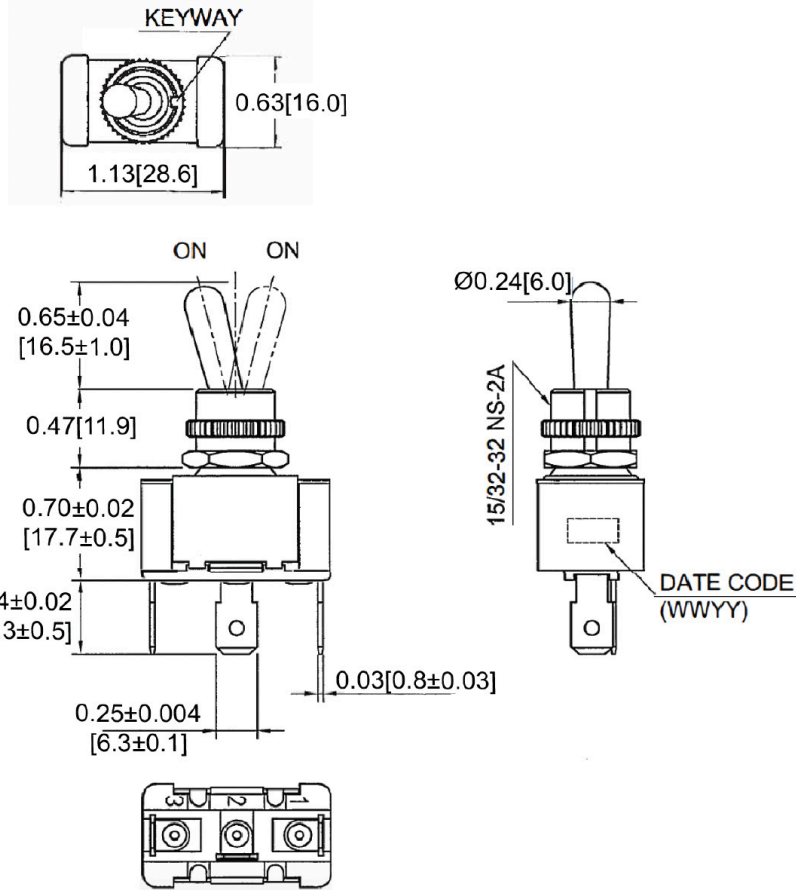

## Mounting Hole

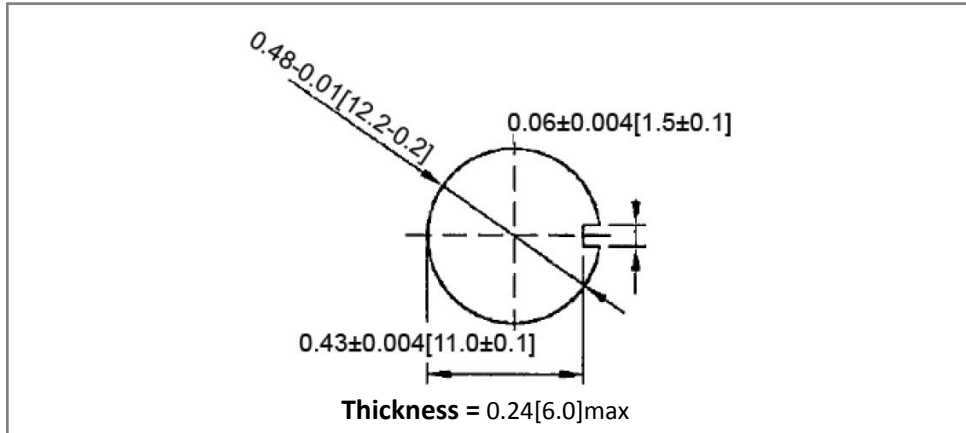

## Circuit Diagram

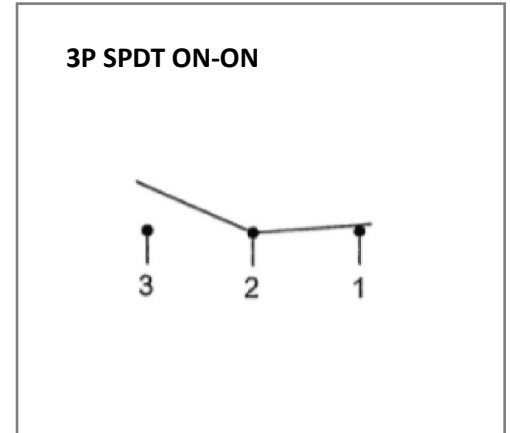

## Electrical Specifications

<b>Rating</b>	20A 125V AC, 10A 277V AC, 3/4HP 125-250V AC 12(4)A 125/250V AC
<b>Contact Resistance</b>	50m ohm Max
<b>Insulation Resistance</b>	DC 500V 100M ohm Min
<b>Dielectric Strength</b>	AC 1500V 1 minute
<b>Operation Temperature</b>	-20°C ~ 85°C

## Material Specifications

<b>Operation Force</b>	700gf $\pm$ 250gf
	1 Hex Nut Assy
	1 Knurl Nut Assy

Rev	Date of issue	Revision Notes	Designed	Approved
A	11-29-2021	Initial Drawing	RC	OF