

Revision Level			Revision Record	Changed	Date	Approved	Date
Drawing	State	Part					
01.2	DESIGN RELEASE		SEE ECN# 014408	FDS	04/23/18	EJH	04/23/18

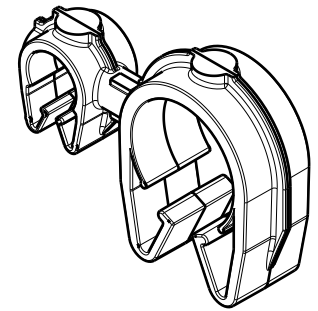

ISOMETRIC VIEW

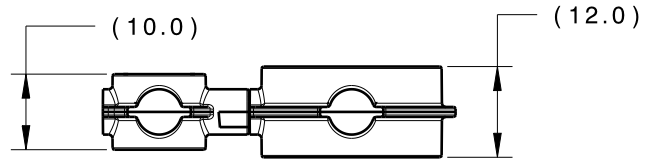
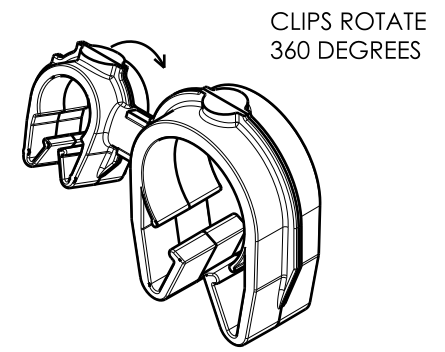
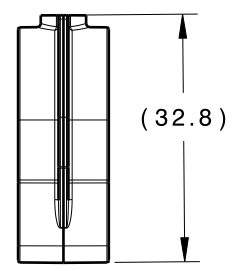
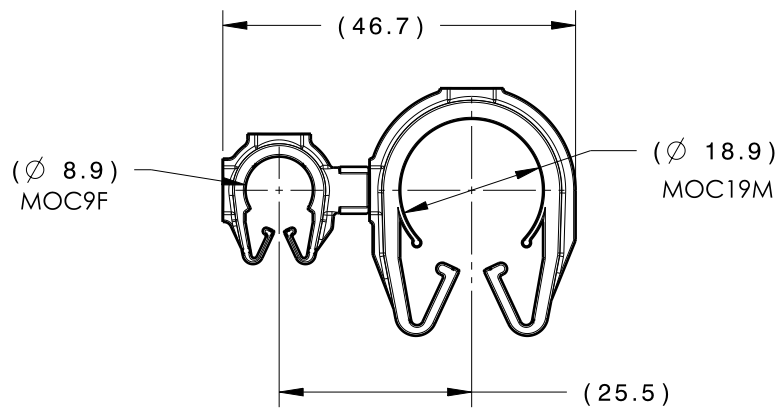

CLIPS ROTATE 360 DEGREES

ISOMETRIC VIEW ROTATED

TYPE	MOC9F	MOC19M
HARNESS	8.5MM-10.0MM	17.0MM-20.0MM
HOSE	8.0MM-10.0MM	17.0MM-20.0MM
HARD PIPE/TUBE	9.0MM-10.0MM	19.0MM-21.8MM

*RECOMMENDED SIZES MAY DIFFER DEPENDING ON THE APPLICATION, PRODUCT REQUIREMENTS AND MATERIALS USED

GLOBAL PART DESCRIPTION 	MOC9F			MOC19M		
	DRAWING	MATERIAL	COLOR	DRAWING	MATERIAL	COLOR
MOC9FMOC19M-PA66HIRHS-BK	16-0317-000-CSU	PA66HIRHS	BLACK	16-0322-000-CSU	PA66HIRHS	BLACK

Material SEE CHART COLOR: SEE CHART	Units millimeters	The copyright of this drawing is reserved by HellermannTyton. It is issued on condition that it is not reproduced, copied or disclosed to a third party, either wholly or in part, without the consent of HellermannTyton.	Drawn	TAT	2/21/17	Article/Type-No	MOC9FMOC19M	Scale	1:1
	Tolerance defined on each dimension		Approved	EJH	2/28/17	Title	 9MM MOC COUPLED TO A 19MM MOC	Project Number	16-0326
			HellermannTyton			North America Email: corp@htamericas.com Web: www.hellermann.tyton.com		Drawing-No	PRODUCTION : Phase
16-0326-267-CSU							Sheet	1/1	