

PART NUMBER	VERSION	BAY 1/BAY 2	TOTAL CIRCUITS	DIM A	SALES DRAWING (SEE NOTE 7)
170672-2294	2 BAY	122/172	294	125.03	SD-170672-2294
170672-2278	2 BAY	146/132	278	118.63	SD-170672-2278
170672-1200	1 BAY	200	200	84.20	SD-170672-1200
170672-1170	1 BAY	170	170	72.20	SD-170672-1170
170672-2108	2 BAY	86/22	108	50.6	SD-170672-2108

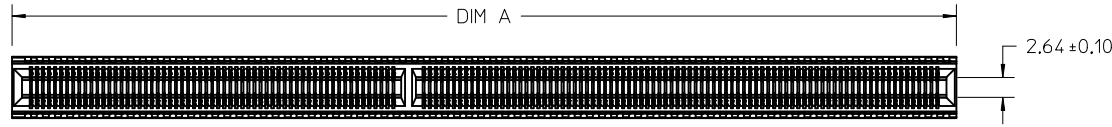

2 BAY EDGE LINE

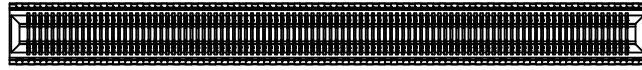

1 BAY EDGE LINE

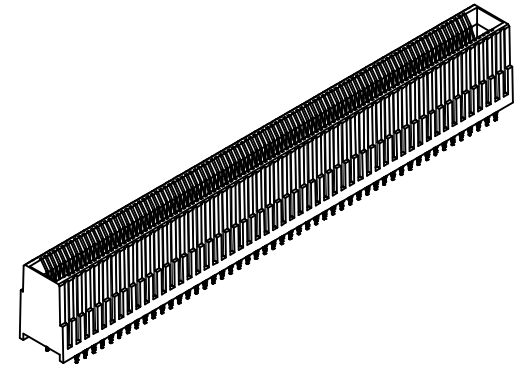
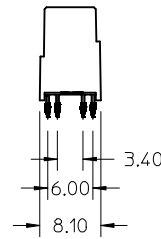
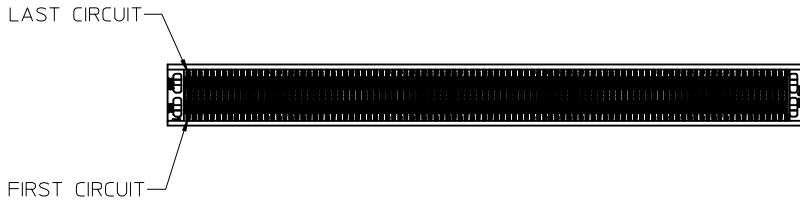
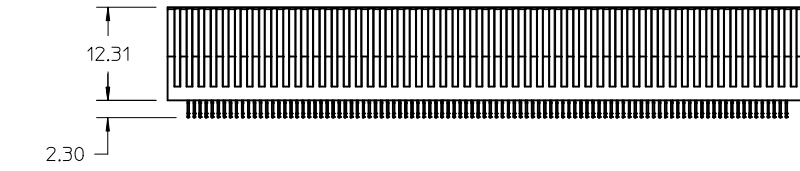

NOTES:

- MATERIAL:
HOUSING - GLASS FILLED THERMOPLASTIC, 94-V0, BLACK
TERMINALS - COPPER ALLOY
- FINISH:
CONTACT AREA: HARD GOLD -0.76µm MIN OVER 3.80µ NICKEL
COMPLIANT AREA: TIN - 0.76/1.52µm OVER NICKEL
- REFER TO PS-75594-999 PRODUCT SPECIFICATION FOR ALL ELECTRICAL, MECHANICAL AND ENVIRONMENTAL SPECIFICATIONS.
- PROCESSING: PRESSFIT TO PC BOARD.
- MATING PC BOARD THICKNESS = 2.36±10% OVER CONTACT PADS.
- THIS PART CONFORMS TO CLASS B REQUIREMENTS OF COSMETIC SPEC PS-45499-002
- FOR EDGE CARD AND MOUNTING PCB LAYOUT DETAIL SEE CORRESPONDING SALES DRAWING.

CORRECT 10% TOLERANCE EC NO: UCP2017-1945 DRAWN BY: DRWIN:POFF CHECKED BY: CHKD:MORGAN APPROVED BY: APPR:KLANG	DESCRIPTION REV: C1	QUALITY SYMBOLS ▽=0 ▽=0 ▽=0	GENERAL TOLERANCES (UNLESS SPECIFIED)		DIMENSION STYLE MM ONLY	SCALE 2:1	DESIGN UNITS METRIC	THIRD ANGLE PROJECTION	
			mm	INCH	DRAWN BY DROSCA	DATE 2010/07/01	EDGELINE 12.5GB 0.093" PCB 0.8MM PITCH		
			4 PLACES ± ---	± ---	CHECKED BY JCOMERC I	DATE 2011/03/28			
			3 PLACES ± ---	± ---	APPROVED BY JCOMERC I	DATE 2010/10/25	molex		
ANGULAR ±1/2°		DRAFT WHERE APPLICABLE MUST REMAIN WITHIN DIMENSIONS		SIZE C	SEE TABLE	DOCUMENT NO. SD-170672-0001	SHEET NO. 1 OF 1		
THIS DRAWING CONTAINS INFORMATION THAT IS PROPRIETARY TO MOLEX INCORPORATED AND SHOULD NOT BE USED WITHOUT WRITTEN PERMISSION									

PART NUMBER	VERSION	BAY 1/BAY 2	TOTAL CIRCUITS	DIM A	SALES DRAWING (SEE NOTE 7)
170672-2294	2 BAY	122/172	294	125.03	SD-170672-2294
170672-2278	2 BAY	146/132	278	118.63	SD-170672-2278
170672-1200	1 BAY	200	200	84.20	SD-170672-1200
170672-1170	1 BAY	170	170	72.20	SD-170672-1170
170672-2108	2 BAY	86/22	108	50.6	SD-170672-2108

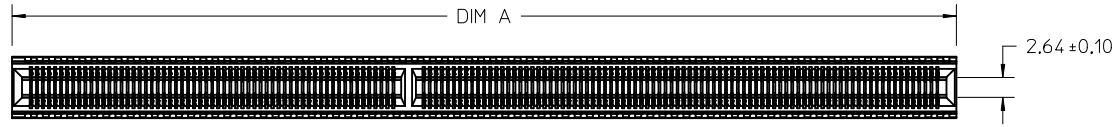

2 BAY EDGE LINE

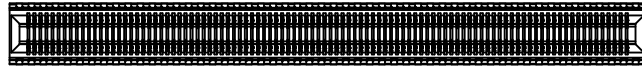

1 BAY EDGE LINE

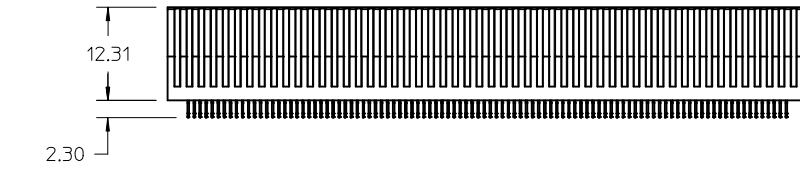

LAST CIRCUIT

FIRST CIRCUIT

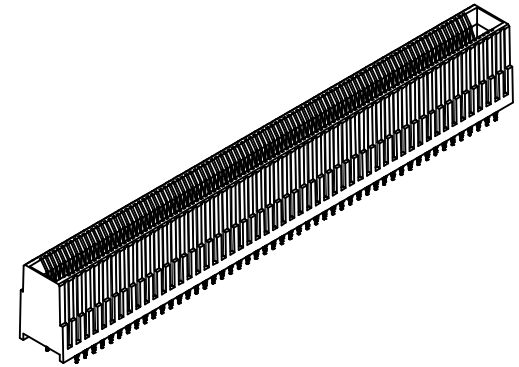
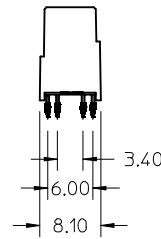

NOTES:

- MATERIAL:
HOUSING - GLASS FILLED THERMOPLASTIC, 94-V0, BLACK
TERMINALS - COPPER ALLOY
- FINISH:
CONTACT AREA: HARD GOLD -0.76µm MIN OVER 3.80µ NICKEL
COMPLIANT AREA: TIN - 0.76/1.52µm OVER NICKEL
- REFER TO PS-75594-999 PRODUCT SPECIFICATION FOR ALL ELECTRICAL, MECHANICAL AND ENVIRONMENTAL SPECIFICATIONS.
- PROCESSING: PRESSFIT TO PC BOARD.
- MATING PC BOARD THICKNESS = 2.36±10% OVER CONTACT PADS.
- THIS PART CONFORMS TO CLASS B REQUIREMENTS OF COSMETIC SPEC PS-45499-002
- FOR EDGE CARD AND MOUNTING PCB LAYOUT DETAIL SEE CORRESPONDING SALES DRAWING.

REV	DESCRIPTION	QUALITY SYMBOLS
C1	CORRECT 10% TOLERANCE IEC NO: UCP2017-1945 DRW:MP0FF 2017/03/09 CHK:DMORGAN 2017/03/09 APPR:KLANG 2017/03/15	

GENERAL TOLERANCES (UNLESS SPECIFIED)	
mm	INCH
4 PLACES ± .005	± .0004
3 PLACES ± .003	± .0002
2 PLACES ± .002	± .0001
1 PLACE ± .001	± .00005
0 PLACE ±	±
ANGULAR ±1/2°	
DRAFT WHERE APPLICABLE MUST REMAIN WITHIN DIMENSIONS	

DIMENSION STYLE	
MM ONLY	
DRAWN BY	DATE
DROSCA	2010/07/01
CHECKED BY	DATE
JCOMERCI	2011/03/28
APPROVED BY	DATE
JCOMERCI	2010/10/25
MATERIAL NO.	
SEE TABLE	
SIZE	C

SCALE	DESIGN UNITS	THIRD ANGLE PROJECTION
2:1	METRIC	
EDGE LINE 12.5GB 0.093" PCB 0.8MM PITCH		
DOCUMENT NO.	SHEET NO.	
SD-170672-0001	1 OF 1	

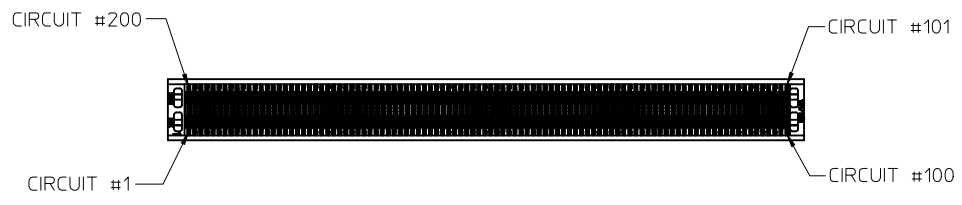
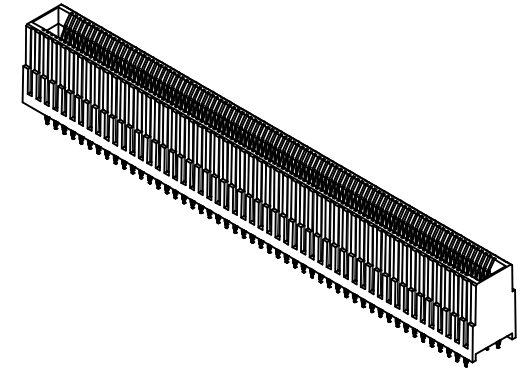
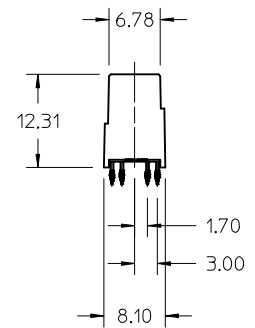
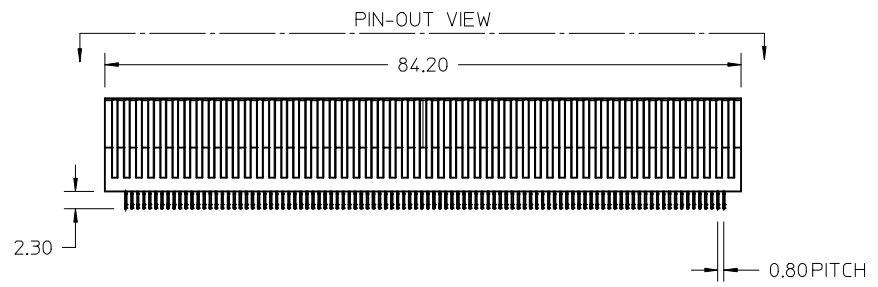
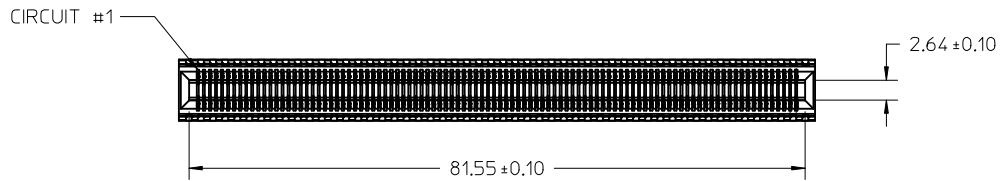

- NOTES:
1. MATERIAL:
HOUSING - GLASS FILLED THERMOPLASTIC, 94-V0, BLACK
TERMINALS - COPPER ALLOY
 2. FINISH:
CONTACT AREA: HARD GOLD -0.76µm MIN OVER 3.80µ NICKEL
COMPLIANT AREA: TIN - 0.76/1.52µm OVER NICKEL
 3. REFER TO PS-75594-999 PRODUCT SPECIFICATION FOR ALL ELECTRICAL, MECHANICAL AND ENVIRONMENTAL SPECIFICATIONS.
 4. REFER TO PK-76693-900 FOR ALL PACKAGING SPECIFICATIONS.
 5. PROCESSING: PRESSFIT TO PC BOARD.
 6. MATING PC BOARD THICKNESS = 2.36±10% OVER CONTACT PADS.
 7. THIS PART CONFORMS TO CLASS B REQUIREMENTS OF COSMETIC SPEC PS-45499-002.

CORRECT 10% TOLERANCE EC NO: UCP2017-1945 2017/03/09 DRWN:MP0FF 2017/03/09 CHKD:DMORGAN 2017/03/15 APPR:KLANG	QUALITY SYMBOLS ∇=0 ∇=1 ∇=1	GENERAL TOLERANCES (UNLESS SPECIFIED)		DIMENSION STYLE MM ONLY	SCALE 2:1	DESIGN UNITS METRIC	THIRD ANGLE PROJECTION
		4 PLACES ± --- ± --- 3 PLACES ± --- ± --- 2 PLACES ± 0.13 ± --- 1 PLACE ± 0.25 ± --- 0 PLACE ± ±	mm INCH	DRAWN BY DATE DROSCA 2011/03/10	TITLE EDGELINE 12.5GB 0.093" PCB, 0.8MM PITCH 200 CIRCUITS		
		ANGULAR ± 2 °	APPROVED BY DATE JCOMERC I 2011/03/11		DOCUMENT NO. SD-170672-1200		
	REV B1	DRAFT WHERE APPLICABLE MUST REMAIN WITHIN DIMENSIONS	MATERIAL NO. 170672-1200	SIZE C	SHEET NO. 1 OF 4		

EDGE LINE CONNECTOR BOARD MOUNTING

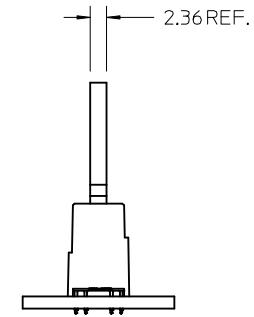
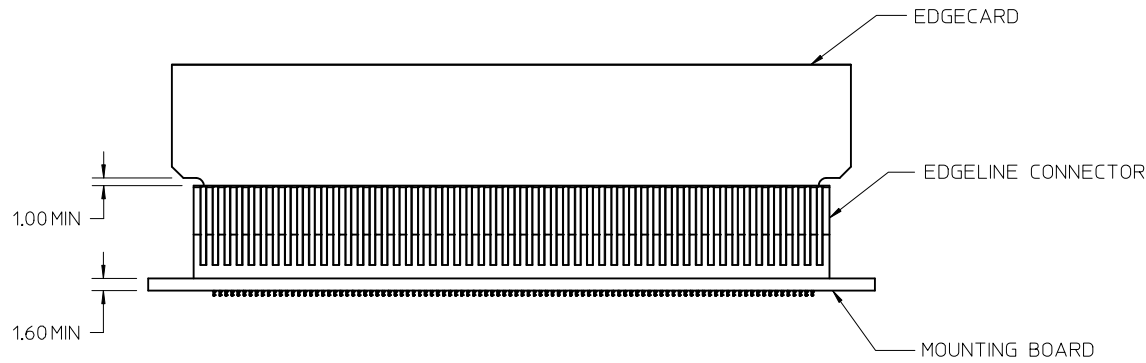

SEE SHEET 1 EC NO: UCP2017-1945 DRWN:MP0FF 2017/03/09 CHKD:DMORGAN 2017/03/09 APPR:KLANG 2017/03/15	QUALITY SYMBOLS	GENERAL TOLERANCES (UNLESS SPECIFIED)	DIMENSION STYLE	SCALE	DESIGN UNITS	THIRD ANGLE PROJECTION
	▽=0	mm INCH	MM ONLY	2:1	METRIC	
	▽=0	4 PLACES ± --- ± ---	DRAWN BY DATE	TITLE		
	▽=0	3 PLACES ± --- ± ---	DROSCA 2011/03/10	EDGE LINE 12.5GB 0.093" PCB, 0.8MM PITCH 200 CIRCUITS		
REV	DESCRIPTION	1 PLACE ± 0.13 ± ---	CHECKED BY DATE	DOCUMENT NO.		
B1		0 PLACE ± 0.25 ± ---	APPROVED BY DATE	SD-170672-1200		
		ANGULAR ± 2 °	JCOMERC I 2011/03/11	SHEET NO.		
		DRAFT WHERE APPLICABLE MUST REMAIN WITHIN DIMENSIONS	MATERIAL NO.	2 OF 4		
			SEE SHEET 1	THIS DRAWING CONTAINS INFORMATION THAT IS PROPRIETARY TO MOLEX INCORPORATED AND SHOULD NOT BE USED WITHOUT WRITTEN PERMISSION		

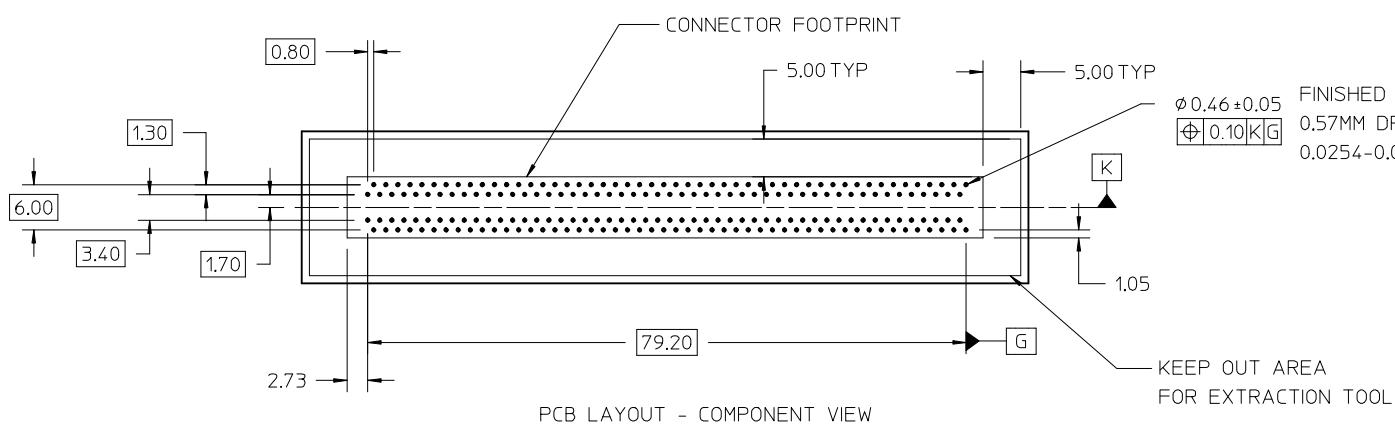

PCB LAYOUT - COMPONENT VIEW

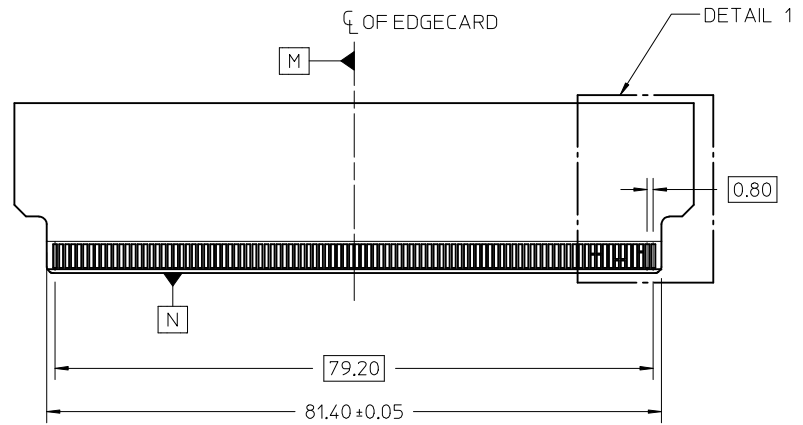
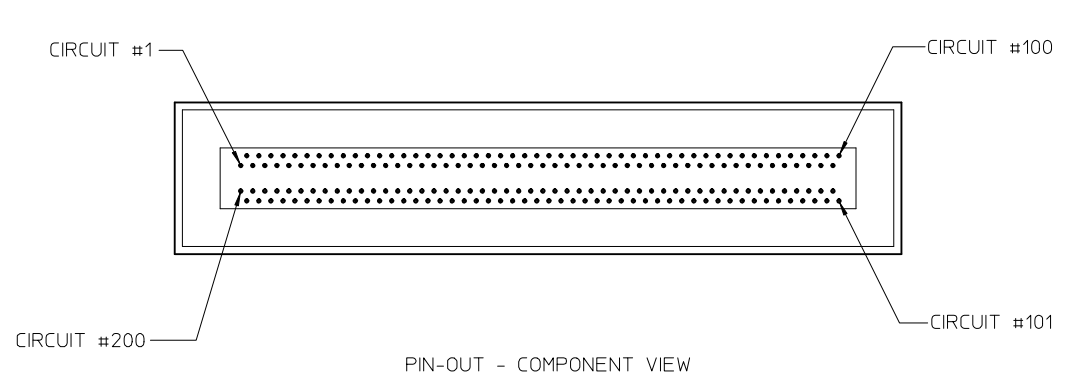

SEE SHEET 1 IEC NO: UCP2017-1945 2017/03/09 DRAWN: PPOFF 2017/03/09 CHKD: DMORGAN 2017/03/15 APPR: KLANG	QUALITY SYMBOLS	GENERAL TOLERANCES (UNLESS SPECIFIED)	DIMENSION STYLE	SCALE	DESIGN UNITS	THIRD ANGLE PROJECTION
	▽=0	mm INCH	MM ONLY	2:1	METRIC	
	▽=0	4 PLACES ± --- ± ---	DRAWN BY DATE			
	▽=0	3 PLACES ± --- ± ---	DROSCA 2011/03/10			
REV	DESCRIPTION	1 PLACE ± 0.13 ± ---	CHECKED BY DATE	EDGELINE 12.5GB 0.093" PCB, 0.8MM PITCH 200 CIRCUITS molex		
B1		2 PLACES ± 0.25 ± ---	APPROVED BY DATE			
		0 PLACE ± ±	JCOMERC I 2011/03/11	DOCUMENT NO. SD-170672-1200 SHEET NO. 3 OF 4		
		ANGULAR ± 2 °	MATERIAL NO.			
DRAFT WHERE APPLICABLE MUST REMAIN WITHIN DIMENSIONS			SEE SHEET 1	THIS DRAWING CONTAINS INFORMATION THAT IS PROPRIETARY TO MOLEX INCORPORATED AND SHOULD NOT BE USED WITHOUT WRITTEN PERMISSION		

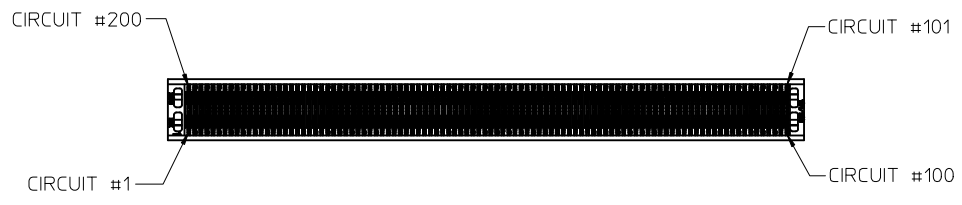
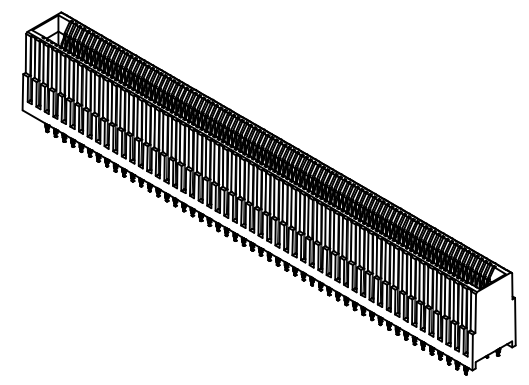
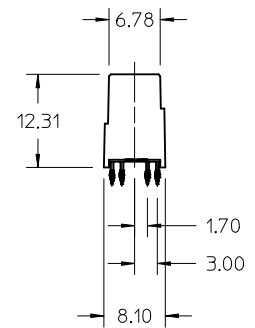
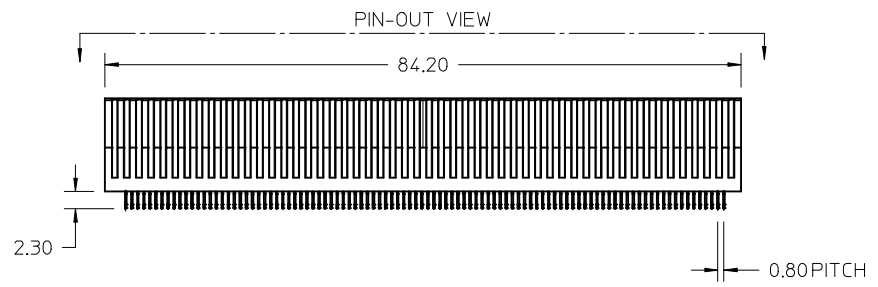
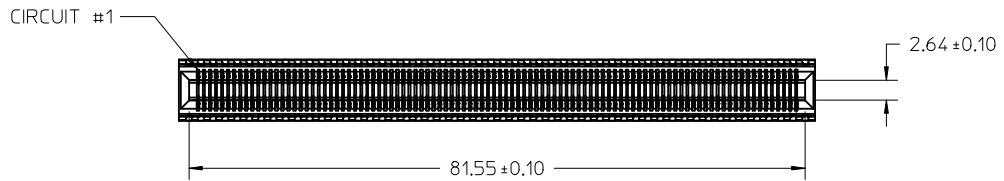

- NOTES:
1. MATERIAL:
HOUSING - GLASS FILLED THERMOPLASTIC, 94-V0, BLACK
TERMINALS - COPPER ALLOY
 2. FINISH:
CONTACT AREA: HARD GOLD -0.76 μ m MIN OVER 3.80 μ NICKEL
COMPLIANT AREA: TIN - 0.76/1.52 μ m OVER NICKEL
 3. REFER TO PS-75594-999 PRODUCT SPECIFICATION FOR ALL ELECTRICAL, MECHANICAL AND ENVIRONMENTAL SPECIFICATIONS.
 4. REFER TO PK-76693-900 FOR ALL PACKAGING SPECIFICATIONS.
 5. PROCESSING: PRESSFIT TO PC BOARD.
 6. MATING PC BOARD THICKNESS = 2.36 \pm 10% OVER CONTACT PADS.
 7. THIS PART CONFORMS TO CLASS B REQUIREMENTS OF COSMETIC SPEC PS-45499-002.

CORRECT 10% TOLERANCE EC NO: UCP2017-1945 2017/03/09 DRWN:MP0FF 2017/03/09 CHKD:DMORGAN 2017/03/15 APPR:KLANG	QUALITY SYMBOLS ∇=0 ∇=1 ∇=1	GENERAL TOLERANCES (UNLESS SPECIFIED)		DIMENSION STYLE MM ONLY	SCALE 2:1	DESIGN UNITS METRIC	THIRD ANGLE PROJECTION
		4 PLACES ± --- ± --- 3 PLACES ± --- ± --- 2 PLACES ± 0.13 ± --- 1 PLACE ± 0.25 ± --- 0 PLACE ± ±	mm INCH	DRAWN BY DATE DROSCA 2011/03/10	TITLE EDGELINE 12.5GB 0.093" PCB, 0.8MM PITCH 200 CIRCUITS		
		ANGULAR ± 2 °	APPROVED BY DATE JCOMERC I 2011/03/11		DOCUMENT NO. SD-170672-1200		
	REV B1	DESCRIPTION	DRAFT WHERE APPLICABLE MUST REMAIN WITHIN DIMENSIONS		MATERIAL NO. 170672-1200	SHEET NO. 1 OF 4	THIS DRAWING CONTAINS INFORMATION THAT IS PROPRIETARY TO MOLEX INCORPORATED AND SHOULD NOT BE USED WITHOUT WRITTEN PERMISSION

EDGE LINE CONNECTOR BOARD MOUNTING

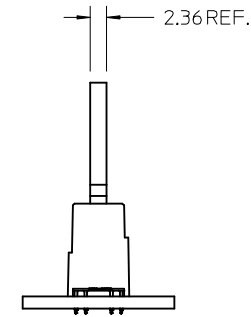
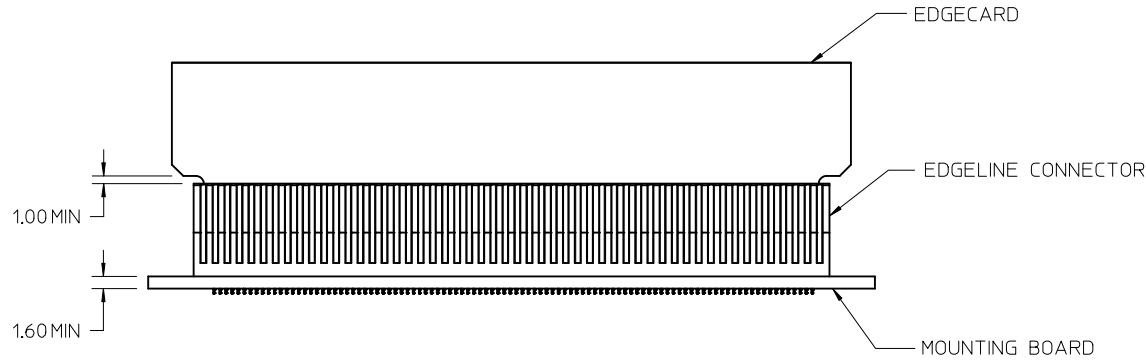

SEE SHEET 1 EC NO: UCP2017-1945 DRWN: MPOFF CHKD: MORGAN APPR: KLANG	2017/03/09 2017/03/09 2017/03/15	QUALITY SYMBOLS ▽=0 ▽=0 ▽=0	GENERAL TOLERANCES (UNLESS SPECIFIED) <table border="1"> <tr> <th></th> <th>mm</th> <th>INCH</th> </tr> <tr> <td>4 PLACES</td> <td>± .005</td> <td>± .0004</td> </tr> <tr> <td>3 PLACES</td> <td>± .005</td> <td>± .0004</td> </tr> <tr> <td>2 PLACES</td> <td>± 0.13</td> <td>± .005</td> </tr> <tr> <td>1 PLACE</td> <td>± 0.25</td> <td>± .010</td> </tr> <tr> <td>0 PLACE</td> <td>±</td> <td>±</td> </tr> </table>		mm	INCH	4 PLACES	± .005	± .0004	3 PLACES	± .005	± .0004	2 PLACES	± 0.13	± .005	1 PLACE	± 0.25	± .010	0 PLACE	±	±	DIMENSION STYLE MM ONLY DRAWN BY: DROSCA DATE: 2011/03/10 CHECKED BY: _____ DATE: _____ APPROVED BY: JCOMERC I DATE: 2011/03/11	SCALE: 2:1 DESIGN UNITS: METRIC THIRD ANGLE PROJECTION	TITLE: EDGE LINE 12.5GB 0.093" PCB, 0.8MM PITCH 200 CIRCUITS molex
		mm	INCH																					
	4 PLACES	± .005	± .0004																					
	3 PLACES	± .005	± .0004																					
2 PLACES	± 0.13	± .005																						
1 PLACE	± 0.25	± .010																						
0 PLACE	±	±																						
B1	DESCRIPTION	ANGULAR ± 2 ° DRAFT WHERE APPLICABLE MUST REMAIN WITHIN DIMENSIONS	MATERIAL NO. SEE SHEET 1	DOCUMENT NO. SD-170672-1200	SHEET NO. 2 OF 4																			
THIS DRAWING CONTAINS INFORMATION THAT IS PROPRIETARY TO MOLEX INCORPORATED AND SHOULD NOT BE USED WITHOUT WRITTEN PERMISSION																								

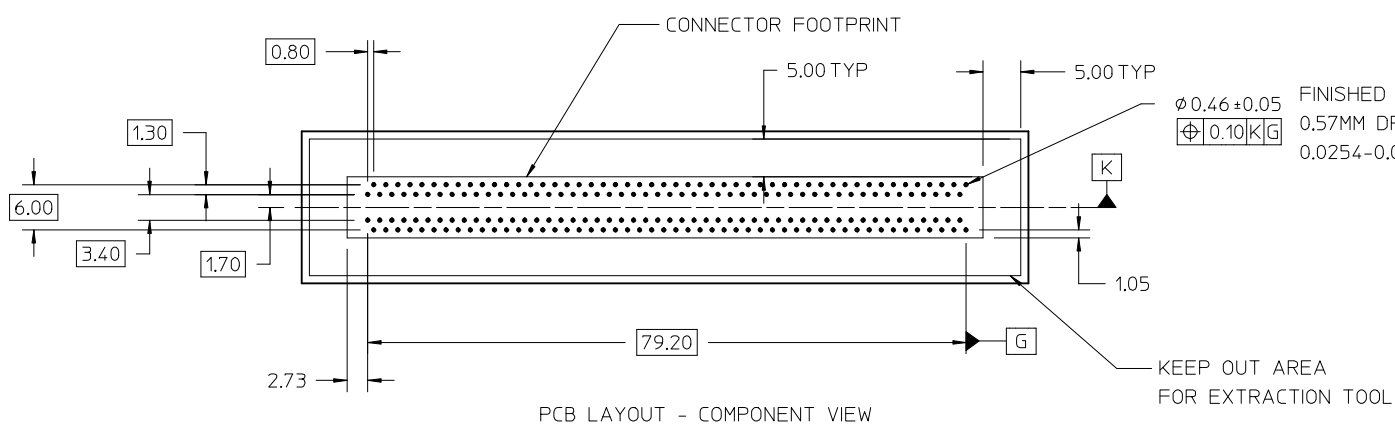

PCB LAYOUT - COMPONENT VIEW

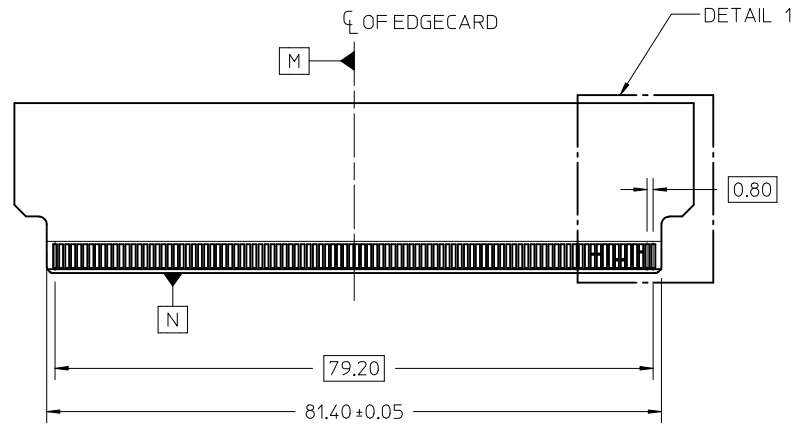
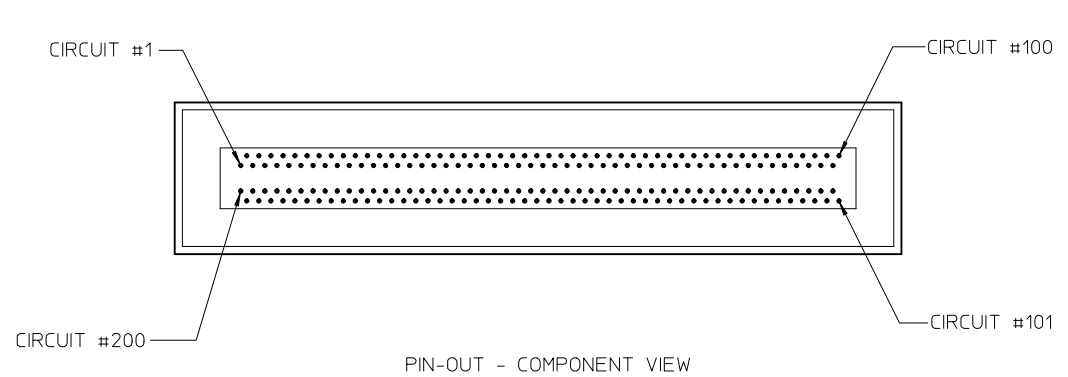

SEE SHEET 1 IEC NO: UCP2017-1945 DRAWN BY: DRWIN:POFF 2017/03/09 CHKD:DMORGAN 2017/03/09 APPR:KLANG 2017/03/15	QUALITY SYMBOLS $\nabla = 0$ $\nabla = 0$ $\nabla = 0$	GENERAL TOLERANCES (UNLESS SPECIFIED) <table border="1"> <tr> <th></th> <th>mm</th> <th>INCH</th> </tr> <tr> <td>4 PLACES</td> <td>± ---</td> <td>± ---</td> </tr> <tr> <td>3 PLACES</td> <td>± ---</td> <td>± ---</td> </tr> <tr> <td>2 PLACES</td> <td>± 0.13</td> <td>± ---</td> </tr> <tr> <td>1 PLACE</td> <td>± 0.25</td> <td>± ---</td> </tr> <tr> <td>0 PLACE</td> <td>±</td> <td>±</td> </tr> </table>		mm	INCH	4 PLACES	± ---	± ---	3 PLACES	± ---	± ---	2 PLACES	± 0.13	± ---	1 PLACE	± 0.25	± ---	0 PLACE	±	±	DIMENSION STYLE MM ONLY DRAWN BY: DROSCA DATE: 2011/03/10 CHECKED BY: DATE:	SCALE 2:1 DESIGN UNITS METRIC THIRD ANGLE PROJECTION	TITLE EDGE LINE 12.5GB 0.093" PCB, 0.8MM PITCH 200 CIRCUITS molex
		mm	INCH																				
	4 PLACES	± ---	± ---																				
	3 PLACES	± ---	± ---																				
2 PLACES	± 0.13	± ---																					
1 PLACE	± 0.25	± ---																					
0 PLACE	±	±																					
REV: B1 DESCRIPTION:	ANGULAR ± 2 ° DRAFT WHERE APPLICABLE MUST REMAIN WITHIN DIMENSIONS	APPROVED BY: JCOMERC I DATE: 2011/03/11 MATERIAL NO.: SEE SHEET 1	DOCUMENT NO.: SD-170672-1200	SHEET NO.: 3 OF 4																			
THIS DRAWING CONTAINS INFORMATION THAT IS PROPRIETARY TO MOLEX INCORPORATED AND SHOULD NOT BE USED WITHOUT WRITTEN PERMISSION																							

MODULE EDGE CARD CONTACT DETAIL

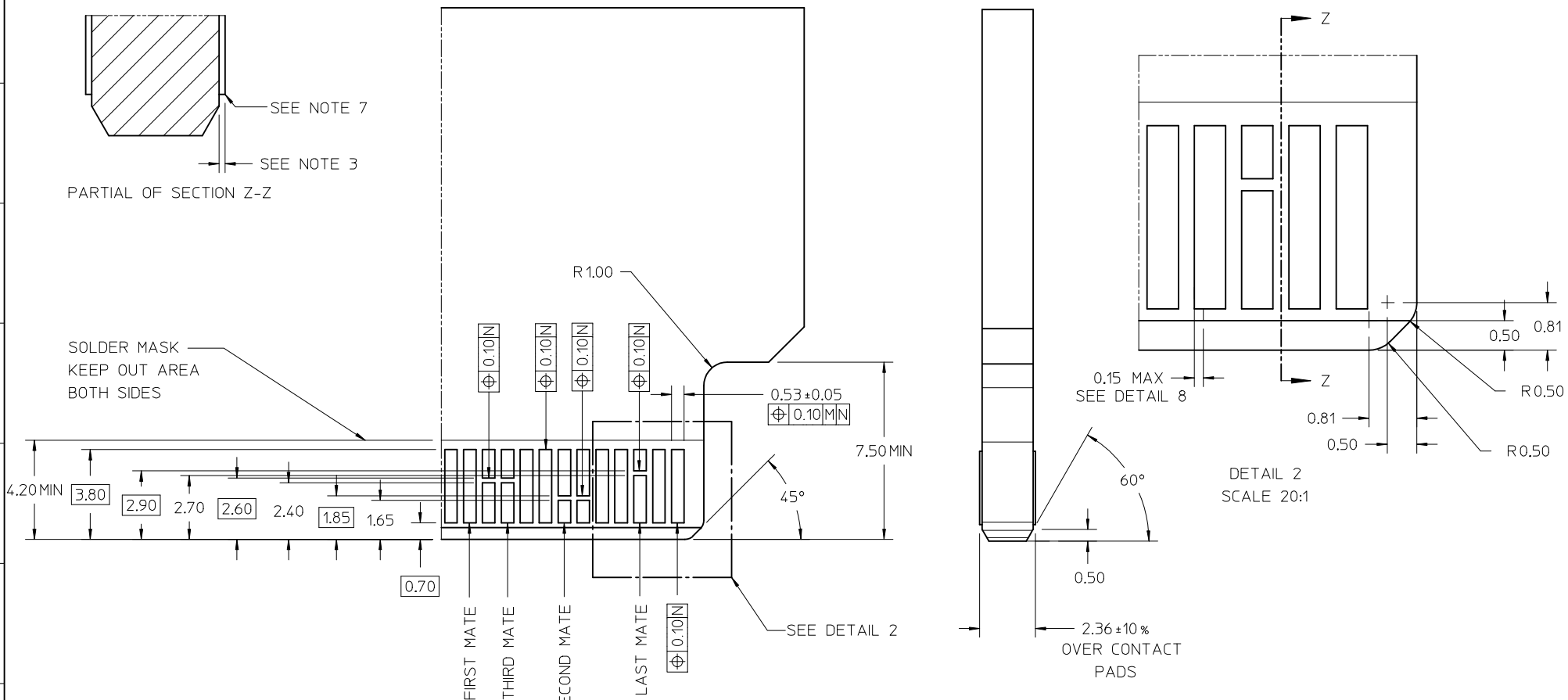

MATING PCB NOTES:

- CONNECTOR LAND CONDITIONS SHALL MEET THE MOST CURRENT REVISION OF PCB SPECIFICATION IPC-6012C-2010 SECTION 3.5.4.4.
- DIMENSIONS APPLY TO LANDS ON BOTH SIDES OF THE BOARD.
- THE THICKNESS OF THE OUTER METAL LAYERS, INCLUDING FOIL, COPPER PLATING, AND THE PROTECTIVE SURFACE FINISH, SHALL BE 0.066mm MAX.
- CHAMFER ROUGHNESS NOT TO EXCEED 3.17 MICROMETERS.
- CHAMFER PROCESS SHALL NOT DAMAGE THE GOLD EDGE LANDS.
- EDGE CARD CHAMFER NOT TO GO THRU GOLD LANDS.
- 0.03mm MAX PLATING OVERHANG ON ALL GOLD LAND EDGES.
- MOLEX RECOMMENDS NO TIE-BARS ON THE LEADING EDGE OF THE GOLD LAND. IF TIE-BARS ARE USED, THEY SHALL BE PLACED TO ONE SIDE OF THE GOLD LAND. APPLIES TO ALL GOLD LANDS.

DETAIL 1
SCALE 8:1

DETAIL 2
SCALE 20:1

SEE SHEET 1 IEC NO: UCP2017-1945 DRWN: PPOFF 2017/03/09 CHKD: MORGAN 2017/03/09 APPR: KLANG 2017/03/15	QUALITY SYMBOLS	GENERAL TOLERANCES (UNLESS SPECIFIED)	DIMENSION STYLE	SCALE	DESIGN UNITS	THIRD ANGLE PROJECTION
	▽=0	mm INCH	MM ONLY	8:1	METRIC	
	▽=0	4 PLACES ± --- ± ---	DRAWN BY DATE	TITLE		
	▽=0	3 PLACES ± --- ± ---	DROSCA 2011/03/10	EDGELINE 12.5GB		
	2 PLACES ± 0.13 ± ---	CHECKED BY DATE	0.093' PCB, 0.8MM PITCH			
	1 PLACE ± 0.25 ± ---	APPROVED BY DATE	200 CIRCUITS			
	0 PLACE ± ±	JCOMERC I 2011/03/11	molex			
	ANGULAR ± 2 °	MATERIAL NO.	DOCUMENT NO.			
	DRAFT WHERE APPLICABLE MUST REMAIN WITHIN DIMENSIONS	SEE SHEET 1	SD-170672-1200			
		SIZE C	THIS DRAWING CONTAINS INFORMATION THAT IS PROPRIETARY TO MOLEX INCORPORATED AND SHOULD NOT BE USED WITHOUT WRITTEN PERMISSION			
B1	REV		SHEET NO. 4 OF 4			