

PLEASE CHECK WWW.MOLEX.COM FOR LATEST PART INFORMATION

Part Number: [0554540370](#)
Status: **Active**
Description: 1.25mm Pitch Mi II System Wire-to-Board Header, Single Row, Right-Angle, 3 Circuits

Documents:

[3D Model](#) [Product Specification PS-54596-018-001 \(PDF\)](#)
[Drawing \(PDF\)](#) [RoHS Certificate of Compliance \(PDF\)](#)

General

Product Family PCB Headers
 Series [55454](#)
 Application Signal, Wire-to-Board
 Product Name Mini Mi II
 UPC 756054760963

Physical

Breakaway No
 Circuits (Loaded) 3
 Circuits (maximum) 3
 Color - Resin Natural
 Durability (mating cycles max) 30
 First Mate / Last Break No
 Glow-Wire Capable No
 Guide to Mating Part No
 Keying to Mating Part None
 Lock to Mating Part Yes
 Material - Plating Mating Tin
 Material - Plating Termination Tin
 Net Weight 246.100/mg
 Number of Rows 1
 Orientation Right Angle
 PC Tail Length 3.00mm
 PCB Locator Yes
 PCB Retention Yes
 PCB Thickness - Recommended 1.60mm
 Packaging Type Tray
 Pitch - Mating Interface 1.25mm
 Polarized to Mating Part Yes
 Shrouded Fully
 Stackable No
 Surface Mount Compatible (SMC) No
 Temperature Range - Operating -40° to +105°C
 Termination Interface: Style Through Hole

Electrical

Current - Maximum per Contact 1.5A
 Voltage - Maximum 100V

Material Info

Reference - Drawing Numbers

Product Specification PS-54596-018-001
 Sales Drawing SD-55454-007

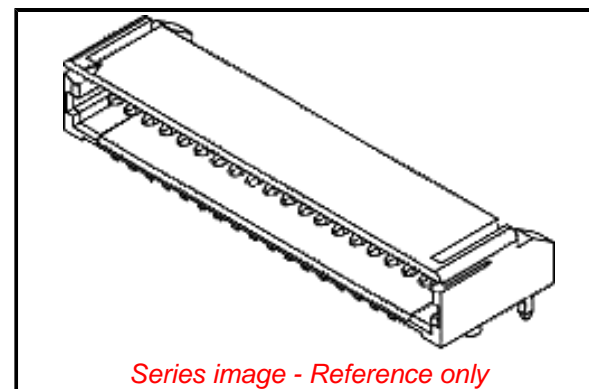

EU ELV

Not Relevant

EU RoHS

Compliant

REACH SVHC

Not Contained Per -
 ED/61/2018 (27 June
 2018)

Halogen-Free

Status

Not Low-Halogen

**Need more information on product
 environmental compliance?**

Email productcompliance@molex.com
 Please visit the [Contact Us](#) section for any
 non-product compliance questions.

China ROHS

ELV

Prop65

RoHS Phthalates

Green Image

Not Relevant

Compliant

Not Contained

Search Parts in this Series

[55454 Series](#)

Mates With

[51336 PBT Polyester, Glass-filled Housing,](#)
[54596 PA Polyamide Housing](#)