

TOLERANCE UNLESS OTHERWISE SPECIFIED	
.X	±0.25
.XX	±0.13
.XXX	±0.10

THIS IS A C.A.D. GENERATED DRAWING
DO NOT MAKE MANUAL REVISIONS TO MASTER.

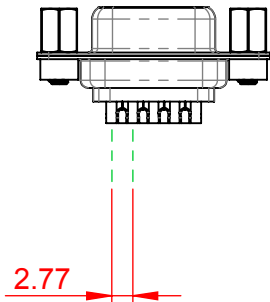

ISSUE NUMBER	
ORIGINAL	①

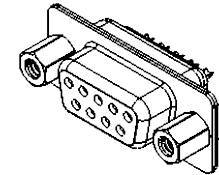
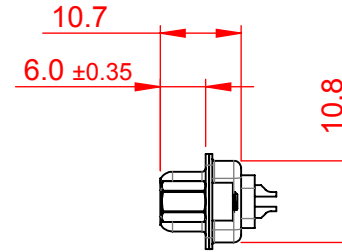
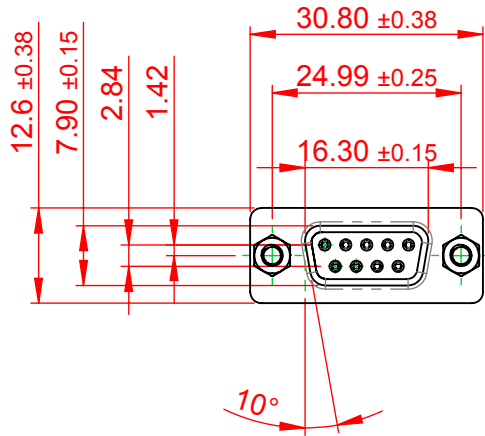

NOTES:

MATERIAL:

HOUSING: THERMOPLASTIC POLYESTER, UL94V-0

SHELL: STEEL, Sn or Ni PLATED

CONTACT: COPPER ALLOY SEE ORDERING GUIDE FOR PLATING

OPERATING TEMPERATURE: -55°C ~ 85°C

CURRENT RATING: 3A PER CONTACT

CONTACT RESISTANCE: 25mΩ MAX.

INSULATOR RESISTANCE: 5000MΩ min.

DIELECTRIC

WITHSTANDING VOLTAGE: 1000V AC rms



THIS SERIES FULLY CONFORMS TO
THE EUROPEAN UNION DIRECTIVES
2011/65/EU FOR RoHS COMPLIANCY.



YOUR CONNECTION TO QUALITY & SERVICE

EDAC INC
TORONTO, ONTARIO
CANADA

THESE DRAWINGS AND SPECIFICATIONS
ARE THE PROPERTY OF EDAC INC., AND
SHALL NOT BE REPRODUCED, OR COPIED
OR USED AS THE BASIS FOR THE
MANUFACTURE OR SALE OF APPARATUS
WITHOUT WRITTEN PERMISSION.

628 SERIES D-SUB CONNECTOR

SW REFERENCE NO.: 628 ASSEMBLY	
DRAWN: C.B	DATE: AUG. 01/2018
CHECKED:	DATE:
SCALE: 1:1	SHEET 1 OF 1
DRAWING NUMBER: 628-009-622-543	ISSUE
PART NUMBER: 628-009-622-543	1