

Data sheet | Item number: 787-785/000-040

Redundancy Module; 2 x 9 ... 54 VDC input voltage; 2 x 40 A input current; 9–54 VDC output voltage; 76 A output current

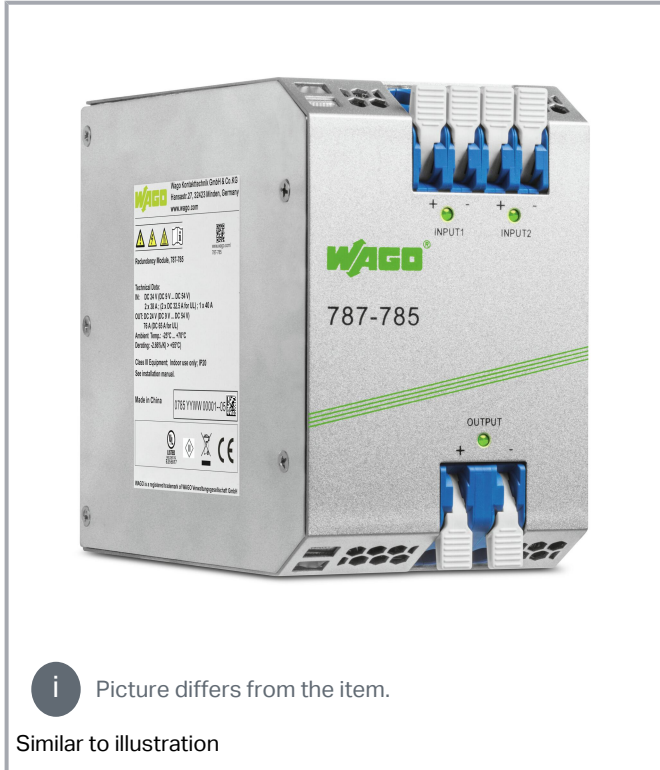

www.wago.com/787-785/000-040



i Picture differs from the item.

Similar to illustration

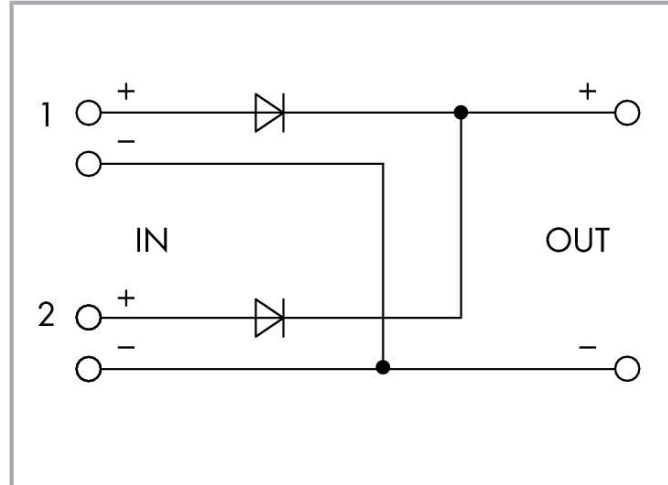

Item description

Features:

- Redundancy module with two inputs decouples two power supplies.
- For redundant and fail-safe power supply
- With LED for input voltage monitoring on site and remotely

Data

Technical data

Input

Nominal input voltage $U_{i\text{nom}}$

2 x DC 24 V

Subject to changes. Please also observe the further product documentation!

WAGO GmbH & Co. KG

Hansastr. 27

32423 Minden

Phone: +49571 887-0 | Fax: +49571 887-169

Email: info.de@wago.com | Web: www.wago.com

Do you have any questions about our products?

We are always happy to take your call at +49 (571) 887-44222.



Input voltage range	2 x DC 9 ... 54 V
Nominal mains frequency range	0 Hz
Input current I_i	≤ 40 A (per path); ≤ 76 A (in total)

Output

Nominal output voltage $U_{o\text{ nom}}$	DC 24 V
Output voltage range	DC 9 ... 54 V (U_e – voltage drop)
Voltage drop	≤ 500 mV (Input/output)
Nominal output current $I_{o\text{ nom}}$	40 A (redundancy operation); 65 A (parallel operation [UL]); 76 A (parallel operation)
Nominal output power	1824 W

Signaling and Communication

Signaling	1 x IN1 LED (green) 1 x IN2 LED (green) 1 x OUT LED (green)
Operation status indicator	2 x Green LED ($U_i > 7.5$ VDC) 1 x Green LED ($U_o > 7.5$ VDC)

Efficiency/power losses

Power loss P_i	≤ 38 W (nominal load)
Efficiency (typ.)	97 %

Safety and protection

Protection class	III
Protection type	IP20; per EN 60529
Pollution degree	2
Overvoltage protection; secondary	No
Short-circuit-protected	No
Open-circuit-proof	Yes
Parallel operation	Yes
Series operation	No
MTBF	> 10 million h (per IEC 61709)

Subject to changes. Please also observe the further product documentation!



Connection data

Connection type 1	Input/output
Connection technology	Push-in CAGE CLAMP®
WAGO connector	WAGO 2716 Series
Solid conductor	1.5 ... 16 mm ² / 16 ... 6 AWG
Fine-stranded conductor	1.5 ... 16 mm ² / 16 ... 6 AWG
Strip length	12 ... 13 mm / 0.47 ... 0.51 inches

Physical data

Width	83 mm / 3.268 inches
Height	130 mm / 5.118 inches
Depth from upper-edge of DIN-rail	153 mm / 6.024 inches

Mechanical Data

Mounting type	DIN-35 rail
---------------	-------------

Material Data

Weight	960 g
--------	-------

Environmental requirements

Ambient temperature (operation)	-25 ... +70 °C
Ambient temperature (storage)	-40 ... +85 °C
Relative humidity	95% (no condensation permissible)
Derating	-2.66 %/K (55 °C < T _u ≤ 70 °C)
Resistance to shock and vibration	Shock: 15g (per EN 60068-2-27)

Standards and specifications

Conformity marking	CE
Standards/specifications	UL 508 ATEX IEC Ex ANSI/ISA 12.12.01 (Class I Div. 2)

Subject to changes. Please also observe the further product documentation!

Commercial data



ETIM 8.0	EC002540
ETIM 7.0	EC002540
PU (SPU)	1 pcs
Packaging type	Box
Country of origin	CN
GTIN	4055143889704
Customs tariff number	85044083900

Environmental Product Compliance



RoHS Compliance Status	Compliant, No Exemption
------------------------	-------------------------

Approvals / Certificates

General approvals

Logo	Approval	Additional Approval Text	Certificate name
	CCC CNEX	CNCA-C23-01	2020312303000474 (Ex ec IIC T4 Gc)
	UL Underwriters Laboratories Inc.	ANSI/ISA 12.12.01	E484199
	UL Underwriters Laboratories Inc.	UL 508	E255817

Declarations of conformity and manufacturer's declarations





Logo	Approval	Additional Approval Text	Certificate name
	EU-Declaration of Conformity WAGO GmbH & Co. KG	-	-
	UK-Declaration of Conformity WAGO GmbH & Co. KG	-	-

Subject to changes. Please also observe the further product documentation!



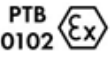



WAGO GmbH & Co. KG
Hansastr. 27
32423 Minden
Phone: +49571 887-0 | Fax: +49571 887-169
Email: info.de@wago.com | Web: www.wago.com

Do you have any questions about our products?
We are always happy to take your call at +49 (571) 887-44222.















Approvals for hazardous areas

Logo	Approval	Additional Approval Text	Certificate name
	ATEX DEKRA EXAM GmbH	EN 60079-0	BVS 17 ATEX E 010 X (II 3 G Ex ec IIC T4 Gc)
	CCC CNEX	CNCA-C23-01	2020312303000474 (Ex ec IIC T4 Gc)
	EAC Brjansker Zertifizierungsstelle	TP TC 012/2011	EAC RU C-DE.AM02. B.00132/19 (2Ex e IIC T4 Gc X)
	IECEX DEKRA EXAM GmbH	IEC 60079-0	IECEX_BVS_17. 0003X_Issue_02 (Ex ec IIC T4 Gc)
	UKEx WAGO GmbH	EN 60079-0	WAGO22UKEX006X

Optional accessories

Ferrule		
Ferrule		
	Item no.: 216-203 Ferrule; Sleeve for 1 mm ² / AWG 18; insulated; electro-tin plated; red	www.wago.com/216-203
	Item no.: 216-206 Ferrule; Sleeve for 2.5 mm ² / AWG 14; insulated; electro-tin plated; blue	www.wago.com/216-206
	Item no.: 216-207 Ferrule; Sleeve for 4 mm ² / AWG 12; insulated; electro-tin plated; gray	www.wago.com/216-207
	Item no.: 216-202 Ferrule; Sleeve for 0.75 mm ² / 18 AWG; insulated; electro-tin plated; gray	www.wago.com/216-202
	Item no.: 216-204 Ferrule; Sleeve for 1.5 mm ² / AWG 16; insulated; electro-tin plated; black	www.wago.com/216-204
	Item no.: 216-209 Ferrule; Sleeve for 10 mm ² / AWG 8; insulated; electro-tin plated; red	www.wago.com/216-209

Subject to changes. Please also observe the further product documentation!

	Item no.: 216-205 Ferrule; Sleeve for 2.08 mm ² / AWG 14; insulated; electro-tin plated; yellow	www.wago.com/216-205
	Item no.: 216-208 Ferrule; Sleeve for 6 mm ² / AWG 10; insulated; electro-tin plated; electrolytic copper; gastight crimped; acc. to DIN 46228, Part 4/09.90; yellow	www.wago.com/216-208
	Item no.: 216-201 Ferrule; Sleeve for 0.5 mm ² / 20 AWG; insulated; electro-tin plated; white	www.wago.com/216-201
	Item no.: 216-224 Ferrule; Sleeve for 1.5 mm ² / AWG 16; insulated; electro-tin plated; black	www.wago.com/216-224
	Item no.: 216-244 Ferrule; Sleeve for 1.5 mm ² / AWG 16; insulated; electro-tin plated; electrolytic copper; gastight crimped; acc. to DIN 46228, Part 4/09.90; black	www.wago.com/216-244
	Item no.: 216-246 Ferrule; Sleeve for 2.5 mm ² / AWG 14; insulated; electro-tin plated; electrolytic copper; gastight crimped; acc. to DIN 46228, Part 4/09.90; blue	www.wago.com/216-246
	Item no.: 216-266 Ferrule; Sleeve for 2.5 mm ² / AWG 14; insulated; electro-tin plated; electrolytic copper; gastight crimped; acc. to DIN 46228, Part 4/09.90; blue	www.wago.com/216-266
	Item no.: 216-264 Ferrule; Sleeve for 1.5 mm ² / AWG 16; insulated; electro-tin plated; electrolytic copper; gastight crimped; acc. to DIN 46228, Part 4/09.90; black	www.wago.com/216-264
	Item no.: 216-284 Ferrule; Sleeve for 1.5 mm ² / AWG 16; insulated; electro-tin plated; electrolytic copper; gastight crimped; acc. to DIN 46228, Part 4/09.90; black	www.wago.com/216-284
	Item no.: 216-286 Ferrule; Sleeve for 2.5 mm ² / AWG 14; insulated; electro-tin plated; electrolytic copper; gastight crimped; acc. to DIN 46228, Part 4/09.90; blue	www.wago.com/216-286
	Item no.: 216-287 Ferrule; Sleeve for 4 mm ² / AWG 12; insulated; electro-tin plated; electrolytic copper; gastight crimped; acc. to DIN 46228, Part 4/09.90; gray	www.wago.com/216-287
	Item no.: 216-288 Ferrule; Sleeve for 6 mm ² / AWG 10; insulated; electro-tin plated; electrolytic copper; gastight crimped; acc. to DIN 46228, Part 4/09.90; yellow	www.wago.com/216-288
	Item no.: 216-289 Ferrule; Sleeve for 10 mm ² / AWG 8; insulated; electro-tin plated; electrolytic copper; gastight crimped; acc. to DIN 46228, Part 4/09.90; red	www.wago.com/216-289
	Item no.: 216-267 Ferrule; Sleeve for 4 mm ² / AWG 12; insulated; electro-tin plated; electrolytic copper; gastight crimped; acc. to DIN 46228, Part 4/09.90; gray	www.wago.com/216-267

Downloads

Documentation

Bid Text

787-785/000-040

2019 Aug 23

xml

Download

Subject to changes. Please also observe the further product documentation!

WAGO GmbH & Co. KG

Hansastr. 27

32423 Minden

Phone: +49571 887-0 | Fax: +49571 887-169

Email: info.de@wago.com | Web: www.wago.com

Do you have any questions about our products?

We are always happy to take your call at +49 (571) 887-44222.



X81 - Datei			6.3 kB	
-------------	--	--	--------	--

787-785/000-040 docx - Datei	2019 Aug 23	docx 22.7 kB		Download
---------------------------------	-------------	-----------------	--	----------

Instruction Leaflet

CCC Ex (Additional information) 787-783*, 787-785*	2023 Apr 26	pdf 137.9 kB		Download
---	-------------	-----------------	--	----------

Diode Redundancy Module DC 24 V, 40 A	V 1.2.0 2021 Sep 29	pdf 3.9 MB		Download
--	------------------------	---------------	--	----------

Additional Information

Disposal and Recycling Electrical and electronic equipment, Batteries, Packaging	V 1.1.0 2022 Aug 18	pdf 2.2 MB		Download
---	------------------------	---------------	--	----------

Environmental Product Compliance

Compliance Search

Environmental Product Compliance 787-785/000-040 Redundancy Module; 2 x 9 ... 54 VDC input voltage; 2 x 40 A input current; 9-54 VDC output voltage; 76 A output current		URL		Download
--	--	-----	--	----------

Installation Notes

Subject to changes. Please also observe the further product documentation!