

8 Series Pushbutton Switches

■ Features

- 1. Contacts**
Silver or gold-plated contacts.
- 2. Epoxy resin case**
UL94V-0 self-extinguishing epoxy.
- 3. Actuator style**
Over 30 actuator variations.
- 4. Insulation between terminal and ground:
4 mm minimum.**
- 5. Prevention of flux entry**
The epoxy resin seal on bottom of the switch helps prevent the entry of solder and flux.
- 6. Insulation barrier:**
Insulation barrier design between poles helps prevent short-circuiting between poles ensuring high reliability.

■ Specifications

Rating	Max. rating	6A 125VAC/3A 250VAC/4A 30VDC	
Initial contact resistance	10mΩmax. (1A 2~4VDC)		
Initial dielectric strength	1,500VAC 1 minute		
Initial insulation resistance	1,000MΩ min. (500VDC)		
Electrical life (Excluding 8R & 8W)	Alternate type	40,000 operations	
	Momentary type	25,000 operations	
Operating temperature range	-30°C~+85°C		
Storage temperature range	-40°C~+85°C		

(Excluding **8R** & **8W**. Specifications on 8R and 8W series are specified separately on P.264 and P.269.)

■ Terminal Styles

Solder (Style:1)	Straight (Style:2)
<p>t=0.8</p>	<p>t=0.8</p>

UL-Recognized, CSA certified Products
(Pushbutton type Only)

■ Eight Switch Series







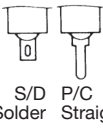

Poles	Switching function	UL (※2.)			CSA (※3.)		
		8N	8P	8Y	8N	8P	8Y
1 pole	1011-Z ON - ON	○	○	○	○	○	○
	1012-Z ON - ON	○	○	○	○	○	○
	1021-Z ON - (ON)	○	○	○	○	○	○
	1022-Z ON - (ON)	○	○	○	○	○	○
2 poles	2011-Z ON - ON	○	○	○	○	○	○
	2012-Z ON - ON	○	○	○	○	○	○
	2021-Z ON - (ON)	○	○	○	○	○	○
	2022-Z ON - (ON)	○	○	○	○	○	○
3 poles	3011-Z ON - ON	○	○	○	○	○	○
	3021-Z ON - (ON)	○	○	○	○	○	○
4 poles	4011-Z ON - ON	○	○	○	○	○	○
	4021-Z ON - (ON)	○	○	○	○	○	○

(※2.) **UL File No.E43275**

(※3.) **CSA File No.LR38341**

If **UL** or **CSA** marking is required, please specify when ordering.

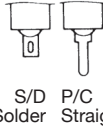
8 Series Pushbutton Switches Selection Table

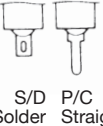
Part No.	Name	Actuator shape	Number of poles	Switching function	Terminal style	Page
8N	Standard Pushbutton		1.2.3.4	ON — ON ON — (ON)	 S/D Solder P/C Straight	261
8P	Splash Proof Pushbutton		1.2	ON — ON ON — (ON)	 S/D Solder	263
8Y	Mustang Pushbutton		1.2.3	ON — ON ON — (ON)	 S/D Solder	265
8R-N	Soft Touch Pushbutton		1.2	ON — ON ON — (ON)	 S/D Solder P/C Straight	267
8W-N	Snap-in Pushbutton		1.2	ON — (ON)	 S/D Solder P/C Straight	269

Part Numbering

8

Series code

N

Actuator shape

1

Number of poles

01

Switching function

1

Terminal style

B — Z

(※1) Contact plating and material

Code	Actuator
N	Standard
P	Splash proof
Y	Mustang
R	Soft Touch
W	Snap-in

Fig.	Number of poles
1	1
2	2
3	3
4	4

Fig.	Switching function
01	ON — ON
02	ON — (ON)

Fig.	Terminal style
1	Solder
2	PC/Straight

Code	Contact material	Plating
None	Bs+Ag or Cu+Ag	Ag
B	Bs or Cu	Ni+Au
C	Bs+Ag or Cu+Ag	Ni+Au

※1 Bs= Brass
Cu= Copper
Ag= Silver
Ni= Nickel
Au= Gold

Note : Some combinations may not be available. Please check the "Table of Part Numbers" for each series.

8P

Splash Proof Pushbutton Switches

Panel Seal

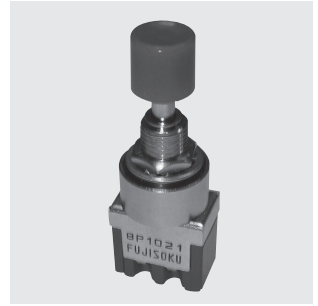

RoHS Compliant

■ Features

The 8P series is a panel seal pushbutton switch with an O-ring to provide drip-proof and dust proof effect (corresponding to IP67 rating). Since a locking ring cannot be used because the panel seal is required, "D-cutting" is provided to the sleeve to prevent the switch from rotating. Note that the switch can also be mounted to a 6.5 mm dia. round hole instead of a "D-cut" hole without losing the drip-proof and dust proof effect.

■ Table of Part Numbers

Terminal style	No. of pole Switching function	1 pole	2 poles
		ON - ON	8P1011-Z
Solder Lug	ON - (ON)	8P1021-Z ☆ 8P1021C-Z	8P2021-Z ▲ 8P2021C-Z

■ PC Hole Layouts ————— Page 271.

■ Panel Cut-Out Dimensions ————— Page 271.

■ Standard Accessories

《Supplied with switch》

Hex Nut	Lockwasher	O-Ring
140008010241	140008030051	140000610076
Nickel plated	Zinc plated	Nitrile rubber (Black)

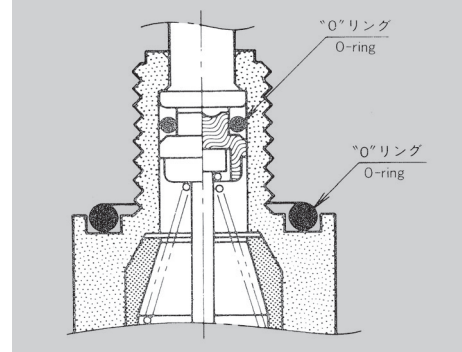

The 8P series is intended for panel seal and is not designed for use in water.

Part name	Color Button			
Dimension A	φ8	φ10	φ15	
Dimension B	7.5	8	10	
	White	140000481420	140000480082	140000480088
	Red	140000481421	140000480083	140000480089
	Black	140000481422	140000480081	140000480090
	Gray	140000481423	140000480084	140000480091

★ : Made to order products.

☆ : Semi-standard products.

(ON) : Momentary.

▲ : Inquiry products.

● A Hex Nut, a Lockwasher, and an O-ring are supplied with the switch. A Color Button is also supplied with the switch. Please specify the part number from the above table when ordering.

Color Button Installation

Snap in the color button on to the actuator.

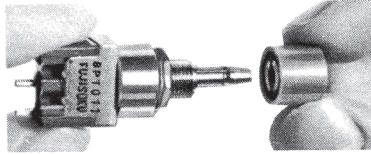

SPDT

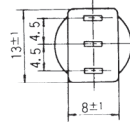
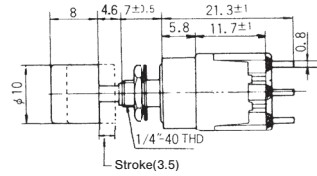
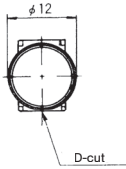
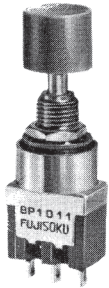

Switching function		
Part No.		
※ 8P101■-Z	ON	ON
8P102■-Z	ON	(ON)
Connecting terminals	2-3	2-1

※ : The circuit switches each time the switch button is pressed.

■ : Please refer to "Table of Part Numbers" on P.263 for a list of full part numbers.

Terminal numbers are not shown on the switch.

DPDT

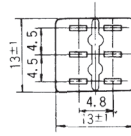
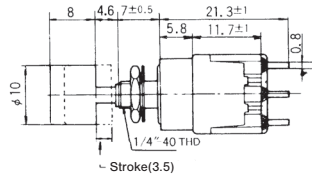
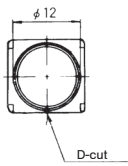
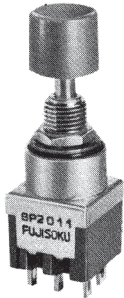

Switching function		
Part No.		
※ 8P201■-Z	ON	ON
8P202■-Z	ON	(ON)
Connecting terminals	2-3 5-6	2-1 5-4

※ : The circuit switches each time the switch button is pressed.

■ : Please refer to "Table of Part Numbers" on P.263 for a list of full part numbers.

Terminal numbers are not shown on the switch.

Panel Cut-Out Dimensions

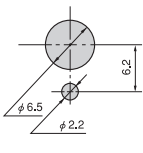
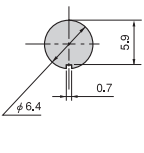
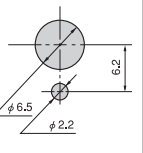
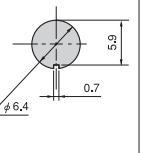
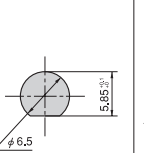
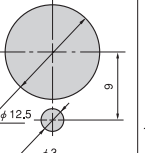
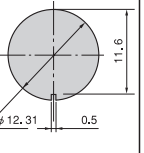
Series	8N		8R		8P	8Y	
Panel thickness	1.5 mm Max.	2.5 mm Max.	2 mm Max.	3 mm Max.	4.5 mm Max.	5 mm Max.	6 mm Max.
Dimensions	 With Locking Ring	 Without Locking Ring	 With Locking Ring	 Without Locking Ring	 With Locking Ring	 With Locking Ring	 Without Locking Ring

PC Hole Layouts

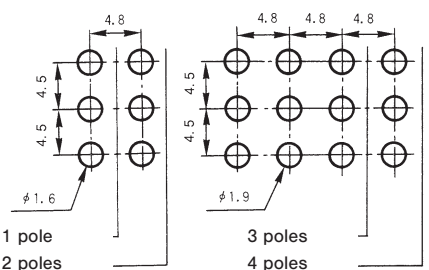
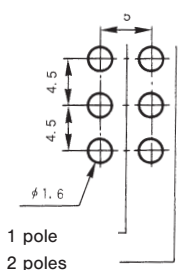
Series	8N • 8P	8R • 8W
Dimensions	 <p>1 pole 2 poles</p> <p>3 poles 4 poles</p>	 <p>1 pole 2 poles</p>

Precautions (8N•8P•8R•8W•8Y)

1. Soldering Specifications

(1)Manual soldering

Device : Solder iron

①420°C Max. 3 sec. Max.

(2)Auto soldering

②275°C ±10°C 5 sec. Max.

The above-stated soldering conditions shall apply only to switches with straight terminals. Auto soldering is not possible with right-angle terminals. Switches with right-angle terminals should be soldered manually according to the conditions specified in (1) above.

(3)When putting the switches through an aging process after they were soldered onto the printing board or after installed into a complete end product, be sure to remove the buttons ofthe switches.,

2. Mounting

- Do not bend the terminals before mounting the switch on the PC board.
- After mounting the switch, do not place the device in such a way that the device weight will be applied on to the actuator of the switch.
- For switches with straight terminals, solder the switch on the PC board after fixing the switch on the panel with a nut.

3. Flux Cleaning

(1)Solvent : Fluorine or Alcohol type.

(2)8A/B/C/D/E/F/J/S series are not washable. To wash the PC board, clean the soldering surface of the PC board with a brush so that the switch is not exposed to the cleaning solution.

Packaging Specification

