

Features

- Glass passivated junction chip
- For surface mounted application
- Low forward voltage drop
- Low profile package
- Built-in stain relief, ideal for automated placement
- Fast switching for high efficiency
- Plastic package has Underwriters Laboratory Flammability Classification 94V-0



DO-214AC (SMA)

Typical Applications

For use of general purpose rectification in lighting, cellular phone, portable device, power supplies and other consumer applications.

Maximum Ratings (TA = 25 °C unless otherwise noted)										
Parameter	Symbol	HS2AA	HS2BA	HS2DA	HS2FA	HS2GA	HS2JA	HS2KA	HS2MA	Unit
Maximum repetitive peak reverse voltage	V _{RRM}	50	100	200	300	400	600	800	1000	V
Maximum RMS voltage	V _{RMS}	35	70	140	210	280	420	560	700	V
Maximum DC blocking voltage	V _{DC}	50	100	200	300	400	600	800	1000	V
Maximum average output rectified current	I _{F(AV)}	1.5								A
Peak forward surge current 8.3 ms single half sine-wave superimposed on rated load	I _{FSM}	50								A
Rating for fusing(t<8.3ms)	I ² t	10								A ² sec
Operating junction and storage temperature range	T _J , T _{STG}	-55 to +150								°C

Electrical Characteristics (TA = 25 °C unless otherwise noted)											
Parameter	Test Conditions	Symbol	HS2AA	HS2BA	HS2DA	HS2FA	HS2GA	HS2JA	HS2KA	HS2MA	Unit
Maximum instantaneous forward voltage	I _F =1.5A T _A =25°C	V _F	1.0				1.3	1.7			Volts
Maximum DC reverse current at rated DC blocking voltage	T _A =25°C T _A =125°C	I _R	5.0				100				µA
Maximum reverse recovery time	I _F =0.5A, I _R =1.0A, I _{RR} =0.25A	t _{rr}	50				75				nS
Typical junction capacitance	4.0 V, 1 MHz	C _J	50				30				pF

Thermal Characteristics										
Parameter	Symbol	HS2AA	HS2BA	HS2DA	HS2FA	HS2GA	HS2JA	HS2KA	HS2MA	Unit
Typical thermal resistance ⁽¹⁾	R _{θJA}	67								°C/W
	R _{θJC}	27								
	R _{θJL}	7								

Notes:1. The thermal resistance from junction to ambient,case or mount,mounted on P.C.B with 5×5mm copper pads,2 OZ,FR4 PCB

Ratings and Characteristics Curves

(TA = 25°C unless otherwise noted)

FIG.1- REVERSE RECOVERY TIME CHARACTERISTIC AND TEST CIRCUIT DIAGRAM

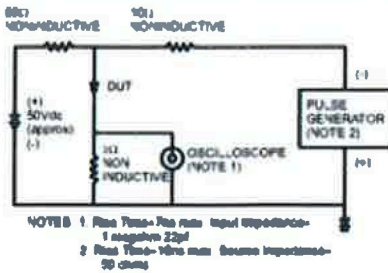

FIG.2- MAXIMUM FORWARD CURRENT DERATING CURVE

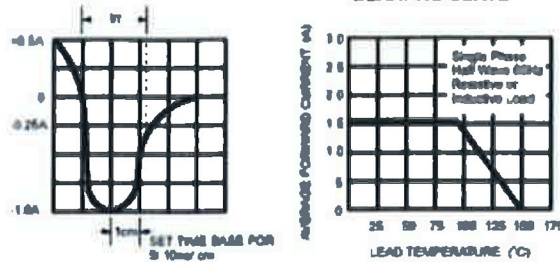

FIG.3- TYPICAL REVERSE CHARACTERISTICS

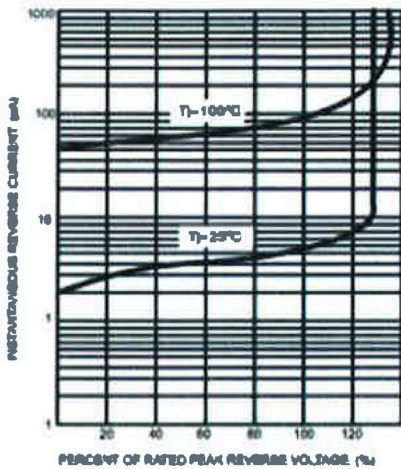

FIG.4- TYPICAL INSTANTANEOUS FORWARD CHARACTERISTICS

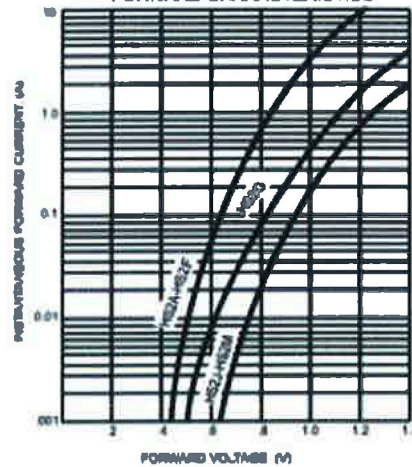

FIG.5- MAXIMUM NON-REPETITIVE FORWARD SURGE CURRENT

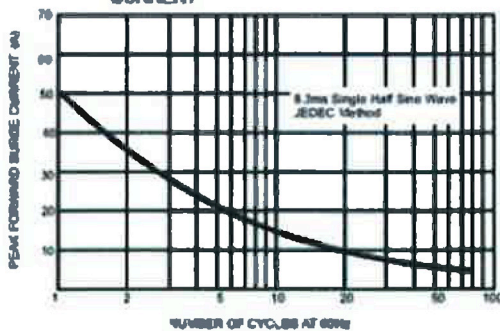
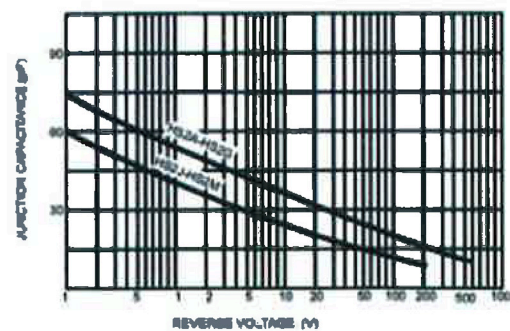
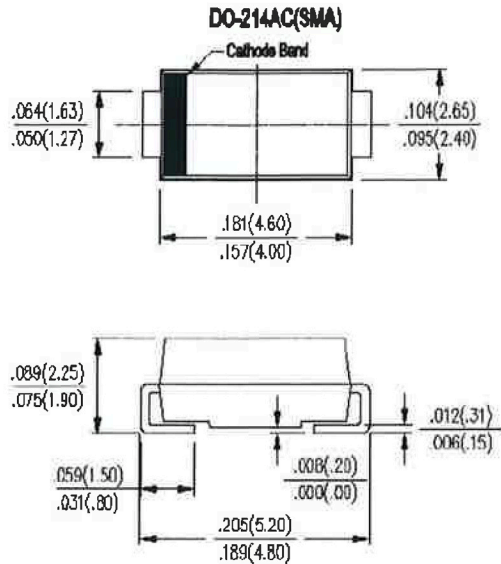

FIG.6- TYPICAL JUNCTION CAPACITANCE



Package Outline Dimensions



MOUNTING PAD LAYOUT

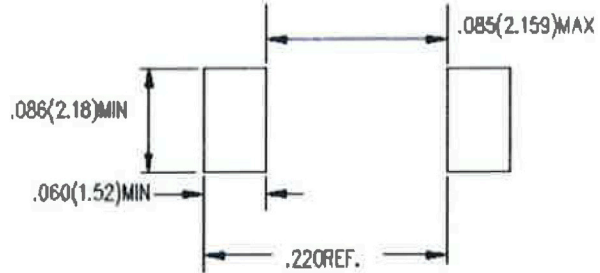

Packing Information

7500 pcs/Reel, 18 Reels/Box; 12mm Tape, 13" Reel

Tape & Reel Specification

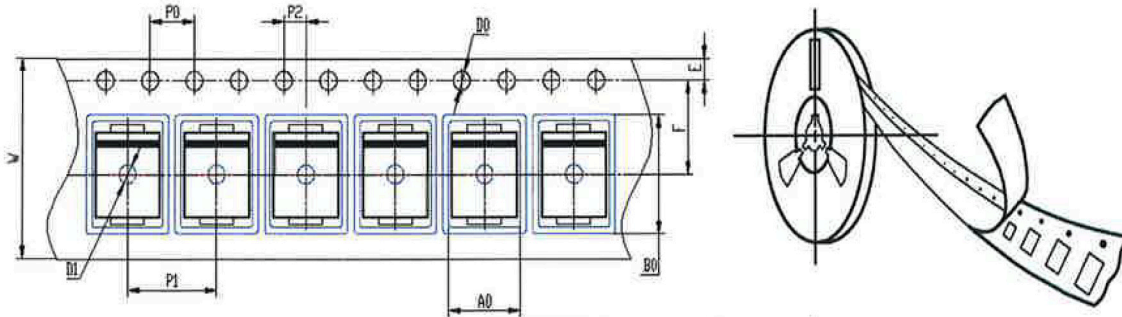

Symbol	SMA (mm)
W	12 ± 0.2
E	1.75 ± 0.1
F	5.5 ± 0.05
D0	1.5 ± 0.1
D1	1.50 +0.1/-0
P0	4.0 ± 0.1
P1	4.0 ± 0.1
P2	2.0 ± 0.05
A0	2.65 ± 0.1
B0	5.25 ± 0.1

Soldering Parameters

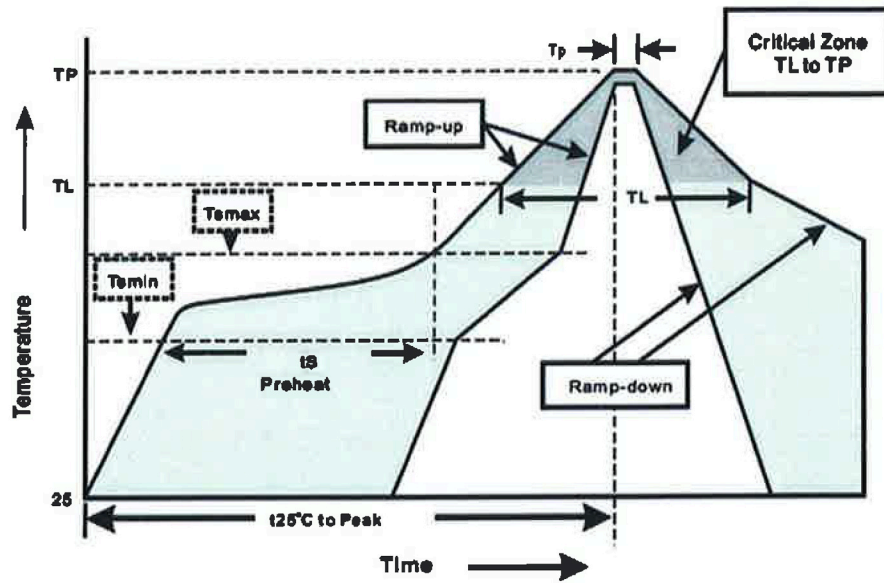

Reflow Soldering		Sn-Pb Eutectic Assembly	Pb-Free assembly
Pre Heat	- Temperature Min (Ts(min))	100°C	150°C
	- Temperature Max (Ts(max))	150°C	200°C
	- Time (min to max) (ts)	60 – 120 secs	60 – 180 secs
Average ramp up rate (Liquidus Temp (TL) to peak)		3°C/second max	3°C/second max
TS(max) to TL - Ramp-up Rate		3°C/second max	3°C/second max
Reflow	- Temperature (TL) (Liquidus)	183°C	217°C
	- Time (min to max) (ts)	60 – 150 seconds	60 – 150 seconds
Peak Temperature (TP)		240+0/-5 °C	240+0/-5°C
Time within 5°C of actual peak Temperature (tp)		10 –30 seconds	20 – 40 seconds
Ramp-down Rate		6°C/second max	6°C/second max
Time 25°C to peak Temperature (TP)		6 minutes Max.	8 minutes Max.
Do not exceed		260°C	260°C

Wave Soldering	
Peak Temperature :	260+0/-5°C
Dipping Time :	10 seconds
Soldering :	1 time