



MZT7-03VPO-KP0

MZT7

SENSORS FOR T-SLOT CYLINDERS

SICK
Sensor Intelligence.



Ordering information

Type	Part no.
MZT7-03VPO-KPO	1070818

Other models and accessories → www.sick.com/MZT7



Detailed technical data

Features

Cylinder type	T-slot
Cylinder types with adapter	Profile cylinder Tie rod cylinder Round body cylinder Dovetail groove cylinder SMC rail CDQ2 SMC rail ECDQ2
Housing length	29,5 mm
Switching output	PNP
Switching frequency	1,000 Hz
Output function	NC
Electrical wiring	DC 3-wire
Enclosure rating	IP65 ¹⁾ IP67

¹⁾ According to EN 60529.

Mechanics/electronics

Supply voltage	10 V DC ... 30 V DC
Power consumption	8 mA, without load
Voltage drop	≤ 2 V
Continuous current I_a	≤ 100 mA
Protection class	III
Response sensitivity, typ.	3 mT
Overrun distance, typ.	10 mm
Hysteresis, typ.	< 0.8 mT
Reproducibility	≤ 0.1 mT ¹⁾
Reverse polarity protection	Yes
Short-circuit protection	Yes

¹⁾ U_b and T_a constant.

Status indicator LED	Yes
Ambient operating temperature	-30 °C ... +80 °C
Shock and vibration resistance	30 g, 11 ms / 10 ... 55 Hz, 1 mm
EMC	According to EN 60947-5-2
Connection type	Cable with connector M8, 3-pin, drag chain use, 0.3 m
Connection type Detail	
Conductor cross section	0.14 mm ²
Cable diameter	Ø 2.9 mm
Bending radius	With fixed installation > 8 x cable diameter For flexible use > 12 x cable diameter
Cable outlet	Axial
Material	
Housing	Plastic
Cable	PUR
UL File No.	NRKH.E181493 & NRKH7.E181493

¹⁾ Ub and Ta constant.

Safety-related parameters

MTTF_D	1,300 years
DC_{avg}	0 %
T_M (mission time)	20 years

Classifications

eCl@ss 5.0	27270104
eCl@ss 5.1.4	27270104
eCl@ss 6.0	27270104
eCl@ss 6.2	27270104
eCl@ss 7.0	27270104
eCl@ss 8.0	27270104
eCl@ss 8.1	27270104
eCl@ss 9.0	27270104
eCl@ss 10.0	27270104
eCl@ss 11.0	27270104
eCl@ss 12.0	27274301
ETIM 5.0	EC002544
ETIM 6.0	EC002544
ETIM 7.0	EC002544
ETIM 8.0	EC002544
UNSPSC 16.0901	39122230

Installation note



Connection diagram

Cd-004

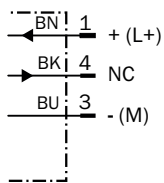

Dimensional drawing (Dimensions in mm (inch))

Cable with connector M8

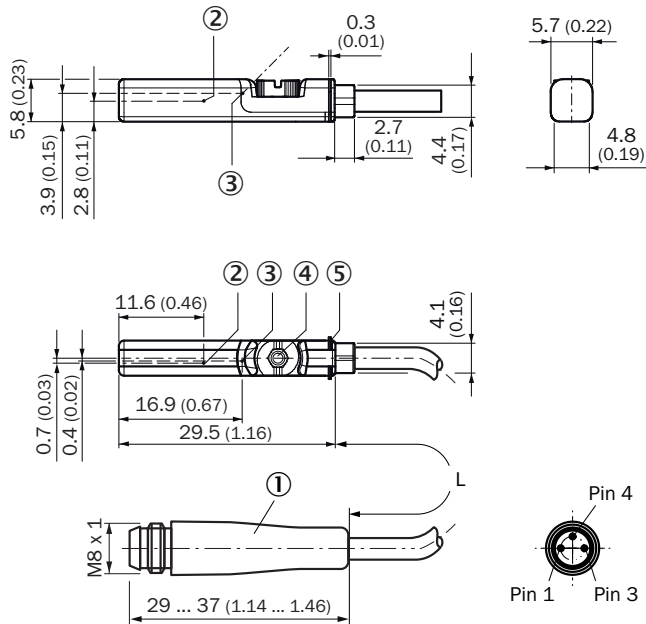







- ① Connection
- ② Position sensor element
- ③ Display LED
- ④ Fixing screw SW 2.5
- ⑤ Retaining ribs













Part no.	Type	L	Number of cores
1104369	MZT7-03VPS-KPD	250 mm	3

Part no.	Type	L	Number of cores
1070814	MZT7-03VPS-KPO	300 mm	3
1070818	MZT7-03VPO-KPO	300 mm	3
1070819	MZT7-03VNS-KPO	300 mm	3
1070820	MZT7-03VNO-KPO	300 mm	3

Recommended accessories

Other models and accessories → www.sick.com/MZT7

	Brief description	Type	Part no.
Brackets for cylinder sensors			
	Mounting bracket for cylinder with dovetail slot, Aluminum, without mounting hardware	BEF-KHZ-ST1	2022703
	Mounting bracket for integrated profile cylinder/tie-rod cylinder, zinc diecast, mounting hardware included	BEF-KHZ-PT1	2022702
	1 piece, Mounting bracket on round body cylinder with piston diameter of 12 mm, ambient temperature min 0 °C max 50 °C, plastic, Aluminum	BEF-KHZ-RT-12	2077681
	1 piece, Mounting bracket on round body cylinder with piston diameter of 16 mm, ambient temperature min 0 °C max 50 °C, plastic, Aluminum	BEF-KHZ-RT-16	2077680
	1 piece, Mounting bracket on round body cylinder with piston diameter of 20 mm, ambient temperature min 0 °C max 50 °C, plastic, Aluminum	BEF-KHZ-RT-20	2077679
	1 piece, Mounting bracket on round body cylinder with piston diameter of 25 mm, ambient temperature min 0 °C max 50 °C, plastic, Aluminum	BEF-KHZ-RT-25	2077678
	1 piece, Mounting bracket on round body cylinder with piston diameter of 32 mm, ambient temperature min 0 °C max 50 °C, plastic, Aluminum	BEF-KHZ-RT-32	2077677
	1 piece, Mounting bracket on round body cylinder with piston diameter of 40 mm, ambient temperature min 0 °C max 50 °C, plastic, Aluminum	BEF-KHZ-RT-40	2077676
	1 piece, Mounting bracket on round body cylinder with piston diameter of 50 mm, ambient temperature min 0 °C max 50 °C, plastic, Aluminum	BEF-KHZ-RT-50	2077675
	1 piece, Mounting bracket on round body cylinder with piston diameter of 63 mm, ambient temperature min 0 °C max 50 °C, plastic, Aluminum	BEF-KHZ-RT-63	2077674
		1 piece, Mounting bracket on round body cylinder with piston diameter of 8 mm ... 130 mm, ambient temperature min -30 °C max 80 °C, stainless steel, Zinc cast	BEF-KHZ-RT1-130
1 piece, Mounting bracket on round body cylinder with piston diameter of 8 mm ... 25 mm, ambient temperature min -30 °C max 80 °C, stainless steel, Zinc cast		BEF-KHZ-RT1-25	2077682
1 piece, Mounting bracket on round body cylinder with piston diameter of 8 mm ... 63 mm, ambient temperature min -30 °C max 80 °C, stainless steel, Zinc cast		BEF-KHZ-RT1-63	2077683
	Mounting bracket for mounting on SMC rails CDQ2 (T-slot), Aluminum, without mounting hardware	BEF-KHZ-TT2	2046440
	Mounting bracket for mounting on SMC rails ECDQ2 (T-slot), Aluminum, without mounting hardware	BEF-KHZ-TT1	2046439

	Brief description	Type	Part no.
Device protection (mechanical)			
	Protective adapter, die-cast zinc, mounting hardware included	BEF-SG-MRZT	2077201
Plug connectors and cables			
	Head A: female connector, M8, 3-pin, straight, A-coded Head B: Flying leads Cable: Sensor/actuator cable, PUR, halogen-free, unshielded, 2 m	YF8U13-020UA1XLEAX	2094782
	Head A: female connector, M8, 3-pin, straight, A-coded Head B: Flying leads Cable: Sensor/actuator cable, PVC, unshielded, 2 m	YF8U13-020VA1XLEAX	2095860
	Head A: female connector, M8, 3-pin, straight, A-coded Head B: Flying leads Cable: Sensor/actuator cable, PUR, halogen-free, unshielded, 3 m	YF8U13-030UA1XLEAX	2094787
	Head A: female connector, M8, 3-pin, straight, A-coded Head B: Flying leads Cable: Sensor/actuator cable, PUR, halogen-free, unshielded, 5 m	YF8U13-050UA1XLEAX	2094788
	Head A: female connector, M8, 3-pin, straight, A-coded Head B: Flying leads Cable: Sensor/actuator cable, PVC, unshielded, 5 m	YF8U13-050VA1XLEAX	2095884
	Head A: female connector, M8, 3-pin, angled, A-coded Head B: Flying leads Cable: Sensor/actuator cable, PUR, halogen-free, unshielded, 2 m	YG8U13-020UA1XLEAX	2094794
	Head A: female connector, M8, 3-pin, angled, A-coded Head B: Flying leads Cable: Sensor/actuator cable, PVC, unshielded, 2 m	YG8U13-020VA1XLEAX	2096165
	Head A: female connector, M8, 3-pin, angled, A-coded Head B: Flying leads Cable: Sensor/actuator cable, PVC, unshielded, 5 m	YG8U13-050VA1XLEAX	2096166
	Head A: female connector, M8, 3-pin, straight Cable: unshielded	DOS-0803-G	7902077
	Head A: female connector, M8, 3-pin, angled Cable: unshielded	DOS-0803-W	7902078
	Head A: male connector, M8, 3-pin, straight Cable: unshielded	STE-0803-G	6037322

SICK AT A GLANCE

SICK is one of the leading manufacturers of intelligent sensors and sensor solutions for industrial applications. A unique range of products and services creates the perfect basis for controlling processes securely and efficiently, protecting individuals from accidents and preventing damage to the environment.

We have extensive experience in a wide range of industries and understand their processes and requirements. With intelligent sensors, we can deliver exactly what our customers need. In application centers in Europe, Asia and North America, system solutions are tested and optimized in accordance with customer specifications. All this makes us a reliable supplier and development partner.

Comprehensive services complete our offering: SICK LifeTime Services provide support throughout the machine life cycle and ensure safety and productivity.

For us, that is “Sensor Intelligence.”

WORLDWIDE PRESENCE:

Contacts and other locations –www.sick.com