

**Mounting Option**

.128 (3.25) Dia. Mounting Holes

**Contact Detail**

90 Degree Bend (Code 522 and 540 Contacts)

.156 [3.96] Contact Spacing x .200 [5.08] Row Spacing

THIS IS A C.A.D. GENERATED DRAWING  
DO NOT MAKE MANUAL REVISIONS TO MASTER.



ISSUE NUMBER

ORIGINAL

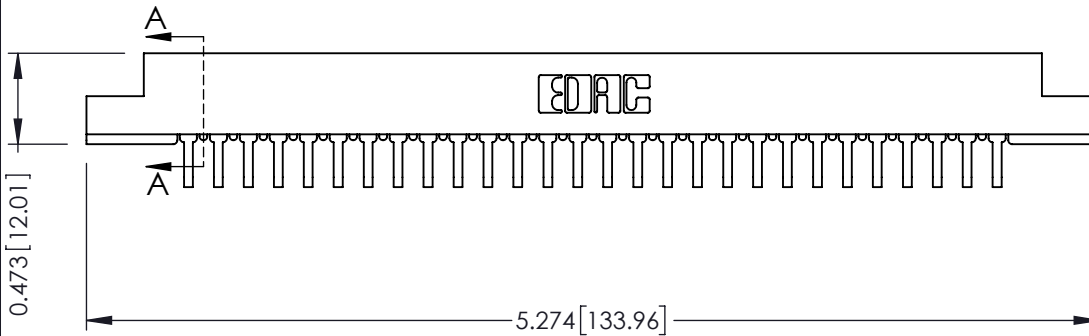
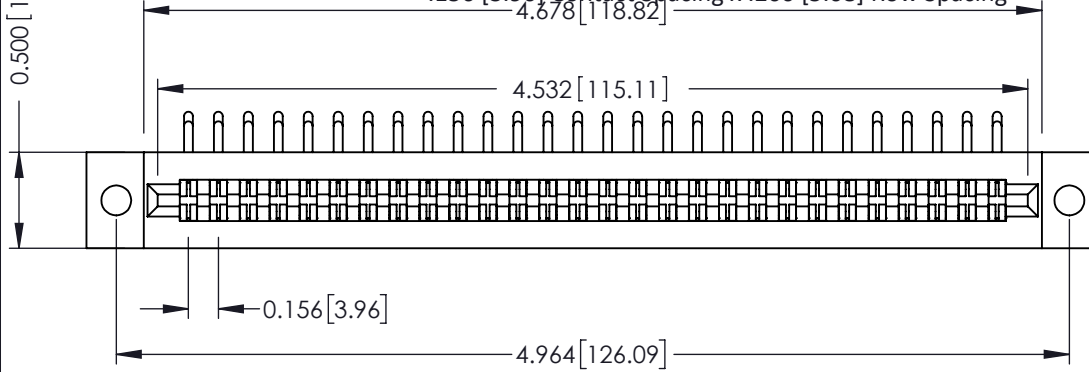

**SECTION A-A**

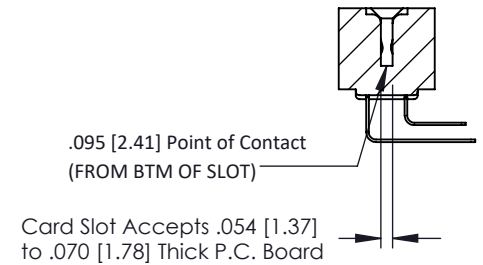

**See Accompanying Pages for:**

- Contact Bend Details
- Mounting Options

307 / 357 Card Edge Connector

Part Number: 307-056-559-202



EDAC INC  
TORONTO, ONTARIO  
CANADA

YOUR CONNECTION TO QUALITY & SERVICE

THESE DRAWINGS AND SPECIFICATIONS ARE THE PROPERTY OF EDAC INC. AND SHALL NOT BE REPRODUCED, OR COPIED OR USED AS THE BASIS FOR THE MANUFACTURE OR SALE OF APPARATUS WITHOUT WRITTEN PERMISSION.

ACAD REFERENCE NO. 307 ENG MASTER

DRAWN: J.LEE DATE: AUG. 11/09

CHECKED: DATE:

SCALE: NTS SHEET 1 OF 3

DRAWING NUMBER 307 Assembly ISSUE 1

### Single Row Contacts - Read One Side of Daughter Board

THIS IS A C.A.D. GENERATED DRAWING  
DO NOT MAKE MANUAL REVISIONS TO MASTER.



ISSUE NUMBER

ORIGINAL



558 Contact Code



559 Contact Code

### Single Row Contacts - Read Both Sides of Daughter Board



553 Contact Code



554 Contact Code



557 Contact Code

### Dual Row Contacts - Read Both Sides of Daughter Board



555 Contact Code



556 Contact Code

0.240 [6.10] Up to 27/54 Pin  
0.162 [4.11] 28/56 and Over



558 Contact Code

0.240 [6.10] Up to 27/54 Pin  
0.162 [4.11] 28/56 and Over  
0.290 [7.37] Up to 27/54 Pin  
.212 [5.38] 28/56 and Over



559 Contact Code



560 Contact Code

## 307/ 357 Series Card Edge Connector Contact Bend Detail

ACAD REFERENCE NO. 307 ENG MASTER

DRAWN: J.LEE DATE: AUG. 11/09

CHECKED: DATE:

SCALE: NTS SHEET 2 OF 3

DRAWING NUMBER ISSUE

307 Assembly

1



EDAC INC  
TORONTO, ONTARIO  
CANADA

YOUR CONNECTION TO QUALITY & SERVICE

THESE DRAWINGS AND SPECIFICATIONS  
ARE THE PROPERTY OF EDAC INC. AND  
SHALL NOT BE REPRODUCED, OR COPIED  
OR USED AS THE BASIS FOR THE  
MANUFACTURE OR SALE OF APPARATUS  
WITHOUT WRITTEN PERMISSION.

THIS IS A C.A.D. GENERATED DRAWING  
DO NOT MAKE MANUAL REVISIONS TO MASTER.



ISSUE NUMBER

ORIGINAL



### 307 / 357 Card Edge Connector Mounting Options



YOUR CONNECTION TO QUALITY & SERVICE

EDAC INC  
TORONTO, ONTARIO  
CANADA

THESE DRAWINGS AND SPECIFICATIONS ARE THE PROPERTY OF EDAC INC. AND SHALL NOT BE REPRODUCED, OR COPIED OR USED AS THE BASIS FOR THE MANUFACTURE OR SALE OF APPARATUS WITHOUT WRITTEN PERMISSION.

ACAD REFERENCE NO. 307 ENG MASTER

DRAWN: J.LEE DATE: AUG. 11/09

CHECKED: DATE:

SCALE: NTS SHEET 3 OF 3

DRAWING NUMBER ISSUE

307 Assembly

1