



ABSTRACT

This guide explains the hardware and software features of the DLP® Products DLP471TEEVM, DPL650TEEVM, and DLPC7540EVM evaluation modules (EVMs). The EVM architecture and connectors will be described along with a quick start guide on how to operate the DLP471TEEVM, DPL650TEEVM, and DLPC7540EVM EVMs using the DLPDLC-GUI. Specific DLP chip details and operation can be found in related component documentation.

Note

Power supply, optics, illumination source, and cables are not included. See [Other Items Needed for Operation](#).

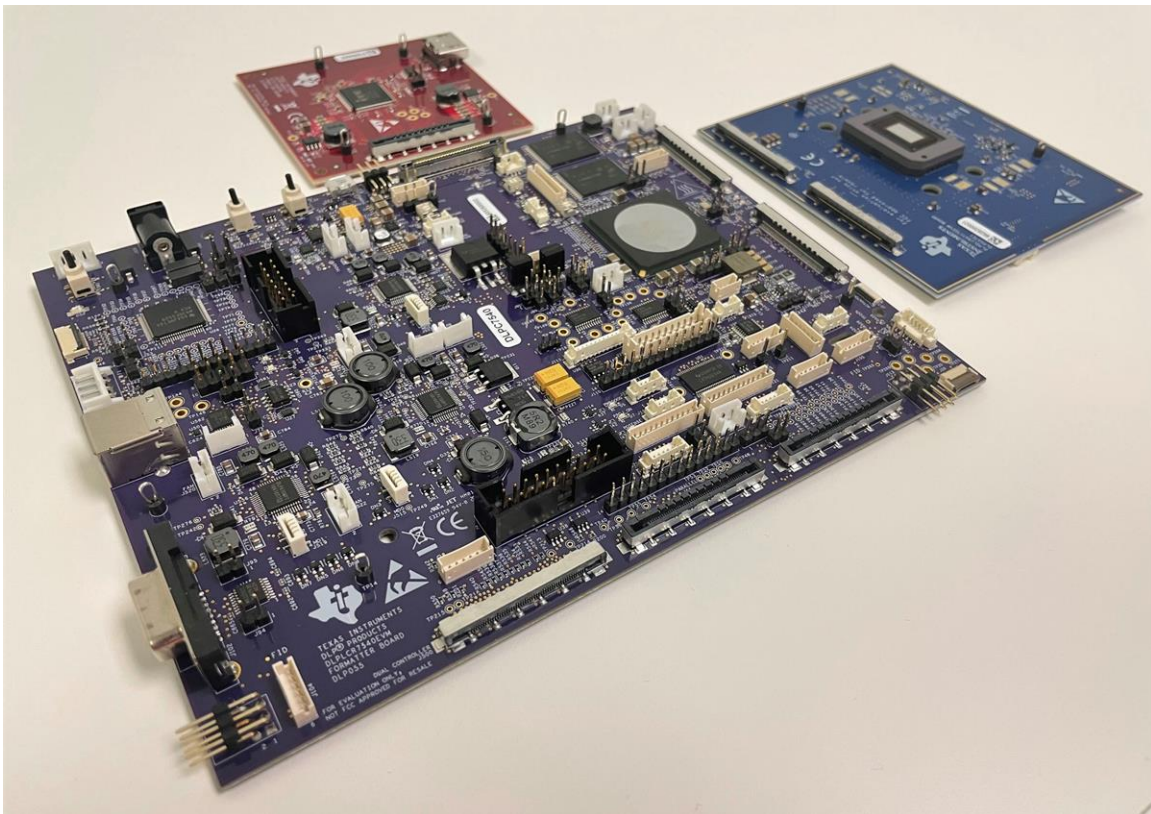

Figure 1-1. DLP Products DLPC7540EVM and DLP471TEEVM Evaluation Modules

Table of Contents

1 DLPC7540EVM, DLP471TEEV, and DLP650TEEV Overview	3
1.1 Welcome.....	3
1.2 What is in the DLP471TEEV, DLP650TEEV, and DLPC7540EVM Evaluation Modules?.....	3
1.3 EVM Boards.....	5
1.4 Other Items Needed for Operation.....	6
1.5 DLPC7540EVM, DLP471TEEV, and DLP650TEEV EVM Flex Cable.....	6
2 Quick Start	7
2.1 Downloading the Software.....	7
2.2 Connecting the DLP471TEEV, or DLP650TEEV, to the DLPC7540EVM.....	7
2.3 Powering-up the DLPC7540EVM and Preparing to Program the DLPC7540EVM.....	8
2.4 Programming the DLPC7540EVM and Displaying a SPLASH Image.....	9
2.5 Troubleshooting.....	12
3 Connections	13
3.1 DLPC7540EVM Connections.....	13
3.2 DLP471TEEV and DLP650TEEV Connections.....	15
4 Power Supply Requirements	16
4.1 External Power Supply Requirements.....	16
5 Safety	17
5.1 Caution Labels.....	17
5.2 If You Need Assistance.....	17
6 Related Documentation	17

List of Figures

Figure 1-1. DLP Products DLPC7540EVM and DLP471TEEV Evaluation Modules.....	1
Figure 1-1. DLPC7540EVM Formatter Board.....	3
Figure 1-2. DLPC7540EVM Front-end Board.....	4
Figure 1-3. DLP471TEEV.....	4
Figure 1-4. EVM System Block Diagram.....	5
Figure 2-1. Formatter Board and DMD EVM Connected.....	8
Figure 2-2. ON/OFF Switches.....	9
Figure 2-3. Command Interface Settings.....	10
Figure 2-4. Loading the Flash Image.....	11
Figure 2-5. Splash Image Displayed on DMD.....	11
Figure 3-1. DLPC7540EVM Formatter Board Connectors.....	13
Figure 3-2. DLPC7540EVM Front-end Board Connectors.....	14
Figure 3-3. DLP471TEEV and DLP650TEEV Test Points and Connectors.....	15

List of Tables

Table 2-1. Flash Image Compatibility Summary.....	7
Table 2-2. Flex Cables Connection Assignment.....	7
Table 2-3. Reference Designators.....	8
Table 2-4. Troubleshooting the Problem and the Possible Solutions.....	12

Trademarks

DLP® is a registered trademark of Texas Instruments.

All trademarks are the property of their respective owners.

1 DLPC7540EVM, DLP471TEEVM, and DLP650TEEVM Overview

1.1 Welcome

The DLP Products DLPC7540EVM, DLP471TEEVM and DLP650TEEVM evaluation modules (EVMs) offer a reference design to enable faster development cycles for users of the DLPC7540 chips and allow evaluation of TI's DLP471TE and DLP650TE UHD chipsets. These consist of one controller EVM (DLPC7540EVM) and two DMD EVMs (DLP471TEEVM and DLP650TEEVM).

These evaluation kits bring together a set of components providing a great starting point to evaluate a UHD DLP system for:

- Laser TV
- Enterprise Projectors
- Digital Signage
- Gaming Machines
- Smart Projectors
- Stage Lighting Systems

1.2 What is in the DLP471TEEVM, DLP650TEEVM, and DLPC7540EVM Evaluation Modules?

The DLP471TEEVM, DLP650TEEVM and DLPC7540EVM are designed to be used in pairs. The DMD EVMs cannot be operated without the Controller EVM, DLPC7540EVM.

The DLP471TEEVM, which includes the DLP471TE display chip, and the DLP650TEEVM, which includes the DLP650TE display chip, include the two flex cables required to connect to the DLPC7540EVM. DLPC7540EVM includes all circuitry required to drive the DLP471TE and DLP650TE display chips.

The DLPC7540EVM which consists of a formatter board ([Figure 1-1](#)) and an HDMI input processing front-end board ([Figure 1-2](#)), includes a DLPC7540 controller, three DLPA100s which serve as the power management and motor drivers, and other system circuitry such as the Vx1 interface front-end and system fan control.

The DLPC7540EVM can be programmed with either the DLP471TE or DLP650TE firmware which is available on the DLPC7540 product page. This firmware allows the DLPC7540EVM to drive either display chip. [Figure 1-1](#), [Figure 1-2](#), and [Figure 1-3](#) show the top side of all boards making up the EVMs.

Note

[Figure 1-1](#), [Figure 1-2](#), and [Figure 1-3](#) do not show the necessary flex cables needed to pair to DLPC7540EVM.

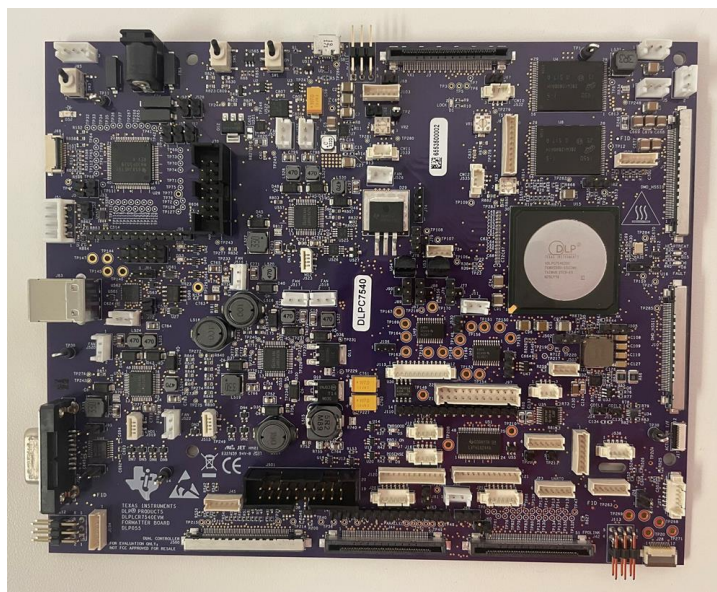

Figure 1-1. DLPC7540EVM Formatter Board

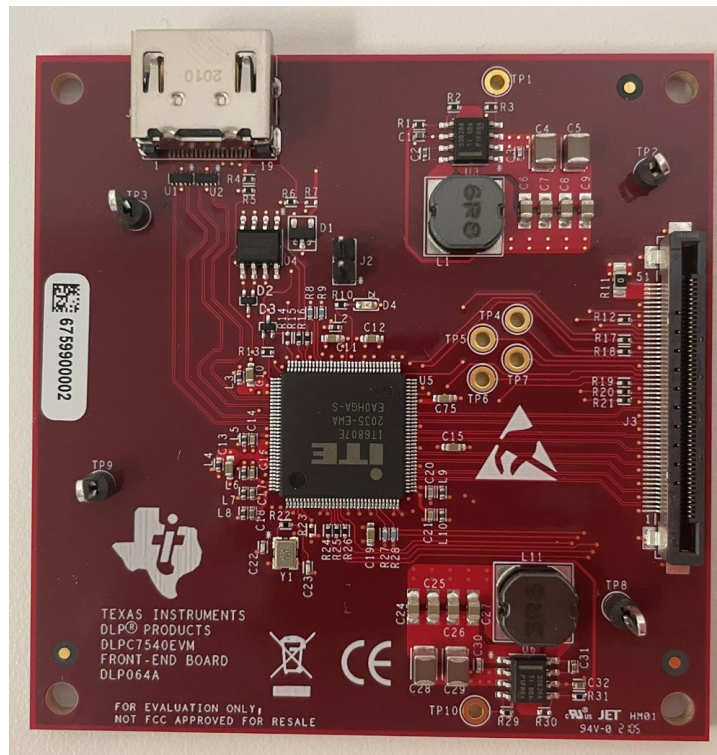

Figure 1-2. DLPC7540EVM Front-end Board

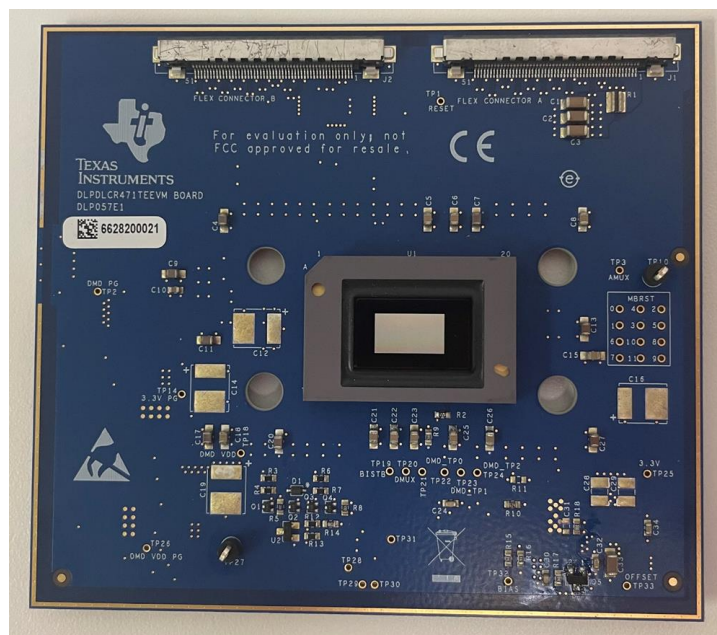

Figure 1-3. DLP471TEEV

1.3 EVM Boards

The DLP471TEEVM, DLP650TEEVM, and DLPC7540EVM EVMs contain the electronics required to drive either DLP471TE or DLP650TE DMD. The DLPC7540EVM offers several interface options for USB, I2C, and trigger inputs and outputs.

The system block diagram [Figure 1-4](#) details the functionality and control when using the DLP471TEEVM and DLPC7540EVM.

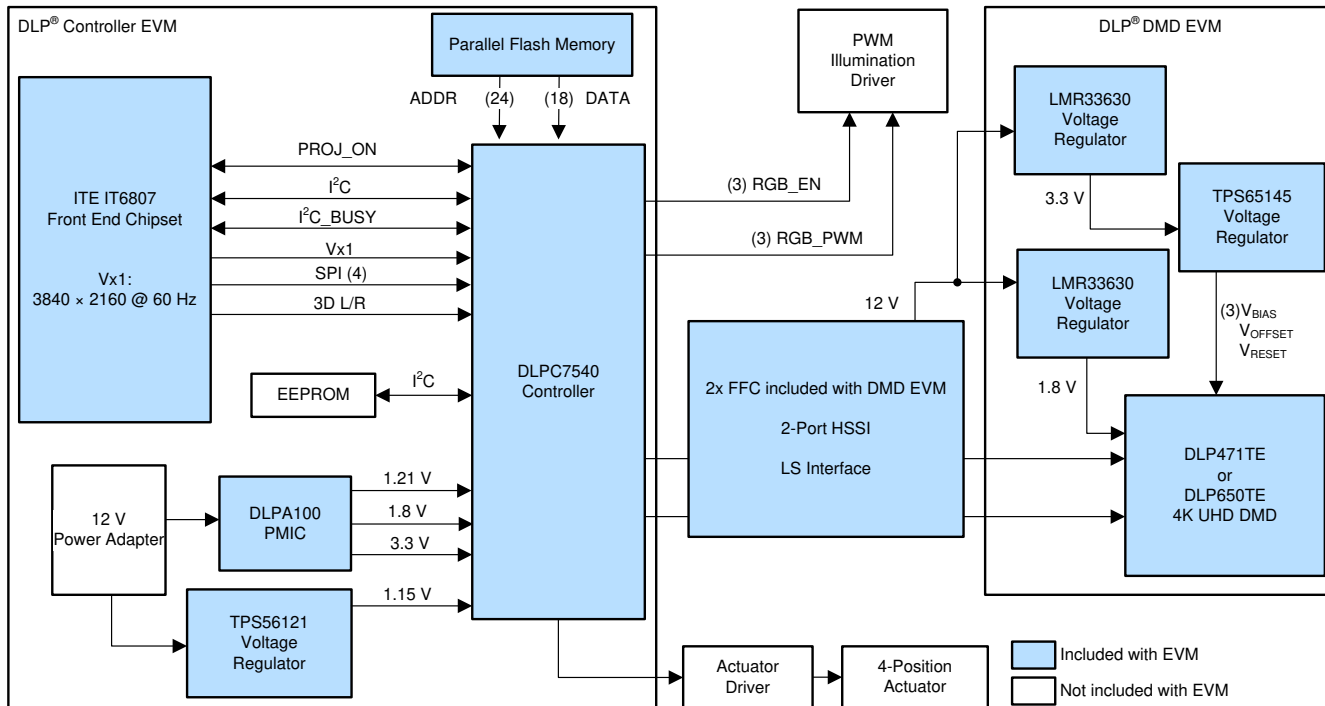

Figure 1-4. EVM System Block Diagram

The major components of the DLPC7540EVM are:

- One DLPC7540 controller
- Three DLPA100 power management and motor driver chips
- One Vx1 front-end capable of processing inputs up to 4K at 60Hz at 600MHz pixel clock

The major components of the DLP471TEEVM are:

- DLP471TE 0.47-inch 4K UHD DMD
- Two flex cables designed to connect the DLP471TEEVM to the DLPC7540EVM
- TPS65145 used to generate the DMD's offset, reset and bias voltages

The major components of the DLP650TEEVM are:

- DLP650TE 0.65-inch 4K UHD DMD
- Two flex cables designed to connect the DLP650TEEVM to the DLPC7540EVM
- TPS65145 used to generate the DMD's offset, reset and bias voltages

1.4 Other Items Needed for Operation

The DLP471TEEV, DLP650TEEV, and the DLPC7540EVM are evaluation modules (EVM) that are capable of displaying images on to the DMD. However, these EVMs do not ship with optics, illumination source, cables, power supplies, or additional hardware components. These are system parameters that are left for the user to design, the EVMs are meant to accelerate initial system design.

- Power supply - Required for EVM operation (See [Section 4.1](#))
- Micro-USB cable: A to Micro B USB cable - Required for GUI interface
- Optics
- Illumination module and source
- XPR actuator

The firmware provided on ti.com is for the sole purpose of operating the electronic components that make up the DLP471TEEV, DLP650TEEV, and the DLPC7540EVM evaluation modules. Any additions made to the EVMs such as illumination, optics, actuator, and so on will require contacting Texas Instruments for additional support in including these elements specific to customer application.

1.5 DLPC7540EVM, DLP471TEEV, and DLP650TEEV EVM Flex Cable

Electrical malfunctions can occur by stressing the flex cable(s) connecting the DMD circuit board to the DLPC7540EVM formatter board. Stressing the flex cable can be caused by:

- Bending sharply the flex cable(s).
- Repeatedly bending the flex cable(s).
- Excessive insertion and extraction of flex cables to/from board connectors.

Note

Minimize any handling/movement on the flex cables during operation

2 Quick Start

This chapter offers a quick start guide on how to connect the DLP471TEEV or DLP650TEEV to the DLPC7540EVM, how to power up the DLPC7540EVM, and how to program the DLPC7540EVM to display a SPLASH image on the DMD.

2.1 Downloading the Software

Before programming the DLPC7540EVM, ensure the DLPDLC-GUI and DMD firmware are both downloaded on the PC. The DLPDLC-GUI will allow for operation of the EVM. The DMD firmware is required so the DLPC7540EVM knows which DMD is being controlled. The DLP471TEEV comes with a DLP471TE DMD which is for 4K display applications. The EVM when installed with DLP471TE DMD can operate using DLP471TE (4K) or DLP471NE (1080p) based firmware. Similarly, the DLP650TEEV comes with a DLP650TE DMD for 4K display applications and can operate with DLP650TE (4K) or DLP471NE (1080p) based firmware. Any of the two types of DMD EVMs can also be retrofitted with their corresponding 1080p DMDs (DLP471NE/ DLP651NE) but will not have XPR operation enabled. See [Table 2-1](#) for summary of firmware compatibility.

Table 2-1. Flash Image Compatibility Summary

Flash image ¹	DLP471TEEV		DLP650TEEV	
	DLP471TE DMD	DLP471NE DMD	DLP650TE DMD	DLP651NE DMD
Flash_DLPC7540_DLP471TE_LED.img	✓	✓ ²		
Flash_DLPC7540_DLP471TE_LPCW.img	✓	✓ ²		
Flash_DLPC7540_DLP471NE_LED.img	✓ ²	✓		
Flash_DLPC7540_DLP471NE_LPCW.img	✓ ²	✓		
Flash_DLPC7540_DLP650TE_LED.img			✓	✓ ²
Flash_DLPC7540_DLP650TE_LPCW.img			✓	✓ ²
Flash_DLPC7540_DLP651NE_LED.img			✓ ²	✓
Flash_DLPC7540_DLP651NE_LPCW.img			✓ ²	✓

1. The DMD supporting firmware and DLPDLC-GUI can be found in the EVM tool folder and in the product pages on TI.com. These are the product pages for the [DLP471TE](#), [DLP471NE](#), [DLP650TE](#), [DLP651NE](#), and the [DLPC7540](#).
2. XPR operation which is required for 4K resolution is disabled.

2.2 Connecting the DLP471TEEV, or DLP650TEEV, to the DLPC7540EVM

Before connecting the DLP471TEEV/DLP650TEEV to the DLPC7540EVM, locate the two flex cables that are packaged with the DLP471TEEV/DLP650TEEV. Ensure the flex cables are not torn or damaged before connecting the DMD EVMs or the DLPC7540EVM.

The flex cables are exactly the same, meaning there is not a *right* or *left* cable. The cables are interchangeable.

Connect the DLP471TEEV or DLP650TEEV to the DLPC7540EVM formatter board by connecting the two flex cables matching the board connectors as listed in [Table 2-2](#).

Table 2-2. Flex Cables Connection Assignment

DLPC7540EVM (Formatter Board)	DLP471TEEV/DLP650TEEV
J7	J1
J10	J2

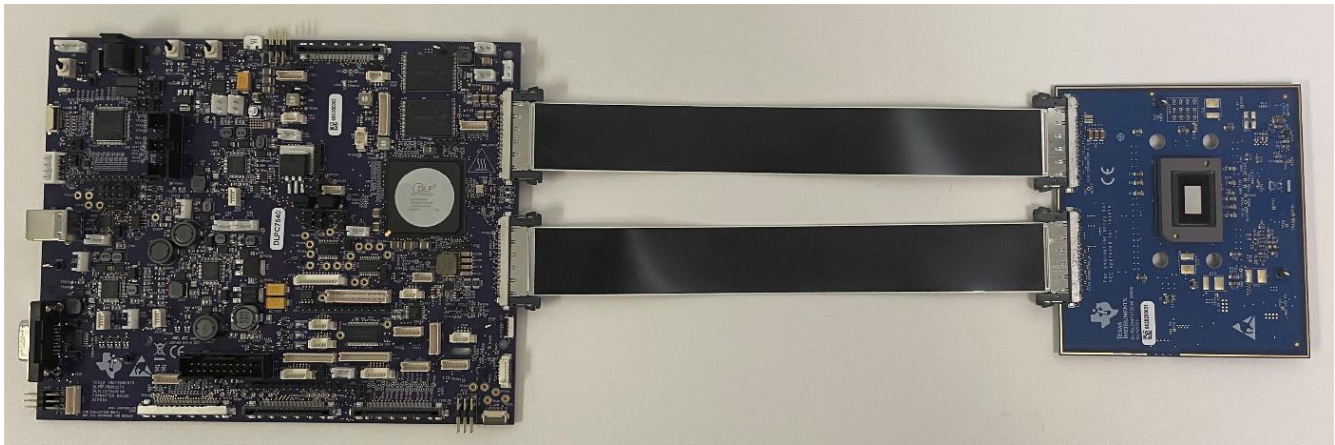

Figure 2-1. Formatter Board and DMD EVM Connected

2.3 Powering-up the DLPC7540EVM and Preparing to Program the DLPC7540EVM

There's only one jumper that is included with the DLPC7540EVM. This jumper is installed on J67 during normal operation between formatter and front-end boards. Before powering up the EVM for programming, ensure the included jumper is installed on J9 instead. The jumper locations are listed in [Section 3.1](#).

Table 2-3. Reference Designators

Jumper	Description (Bold Indicates Default Position)
J67 - Front End 5 V	Uninstalled - 5 V not supplied to J3 Installed - Formatter board provides 5 V to Front-end board over J3 connection
J9 - Hold in Boot Loader	Uninstalled - Normal Operation Installed - Hold in Boot Loader

Jumper J9 is the *Hold BL* jumper. This jumper is used to put the DLPC7540EVM into boot loader mode, which allows the DLPC7540 controller to be programmed. Connect this jumper to prepare the DLPC7540EVM to be programmed.

To power up the DLPC7540EVM, a 12-V, 5-A power supply is needed. Ensure the power supply is functional and the switch SW5 and SW1 on the formatter board are set to off before connecting the power supply to the EVM. Connecting the power supply when the switch is in the off position may prevent damage to the DLPC7540EVM from poor power connections. The image below shows SW5 and SW1 and their operating positions.

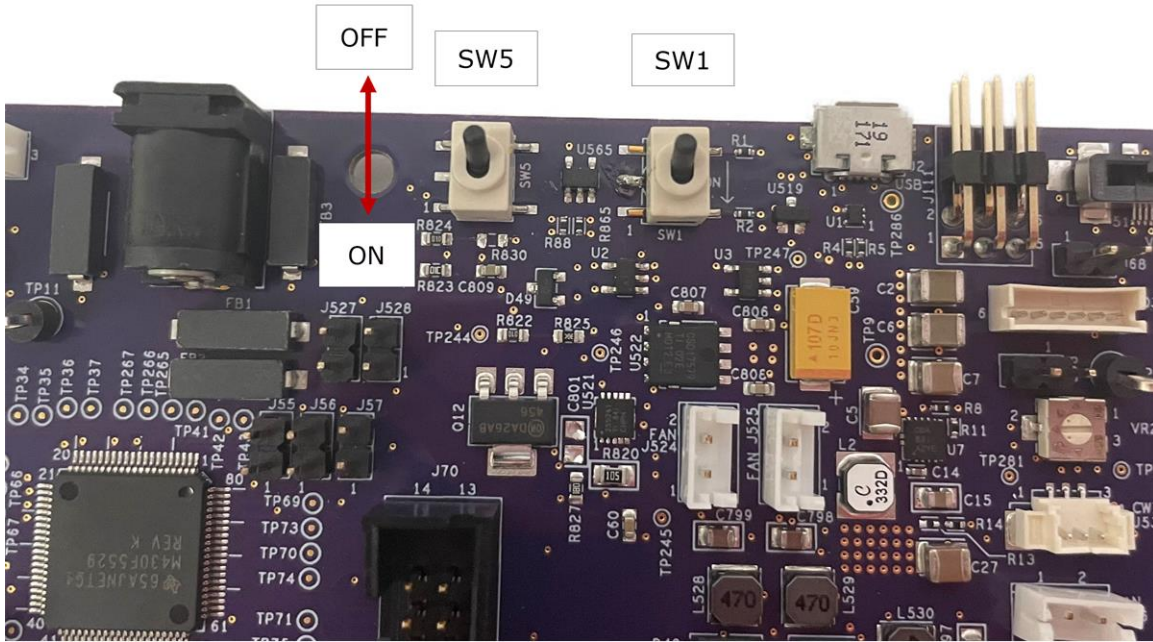

Figure 2-2. ON/OFF Switches

Once the power supply has been connected to the DLPC7540EVM, the switches SW5 and SW1 in that order can be flipped to the *on* position. You can then plug in the USB cable to J2 of the board to prepare for programming the board. Verify that D5, D6, D7 and D15 LEDs are on.

2.4 Programming the DLPC7540EVM and Displaying a SPLASH Image

Follow these steps in order to download and configure the DLPDLC-GUI for DLPC7540 operation:

1. Download the DLPDLC-GUI and the Firmware SW package that includes the Firmware binary (.img) files for DLP471TE and DLP650TE.
2. Install and open the DLPDLC-GUI
3. Setting up Communication Preferences:
 - a. DLPDLC-GUI supports USB and I2C communication. To change these settings in GUI, please go to Debug screen and select Connection tab.
 - b. For USB, please select the USB interface and click Connect [Figure 2-3](#). Note: USB is the preferred interface to download the firmware flash image to the EVM as it is much faster than I2C and won't require any additional hardware.

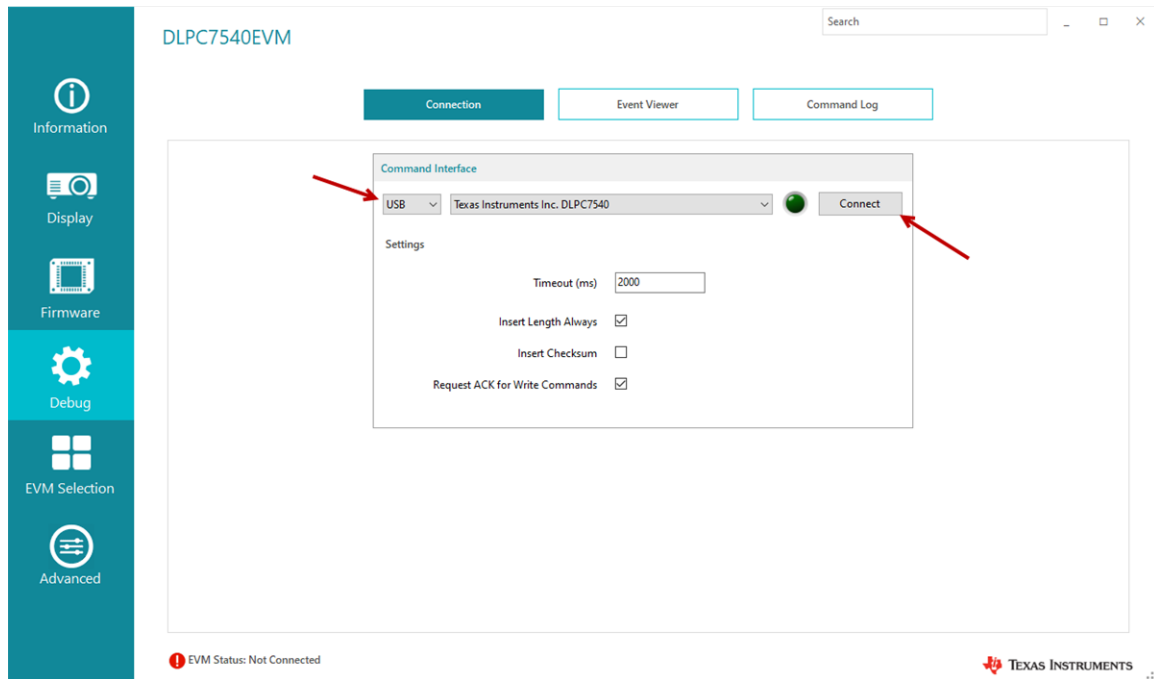

Figure 2-3. Command Interface Settings

- c. Verify that EVM Status shown at bottom left of GUI says *Connected, Bootloader Mode* indicating you are ready to load image file into EVM.
4. Flash Loader Configuration:
 - a. Go to Firmware screen, select Update Firmware tab. Click on the folder icon to browse for the applicable firmware depending on the actual DMD that is connected to DLPC7540EVM. Once firmware image file is selected, click on Start Update [Figure 2-4](#).
 - b. Wait for the programming progress to indicate that firmware update is complete.
 - c. Turn off the EVM by toggling the SW1 and SW5 switches in that order to *off* position. Remove the jumper from J9 and install it back to J67.
 - d. Turn on the EVM by toggling the SW5 and SW1 switches in that order to *on* position. After about 3 seconds you should see D5, D6, and D7 LEDs steadily on and D15 LED flashing. The DLP Texas Instruments logo should be visible on the DMD [Figure 2-5](#).

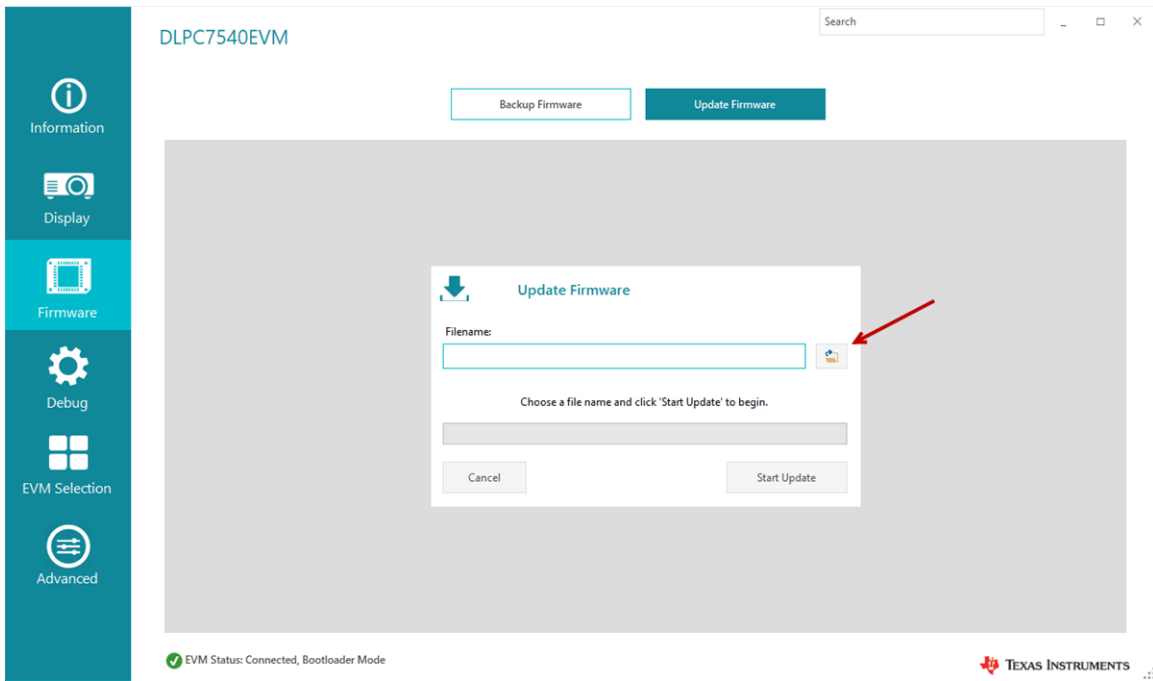

Figure 2-4. Loading the Flash Image

Note

If there is an issue with USB communication, turn off DLPC7540EVM and disconnect then reconnect USB cable and power on board.

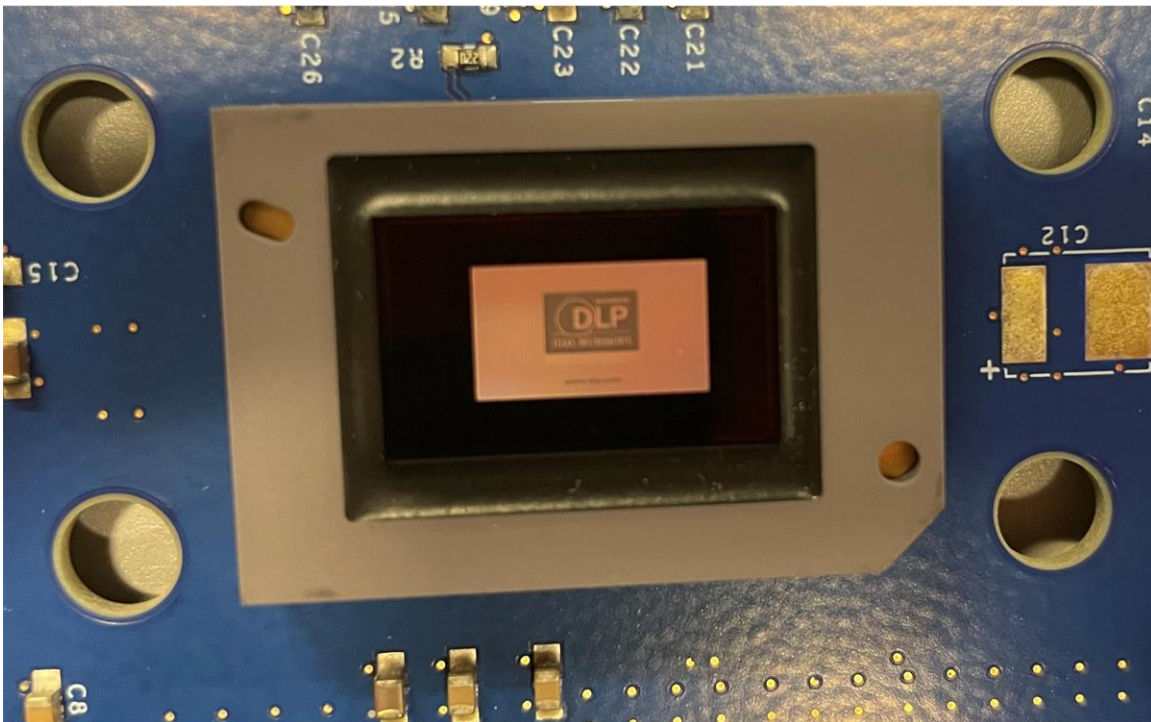

Figure 2-5. Splash Image Displayed on DMD

2.5 Troubleshooting

Table 2-4. Troubleshooting the Problem and the Possible Solutions

Problem	Possible Solutions
EVM Status: Not Connected	<ol style="list-style-type: none"><li data-bbox="699 268 992 296">1. USB cable not connected.<li data-bbox="699 302 1430 359">2. Command interface not set to USB. Go to Debug screen, Connection tab and select USB as the Command Interface, click Connect.<li data-bbox="699 365 1446 453">3. If the user has gone from using Advanced mode back to the DLPDLC-GUI, then user will need to click on EVM Status message on bottom left of DLPDLC-GUI screen to reestablish connection with GUI.

3 Connections

This chapter introduces all the connections and test points available on the DLPC7540EVM and DLP471TEEV/DLP650TEEV.

3.1 DLPC7540EVM Connections

Figure 3-1 depicts the switches and connectors with their respective locations. Note that neither cables nor the power supply are included with the module.

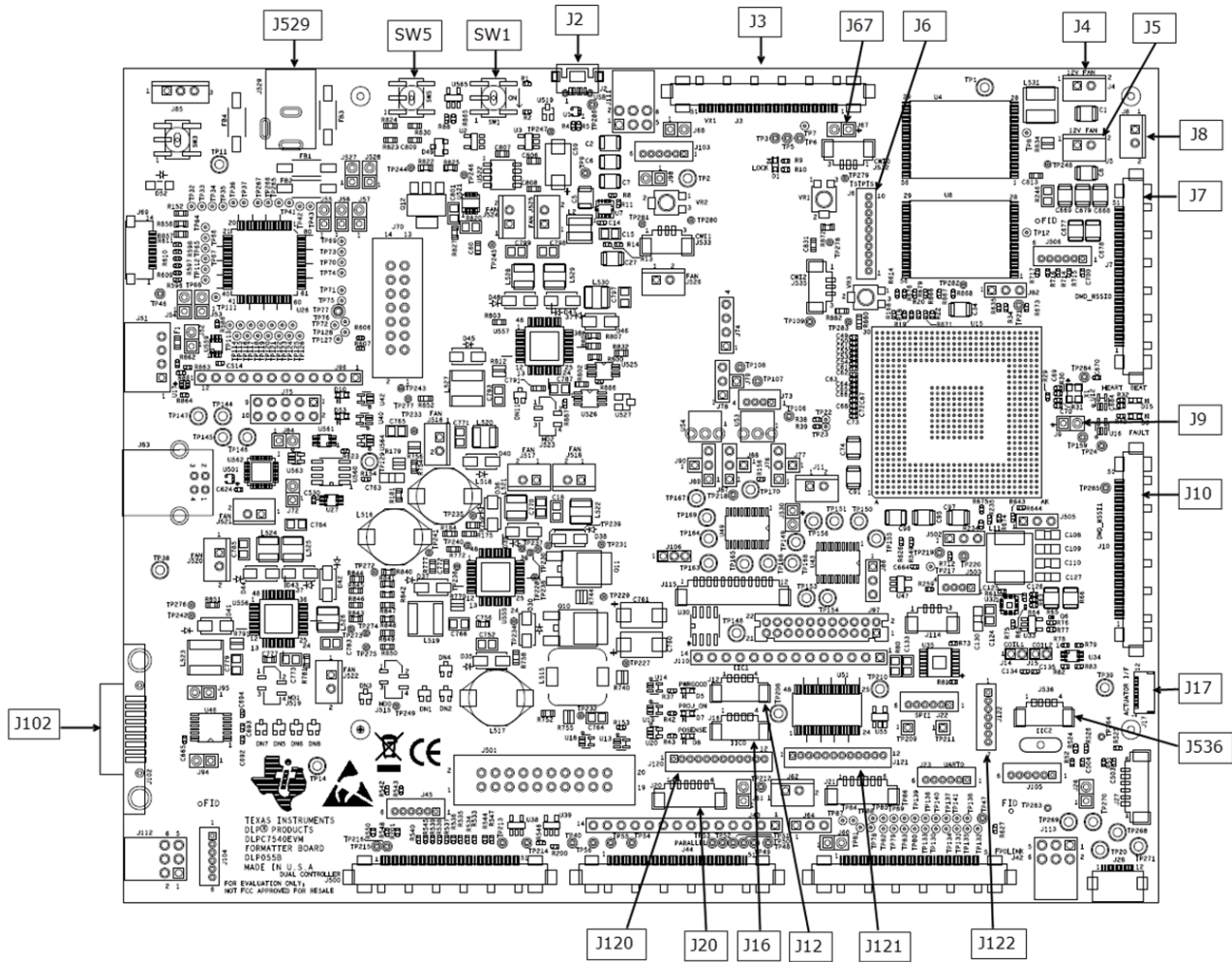

Figure 3-1. DLPC7540EVM Formatter Board Connectors

Formatter Board Connectors

1. **J2** – Micro-USB
2. **J3** – V-By-One Input
3. **J4** – 12V Fan
4. **J5** – 12V Fan
5. **J6** – Test Points Header
6. **J7** – DMD HSSI0 Flex Cable Connector
7. **J8** – 12V Fan (Heatsink)
8. **J9** – Hold Bootloader
9. **J10** – DMD HSSI1 Flex Cable Connector
10. **J12** – I2C1 Bus
11. **J16** – I2C0 Bus
12. **J17** – Actuator PWM Interface

13. **J20** – JTAG Boundary Scan
14. **J67** - 5V Enable for V-By-One Front-end Board
15. **J102** - RS232
16. **J120** - Actuator DAC Driver A/B
17. **J121** - Actuator DAC Driver C/D
18. **J122** - Actuator DAC Driver Enable
19. **J529** - 12V Input
20. **J536** - I2C2 Bus
21. **SW1** – Projector On Switch
22. **SW5** - Main Power Switch

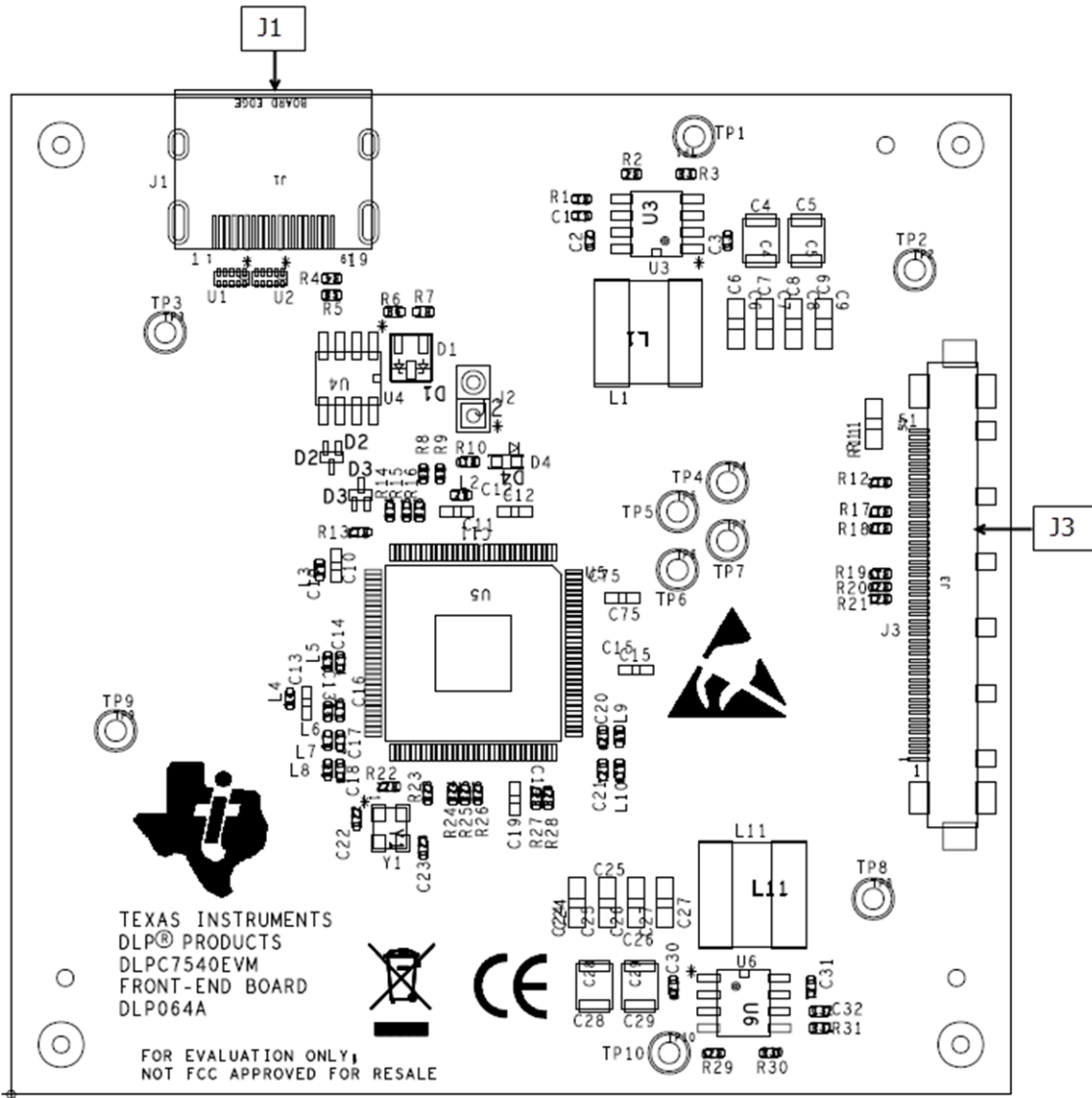

Figure 3-2. DLPC7540EVM Front-end Board Connectors

Front-end Board Connectors

1. **J1** - HDMI Input
2. **J3** - V-By-One Input

3.2 DLP471TEEVM and DLP650TEEVM Connections

Figure 3-3 depicts the switches and connectors with their respective locations.

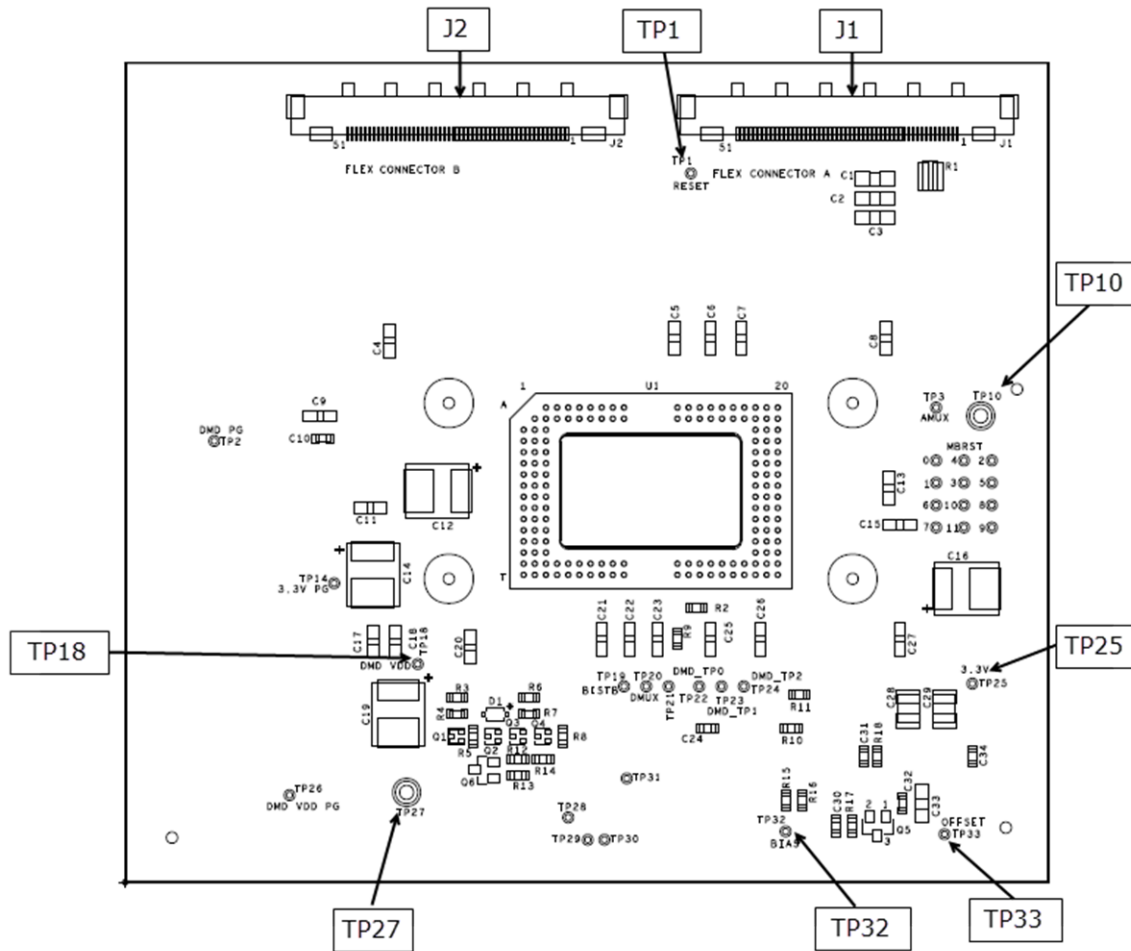

Figure 3-3. DLP471TEEVM and DLP650TEEVM Test Points and Connectors

3.2.1 Test Points

1. **TP1** - VRESET
2. **TP10** - GND
3. **TP18** - DMD_VDD (1.8V)
4. **TP25** - 3.3V
5. **TP27** - GND
6. **TP32** - VBIAS
7. **TP33** - VOFFSET

3.2.2 Connectors

1. **J1** - DMD HSSI0 Flex Cable Connector
2. **J2** - DMD HSSI1 Flex Cable Connector

4 Power Supply Requirements

4.1 External Power Supply Requirements

The DLPC7540EVM does not include a power supply. The external power supply requirements are:

- Nominal voltage: 12-V DC -5%/+10%
- Maximum Output Current: 7 A
- DC connector size:
 - Inner diameter: 2.5 mm
 - Outer diameter: 5.5 mm
 - Shaft: 9.5-mm female, center positive
- Efficiency level: V
- A recommended power supply is [Digi-Key part number 993-1009-ND](#), or equivalent

Note

External Power Supply Regulatory Compliance Certifications: Recommend selection and use of an external power supply, which meets TI's required minimum electrical ratings in addition to complying with applicable regional product regulatory and safety certification requirements such as (by example) UL, CSA, VDE, CCC, PSE, and so forth.

5 Safety

5.1 Caution Labels

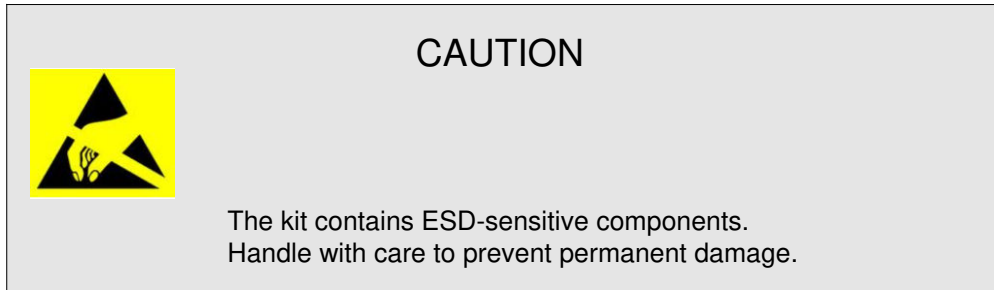

5.2 If You Need Assistance

Refer to the [DLP E2E Community support forums](#).

6 Related Documentation

1. Texas Instruments, [DLP471TE Digital Micromirror Device \(DMD\)](#) data sheet.
2. Texas Instruments, [DLP650TE Digital Micromirror Device \(DMD\)](#) data sheet.
3. Texas Instruments, [DLPC7540 DLP Display Controller](#) data sheet.
4. Texas Instruments, [DLPA100 Power Management and Motor Driver](#) data sheet.

IMPORTANT NOTICE AND DISCLAIMER

TI PROVIDES TECHNICAL AND RELIABILITY DATA (INCLUDING DATA SHEETS), DESIGN RESOURCES (INCLUDING REFERENCE DESIGNS), APPLICATION OR OTHER DESIGN ADVICE, WEB TOOLS, SAFETY INFORMATION, AND OTHER RESOURCES "AS IS" AND WITH ALL FAULTS, AND DISCLAIMS ALL WARRANTIES, EXPRESS AND IMPLIED, INCLUDING WITHOUT LIMITATION ANY IMPLIED WARRANTIES OF MERCHANTABILITY, FITNESS FOR A PARTICULAR PURPOSE OR NON-INFRINGEMENT OF THIRD PARTY INTELLECTUAL PROPERTY RIGHTS.

These resources are intended for skilled developers designing with TI products. You are solely responsible for (1) selecting the appropriate TI products for your application, (2) designing, validating and testing your application, and (3) ensuring your application meets applicable standards, and any other safety, security, regulatory or other requirements.

These resources are subject to change without notice. TI grants you permission to use these resources only for development of an application that uses the TI products described in the resource. Other reproduction and display of these resources is prohibited. No license is granted to any other TI intellectual property right or to any third party intellectual property right. TI disclaims responsibility for, and you will fully indemnify TI and its representatives against, any claims, damages, costs, losses, and liabilities arising out of your use of these resources.

TI's products are provided subject to [TI's Terms of Sale](#) or other applicable terms available either on ti.com or provided in conjunction with such TI products. TI's provision of these resources does not expand or otherwise alter TI's applicable warranties or warranty disclaimers for TI products.

TI objects to and rejects any additional or different terms you may have proposed.

Mailing Address: Texas Instruments, Post Office Box 655303, Dallas, Texas 75265
Copyright © 2022, Texas Instruments Incorporated