

Users Manual

Part Number: DMRZ-SH7C1

RazerCam™ Universal Skid-Steer User's Manual



MORE

Reliable

Profitable

Capable



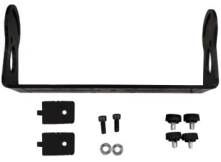









Table of Contents

I.	<u>Included RazerCam™ Kit Components</u>	<u>2</u>
II.	<u>Standard Features</u>	<u>3</u>
	A. Cameras & Brackets	
	B. Monitors & Brackets	
	C. Cables	
III.	<u>RazerCam™ Wide Angle Camera Detail</u>	<u>4</u>
IV.	<u>RazerCam™ Installation</u>	<u>4-7</u>
	A. <u>Bobcat Specific Camera Installation</u>	<u>4-7</u>
	B. <u>General Skid-Steer Camera Install</u>	<u>7</u>
V.	<u>Monitor Installation & Mounting</u>	<u>8-10</u>
	A. Mounting Precautions	
	B. Mounting on Ceiling/Mesh Cage	
	C. Alternate Mounting	
VI.	<u>Monitor Wire Harness Installation</u>	<u>10</u>
VII.	<u>Power</u>	<u>11</u>
	A. Supplying Power with 12v	
	B. Fuses	
VIII.	<u>Event Trigger Wire Operations</u>	<u>11</u>
	A. Event Trigger Wire Color Guide	
	B. Event Trigger Wires Explained	
IX.	<u>Cable Routing Tips & Warnings</u>	<u>11</u>
X.	<u>Monitor Operations</u>	<u>12-13</u>
	A. Monitor Operations	
XI.	<u>Menu Settings</u>	<u>13-15</u>
XII.	<u>Specifications</u>	<u>16</u>
XIII.	<u>Warnings</u>	<u>17</u>

*Always read the manual prior to operating this equipment. Also, please follow all safety signs and precautions.
See the Dakota Micro, Inc. website for installation training videos at www.dakotamicro.com.*

This camera kit has been designed to be installed into all Skid-Steer loader and includes multiple camera and monitor mounting options. Some skid-Steer loaders may require small to moderate end user modifications for installation, primarily in the camera mounting locations.

I. INCLUDED RAZERCAM™ SKID-STEER KIT COMPONENTS

Description	Picture	Description	Picture
Dakota Micro, Inc. 7in AHD Monitor		Universal RazerCam camera bracket mount PN: DMRZ-CBKT	
Included Skid-Steer Monitor Bracket-Included Option 1 <i>Qty 1 – Skid-Steer Monitor Bracket</i> <i>Qty 2 – Thumb screws</i> <i>Qty 2 – Washer</i> <i>Qty 2 – Mounting tabs</i> <i>Qty 2 – Wing bolts</i>		Bobcat® specific Wide-Angle Camera bracket	
Included General Mount Monitor Bracket - Option 2 Panavise Hard Mount <i>Qty 1 – Double articulated hard mount for general mounting locations</i>		Bobcat® specific Wide-Angle camera heat shield (for 770 and up models)	
Monitor Wire Harness <i>PN: DMAC-MWH</i>		15ft Power/Video Extension Cable <i>PN: DMAC-EC15</i>	
Monitor Sun Shield		12v Cigarette Lighter Power Adaptor <i>PN: DMAC-12v</i> <i>(styles vary by kit)</i>	
RazerCam™ Wide-Angle Backup Camera <i>PN: DMRZ-HC</i>		Hardwire Power Adaptor w/ quick connect clips <i>PN: DMAC-HARDWIRE</i>	

Thank you for purchasing our Dakota Micro, Inc. products.

Dakota Micro is the manufacturer of durable, reliable surveillance systems with the innovative ability to be quickly moved from one application to the next.

II. STANDARD FEATURES

A. RazerCam™ Cameras

- True HD Resolution (720P)
- 1 Year Warranty
- 16:9 aspect ratio, so the image doesn't need to be "stretched" to match monitors
- Improved color and clarity over standard analog video cameras
- Increased ability to interpret shadowed areas, allowing for a larger viewing area
- Built-in, high-quality CCD camera with high-performance lighting
- Built-in IR Lighting
- Waterproof
- Standard camera lens features a 170° Wide-Angle horizontal field of view

B. Monitors

- Feature the latest in Analog HD technology
- LED-backlit
- View both NTSC and PAL cameras
- Advanced LCD technology allows you to see your image from any angle clearly
- Mirror the view of any of your cameras for use as a backup camera
- 2 Year Warranty
- 16:9 aspect ratio
- 4 Camera Inputs
- Available in 7in size
- Event triggers for each camera allow for triggered events to bring your camera to full view (IE: putting the vehicle in reverse)
- Color, brightness, contrast and volume controls that allow compensation for use in different environments
- Sun shield and metal U-bracket monitor stand included

C. Cables

- Made in the USA
- Silicone jacketing resists heat, cold, compression & crimping
- Gold plated, corrosion resistant pins
- Watertight connections
- ¼ twist-lock keeps cables securely locked together
- Our durable power/video extension cables come in 10ft, 15ft, 20ft, 30ft, 40ft, 50ft, 60ft & 80ft lengths and feature sturdy, watertight connectors
- 1 Year Warranty

III. **RAZERCAM™ WIDE-ANGLE CAMERA DETAIL**

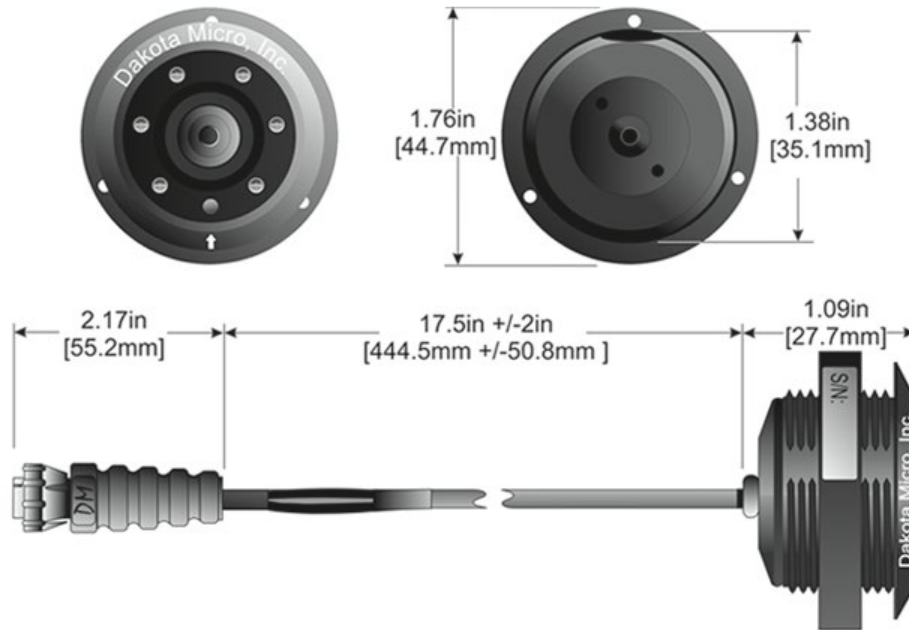

IV. **RAZERCAM™ INSTALLATION**

A. **RazerCam installation for Bobcat® Specific Skid-Steer**

- Camera kit installation will vary based upon the model and brand of Skid-Steer you are utilizing. (**For example, there may be model variations and manufacturing differences in Bobcat® builds, below are general instructions that should work for most Bobcat® equipment*).
 - ✓ 650 and lower models
 - ✓ 770 and higher models
- The RazerCam™ camera system is an independent aftermarket system and installation of this camera may void manufacturer warranty. Check with your manufacturer for details.
- The primary reason for the varying installation is the location of the muffler in the rear compartment, requiring the use of a heat shield during the camera installation process.

RAZERCAM INSTALLATION FOR BOBCAT 650 AND LOWER MODEL SKID-STEER

Bobcat 650 and lower models have the style back door illustrated to the right. The rear of this style Bobcat is simpler and is identifiable by the lack of fans and no extra exhaust across the top.



The existing beeper mounts look like the image to the right. Remove the beeper mount from the rear door and then remove the bracket from the beeper. Be sure to keep the bolts in a safe place, as they will all be reused.

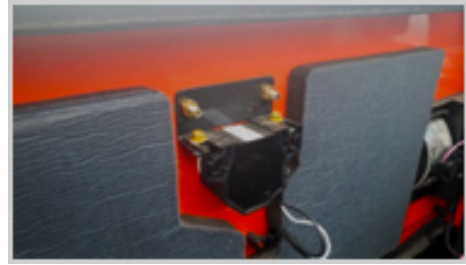

Remove the securing nut from the rear of the wide-angle camera.

Place the camera into the camera mounting bracket as shown, and screw securing nut back onto camera, sandwiching the camera bracket between the camera and securing nut.

Note that the two screw holes at the top of the bracket are "up," so be sure that the words "Dakota Micro" that is printed at the top of the camera are centered at the top of the bracket.



Place bracket, with camera attached, onto the rear door, making sure that the camera is pointed out. **DO NOT SCREW ON YOUR NUTS YET; YOU STILL NEED TO PUT YOUR BEEPER BACK ON.**



Reattach the beeper to the original bracket **but rotate the bracket, as shown in the image using the original bolts.**



Reattach the beeper to the door using the original nuts.

Check the camera and beeper to verify that they are not touching in any way. There should be a small space between the camera and the beeper if they are touching in any way to check your assembly process.



When installation is complete, camera should appear like image on right. Camera should be pointed 30 degrees downward and centered in the hole.



RAZERCAM INSTALLATION FOR BOBCAT® 770 AND HIGHER MODEL SKID-STEER

Bobcat® 770 and up models have the style back door illustrated to the right. The rear of this style Bobcat is more complex and is identifiable by the additional fans and extra exhaust across the top.



The beeper on these models uses a different mounting bracket that includes a heat shield.

Remove the beeper mount from the rear door and then remove the bracket from the beeper. Be sure to keep the bolts in a safe place, as they will all be reused.

For this installation, we will **NOT** be reusing the bracket.



Remove the securing nut from the rear of the wide-angle camera

Place the camera into the camera mounting bracket as shown, and screw securing nut back onto the camera, sandwiching the camera bracket between the camera and securing nut.

Note that the two screw holes at the top of the bracket are "up," so be sure that the words "Dakota Micro" that is printed at the top of the camera are centered at the top of the bracket.



Place bracket, with the camera attached, onto rear door, making sure that the camera is pointed out. DO NOT SCREW ON YOUR NUTS YET; YOU STILL NEED TO PUT YOUR BUZZER BACK.



Mount the beeper, using the original screws, to the Dakota Micro provided heat shield. When complete, your beeper should look like the image on the right.



Attach the heat shield and beeper assembly to the door (on top of the camera/bracket), using the original nuts.

Check the camera and beeper to verify that they are not touching in any way. There should be a small space between the camera and the beeper if they are touching in any way to check your assembly process.



When the installation is complete, the camera should appear like image on right. Camera should be pointed 30 degrees downward and centered in the hole.

Verify that the rear door is able to close without any contact between the new brackets and any part of the interior of the engine compartment.



B. General Skid-Steer Camera Installation

*Camera kit installation will vary based upon the model and brand of Skid-Steer you are utilizing.

Locate Universal RazerCam™ camera bracket.



Remove the securing nut from the rear of the RazerCam™ camera.

Place the camera into the camera mounting bracket as shown, and screw securing nut back onto camera, sandwiching the camera bracket between the camera and securing nut.

Note that the two screw holes at the top of the bracket are “up,” so be sure that the words “Dakota Micro” that is printed at the top of the camera are centered at the top of the bracket.

Mount RazerCam™ in its desired location. Image to right shows camera mounted using a Dakota Micro magnet. There are also a variety of screw holes in the bracket to allow for multiple mounting options.



V. MONITOR INSTALLATION & MOUNTING

A. Mounting Precautions

Remove your monitor carefully from packaging and inspect all mounting hardware. Mounting location is the most important part of the monitor installation as it ensures you the maximum visual benefit from your RazerCam™ system. With that said, when installing your monitor, ensure to follow these three (3) precautions:

1. The monitor is out of direct sunlight. This will prolong the life of the unit as well as ensure optimum visibility.
2. The monitor does not obstruct view.
3. The monitor does not interfere with the normal operation of equipment.

B. MONITOR INSTALLATION & MOUNTING FOR SKID-STEER WITH STEEL GRID CAGE

Locate Steel Grid Cage monitor mounting bracket and ensure that all mounting components are available. Your monitor mounting bracket installation will require:

1. Qty 1 – Monitor Bracket
2. Qty 2 – Mounting tabs
3. Qty 2 each – Thumb Screws & Washers
4. Qty 4 – Wing bolts

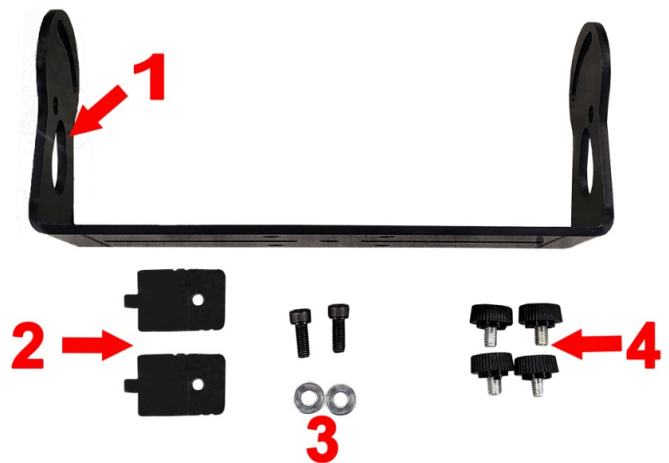

Attach Mounting tabs to Monitor bracket using Thumb screws & Washers (Save the wing bolts to attach the Monitor to the monitor bracket).



IMPORTANT NOTE: The included Mounting Tabs have a “point” (indicated with the arrow on the image to the right) on one side.

Some installations will require the “point” of this tab to be attached to the Monitor bracket so that they are pointing “in,” others will require them to point “out.” This will depend on which style of Skid-steer you have and which dimension metal grid you have on the ceiling of your Skid-steer.

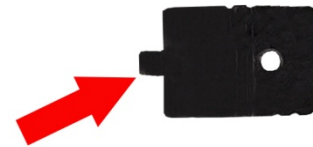

Mounting tabs with Points “In”

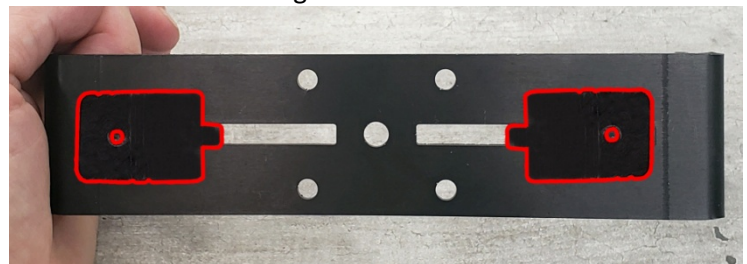

Mounting tabs with Points “out”

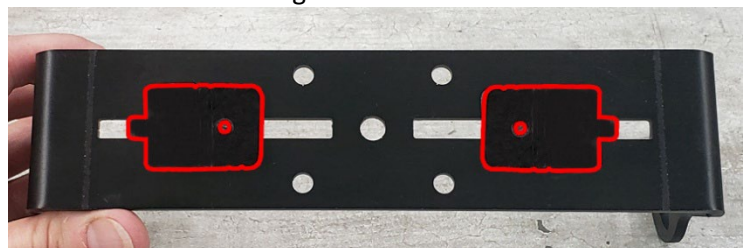

Before installation of Monitor bracket, note that it has a “front” and a “back.” The monitor should be mounted so that the fixed hole on the side of the bracket it toward the operator



Mounting tab “points” will slip under the metal grid on the roof of your skid-steer. Tighten the bolts to secure the bracket to the metal grid.



Attach your Dakota Micro monitor to installed bracket utilizing included wing bolts.

Attach monitor sun shield if desired.



C. MONITOR INSTALLATION & MOUNTING FOR ALTERNATE LOCATION

In situations where your skid-steer doesn't have the appropriate steel cage, or if alternate mounting is desired, Dakota Micro provides a more generalized mounting bracket that includes dual articulation points for easy mounting in multiple locations.



VI. MONITOR WIRE HARNESS INSTALLATION

A. Monitor Wire Harness Details

1. Input to Monitor
2. AV1-4 Event Trigger Wires (Pg. 6)
3. Power Input
4. RCA-Video Output (*not functional on this model*)
5. AV1 - Audio/Video Input
6. AV2 - Audio/Video Input
7. AV3 - Audio/Video Input
8. AV4 - Video Input

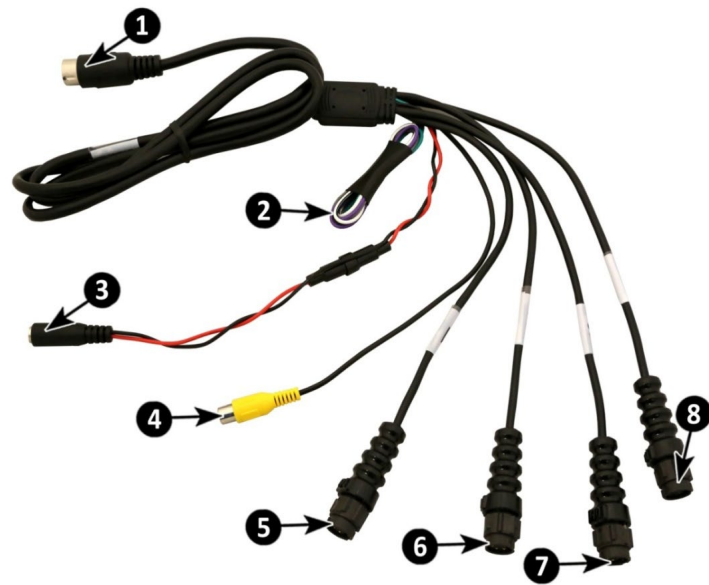

VII. POWER

A. Supplying Power with 12v Power Adaptor

1. Attach the power input connector (3 above) to your included 12v cigarette lighter power adaptor. If direct wire is desired, a hardwire power adaptor is also included in your kit.
2. Plug cigarette lighter adaptor into 12v power source.

B. Fuses

1. There is a small in-line glass fuse located on the red and black power wire (3 above). When replacing this fuse, use a MAX 2amp glass fuse.
2. There is a small glass fuse located on the inside tip of the 12v portion of the power adaptor (PN: DMAC-12v). When replacing this fuse, use a MAX 2amp glass fuse

VIII. EVENT TRIGGER WIRE OPERATIONS

A. Event Trigger Wire Color Guide

1. Camera 1 – Green
2. Camera 2 – Purple
3. Camera 3 – Gray
4. Camera 4 – White

B. Event Trigger Wires Explained

Event trigger wires can be attached to any 12v positive event. This will cause the monitor to change to that camera, regardless of the state of the monitor (i.e., ON/OFF or channel selection). The most recent event will be the primary display. So, if two (2) video channels (AV1 & AV2) are attached to an event output, the event that happens last will change the monitor to its respective camera view.

The wires can be attached to any positive output 10.5v to 16.9v switch or supply to cause the monitor to automatically switch the unit to its respective channel camera. **Example:** if you were to attach the AV1 wire to a positive output from an unloading auger on a combine, the monitor would switch from channel 2, 3, or 4 to channel 1 when the auger is extended. The event circuit should be neutral in its normal state and change to HIGH (+12v) when the event is considered to be active.

IX. CABLE ROUTING TIPS & WARNINGS

Your Bobcat kit includes one (1) 15ft power video extension cable. If you would like to purchase different or additional cable lengths, please contact your local Dakota Micro, Inc. dealer. There are any numbers of ways you can route your power/video extension cable from your monitor back to your camera; we will leave that up to the individual users. Cable routing is important; where you choose to run the cables should not interfere with the normal operation of the machine or any safety equipment.

- ALWAYS be aware of any “pinch points” or other potential hazards to the cable(s).
- Secure all cables to vehicle/equipment using cable clips, zip ties, or other style fasteners.

X. MONITOR OPERATION

A. 7" Monitor Operations – Front



1-3 FOR USE ONLY WITH DM AHD Quad Processors

1	Full Screen	When connected to DM AHD Quad, will show cameras 1/2/3/4 each time pressed.
2	Duplex Screen	When connected to DM Quad will show Camera 1 /4 and camera 2 /3 each time pressed.
3	Quad Screen	When connected to DM Quad will display all 4 cameras connected.
4	- Key	To decrease parameter
5	+ Key	To increase parameter
6	MENU	Allows users to access menu. Once in menu, toggles through menu options of Picture, Volume, Function, System & Clock
7	AV Key	Each button press switches between AV1, AV2, AV3, & AV4. Also selects menu options within sub menus
8	Power	Powers Monitor ON and OFF (2 second delay)

PICTURE

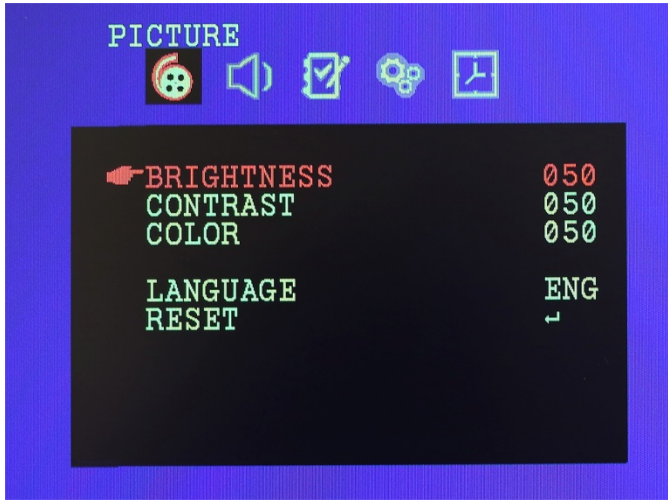

BRIGHT: Adjusts the brightness of the image.
CONTRAST: Adjusts the contrast of the image.
COLOR: Adjusts the color of the image.

LANG: Select your language (English default)
RESET: Returns settings to default.

VOLUME

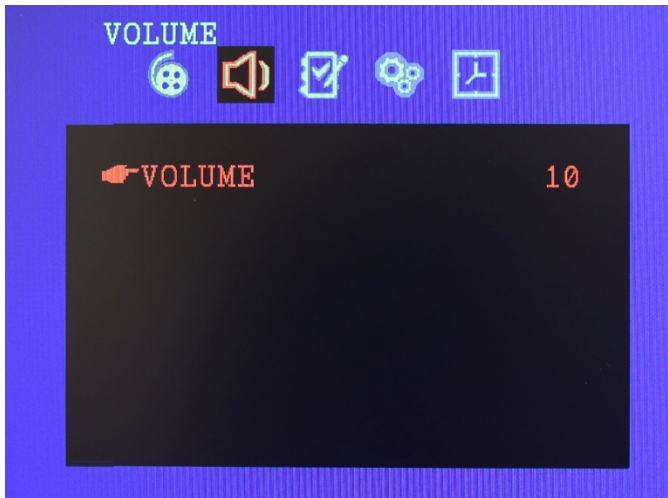

VOLUME: Adjusts the volume level.

FUNCTION

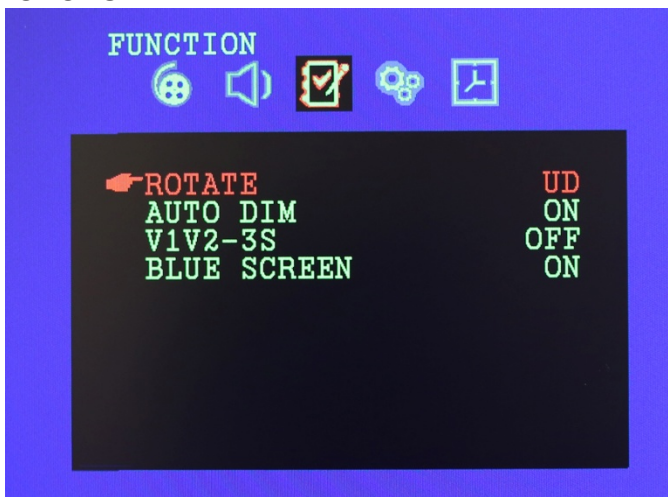

ROTATE: Allows for the adjustment of image Up/Down

AUTO DIM: Allows user to turn auto dim function ON/OFF. When on, auto dim will automatically dim monitor based on lighting conditions.

V1V2-3s: When set to ON cycles through cameras in 5 second intervals.

BLUE SCREEN: Allows users to adjust the color that is displayed when no camera is present. When ON blue will be displayed, when OFF, screen will be black.

SYSTEM

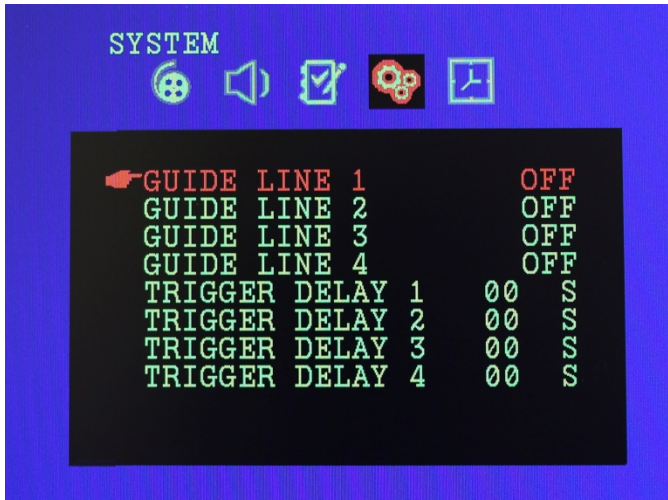

GUIDE LINE 1-4: Allows users to turn ON/OFF guides. Guide lines appear only during triggered event.
TRIGGER DELAY: Allows users to set duration of triggered camera on individual cameras.

CLOCK

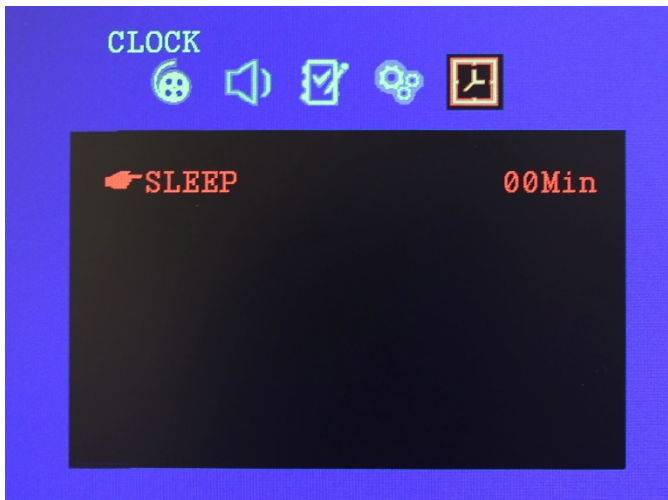

SLEEP: Allows users to set a time frame for the monitor to automatically shut down/go to sleep.

XI. SPECIFICATIONS

A. Camera	
Video System	NTSC
Video Type	AHD = 720P
Image Pickup Device	Panasonic CMOS ¼ inch wide view
Horizontal Resolution	720P
Image Ratio	16:9
Auto Gain Control	Automatic based on lighting
Scanning System	Progressive
Camera Board Lens	170° FOV
Operating Temp	-45°F~150°F (-42°C~66°C)
Construction	Aluminum Case
Warranty	1 Year
Waterproofing Criteria	IP68
Dimensions	1.76in (W) x 1.09in (D)
Connector Type	5 pin Conxall/Switchcraft (AgCam/EnduraCam/RazerCam connector)
IR Lighting	Visible White Light
B. Monitor	
Screen Size	16:9 Digital Panel
Overall Size	7in - 4.84(H)x7.04(W)x1.14(D)in 123(H)x179(W)x29(D)mm
Weight	396g avg. (7in)
Power Input	DC 10–32v
Color System	NTSC/PAL auto switch
Operating Temp.	-30°F~130°F (-34°C~+54°C)
Brightness	350cd/m ²
Resolution (HxV)	1024(H)x600(V)
Contrast	500:1
Viewing Angle	L/R: 70° Up: 50° Down: 70°
Operating Voltage	Min. 12v (Check monitor label for specific voltage range)
Lighting Source	LED Backlight
Environmental Rating	IP50
Video Output Port	RCaX1 Video Out - Analog (CVBS) ONLY
Video Input Port	X4 AHD video input channels
C. Extension Cables	
Connector Type	5 Pin Conxall/Switchcraft
Cable Type	Dual Core 26 AWG, Silicone Jacketed
RoHS Compliant	YES
Shielded	Yes
Strain Relief	Over molded
Watertight Connections	Yes
Operating Temp.	-45°F~150°F (-42°C~66°C)
Max Recommended Pulling Tension	10 lbs

XII. WARNINGS

- When selecting a camera system from Dakota Micro, be sure to utilize the appropriate system for your use. AgCam and EnduraCam cameras are designed for high impact, moisture, vibration and a variety of other rough conditions. OverView cameras and kit components are designed for light use, low vibration and low moisture. OverView equipment is not warranted when used in situations outside of the above mentioned parameters. We always request that customers keep in mind that our less expensive OverView product line is cheaper because it does not feature the reliability and durability of our AgCam and EnduraCam lines. The warranty available on these products reflect that durability.
- To avoid electrical shock and maintain optimal functionality, do not open the enclosures. High voltage may be present and there are no user serviceable parts inside. All warranties will be void should any enclosures be tampered with in any way.
- Do not use any harsh chemical solvents, cleaning agents or corrosive detergent to clean away dirt on the surface of the screen or lens.
- On AgCam and EnduraCam products, the photo-chromic camera lenses have been made impact-resistant and have been drop-ball tested according to Sec. 3.84,21 CRF BUT ARE NOT UNBREAKABLE. Because they have been hardened chemically, they show no stress pattern. Inspect your lenses frequently. Chipped or scratched surfaces will reduce protection. Such lenses should be replaced only by the manufacturer.
- Power to cameras is not interrupted by turning off monitor; 12v power source must be terminated when not in use to avoid battery drain. To avoid this problem be sure when hard wiring a unit, use a 5 amp max fused circuit.
- Do not use your Dakota Micro camera system for anything other than legal surveillance and observation uses. Dakota Micro, Inc. is not liable for any illegal or nefarious usage.

XIII. PRODUCT WARRANTY/REPAIR PROCESS

1. For Technical Support call 1 701 538-4403 OR email techsupport@dakotamicro.com
2. Technician will assist in troubleshooting product malfunction.
3. If product malfunction cannot be remedied and a repair is deemed necessary, Technician will issue a Repair Authorization (RA) number.

IMPORTANT NOTE:

The Technician will note on the RA form if the repair APPEARS to be a warranty or non-warranty issue based on customer description of the issues at hand. No final determination can be made until inspection and testing of the equipment is completed at the factory.

4. To ensure fast and effective repairs, customer is required to send:
 - Dakota Micro Product that Technician has requested/deemed necessary in the proper diagnosis and repair of malfunction. This may include some or all components of the kit.
 - Original/Copy of purchase receipt.
 - For serialized items ONLY; If a copy of the original purchase receipt cannot be provided, then DAKOTA MICRO will use the product manufacture date.
 - Customer information, including return address & phone number. If the phone number is not included, the customer will be sent a letter requesting the needed information.
 - RA Number provided by Dakota Micro Technical Support
 - Shipping and associated costs to ship product to DM factory to be borne by the customer unless otherwise specified.
5. Customer should mail product to:

Dakota Micro, Inc.
RA # XXXXX
8659 148th Ave. SE
Cayuga, ND 58013
6. Upon receipt and evaluation of product at Dakota Micro Factory, it will be established if the repair is warranty or non-warranty. If requested, customer will be called and notified of any applicable charges.
7. If the repairs are deemed non-warranty, and require a service/repair fee of any kind, a credit card number will be requested by Order Processing after the repair is completed.
8. If customer is unable to be contacted over the course of 3 weeks regarding required non-warranty repairs, product will be returned, unrepared, to the customer.
9. Any product returned without proper documentation may be returned at customer's expense.
10. Product returned with unconfirmed problems will be assessed a \$60 evaluation fee per unit
11. Return shipping costs will be borne by the party at fault; in other words, if Dakota Micro determines that the defective product was covered under warranty, Dakota Micro pays the shipping charges. If Dakota Micro determines that it was the customers fault, the customer will pay shipping charges. If a particular circumstance cannot be determined than the cost of shipping charges will be decided on a discretionary basis depending on the situation at hand.

XIV. CONSUMER LIMITED WARRANTY

Subject to the disclaimer, limitations and other directions stated hereafter, Dakota Micro, Inc. warrants that the Product will be free from defects in material and workmanship for periods as stated hereafter from the date of original purchase. **THIS WARRANTY IS EXPRESSLY MADE IN LIEU OF ANY AND ALL OTHER WARRANTIES, EXPRESS OR IMPLIED, INCLUDING THE IMPLIED WARRANTIES OF MERCHANTABILITY OR FITNESS. THE EXCLUSIVE REMEDY OF THE BUYER IS LIMITED TO REPAIR OR REPLACEMENT OF THE PRODUCT. EXCEPT AS STATED IN THIS WARRANTY, DAKOTA MICRO SHALL NOT BE LIABLE FOR ANY LOSS, INCONVENIENCE, OR DAMAGE, INCLUDING DIRECT, SPECIAL, INCIDENTAL, OR CONSEQUENTIAL DAMAGES, RESULTING FROM THE USE OR INABILITY TO USE THE PRODUCT, WHETHER RESULTING FROM BREACH OF WARRANTY, NEGLIGENCE, STRICT LIABILITY OF ANY OTHER LEGAL THEORY.** Any oral statements or representations made by anyone which are contrary to or at variance with the terms stated in this **LIMITED WARRANTY** are void.

Dakota Micro will, at its option, either repair the defect or replace the defective Product or part thereof with a new or remanufactured equivalent at no charge to the purchaser for parts or labor for the period of three (3) years for AgCam® /EnduraCam® and InnoPro® cameras; two (2) years for AgCam®/ EnduraCam® monitors, and Wireless components; Twelve Months (12) for all RazerCam, Overview Cameras & Monitors, cables and all other accessories.

The Dakota Micro limited warranty periods outlined above apply throughout the United States and Canada only. A one (1) year maximum limited warranty for all Products applies to all other geographic locations unless otherwise stated in writing by Dakota Micro.

This limited warranty does not apply to any issues connected with appearance that have no relation to the performance of the Product nor to any Product the exterior of which has been damaged or defaced, which has been subjected to improper voltage or other misuse, abnormal service or handling, or which has been altered or modified in design or construction.

In order to enforce the rights under this limited warranty, the purchaser should follow the steps set forth in the complete Dakota Micro "Warranty & Repair Policy" listed on page 11 - section XV, and provide proof of purchase to Dakota Micro.

Neither the sales personnel of Dakota Micro nor any dealer or any other person is authorized to make any warranties other than those described herein, or to extend the duration of any warranties beyond the time periods described herein.

The warranties described herein shall be the sole and exclusive warranties and remedies provided by Dakota Micro. Correction of defects, in the manner and for the period of time described herein, shall constitute complete fulfillment of all liabilities and responsibilities of Dakota Micro to the purchaser with respect to the Product, and shall constitute full satisfaction of all claims. In no event shall Dakota Micro be liable or in any way responsible for any damages or defects in the Product which were caused by repairs or attempted repairs performed by anyone other than Dakota Micro.

Some states do not allow the limitation or exclusion of incidental or consequential damages, so said limitation may not apply to you.

Any action at law, suit in equity, or other judicial proceeding for the enforcement of any right provided for herein or otherwise, or with respect to any claim that a purchaser may have against Dakota Micro shall be instituted only in the Courts of the State of North Dakota, either in the state district court located in Wahpeton, North Dakota or in Federal District Court location in Fargo, North Dakota. Without regard to conflicts of law principles, the laws of the state of North Dakota shall govern the interpretation and enforcement of the terms of this Limited Warranty and all aspects of the relationship between Dakota Micro and the purchaser.

This warranty gives you specific legal rights and you may also have other rights, which may vary from state to state.

XV. DISCLAIMER

Dakota Micro Inc. products, specifications, pricing and programs are subject to change without prior notice. Dakota Micro Inc. reserves the right to make design changes at any time without obligation to retroactively install them on previously sold units.

XVI. CONTACT US



8659 148 ½ Ave. SE.

Cayuga, ND 58013

Management System Registered to ISO 9001

www.dakotamicro.com