

PROPER USE GUIDELINES

Cumulative trauma disorders can result from the prolonged use of manually powered hand tools. Hand tools are intended for occasional use and low-volume applications. A wide selection of powered application equipment is available for extended-use production operations. The SDE-SA hand tool is a commercial-grade tool. Product crimped with this tool meets the wire barrel crimp height requirement for hand tools in the appropriate 114 application specification, but might not comply with other feature parameters of the specification.

Figure 1: SDE-SA Commercial Hand Tool Assembly 2390076-1 with Die Assembly 2390076-2

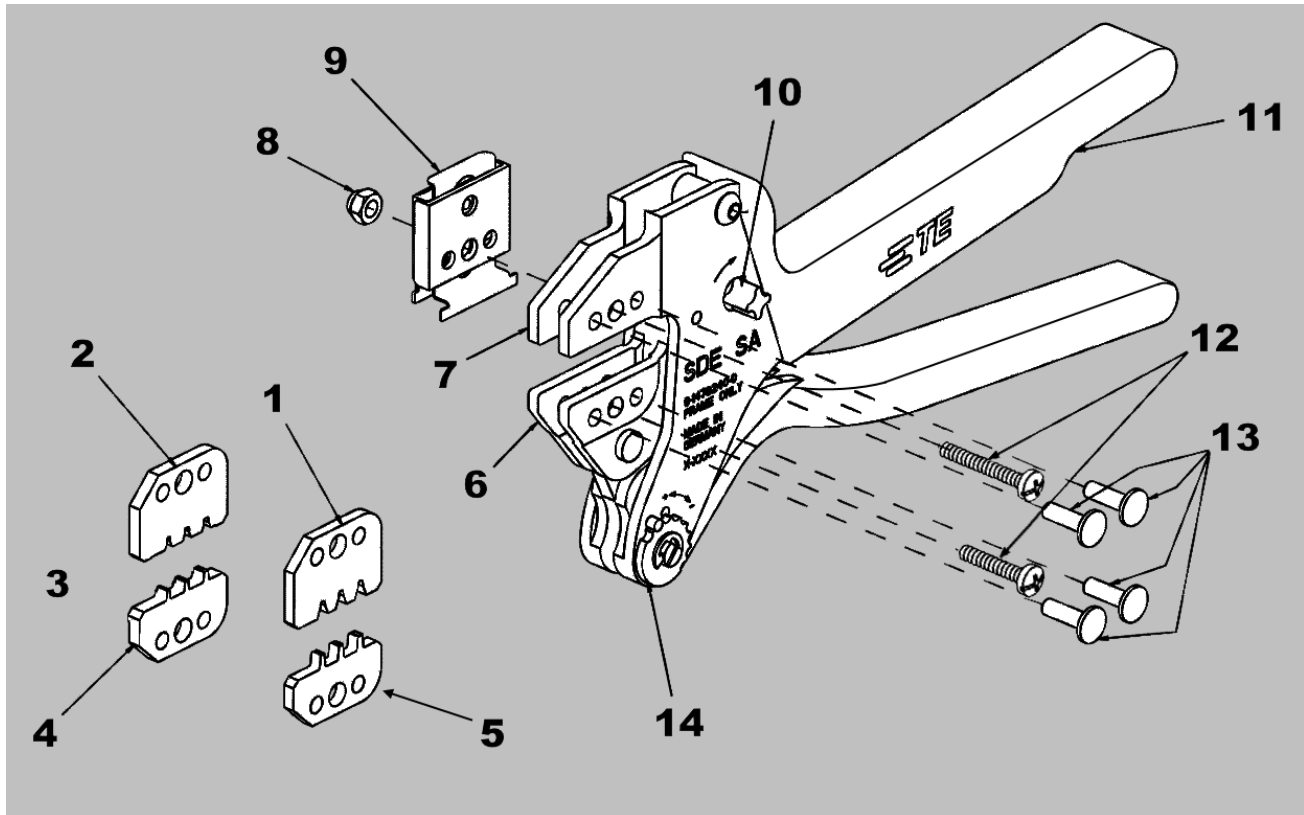

- | | | |
|---|-------------------------------------|------------------------------------|
| 1 Insulation crimper (upper die) | 6 Moving jaw | 11 Handle |
| 2 Wire crimper (upper die) | 7 Stationary jaw | 12 Die-retaining screws (2) |
| 3 Die set 2390076-2 | 8 Nut | 13 Die-retaining pins (4) |
| 4 Wire anvil (lower die) | 9 Locator | 14 Ratchet adjustment wheel |
| 5 Insulation anvil (lower die) | 10 Emergency ratchet release | |

1. INTRODUCTION

SDE-SA Commercial Hand Tool Assembly 2390076-1 for the 2.5mm Diameter Contact is the tool and die set shown in Figure 1. The tool consists of the SDE-SA Frame Assembly 9-1478240-0 (instruction sheet [408-8851](#)) and the die assembly listed in Figure 1. This tool is used to crimp the terminal part numbers listed in Table 1.

Table 1: Crimping specifications

| Crimp tooling | | Terminal P/N | Cable | | Wire insulation mm [in.] | |
|---------------|-------------------|------------------|---------------------------------|----------------------|--------------------------|---------------------|
| SDE-SA tool | Die assembly only | | Wire size mm ² [AWG] | Number of conductors | Diameter | Strip length |
| 2390076-1 | 2390076-2 | 963706 963702 | 2.50 [13] | 1 | 2.20-3.00 [.087-.118] | 5.2-5.8 [.205-.228] |
| | | | 2.00 [14] | | | |
| | | | 1.50 [15] | | | |



NOTE

Dimensions in this instruction sheet are in millimeters with [inches in brackets]. Figures are for reference only and are not drawn to scale.

Read these instructions thoroughly before crimping connectors.

2. DESCRIPTION

The tool frame features two jaws, a handle, a ratchet adjustment wheel, and an emergency ratchet release. The die set consists of a crimper (upper die) and an anvil (lower die). The tool frame holds a die assembly with three crimping chambers (see Figure 1). Die-retaining pins and die-retaining screws are used to secure the dies in the tool frame.

The tool features a ratchet and an adjustment wheel with a range of settings. The ratchet ensures that the tool has completed the cycle and does not release until the handles have been **fully** closed, unless the emergency ratchet release is rotated to manually release the ratchet. The adjustment wheel controls the amount of handle pressure exerted on the dies during the crimping procedure.



CAUTION

The dies bottom before the ratchet releases. This feature ensures maximum tensile performance of the crimp. **Do not** re-adjust the ratchet unless you have verified that the crimp height is incorrect (see section 8, *ADJUSTING THE RATCHET*).

3. INSTALLING THE DIE SET AND LOCATOR ASSEMBLY

1. Open the tool handles and remove the two die-retaining screws from the tool jaws (see Figure 1).
2. Place the wire anvil and insulation anvil so that their chamfered sides and the marked surfaces face outward when mounted in the moving jaw of the tool frame.
3. Insert the two die-retaining pins.
4. Insert the short die-retaining screw through the jaw and through the anvil dies. Tighten the screw just enough to hold the die in place. Do not tighten the screw completely.
5. Place the wire crimper and insulation crimper so that the chamfered sides and the marked surface face outward when mounted in the stationary jaw of the tool frame.
6. Insert the two die-retaining pins.
7. Insert the long die-retaining screw through the jaw and through the crimper dies. Tighten the screw just enough to hold the die in place. Do not tighten the screw completely.
8. Carefully close the tool handles, making sure the anvil and crimper align properly. Continue closing the tool handles until the ratchet in the tool frame has engaged sufficiently to hold the anvil and crimper in place.
9. Tighten both die-retaining screws.
10. Place the locator assembly over the end of the long screw and position the locator assembly against the side of the tool jaw.
11. Place the nut onto the end of the long screw and tighten the nut enough to hold the locator assembly in place, while still allowing the locator blade to slide up and down.

4. REMOVING THE DIE SET AND LOCATOR ASSEMBLY

1. Close the tool handles until the ratchet releases.
2. Remove the nut, the locator assembly, the two die-retaining screws, and the four die-retaining pins.
3. Slide the anvil and crimper out of the tool jaws.

**NOTE**

The ratchet release has detents with audible clicks as the handles are closed. The ratchet releases on the sixth click.

5. CRIMPING



NOTE

The tool is provided with a crimp adjustment feature. Initially, the crimp height should be verified as specified in Figure 4. Refer to section 7, *INSPECTING THE CRIMP HEIGHT*, and section 8, *ADJUSTING THE RATCHET*, to verify crimp height before using the tool to crimp contacts and wire sizes.

1. Refer to Table 1 and select wire of the specified size and insulation diameter.
2. Strip the wire to the length indicated. Do not nick or cut wire strands.
3. Select an applicable contact and identify the appropriate crimp section according to the wire size markings on the tool.
4. Hold the tool so that the back (wire side) is facing you. (See Figure 2.) Squeeze the tool handles together and allow them to open fully.
5. Holding the contact by the mating end, insert the contact through the front of the tool and into the appropriate crimp section.
6. Position the contact so that the U of the wire barrel faces the top of the tool.
7. Place the contact up into the nest so that the wire barrel is against the spring-loaded locator.



CAUTION

Make sure that both sides of the wire barrel are started evenly into the crimping section. **Do not** attempt to crimp an improperly positioned contact.

8. Close the handles of the tool until the contact is lightly held by the die set, but is not deformed to the point where the wire cannot enter freely.
9. Insert the wire into the crimp barrel of the contact until it butts against the spring-loaded locator.
10. While holding the wire in place, fully cycle the tool until the ratchet releases and allows the handle to open.

Figure 2: Crimping



- | | |
|--|------------------------------------|
| 1 Die assembly (for reference only) | 5 Locator in wire stop slot |
| 2 Locator | 6 Contact (typical) |
| 3 Back of tool (wire side) | 7 Strip length |
| 4 Wire | 8 Wire inserted to stop |

6. ADJUSTING THE CONTACT SUPPORT

The contact support is preset prior to shipment, but minor adjustments might be necessary. Refer to Figure 3 and proceed as follows:

1. Make a sample crimp and determine whether the contact is straight, bending upward, or bending downward.
2. If adjustment is required, loosen the screw that holds the contact support onto the locator assembly.
3. Place a contact with wire into the proper nest and close the handles until the ratchet reaches the sixth click, or until the contact support touches the contact.
4. Move the contact support as required to eliminate the bending of the contact.
5. Tighten the screw and close the handles until the ratchet releases.
6. Remove and inspect the contact.
7. Make another sample crimp. If the contact is still bent during crimping, repeat the adjustment procedure.

Figure 3: Contact support adjustment



- 1** Contact support
- 2** Contact support screw
- 3** Die assembly (for reference only)

7. INSPECTING THE CRIMP HEIGHT

Crimp height inspection is performed using a micrometer with a modified anvil, commonly referred to as a crimp-height comparator. TE Connectivity does not manufacture or market crimp height comparators. Detailed information on obtaining and using crimp-height comparators can be found in instruction sheet [408-7424](#).

1. Refer to Table 1 and select a wire (maximum size) for each crimp section listed.
2. Refer to section 5, CRIMPING, and crimp the contacts accordingly.
3. Using a crimp height comparator, measure the wire barrel crimp height listed in Table 2.
 - If the crimp height conforms to that shown in the table, the tool is considered dimensionally correct.
 - If not, adjust the tool. Refer to section 8, ADJUSTING THE RATCHET.



CAUTION

Do not use damaged product. If a damaged contact is evident, replace it. Do not re-terminate contacts.

Figure 4: Crimp height

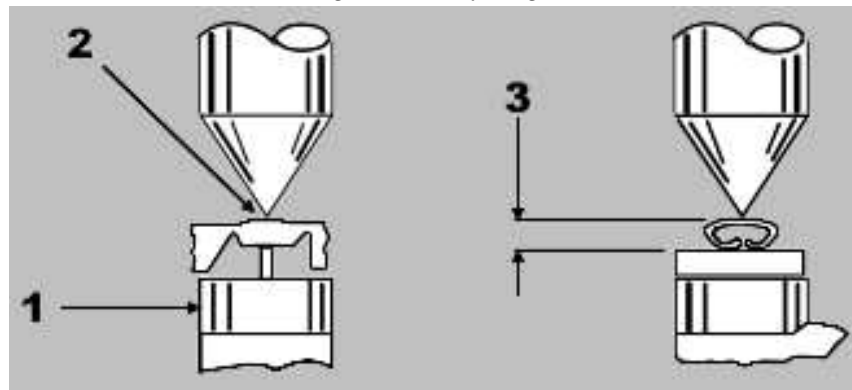

- 1 Modified anvil
- 2 Position point on center of wire barrel opposite seam
- 3 Crimp height (see Table 2)

Table 2: Crimp height specifications

| Die assembly | Wire size max mm ² [AWG] | Crimp section (wire size markings) | Crimp height mm [in.] |
|--------------|-------------------------------------|------------------------------------|-----------------------|
| 2390076-2 | 2.50 [13] | 2.50mm ² | 1.81±0.05 [.071±.002] |
| | 2.00 [14] | 2.00mm ² | 1.71±0.05 [.067±.002] |
| | 1.50 [15] | 1.50mm ² | 1.57±0.05 [.062±.002] |

8. ADJUSTING THE RATCHET

The ratchet is preset prior to shipment, but it is important to verify the crimp height using a micrometer or caliper. Use and wear can cause the tool to go out of adjustment. Inspect the crimp height and adjust the ratchet, if necessary, on a regular basis. Refer to Figure 5 and adjust as follows:

- If the crimp height is larger than recommended, remove the ratchet wheel adjustment screw and rotate the adjustment wheel counterclockwise (+) to a higher setting. Reinstall the screw. Repeat as required.
- If the crimp height is smaller than recommended, remove the ratchet wheel adjustment screw and rotate the adjustment wheel clockwise (-) to a lower setting. Reinstall the screw. Repeat as required.
- If the crimp height cannot be made to conform to the recommended crimp height, replace the tool or die set. See section 10, REPLACEMENT AND REPAIR.

Figure 5: Ratchet adjustment



- 1 Adjustment screw
2 Ratchet adjustment wheel

9. MAINTENANCE AND INSPECTION

9.1. Maintenance

- Remove dust, moisture, and other contaminants with a clean, soft brush or soft, lint-free cloth. **Do not** use objects that could damage the dies or tool.
- When the tool is not in use, keep the handles closed to prevent objects from becoming lodged in the dies. Store the tool in a clean, dry area.
- Remove all lubrication and accumulated film by immersing the dies in a suitable commercial degreaser.

9.2. Visual inspection

- Inspect the tool and dies on a regular basis to ensure that they are not worn or damaged.
- Make sure that the die retaining screws are properly secured.
- Inspect the crimping chambers of the die assembly for flattened, chipped, worn, or broken areas. If damage or abnormal wear is evident, replace the dies. Refer to section 10, REPLACEMENT AND REPAIR.

10. REPLACEMENT AND REPAIR

If the dies are damaged or worn excessively, they must be replaced. Order replacement dies through your TE representative. You can also order parts by any of the following methods:

- Go to TE.com and click the **Shop TE** link at the top of the page.
- Call 800-522-6752.
- Write to:

CUSTOMER SERVICE (038-035)
TE CONNECTIVITY CORPORATION
PO BOX 3608
HARRISBURG PA 17105-3608

For customer repair services, call 800-522-6752.

11. REVISION SUMMARY

Revisions to this instruction sheet include:

Initial release