

**Data sheet | Item number: 285-137/999-950**

2-conductor ground terminal block; 35 mm<sup>2</sup>; suitable for Ex e II applications;  
lateral marker slots; only for DIN 35 x 15 rail; POWER CAGE CLAMP; 35,00  
mm<sup>2</sup>; green-yellow

[www.wago.com/285-137/999-950](http://www.wago.com/285-137/999-950)

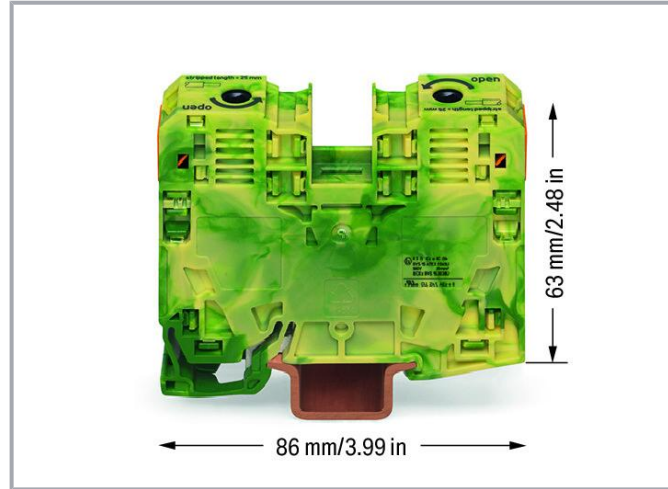

**Data**

**Electrical data**

**Ratings per IEC/EN**

Ratings per

IEC/EN 60947-7-2

**Ex information**

Reference hazardous areas

See "Downloads – Documentation – Additional Information:  
Technical Section; Technical Explanations"

**Connection data**

Connection points	2
Total number of potentials	1
Number of levels	1
Number of jumper slots	2

Subject to changes. Please also observe the further product documentation!

WAGO GmbH & Co. KG  
Hansastr. 27  
32423 Minden  
Phone: +49571 887-0 | Fax: +49571 887-169  
Email: [info.de@wago.com](mailto:info.de@wago.com) | Web: [www.wago.com](http://www.wago.com)

Do you have any questions about our products?  
We are always happy to take your call at +49 (571) 887-44222.

## Connection 1

Connection technology	POWER CAGE CLAMP
Actuation type	Operating tool
Connectable conductor materials	Copper
Solid conductor	6 ... 35 mm <sup>2</sup> / 8 ... 2 AWG
Stranded conductor	6 ... 35 mm <sup>2</sup> / 8 ... 2 AWG
Fine-stranded conductor	6 ... 35 mm <sup>2</sup> / 8 ... 2 AWG
Fine-stranded conductor; with insulated ferrule	6 ... 35 mm <sup>2</sup> / 8 ... 2 AWG
Fine-stranded conductor; with uninsulated ferrule	6 ... 35 mm <sup>2</sup> / 8 ... 2 AWG
Strip length	25 mm / 0.98 inches
Wiring direction	Side-entry wiring

## Physical data

Width	16 mm / 0.63 inches
Height	86 mm / 3.386 inches
Depth from upper-edge of DIN-rail	63 mm / 2.48 inches

## Mechanical Data

Mounting type	DIN-rail 35 x 15; 2.3 mm thick; copper
Mounting (note)	only suitable for DIN 35 x 15 copper rail; 2.3 mm thick
Marking level	Side marking

## Material Data

Note (material data)	Information on material specifications can be found here
Color	green-yellow
Material group	I
Insulation material	Polyamide (PA66)
Flammability class per UL94	V0
Fire load	0.154 MJ
Weight	108.2 g

## Environmental requirements

Processing temperature	-35 ... +85 °C
------------------------	----------------

Subject to changes. Please also observe the further product documentation!

Continuous operating temperature

-60 ... +105 °C

### Commercial data

eCl@ss 10.0	27-14-11-41
eCl@ss 9.0	27-14-11-41
ETIM 8.0	EC000901
ETIM 7.0	EC000901
PU (SPU)	15 pcs
Packaging type	box
Country of origin	PL
GTIN	4055143418553
Customs tariff number	85369010000





### Environmental Product Compliance

RoHS Compliance Status

Compliant, No Exemption

### Approvals / Certificates

#### General approvals

Logo	Approval	Additional Approval Text	Certificate name
	CCA DEKRA Certification B.V.	EN 60947	NTR NL-7707
	CCC CNEX	GB/T 3836.3	2020312313000177 (Ex eb IIC Gb, Ex eb I Mb)
	CSA DEKRA Certification B.V.	C22.2	154112
	KEMA/KEUR DEKRA Certification B.V.	EN 60947	71-105562
	UL Underwriters Laboratories Inc.	UL 1059	E45172

Subject to changes. Please also observe the further product documentation!

WAGO GmbH &amp; Co. KG

Hansastr. 27

32423 Minden

Phone: +49571 887-0 | Fax: +49571 887-169

Email: [info.de@wago.com](mailto:info.de@wago.com) | Web: [www.wago.com](http://www.wago.com)

Do you have any questions about our products?

We are always happy to take your call at +49 (571) 887-44222.





## Declarations of conformity and manufacturer's declarations

Logo	Approval	Additional Approval Text	Certificate name
	EU-Declaration of Conformity WAGO GmbH & Co. KG	-	-
	UK-Declaration of Conformity WAGO GmbH & Co. KG	-	-

## Approvals for marine applications

Logo	Approval	Additional Approval Text	Certificate name
	ABS American Bureau of Shipping	EN 60947	20- HG1941090- PDA

## Approvals for hazardous areas

Logo	Approval	Additional Approval Text	Certificate name
	AEx Underwriters Laboratories Inc.	-	E185892 (AEx eb II C resp. Ex eb II C)
	ATEX Physikalisch Technische Bundesanstalt	EN 60079-0	PTB 98 ATEX 3134 U (II 2 G Ex eb IIC Gb or I M 2 Ex eb I Mb)
	CCC CNEX	GB/T 3836.3	2020312313000177 (Ex eb IIC Gb, Ex eb I Mb)
	EAC Brjansker Zertifizierungsstelle	TP TC 012/2011	RU C-DE.AM02.B. 00127/19 (Ex e IIC Gb U)
	IECEX Physikalisch Technische Bundesanstalt	IEC 60079-0	IECEX PTB 16.0001U (Ex eb IIC Gb or Ex eb I Mb)

Subject to changes. Please also observe the further product documentation!

## Optional accessories

### Jumpers

#### Jumper



**Item no.: 285-435**  
Jumper; insulated; gray

[www.wago.com/285-435](http://www.wago.com/285-435)

### Carrier rail

#### Mounting accessories



**Item no.: 210-197**  
Steel carrier rail; 35 x 15 mm; 1.5 mm thick; 2 m long; slotted; similar to EN 60715; silver-colored

[www.wago.com/210-197](http://www.wago.com/210-197)



**Item no.: 210-198**  
Copper carrier rail; 35 x 15 mm; 2.3 mm thick; 2 m long; unslotted; according to EN 60715; copper-colored

[www.wago.com/210-198](http://www.wago.com/210-198)

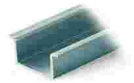

**Item no.: 210-506**  
Steel carrier rail; 35 x 15 mm; 1.5 mm thick; 2 m long; unslotted; galvanized; similar to EN 60715; silver-colored

[www.wago.com/210-506](http://www.wago.com/210-506)



**Item no.: 210-508**  
Steel carrier rail; 35 x 15 mm; 1.5 mm thick; 2 m long; slotted; galvanized; similar to EN 60715; silver-colored

[www.wago.com/210-508](http://www.wago.com/210-508)

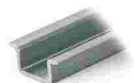

**Item no.: 210-118**  
Steel carrier rail; 35 x 15 mm; 2.3 mm thick; 2 m long; unslotted; according to EN 60715; silver-colored

[www.wago.com/210-118](http://www.wago.com/210-118)



**Item no.: 210-114**  
Steel carrier rail; 35 x 15 mm; 1.5 mm thick; 2 m long; unslotted; similar to EN 60715; silver-colored

[www.wago.com/210-114](http://www.wago.com/210-114)

### Mounting

#### Mounting accessories



**Item no.: 249-117**  
Screwless end stop; 10 mm wide; for DIN-rail 35 x 15 and 35 x 7.5; gray

[www.wago.com/249-117](http://www.wago.com/249-117)



**Item no.: 249-197**  
Screwless end stop; 14 mm wide; for DIN-rail 35 x 15 and 35 x 7.5; gray

[www.wago.com/249-197](http://www.wago.com/249-197)

### Marking accessories

#### Marking strip



**Item no.: 2009-110**  
Marking strips; for Smart Printer; on reel; not stretchable; plain; snap-on type; white

[www.wago.com/2009-110](http://www.wago.com/2009-110)

#### Marker carrier

Subject to changes. Please also observe the further product documentation!



**Item no.: 285-442**  
Adaptor; gray

[www.wago.com/285-442](http://www.wago.com/285-442)

Marker



**Item no.: 2009-115/000-002**  
WMB-Inline; for Smart Printer; 1500 pieces on roll; stretchable 5 - 5.2 mm; plain; snap-on type; yellow

[www.wago.com/2009-115/000-002](http://www.wago.com/2009-115/000-002)



**Item no.: 2009-115/000-007**  
WMB-Inline; for Smart Printer; 1500 pieces on roll; stretchable 5 - 5.2 mm; plain; snap-on type; gray

[www.wago.com/2009-115/000-007](http://www.wago.com/2009-115/000-007)



**Item no.: 2009-115/000-017**  
WMB-Inline; for Smart Printer; 1500 pieces on roll; stretchable 5 - 5.2 mm; plain; snap-on type; light green

[www.wago.com/2009-115/000-017](http://www.wago.com/2009-115/000-017)



**Item no.: 2009-115/000-023**  
WMB-Inline; for Smart Printer; 1500 pieces on roll; stretchable 5 - 5.2 mm; plain; snap-on type; green

[www.wago.com/2009-115/000-023](http://www.wago.com/2009-115/000-023)



**Item no.: 2009-115/000-024**  
WMB-Inline; for Smart Printer; 1500 pieces on roll; stretchable 5 - 5.2 mm; plain; snap-on type; violet

[www.wago.com/2009-115/000-024](http://www.wago.com/2009-115/000-024)



**Item no.: 2009-115**  
WMB-Inline; for Smart Printer; 1500 pieces on roll; stretchable 5 - 5.2 mm; plain; snap-on type; white

[www.wago.com/2009-115](http://www.wago.com/2009-115)



**Item no.: 793-5501/000-007**  
WMB marking card; as card; for terminal block width 5 - 17.5 mm; stretchable 5 - 5.2 mm; plain; snap-on type; gray

[www.wago.com/793-5501/000-007](http://www.wago.com/793-5501/000-007)



**Item no.: 793-5501/000-012**  
WMB marking card; as card; for terminal block width 5 - 17.5 mm; stretchable 5 - 5.2 mm; plain; snap-on type; orange

[www.wago.com/793-5501/000-012](http://www.wago.com/793-5501/000-012)



**Item no.: 793-5501/000-014**  
WMB marking card; as card; for terminal block width 5 - 17.5 mm; stretchable 5 - 5.2 mm; plain; snap-on type; brown

[www.wago.com/793-5501/000-014](http://www.wago.com/793-5501/000-014)



**Item no.: 793-5501/000-017**  
WMB marking card; as card; for terminal block width 5 - 17.5 mm; stretchable 5 - 5.2 mm; plain; snap-on type; light green

[www.wago.com/793-5501/000-017](http://www.wago.com/793-5501/000-017)

**Item no.: 793-5501/000-023**

Subject to changes. Please also observe the further product documentation!



WMB marking card; as card; for terminal block width 5 - 17.5 mm; stretchable 5 - 5.2 mm; plain; snap-on type; green [www.wago.com/793-5501/000-023](http://www.wago.com/793-5501/000-023)



**Item no.: 793-5501/000-024**  
WMB marking card; as card; for terminal block width 5 - 17.5 mm; stretchable 5 - 5.2 mm; plain; snap-on type; violet [www.wago.com/793-5501/000-024](http://www.wago.com/793-5501/000-024)



**Item no.: 793-501/000-002**  
WMB marking card; as card; not stretchable; plain; snap-on type; yellow [www.wago.com/793-501/000-002](http://www.wago.com/793-501/000-002)



**Item no.: 793-501/000-007**  
WMB marking card; as card; not stretchable; plain; snap-on type; gray [www.wago.com/793-501/000-007](http://www.wago.com/793-501/000-007)



**Item no.: 793-501/000-017**  
WMB marking card; as card; not stretchable; plain; snap-on type; light green [www.wago.com/793-501/000-017](http://www.wago.com/793-501/000-017)



**Item no.: 793-501/000-012**  
WMB marking card; as card; not stretchable; plain; snap-on type; orange [www.wago.com/793-501/000-012](http://www.wago.com/793-501/000-012)



**Item no.: 793-501/000-023**  
WMB marking card; as card; not stretchable; plain; snap-on type; green [www.wago.com/793-501/000-023](http://www.wago.com/793-501/000-023)



**Item no.: 793-501/000-006**  
WMB marking card; as card; not stretchable; plain; snap-on type; blue [www.wago.com/793-501/000-006](http://www.wago.com/793-501/000-006)



**Item no.: 793-501/000-005**  
WMB marking card; as card; not stretchable; plain; snap-on type; red [www.wago.com/793-501/000-005](http://www.wago.com/793-501/000-005)



**Item no.: 793-501**  
WMB marking card; as card; not stretchable; plain; snap-on type; white [www.wago.com/793-501](http://www.wago.com/793-501)



**Item no.: 793-501/000-024**  
WMB marking card; as card; not stretchable; plain; snap-on type; violet [www.wago.com/793-501/000-024](http://www.wago.com/793-501/000-024)

Subject to changes. Please also observe the further product documentation!



**Item no.: 793-5501/000-005**

WMB marking card; as card; for terminal block width 5 - 17.5 mm; stretchable 5 - 5.2 mm; plain; snap-on type; red [www.wago.com/793-5501/000-005](http://www.wago.com/793-5501/000-005)



**Item no.: 793-5501/000-002**

WMB marking card; as card; for terminal block width 5 - 17.5 mm; stretchable 5 - 5.2 mm; plain; snap-on type; yellow [www.wago.com/793-5501/000-002](http://www.wago.com/793-5501/000-002)



**Item no.: 793-5501/000-006**

WMB marking card; as card; for terminal block width 5 - 17.5 mm; stretchable 5 - 5.2 mm; plain; snap-on type; blue [www.wago.com/793-5501/000-006](http://www.wago.com/793-5501/000-006)



**Item no.: 793-5501**

WMB marking card; as card; for terminal block width 5 - 17.5 mm; stretchable 5 - 5.2 mm; plain; snap-on type; white [www.wago.com/793-5501](http://www.wago.com/793-5501)



**Item no.: 2009-115/000-012**

WMB-Inline; for Smart Printer; 1500 pieces on roll; stretchable 5 - 5.2 mm; plain; snap-on type; orange [www.wago.com/2009-115/000-012](http://www.wago.com/2009-115/000-012)



**Item no.: 2009-115/000-006**

WMB-Inline; for Smart Printer; 1500 pieces on roll; stretchable 5 - 5.2 mm; plain; snap-on type; blue [www.wago.com/2009-115/000-006](http://www.wago.com/2009-115/000-006)



**Item no.: 2009-115/000-005**

WMB-Inline; for Smart Printer; 1500 pieces on roll; stretchable 5 - 5.2 mm; plain; snap-on type; red [www.wago.com/2009-115/000-005](http://www.wago.com/2009-115/000-005)

Group marker carrier



**Item no.: 249-105**

Group marker carrier; gray [www.wago.com/249-105](http://www.wago.com/249-105)

Voltage tap

Power tap



**Item no.: 283-407**

Power tap; with 500 mm cable; for 16 mm<sup>2</sup> (283/783 Series) and 35 mm<sup>2</sup>; gray [www.wago.com/283-407](http://www.wago.com/283-407)



**Item no.: 285-427**

Power tap; for 35 mm<sup>2</sup> high-current tbs; Module width 8 mm; 6,00 mm<sup>2</sup>; gray [www.wago.com/285-427](http://www.wago.com/285-427)

Ferrule

Ferrule



**Item no.: 216-413**

Ferrule; Sleeve for 25 mm<sup>2</sup> / AWG 4; uninsulated; electro-tin plated; electrolytic copper; gastight crimped; acc. to DIN 46228, Part 1/08.92; silver-colored [www.wago.com/216-413](http://www.wago.com/216-413)



**Item no.: 216-414**

Subject to changes. Please also observe the further product documentation!



Ferrule; Sleeve for 35 mm<sup>2</sup> / AWG 2; uninsulated; electro-tin plated; electrolytic copper; gastight crimped; acc. to DIN 46228, Part 1/08.92; silver-colored

[www.wago.com/216-414](http://www.wago.com/216-414)

**Tool**

Operating tool



**Item no.: 210-721**

Operating tool; Blade: 5.5 x 0.8 mm; with a partially insulated shaft; multicoloured

[www.wago.com/210-721](http://www.wago.com/210-721)

**Cover**

Cover



**Item no.: 285-421**

Finger guard; touchproof cover protects unused conductor entries; for 35 mm<sup>2</sup> high-current tbs; yellow

[www.wago.com/285-421](http://www.wago.com/285-421)

**Protective warning marker**

Cover



**Item no.: 285-420**

Protective warning marker; with high-voltage symbol, black; yellow

[www.wago.com/285-420](http://www.wago.com/285-420)

**Downloads**

**Documentation**

**Bid Text**

285-137/999-950 X81 - Datei	2019 Feb 19	xml 3.2 kB	Download
285-137/999-950 doc - Datei	2018 Jan 4	doc 24.1 kB	Download

**Additional Information**

Technical Section Technical explanations		pdf 2.2 MB	Download
---	--	---------------	----------

**CAD/CAE-Data**

**CAE data**

EPLAN Data Portal 285-137/999-950		URL	Download
EPLAN Data Portal 285-137/999-950		URL	Download

Subject to changes. Please also observe the further product documentation!

## Environmental Product Compliance

### Compliance Search

Environmental Product Compliance 285-137/999-950

URL

Download

2-conductor ground terminal block; 35 mm<sup>2</sup>; suitable for Ex e II applications; lateral marker slots; only for DIN 35 x 15 rail; POWER CAGE CLAMP; 35,00 mm<sup>2</sup>; green-yellow

---

## Installation Notes

### Installation



Removing a terminal block from the assembly (to the left or to the right).



### Grounding foot:

Ground conductor terminal blocks (limited to max. 120 mm<sup>2</sup>/250 kcmil per EN 60947-7-2) must be snapped onto a 2.3 mm thick copper DIN-rail.

### Conductor termination

Subject to changes. Please also observe the further product documentation!

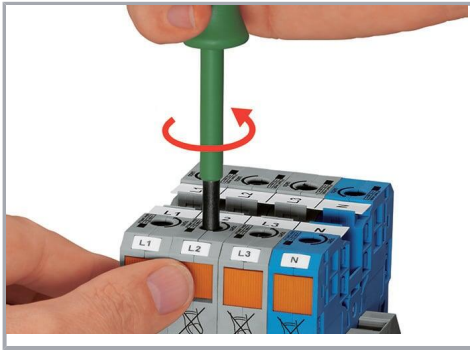

**Conductor termination – step 1:**

Rotate the operating tool (5.5 mm blade width) counter-clockwise. Next, push in the orange locking tab. The clamp is locked open for hands-free wiring.

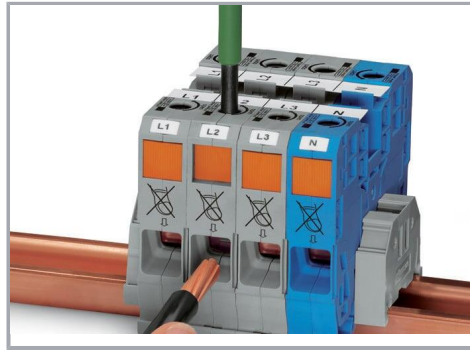

**Conductor termination – step 2:**

Insert a stripped conductor into the clamping unit until it hits the backstop. Hold in this position.

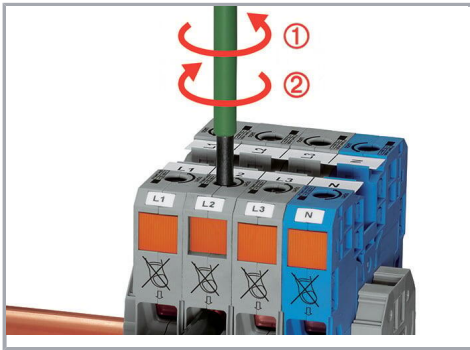

**Conductor termination – step 3:**

A short counter-clockwise rotation closes the clamp, securing the conductor. When unlocked, allow the operating tool to rotate clockwise to securely terminate the conductor.



Side-entry wiring means that even larger conductors, which have limited flexibility, can be easily connected.

**Commoning**

Subject to changes. Please also observe the further product documentation!

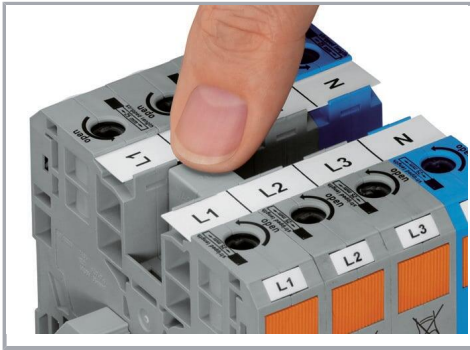

Commoning adjacent terminal blocks using a centrally positioned push-in jumper.



Slide the marking strip laterally to remove the jumper.

### Power tap

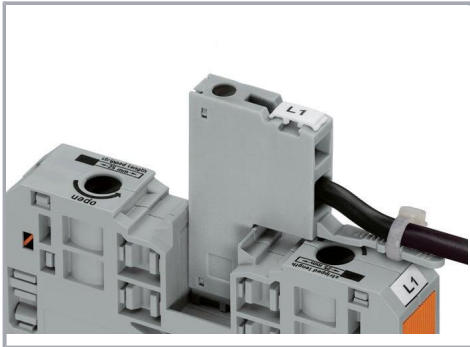

The power tap is inserted into the jumper contact slot. It can be fitted with a strain relief plate.

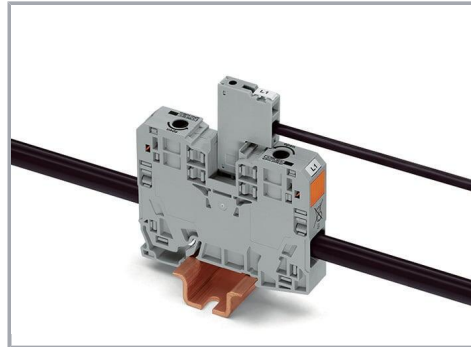

Power tap inserted in a jumper contact slot

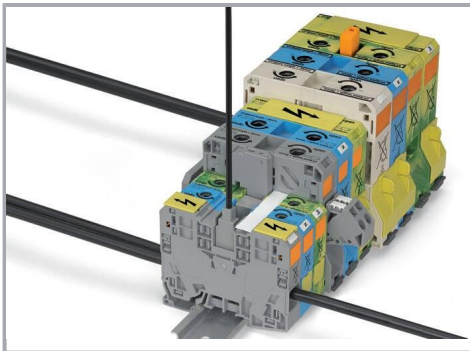

Always push voltage tap (283-407) down into the terminal block until fully inserted!

### Testing

Subject to changes. Please also observe the further product documentation!

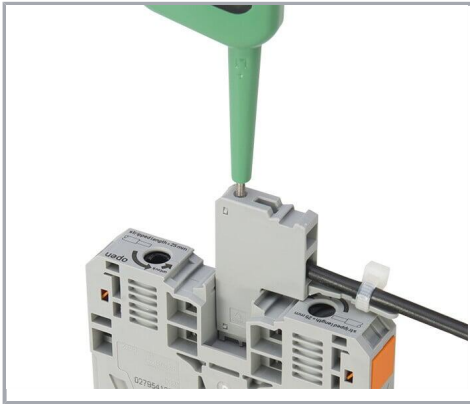

Testing with test plug adapter (283-404).

### Testing

Voltage measurements can be performed, e.g., using a 2-pole voltage tester (206-707).

### Marking

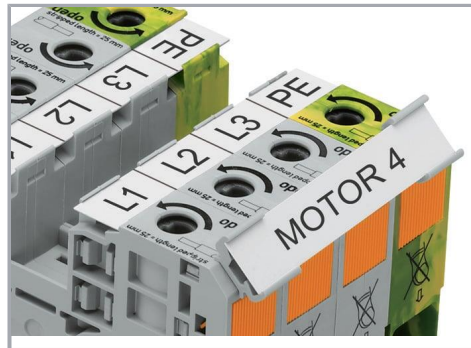
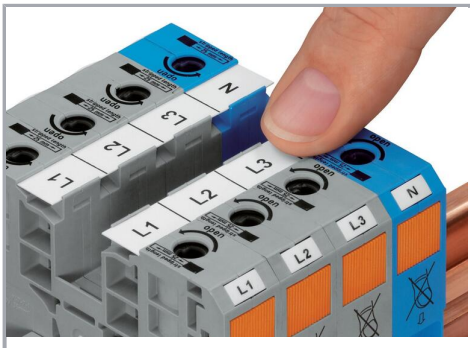

WMB markers or self-adhesive, printable marking strips can be accommodated on 35, 50 and 95 mm<sup>2</sup> high-current terminal blocks.

Marker carrier (285-442) for marking strips (2009-110) or 2 WMB markers for 285-13x, 285-15x and 285-19x Terminal Blocks

Subject to changes. Please also observe the further product documentation!