

## Item description

### Female connector/socket WINSTA® MIDI 5-pole

The WINSTA® MIDI female connector/socket rated current 25 A provides the foundation for installation of solid and fine-stranded conductors. The pluggable installation connectors with spring pressure connection technology work completely without screw connections. They allow fast, efficient, error-free installation in numerous applications. The coding options reduce installation errors, allowing fast, maintenance-free wiring of all components. The pluggable installation connector is protected against ingress by solid objects in accordance with protection type IP20 (When mated and secured with a strain relief housing: IP2xC (These compact connectors are not designed for use in open, easily accessible areas!)). B coding enables the WINSTA® MIDI pluggable installation connectors to be used for application control in automation, mechanical engineering and robotics. This pluggable installation connector can be used for electrical currents up to 25 A. Thus the product is ideally suitable for high power loads. The WINSTA® MIDI Pluggable Connection System with Push-in CAGE CLAMP® spring pressure connection technology facilitates safe electrification. Thanks to the built-in test slot, it is possible to check connections even when they are plugged in. This saves time, labor, and money.

Subject to changes. Please also observe the further product documentation!



## Push-in CAGE CLAMP® spring pressure connection technology – pluggable installation instead of laborious screw connections!

The WINSTA® Pluggable Connection System allows pluggable electrical installation. This significantly reduces the need for servicing and lowers costs. Now you can also lower installation costs without compromising quality and safety: The WINSTA® MIDI pluggable installation connector with protection against mismatching eliminates the need for servicing and prevents unnecessary downtime.

- pluggable installation connectors with protection against mismatching
- for automation controllers
- with B coding for use in automation of processes, such as lighting technology, for instance
- custom-engineered solutions
- fast, secure installation

### Data

#### Notes

Variants:

Other pole markings

Other versions (or variants) can be requested from WAGO Sales or configured at <https://configurator.wago.com/>.

### Electrical data

#### Ratings per IEC/EN

Ratings per	IEC/EN 60664-1
Nominal voltage (III/3)	400 V
Rated impulse voltage (III/3)	6 kV
Rated current	25 A
Note (rated current)	25 A for 3-pole load 20 A for 4- and 5-pole load
Legend (ratings)	(III / 3) ≙ Overvoltage category III / Pollution degree 3

#### Ratings per UL 1977

Note for the US market

Some versions may also be used for current interruption in accordance with the UL certificate in select applications with currents below 16 A and voltages up to 600 V. For further information, please contact your local sales office.

Rated voltage (UL 1977)	600 V
-------------------------	-------

Subject to changes. Please also observe the further product documentation!

WAGO GmbH & Co. KG

Hansastr. 27

32423 Minden

Phone: +49571 887-0 | Fax: +49571 887-169

Email: [info.de@wago.com](mailto:info.de@wago.com) | Web: [www.wago.com](http://www.wago.com)

Do you have any questions about our products?

We are always happy to take your call at +49 (571) 887-44222.

Rated current UL 1977

23 A

## General

Note on contact resistance

approx. 1 mΩ of contact resistance  
approx. 0.25 mΩ contact transition plug/socket

## Connection data

Connection points

10

Total number of potentials

5

## Connection 1

Connection technology

Push-in CAGE CLAMP®

Actuation type

Operating tool  
Push-in

Nominal cross-section

4 mm<sup>2</sup> / 12 AWG

Solid conductor

0.5 ... 4 mm<sup>2</sup> / 20 ... 12 AWG

Solid conductor; push-in termination

1.5 ... 4 mm<sup>2</sup> / 16 ... 12 AWG

Stranded conductor

0.5 ... 2.5 mm<sup>2</sup> / 20 ... 14 AWG

Fine-stranded conductor

0.5 ... 4 mm<sup>2</sup> / 20 ... 12 AWG

Fine-stranded conductor; with insulated ferrule

0.25 ... 1.5 mm<sup>2</sup> / 20 ... 16 AWG

Fine-stranded conductor; with uninsulated ferrule

0.25 ... 2.5 mm<sup>2</sup> / 20 ... 14 AWG

Fine-stranded conductor; with ferrule; push-in termination

1.5 mm<sup>2</sup> / 16 AWG

Strip length

9 mm / 0.35 inches

Pole number

5

Conductor entry direction to mating direction

0°

## Physical data

Pin spacing

10 mm / 0.394 inches

Width

50 mm / 1.969 inches

Height

12.9 mm / 0.508 inches

Depth

37.5 mm / 1.476 inches

## Mechanical Data

Application

Control technology

Coding

B

Variable coding

Yes

Subject to changes. Please also observe the further product documentation!

WAGO GmbH & Co. KG

Hansastr. 27

32423 Minden

Phone: +49571 887-0 | Fax: +49571 887-169

Email: [info.de@wago.com](mailto:info.de@wago.com) | Web: [www.wago.com](http://www.wago.com)

Do you have any questions about our products?

We are always happy to take your call at +49 (571) 887-44222.



Marking	N $\nabla$ L 2L 1L
Potential marking	N $\nabla$ L 2L 1L
Mating force of a plug-in connection	approx. 20 ... 70 N (depending on pole number)
Retention force of a plug-in connection	Locked: > 80 N
Unmating force of a plug-in connection	Unlocked: approx. 20 ... 70 N (depending on pole number)
Number of mating cycles	200, without resistive load
Protection type	IP20; When mated and secured with a strain relief housing: IP2xC (These compact connectors are not designed for use in open, easily accessible areas!)

### Plug-in connection

Contact type (pluggable connector)	Female connector/socket
Connector (connection type)	for conductor
Mismating protection	Yes
Note on mismating protection	All <i>WINSTA</i> <sup>®</sup> components are 100% protected against mismating when: a.) plugging different numbers of poles b.) plugging while rotated 180 c.) plugging while laterally staggered d.) plugging one pole
Locking lever	Can be retrofitted
Locking of plug-in connection	locking lever
Note on locking system	All connectors for mounted installations (snap-in versions for lighting fixtures or devices, all types of PCB and distribution connectors) are factory-equipped with locking levers to ensure plugs and sockets are securely locked. Additional locking levers are only required for flying leads (plug/socket).

### Material Data

Note (material data)	Information on material specifications can be found here
Color	gray
Cover color	gray
Material group	I
Insulation material	Polyamide (PA66)
Flammability class per UL94	V0
Clamping spring material	Chrome-nickel spring steel (CrNi)
Contact material	Copper or copper alloy; surface-treated
Contact plating	Tin

Subject to changes. Please also observe the further product documentation!

Fire load	0.407 MJ
Weight	16.1 g

### Environmental requirements

Processing temperature	-5 ... +40 °C
Continuous operating temperature	-35 ... +85 °C
Note on continuous operating temperature	Insulating parts for temperatures ≤ 105 °C

### Commercial data

eCl@ss 10.0	27-44-06-05
eCl@ss 9.0	27-44-06-05
ETIM 8.0	EC002560
ETIM 7.0	EC002560
PU (SPU)	50 pcs
Packaging type	box
Country of origin	DE
GTIN	4050821486268
Customs tariff number	85366990990

### Environmental Product Compliance

RoHS Compliance Status	Compliant, No Exemption
------------------------	-------------------------

### Approvals / Certificates

#### General approvals

Logo	Approval	Additional Approval Text	Certificate name
	cURus Underwriters Laboratories Inc.	UL 1977	E45171

### Counterpart



Item no. 770-855/011-000/064-000  
Plug for PCBs; angled; 5-pole; Cod. B; gray

[www.wago.com/770-855/011-000/064-000](http://www.wago.com/770-855/011-000/064-000)

Subject to changes. Please also observe the further product documentation!

WAGO GmbH & Co. KG  
Hansastr. 27  
32423 Minden  
Phone: +49571 887-0 | Fax: +49571 887-169  
Email: [info.de@wago.com](mailto:info.de@wago.com) | Web: [www.wago.com](http://www.wago.com)

Do you have any questions about our products?  
We are always happy to take your call at +49 (571) 887-44222.



Item no. 770-255/064-000  
Plug; 5-pole; Cod. B; 4,00 mm<sup>2</sup>; gray

[www.wago.com/770-255/064-000](http://www.wago.com/770-255/064-000)



Item no. 770-755/064-000  
Snap-in plug; 5-pole; Cod. B; 4,00 mm<sup>2</sup>; gray

[www.wago.com/770-755/064-000](http://www.wago.com/770-755/064-000)



Item no. 770-855/064-000  
Plug for PCBs; straight; 5-pole; Cod. B; gray

[www.wago.com/770-855/064-000](http://www.wago.com/770-855/064-000)

## Required accessories

### Locking levers

#### Locking system



Item no.: 770-121  
Locking lever; for flying leads; for manual operation; white

[www.wago.com/770-121](http://www.wago.com/770-121)



Item no.: 770-131  
Locking lever; for flying leads; for tool operation; white

[www.wago.com/770-131](http://www.wago.com/770-131)



Item no.: 770-101  
Locking lever; for flying leads; for manual operation; black

[www.wago.com/770-101](http://www.wago.com/770-101)



Item no.: 770-111  
Locking lever; for flying leads; for tool operation; black

[www.wago.com/770-111](http://www.wago.com/770-111)

### Strain relief

#### Strain relief housing



Item no.: 770-505/021-000  
Strain relief housing; 5-pole; for 1 cable; 11.5 ... 16.5 mm; 71 mm; black

[www.wago.com/770-505/021-000](http://www.wago.com/770-505/021-000)



Item no.: 770-505/023-000  
Strain relief housing; 5-pole; for 2 cables; 5.0 ... 9.0 mm; 55 mm; black

[www.wago.com/770-505/023-000](http://www.wago.com/770-505/023-000)



Item no.: 770-505  
Strain relief housing; 5-pole; for 2 cables; 9.0 ... 13.0 mm; 55 mm; black

[www.wago.com/770-505](http://www.wago.com/770-505)

Subject to changes. Please also observe the further product documentation!

WAGO GmbH & Co. KG

Hansastr. 27

32423 Minden

Phone: +49571 887-0 | Fax: +49571 887-169

Email: [info.de@wago.com](mailto:info.de@wago.com) | Web: [www.wago.com](http://www.wago.com)

Do you have any questions about our products?

We are always happy to take your call at +49 (571) 887-44222.



Item no.: 770-515

Strain relief housing; 5-pole; for 2 cables; 9.0 ... 13.0 mm; 55 mm; white

[www.wago.com/770-515](http://www.wago.com/770-515)



Item no.: 770-515/023-000

Strain relief housing; 5-pole; for 2 cables; 5.0 ... 9.0 mm; 55 mm; white

[www.wago.com/770-515/023-000](http://www.wago.com/770-515/023-000)



Item no.: 770-515/021-000

Strain relief housing; 5-pole; for 1 cable; 11.5 ... 16.5 mm; 71 mm; white

[www.wago.com/770-515/021-000](http://www.wago.com/770-515/021-000)

## Optional accessories

### Tool

Operating tool



Item no.: 210-719

Operating tool; Blade: 2.5 x 0.4 mm; with a partially insulated shaft

[www.wago.com/210-719](http://www.wago.com/210-719)

### Cover

Cover



Item no.: 770-201

Lockout cap; 12-pole, separable; for sockets; Plastic; black

[www.wago.com/770-201](http://www.wago.com/770-201)



Item no.: 770-221

Lockout cap; 12-pole, separable; for sockets; Plastic; white

[www.wago.com/770-221](http://www.wago.com/770-221)



Item no.: 897-2005

Protective cap; Type4; for sockets and plugs; PVC; red

[www.wago.com/897-2005](http://www.wago.com/897-2005)

### Marking accessories

Marker



Item no.: 770-450/000-002

Marker card; Plastic; yellow

[www.wago.com/770-450/000-002](http://www.wago.com/770-450/000-002)



Item no.: 770-450/000-001

Marker card; Plastic; green

[www.wago.com/770-450/000-001](http://www.wago.com/770-450/000-001)

Subject to changes. Please also observe the further product documentation!

WAGO GmbH & Co. KG

Hansastr. 27

32423 Minden

Phone: +49571 887-0 | Fax: +49571 887-169

Email: [info.de@wago.com](mailto:info.de@wago.com) | Web: [www.wago.com](http://www.wago.com)

Do you have any questions about our products?

We are always happy to take your call at +49 (571) 887-44222.



**Item no.: 770-450/000-005**  
Marker card; Plastic; red

[www.wago.com/770-450/000-005](http://www.wago.com/770-450/000-005)



**Item no.: 770-450**  
Marker card; Plastic; white

[www.wago.com/770-450](http://www.wago.com/770-450)



**Item no.: 770-450/000-006**  
Marker card; Plastic; blue

[www.wago.com/770-450/000-006](http://www.wago.com/770-450/000-006)



**Item no.: 770-450/000-012**  
Marker card; Plastic; orange

[www.wago.com/770-450/000-012](http://www.wago.com/770-450/000-012)

## Mounting

Snap-in frame



**Item no.: 770-320**  
Snap-in frame; 5-pole; 1.0 ... 3.0 mm; black

[www.wago.com/770-320](http://www.wago.com/770-320)



**Item no.: 770-321**  
Snap-in frame; 5-pole; 0.5 ... 2.0 mm; black

[www.wago.com/770-321](http://www.wago.com/770-321)



**Item no.: 770-340**  
Snap-in frame; 5-pole; 1.0 ... 3.0 mm; white

[www.wago.com/770-340](http://www.wago.com/770-340)



**Item no.: 770-341**  
Snap-in frame; 5-pole; 0.5 ... 2.0 mm; white

[www.wago.com/770-341](http://www.wago.com/770-341)

## Downloads

### Documentation

#### Bid Text

Item number	Date	File type	Size	Action
770-245/064-000	2019 Feb 19	xml	3.0 kB	Download
X81 - Datei				
770-245/064-000	2015 Jun 8	doc		Download

Subject to changes. Please also observe the further product documentation!

WAGO GmbH & Co. KG  
Hansastr. 27  
32423 Minden  
Phone: +49571 887-0 | Fax: +49571 887-169  
Email: [info.de@wago.com](mailto:info.de@wago.com) | Web: [www.wago.com](http://www.wago.com)

Do you have any questions about our products?  
We are always happy to take your call at +49 (571) 887-44222.





doc - Datei

24.6 kB

## CAD/CAE-Data

### CAD data

2D/3D Models 770-245/064-000	<a href="#">URL</a>	<a href="#">Download</a>
------------------------------	---------------------	--------------------------

### CAE data

WSCAD Universe 770-245/064-000	<a href="#">URL</a>	<a href="#">Download</a>
--------------------------------	---------------------	--------------------------

WSCAD Universe 770-245/064-000	<a href="#">URL</a>	<a href="#">Download</a>
--------------------------------	---------------------	--------------------------

ZUKEN Portal 770-245/064-000	<a href="#">URL</a>	<a href="#">Download</a>
------------------------------	---------------------	--------------------------

## Environmental Product Compliance

### Compliance Search

Environmental Product Compliance 770-245/064-000	<a href="#">URL</a>	<a href="#">Download</a>
--	---------------------	--------------------------

Socket; 5-pole; Cod. B; 4,00 mm<sup>2</sup>; gray

## Installation Notes

### Conductor termination

Subject to changes. Please also observe the further product documentation!

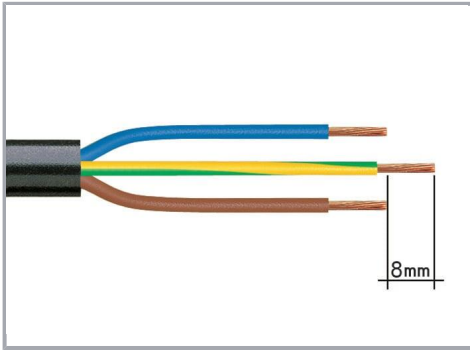

1. Strip length, outer insulation = 35 mm (2-pole), 55 mm (3- to 5-pole)

2. Strip length = 9 mm

3. Extended ground conductor = 8 mm

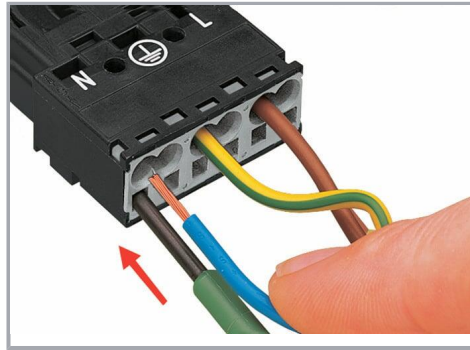

To terminate fine-stranded conductors, open the clamping unit via screwdriver (2.5 mm blade width) and insert a stripped conductor until it hits the backstop.

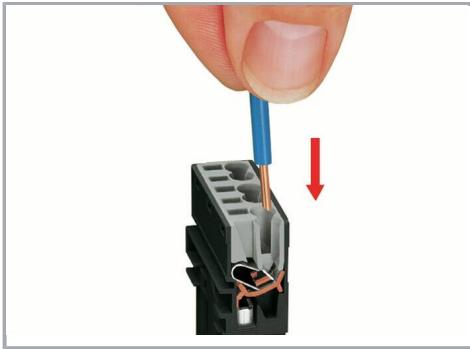

Insert the stripped solid conductor until it hits the backstop.

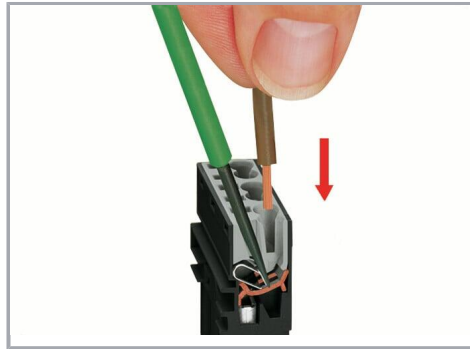

To terminate fine-stranded conductors, open the clamping unit via screwdriver (2.5 mm blade width) and insert a stripped conductor until it hits the backstop.

### Conductor removal

Subject to changes. Please also observe the further product documentation!

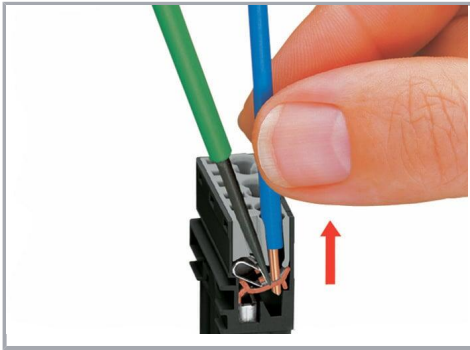

To remove the conductor, actuate the clamp via screwdriver (2.5 mm blade width) and pull out the conductor.

### Installation

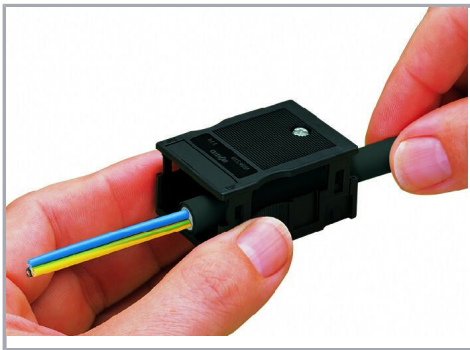

We recommend pulling the pre-latched strain relief housing over the cable prior to termination. However, the strain relief can be mounted at a later time as well.

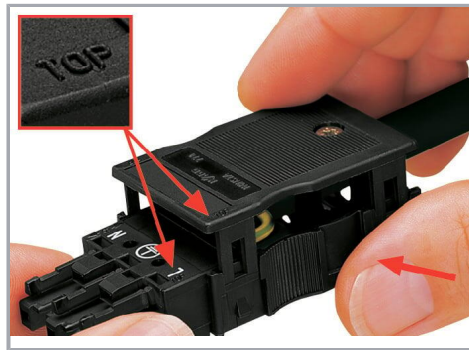

Latch the strain relief housing onto the plug /socket. Note the "TOP" inscription.

Subject to changes. Please also observe the further product documentation!

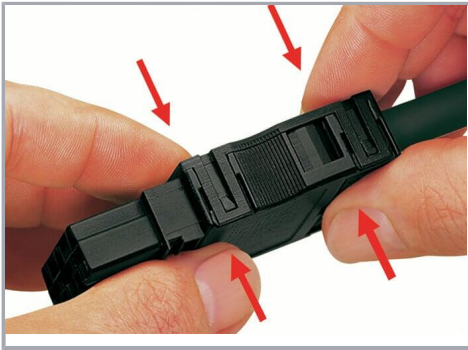

Prepare strain relief housing by snapping together upper and bottom part.



Tighten strain relief screw with screwdriver (2.5 mm blade width).

### Coding



Simply cut off the coding pin from the socket.

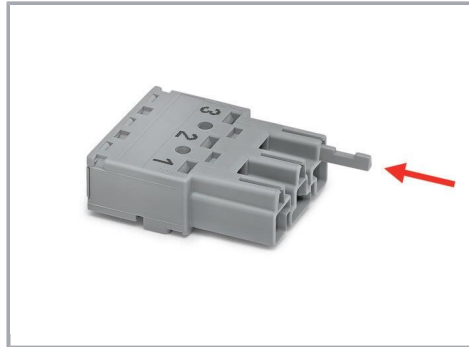

Insert coding pin into plug (break first) until it engages.

### Mismatching protection

Subject to changes. Please also observe the further product documentation!

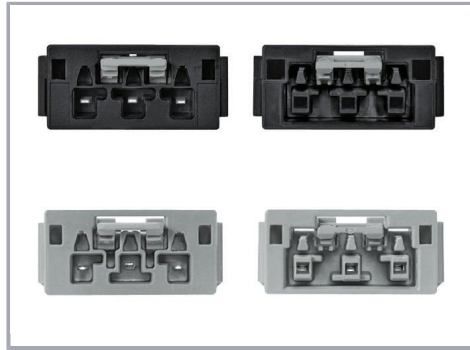
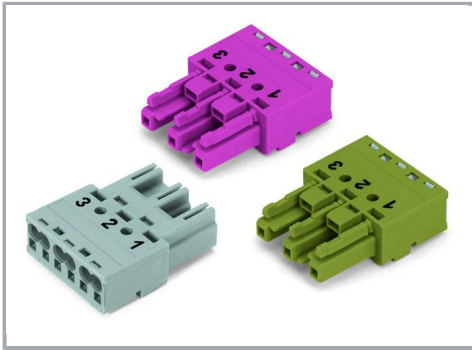

B-coded connectors with different colors can be plugged together.

Important note:

Different colors and/or pole markings are used for circuit identification.

Only connectors of the same color and same pole marking must be plugged together.

B-coded connectors (shown in gray) not only differ in color, but also in their design, making them incompatible with other coded connectors.



Easy circuit identification via different marking and colors

## Product family

**WINSTA® MIDI**

[Show all products from the family](#)

Subject to changes. Please also observe the further product documentation!