

AFE7906 6-Channel, 5-MHz to 12-GHz RF Sampling Receiver with 3-GSPS ADCs

1 Features

- [Request full data sheet](#)
- Six RF sampling 14 bit, 3 GSPS ADCs
- Maximum RF signal bandwidth:
 - 4 ADCs: 1200 MHz per ADC
 - 6 ADCs: 600 MHz per ADC
- RF frequency range: 5 MHz - 12 GHz
- Digital step attenuators (DSA): 25 dB range, 0.5-dB steps
- Single DDC (on 6 channels) or dual-band DDCs (on 4 channels)
- 16x NCOs per DDC channel
- Optional Internal PLL/VCO for ADC clocks or external clock at ADC sample rate
- Sysref alignment detector
- SerDes data interface:
 - JESD204B and JESD204C compatible
 - 8 SerDes transmitters up to 29.5 Gbps
 - Subclass 1 multi-device synchronization
- Package: 17-mm × 17-mm FCBGA, 0.8-mm pitch

2 Applications

- [Radar](#)
- [Seeker front end](#)
- [Defense radio](#)
- [Wireless communications test](#)

3 Description

The AFE7906 is a high performance, wide bandwidth multi-channel receiver, integrating six RF Sampling ADCs. With operation up to 12 GHz, this device enables direct RF sampling in the L, S, C and X-band frequency ranges without the need for additional frequency conversions stages. This improvement in density and flexibility enables high-channel-count, multi-mission systems.

Each receiver chain includes a 25-dB range DSA (Digital Step Attenuator), followed by a 3-GSPS ADC (analog-to-digital converter). Four receiver channels have an analog peak power detector and various digital power detectors to assist an external or internal autonomous automatic gain controller, and RF overload detectors for device reliability protection. Flexible decimation options provide optimization of data bandwidth up to 1200 MHz for four RX or 600 MHz.

The device contains a SYSREF timing detector to allow optimization of the SYSREF input timing relative to the device clock.

Package Information

PART NUMBER	PACKAGE ⁽¹⁾	PACKAGE SIZE ⁽²⁾
AFE7906	FC-BGA	17.00 mm × 17.00 mm

- (1) For all available packages, see the orderable addendum at the end of the data sheet.
- (2) The package size (length × width) is a nominal value and includes pins, where applicable.

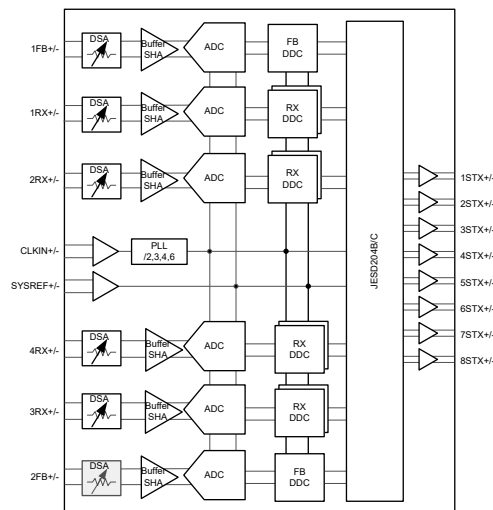

Functional Block Diagram



Table of Contents

1 Features	1	6.7 Digital Electrical Characteristics.....	14
2 Applications	1	6.8 Power Supply Electrical Characteristics.....	15
3 Description	1	6.9 Timing Requirements.....	17
4 Description (continued)	3	6.10 Switching Characteristics.....	18
5 Revision History	3	6.11 Typical Characteristics.....	19
6 Specifications	4	7 Device and Documentation Support	68
6.1 Absolute Maximum Ratings.....	4	7.1 Receiving Notification of Documentation Updates....	68
6.2 ESD Ratings.....	4	7.2 Support Resources.....	68
6.3 Recommended Operating Conditions.....	5	7.3 Trademarks.....	68
6.4 Thermal Information.....	5	7.4 Electrostatic Discharge Caution.....	68
6.5 RF ADC Electrical Characteristics.....	6	7.5 Glossary.....	68
6.6 PLL/VCO/Clock Electrical Characteristics.....	12	8 Mechanical, Packaging, and Orderable Information..	68

4 Description (continued)

Each receiver chain includes a 25-dB range DSA (Digital Step Attenuator), followed by a 3-GSPS ADC (analog-to-digital converter). Each receiver channel has an analog peak power detector and various digital power detectors to assist an external or internal autonomous automatic gain controller, and RF overload detectors for device reliability protection. Flexible decimation options provide optimization of data bandwidth up to 1200 MHz for four RX without FB paths or 600 MHz with two FB paths (1200 MHz BW each).

The device contains a SYSREF timing detector to allow optimization of the SYSREF input timing relative to the device clock.

5 Revision History

NOTE: Page numbers for previous revisions may differ from page numbers in the current version.

Changes from July 9, 2022 to May 30, 2023 (from Revision B (July 2022) to Revision C (May 2023))

	Page
• Changed the Device Information to <i>Package Information</i> table.....	1
• Changed I _{IH} and I _{IL} units to μA.....	14

Changes from March 11, 2022 to July 8, 2022 (from Revision A (March 2022) to Revision B (July 2022))

	Page
• Deleted ABJ from the Thermal Information table. The table applies to both ABJ and the ALK packages.....	4
• Changed 0RX - 3RX to 1RX - 4RX in several plots.....	40
• Changed 0RX - 3RX to 1RX - 4RX in several plots.....	45

Changes from Revision * (January 2022) to Revision A (March 2022)

	Page
• Added <i>Feature</i> to Request the full data sheet.....	1
• Added the Specification tables to the data sheet.....	4
• Changed Power Mode 4 to f _{RX} = 2.25 GHz.....	15
• Added the Typical Characteristics section to the data sheet.....	19

6 Specifications

6.1 Absolute Maximum Ratings

over operating free-air temperature range (unless otherwise noted)⁽¹⁾

		MIN	MAX	UNIT
Supply Voltage Range	DVDD0P9, VDDT0P9	-0.3	1.2	V
	VDD1P2RX, VDD1P2TXCLK, VDD1P2TXENC, VDD1P2PLL, VDD1P2PLLCLKREF, VDD1P2FB, VDD1P2FBCML, VDD1P2RXCML	-0.3	1.4	V
	VDD1P8RX, VDD1P8RXCLK, VDD1P8TX, VDD1P8TXDAC, VDD1P8TXENC, VDD1P8PLL, VDD1P8PLLVC0, VDD1P8FB, VDD1P8FBCML, VDD1P8GPIO, VDDA1P8	-0.5	2.1	V
Pin Voltage Range	{1/2/3/4}RXIN+/-	-0.5	VDDR1P8+0.3	V
	1FBIN+/-, 2FB+/-	-0.5	VDDFB1P8+0.3	V
	REFCLK+/-, SYSREF+/-	-0.3	1.4	V
	{1:8}STX+/-	-0.3	1.4	V
	GPIO{B/C/D/E}x, SPICLK, SPISDIO, SPISDO, SPISEN, RESETZ, BISTB0, BISTB1	-0.5	VDD1P8GPIO + 0.3	V
	IFORCE, VSENSE	-0.3	VDDCLK1P8 + 0.3	V
	SRDAMUX1, SRDAMUX2	-0.3	VDDA1P8+0.3	V
Peak Input Current	any input		20	mA
T _J	Junction temperature		150	°C
T _{stg}	Storage temperature	-65	150	°C

- (1) Stresses beyond those listed under *Absolute Maximum Ratings* may cause permanent damage to the device. These are stress ratings only, which do not imply functional operation of the device at these or any other conditions beyond those indicated under [Recommended Operating Conditions](#). Exposure to absolute-maximum-rated conditions for extended periods may affect device reliability.

6.2 ESD Ratings

			VALUE	UNIT
V _(ESD)	Electrostatic discharge	Human body model (HBM), per ANSI/ESDA/ JEDEC JS-001, all pins ⁽¹⁾	1000	V
		Charged device model (CDM), per ANSI/ESDA/ JEDEC JS-002, all pins ⁽²⁾	150	

- (1) JEDEC document JEP155 states that 500-V HBM allows safe manufacturing with a standard ESD control process.
 (2) JEDEC document JEP157 states that 250-V CDM allows safe manufacturing with a standard ESD control process. Manufacturing with less than 250-V CDM is possible if necessary precautions are taken.

6.3 Recommended Operating Conditions

over operating free-air temperature range (unless otherwise noted)

		MIN	NOM	MAX	UNIT
DVDD0P9, VDDT0P9	Supply voltage 0.9V	0.9	0.925	0.95	V
VDD1P2{RX/TXCLK/TXENC/FB/PLL/PLLCLKREF/FBCML/RXCML}	Supply voltage 1.2V	1.15	1.2	1.25	V
VDD1P8{RX/RXCLK/TX/TXDAC/TXENC/PLL/PLLVCO/FB/FBCLK/GPIO}, VDDA1P8	Supply voltage 1.8V	1.75	1.8	1.85	V
T _A	Ambient temperature	-40		85	°C
T _J	Operating Junction Temperature			110 ⁽¹⁾	°C
	Maximum Operating Junction Temperature	125			°C

- (1) Prolonged use at or above this junction temperature can increase the device failure-in-time (FIT) rate. Refer to [SBAA403 application note](#) for additional details

6.4 Thermal Information

THERMAL METRIC ⁽¹⁾		AFE7906	UNIT
		FC-BGA	
		400 PINS	
R _{θJA}	Junction-to-ambient thermal resistance	16.2	°C/W
R _{θJC(top)}	Junction-to-case (top) thermal resistance	0.42	°C/W
R _{θJB}	Junction-to-board thermal resistance	4.85	°C/W
Ψ _{JT}	Junction-to-top characterization parameter	0.12	°C/W
Ψ _{JB}	Junction-to-board characterization parameter	4.6	°C/W

- (1) For more information about traditional and new thermal metrics, see the [Semiconductor and IC Package Thermal Metrics](#) application report.

6.5 RF ADC Electrical Characteristics

Typical values at $T_A = +25^\circ\text{C}$, full temperature range is $T_{A,\text{MIN}} = -40^\circ\text{C}$ to $T_{J,\text{MAX}} = +110^\circ\text{C}$; RX Output Rate = 491.52MSPS below 6GHz input frequency and 1500MSPS above 6GHz input frequency, $f_{\text{ADC}} = 2949.12\text{MSPS}$; PLL clock mode with $f_{\text{REF}} = 491.52\text{MHz}$ below 6GHz input frequency and External clock mode with $f_{\text{CLK}} = 2949.12\text{MHz}$ above 6GHz input frequency; nominal power supplies; DSA Setting =3dB; SerDes rate =24.33Gbps; unless otherwise noted.

PARAMETER		TEST CONDITIONS	MIN	TYP	MAX	UNIT
ADC _{RES}	ADC resolution			14		bits
F _{RFin}	RF input frequency range		5		12000	MHz
P _{FS_CW,min}	Min Full scale input power, at device pins ⁽¹⁾	$f_{\text{IN}} = 5 \text{ MHz}$, DSA=0dB, $f_{\text{ADC}} = 1500\text{MSPS}$, $f_{\text{NCO}} = 17\text{MHz}$, Decimate by 48		-0.4		dBm
		$f_{\text{IN}} = 30 \text{ MHz}$, DSA=0dB, $f_{\text{ADC}} = 1500\text{MSPS}$, $f_{\text{NCO}} = 30\text{MHz}$, Decimate by 24		-2.2		
		$f_{\text{IN}} = 410 \text{ MHz}$, DSA=0dB, $f_{\text{ADC}} = 3000\text{MSPS}$, $f_{\text{NCO}} = 400\text{MHz}$, Decimate by 12		-2.5		
		$f_{\text{IN}} = 830 \text{ MHz}$, DSA=0dB		-2.9		
		$f_{\text{IN}} = 1760 \text{ MHz}$, DSA=0dB		-2.8		
		$f_{\text{IN}} = 2610 \text{ MHz}$, DSA=0dB		-1.8		
		$f_{\text{IN}} = 3610 \text{ MHz}$, DSA=0dB		-0.4		
		$f_{\text{IN}} = 4910 \text{ MHz}$, DSA=0dB		0.1		
		$f_{\text{IN}} = 8150 \text{ MHz}$, DSA=0dB		2.1		
		$f_{\text{IN}} = 9610 \text{ MHz}$, DSA=0dB		4.3		
P _{FS_CW,MAX}	MAX Full scale input power - reliability limited, at device pins	$f_{\text{IN}} = 5 \text{ MHz}$, $f_{\text{ADC}} = 1500\text{MSPS}$, $f_{\text{NCO}} = 17\text{MHz}$, Decimate by 48		19.7		dBm
		$f_{\text{IN}} = 30 \text{ MHz}$, $f_{\text{ADC}} = 1500\text{MSPS}$, $f_{\text{NCO}} = 30\text{MHz}$, Decimate by 24		17.8		
		$f_{\text{IN}} = 410 \text{ MHz}$, $f_{\text{ADC}} = 3000\text{MSPS}$, $f_{\text{NCO}} = 400\text{MHz}$, Decimate by 24		17.6		
		$f_{\text{IN}} = 830 \text{ MHz}$		16.7		
		$f_{\text{IN}} = 1760 \text{ MHz}$		17.0		
		$f_{\text{IN}} = 2610 \text{ MHz}$		18		
		$f_{\text{IN}} = 3610 \text{ MHz}$		18.5		
		$f_{\text{IN}} = 4910 \text{ MHz}$		19.3		
		$f_{\text{IN}} = 8150 \text{ MHz}$		21.3		
		$f_{\text{IN}} = 9610 \text{ MHz}$		23.5		
R _{TERM}	Input reference impedance			100.0		Ω
ATT _{range}	DSA Attenuation range			25.0		dB
ATT _{step}	DSA Attenuation step			0.5		dB
	DSA Attenuation step accuracy	Delta=Gatt(X)-Gatt(X-1), $F_{\text{in}}=3610\text{MHz}$, after calibration		0.1		
	DSA Gain Steps Phase accuracy any 8dB range	$F_{\text{in}}=3610\text{MHz}$, after calibration		0.9		deg
	DSA Gain Steps Phase accuracy any 8dB range	$F_{\text{in}}=4910\text{MHz}$, after calibration		1.8		
G _{flat}	Gain flatness	Measured Over 80MHz BW		0.2		dB
		Measured Over 200MHz BW		0.5		
		Measured Over 400MHz BW		1.1		

6.5 RF ADC Electrical Characteristics (continued)

Typical values at $T_A = +25^\circ\text{C}$, full temperature range is $T_{A,\text{MIN}} = -40^\circ\text{C}$ to $T_{J,\text{MAX}} = +110^\circ\text{C}$; RX Output Rate = 491.52MSPS below 6GHz input frequency and 1500MSPS above 6GHz input frequency, $f_{\text{ADC}} = 2949.12\text{MSPS}$; PLL clock mode with $f_{\text{REF}} = 491.52\text{MHz}$ below 6GHz input frequency and External clock mode with $f_{\text{CLK}} = 2949.12\text{MHz}$ above 6GHz input frequency; nominal power supplies; DSA Setting =3dB; SerDes rate =24.33Gbps; unless otherwise noted.

PARAMETER		TEST CONDITIONS	MIN	TYP	MAX	UNIT
NSD	Noise Density (small signal = -30dBFS)	$f_{\text{IN}} = 5\text{ MHz}$, DSA = 3dB, $f_{\text{ADC}} = 1500\text{MSPS}$, $f_{\text{NCO}} = 17\text{MHz}$, Decimate by 48		-147.1		dBFS/Hz
		$f_{\text{IN}} = 30\text{ MHz}$, DSA = 3dB, $f_{\text{ADC}} = 1500\text{MSPS}$, $f_{\text{NCO}} = 30\text{MHz}$, Decimate by 24		-150.7		
		$f_{\text{IN}} = 410\text{ MHz}$, DSA = 3dB, $f_{\text{ADC}} = 3000\text{MSPS}$, $f_{\text{NCO}} = 400\text{MHz}$, Decimate by 24		-155.4		
		$f_{\text{IN}} = 830\text{ MHz}$, DSA = 3dB ⁽³⁾		-156.2		
		$f_{\text{IN}} = 1760\text{ MHz}$, DSA = 3dB ⁽³⁾		-156.0		
		$f_{\text{IN}} = 2610\text{ MHz}$, DSA = 3dB ⁽³⁾		-155.4		
		$f_{\text{IN}} = 3610\text{ MHz}$, DSA = 3dB ⁽³⁾		-155.1		
		$f_{\text{IN}} = 4910\text{ MHz}$, DSA = 3dB ⁽³⁾		-155.1		
		$f_{\text{IN}} = 8110\text{ MHz}$, DSA = 3dB ⁽³⁾		-152		
		$f_{\text{IN}} = 9610\text{ MHz}$, DSA = 3dB ⁽³⁾		-151		
		$f_{\text{IN}} = 5\text{ MHz}$, $f_{\text{ADC}} = 1500\text{MSPS}$, $f_{\text{NCO}} = 17\text{MHz}$, Decimate by 48, 3<=Atten<=22		-147.8		
		$f_{\text{IN}} = 30\text{ MHz}$, $f_{\text{ADC}} = 1500\text{MSPS}$, $f_{\text{NCO}} = 30\text{MHz}$, Decimate by 24, 3<=Atten<=22		-151.5		
		$f_{\text{IN}} = 410\text{ MHz}$, 3<=Atten<=22, $f_{\text{ADC}} = 3000\text{MSPS}$, $f_{\text{NCO}} = 400\text{MHz}$, Decimate by 24		-156.6		
		$f_{\text{IN}} = 830\text{ MHz}$, 3<=Atten<=22		-156.0		
		$f_{\text{IN}} = 1760\text{ MHz}$, 3<=Atten<=25		-155.8		
		$f_{\text{IN}} = 2610\text{ MHz}$, 3<=Atten<=25		-155.7		
		$f_{\text{IN}} = 3610\text{ MHz}$, 3<=Atten<=25		-155.4		
		$f_{\text{IN}} = 4910\text{ MHz}$, 3<=Atten<=25		-155.8		
		$f_{\text{IN}} = 8150\text{ MHz}$, 3<=Atten<=25		-152.5		
		$f_{\text{IN}} = 9610\text{ MHz}$, 3<=Atten<=25		-152.5		
NF _{min}	Noise Figure min DSA Atten=0 - 3dB	$f_{\text{IN}} = 5\text{ MHz}$, $f_{\text{ADC}} = 1500\text{MSPS}$, $f_{\text{NCO}} = 17\text{MHz}$, Decimate by 48		29.4		dB
		$f_{\text{IN}} = 30\text{ MHz}$, $f_{\text{ADC}} = 1500\text{MSPS}$, $f_{\text{NCO}} = 30\text{MHz}$, Decimate by 24		24.5		
		$f_{\text{IN}} = 410\text{ MHz}$, $f_{\text{ADC}} = 3000\text{MSPS}$, $f_{\text{NCO}} = 400\text{MHz}$, Decimate by 24		19.3		
		$f_{\text{IN}} = 830\text{ MHz}$		19.1		
		$f_{\text{IN}} = 1760\text{ MHz}$		19.0		
		$f_{\text{IN}} = 2610\text{ MHz}$		20.9		
		$f_{\text{IN}} = 3610\text{ MHz}$		22.8		
		$f_{\text{IN}} = 4910\text{ MHz}$		22.4		
		$f_{\text{IN}} = 8150\text{ MHz}$		27.3		
$f_{\text{IN}} = 9610\text{ MHz}$		30				

6.5 RF ADC Electrical Characteristics (continued)

Typical values at $T_A = +25^\circ\text{C}$, full temperature range is $T_{A,\text{MIN}} = -40^\circ\text{C}$ to $T_{J,\text{MAX}} = +110^\circ\text{C}$; RX Output Rate = 491.52MSPS below 6GHz input frequency and 1500MSPS above 6GHz input frequency, $f_{\text{ADC}} = 2949.12\text{MSPS}$; PLL clock mode with $f_{\text{REF}} = 491.52\text{MHz}$ below 6GHz input frequency and External clock mode with $f_{\text{CLK}} = 2949.12\text{MHz}$ above 6GHz input frequency; nominal power supplies; DSA Setting =3dB; SerDes rate =24.33Gbps; unless otherwise noted.

PARAMETER		TEST CONDITIONS	MIN	TYP	MAX	UNIT
NF	Noise Figure ⁽⁴⁾ DSA Atten=4dB	$f_{\text{IN}} = 5\text{ MHz}$, $f_{\text{ADC}} = 1500\text{MSPS}$, $f_{\text{NCO}} = 17\text{MHz}$, Decimate by 48		30.6		dB
		$f_{\text{IN}} = 30\text{ MHz}$, $f_{\text{ADC}} = 1500\text{MSPS}$, $f_{\text{NCO}} = 30\text{MHz}$, Decimate by 24		25.1		
		$f_{\text{IN}} = 410\text{ MHz}$, $f_{\text{ADC}} = 3000\text{MSPS}$, $f_{\text{NCO}} = 400\text{MHz}$, Decimate by 24		20.1		
		$f_{\text{IN}} = 830\text{ MHz}$		20.0		
		$f_{\text{IN}} = 1760\text{ MHz}$		20.6		
		$f_{\text{IN}} = 2610\text{ MHz}$		21.9		
		$f_{\text{IN}} = 3610\text{ MHz}$		23.5		
		$f_{\text{IN}} = 4910\text{ MHz}$		22.3		
		$f_{\text{IN}} = 8150\text{ MHz}$		27.9		
		$f_{\text{IN}} = 9610\text{ MHz}$		30.7		
NF _{max}	Noise Figure ⁽⁴⁾ DSA Atten=20dB	$f_{\text{IN}} = 5\text{ MHz}$, $f_{\text{ADC}} = 1500\text{MSPS}$, $f_{\text{NCO}} = 17\text{MHz}$, Decimate by 48		45.9		dB
		$f_{\text{IN}} = 30\text{ MHz}$, $f_{\text{ADC}} = 1500\text{MSPS}$, $f_{\text{NCO}} = 30\text{MHz}$, Decimate by 24		40.2		
		$f_{\text{IN}} = 410\text{ MHz}$, $f_{\text{ADC}} = 3000\text{MSPS}$, $f_{\text{NCO}} = 400\text{MHz}$, Decimate by 24		35.0		
		$f_{\text{IN}} = 830\text{ MHz}$		34.7		
		$f_{\text{IN}} = 1760\text{ MHz}$		35.2		
		$f_{\text{IN}} = 2610\text{ MHz}$		36.0		
		$f_{\text{IN}} = 3610\text{ MHz}$		37.3		
		$f_{\text{IN}} = 4910\text{ MHz}$		37.6		
		$f_{\text{IN}} = 8150\text{ MHz}$		42.8		
		$f_{\text{IN}} = 9610\text{ MHz}$		45		
IMD3	3 rd order intermodulation 2 tones at $f_{\text{IN}} \pm 10\text{MHz}$ -7dBFS each tone	$f_{\text{IN}} = 30 \pm 1\text{ MHz}$, $f_{\text{ADC}} = 1500\text{MSPS}$, $f_{\text{NCO}} = 30\text{MHz}$, Decimate by 24		-82		dBc
		$f_{\text{IN}} = 400\text{MHz}$ and 405MHz , $f_{\text{ADC}} = 3000\text{MSPS}$, $f_{\text{NCO}} = 400\text{MHz}$, Decimate by 24		-75		
		$f_{\text{IN}} = 840\text{ MHz}$, $3 \leq \text{Atten} \leq 12$		-82		
		$f_{\text{IN}} = 1770\text{ MHz}$, $3 \leq \text{Atten} \leq 12$		-84		
		$f_{\text{IN}} = 2610\text{ MHz}$, $3 \leq \text{Atten} \leq 12$		-74		
		$f_{\text{IN}} = 3610\text{ MHz}$, $3 \leq \text{Atten} \leq 12$		-77		
		$f_{\text{IN}} = 4920\text{ MHz}$, $3 \leq \text{Atten} \leq 12$		-76		
		$f_{\text{IN}} = 8150\text{ MHz}$, $3 \leq \text{Atten} \leq 12$, 25MHz tone spacing		-59		
$f_{\text{IN}} = 9610\text{ MHz}$, $3 \leq \text{Atten} \leq 12$, 25MHz tone spacing		-60				

6.5 RF ADC Electrical Characteristics (continued)

Typical values at $T_A = +25^\circ\text{C}$, full temperature range is $T_{A,\text{MIN}} = -40^\circ\text{C}$ to $T_{J,\text{MAX}} = +110^\circ\text{C}$; RX Output Rate = 491.52MSPS below 6GHz input frequency and 1500MSPS above 6GHz input frequency, $f_{\text{ADC}} = 2949.12\text{MSPS}$; PLL clock mode with $f_{\text{REF}} = 491.52\text{MHz}$ below 6GHz input frequency and External clock mode with $f_{\text{CLK}} = 2949.12\text{MHz}$ above 6GHz input frequency; nominal power supplies; DSA Setting =3dB; SerDes rate =24.33Gbps; unless otherwise noted.

PARAMETER		TEST CONDITIONS	MIN	TYP	MAX	UNIT
SFDR	Spurious Free Dynamic Range within output bandwidth, $A_{\text{IN}} = -3$ dBFS	$f_{\text{IN}} = 5$ MHz, $f_{\text{ADC}} = 1500\text{MSPS}$, $f_{\text{NCO}} = 17\text{MHz}$, Decimate by 48		78		dBFS
		$f_{\text{IN}} = 30$ MHz, $f_{\text{ADC}} = 1500\text{MSPS}$, $f_{\text{NCO}} = 30\text{MHz}$, Decimate by 24		100		
		$f_{\text{IN}} = 410$ MHz, $f_{\text{ADC}} = 3000\text{MSPS}$, $f_{\text{NCO}} = 400\text{MHz}$, Decimate by 24		94		
		$f_{\text{IN}} = 830$ MHz		88		
		$f_{\text{IN}} = 1760$ MHz		81		
		$f_{\text{IN}} = 2610$ MHz		88		
		$f_{\text{IN}} = 3610$ MHz		84		
		$f_{\text{IN}} = 4910$ MHz		79		
		$f_{\text{IN}} = 8150$ MHz		78		
HD2	2nd Harmonic Distortion $A_{\text{IN}} = -3$ dBFS ⁽²⁾	$f_{\text{IN}} = 5$ MHz, $f_{\text{ADC}} = 1500\text{MSPS}$, $f_{\text{NCO}} = 17\text{MHz}$, Decimate by 48		-84		dBFS
		$f_{\text{IN}} = 30$ MHz, $f_{\text{ADC}} = 1500\text{MSPS}$, Bypass Mode (TI only test mode)		-91		
		$f_{\text{IN}} = 410$ MHz, $f_{\text{ADC}} = 3000\text{MSPS}$, Bypass Mode (TI only test mode)		-90		
		$f_{\text{IN}} = 830$ MHz		-86		
		$f_{\text{IN}} = 1760$ MHz		-90		
		$f_{\text{IN}} = 2610$ MHz		-88		
		$f_{\text{IN}} = 3610$ MHz		-87		
		$f_{\text{IN}} = 4910$ MHz		-84		
		$f_{\text{IN}} = 8150$ MHz		-70		
HD3	3rd Harmonic Distortion $A_{\text{IN}} = -3$ dBFS	$f_{\text{IN}} = 5$ MHz, $f_{\text{ADC}} = 1500\text{MSPS}$, $f_{\text{NCO}} = 17\text{MHz}$, Decimate by 48		-78		dBFS
		$f_{\text{IN}} = 30$ MHz, $f_{\text{ADC}} = 1500\text{MSPS}$, Bypass Mode (TI only test mode)		-96		
		$f_{\text{IN}} = 410$ MHz, $f_{\text{ADC}} = 3000\text{MSPS}$, Bypass Mode (TI only test mode)		-94		
		$f_{\text{IN}} = 830$ MHz		-80		
		$f_{\text{IN}} = 1760$ MHz		-85		
		$f_{\text{IN}} = 2610$ MHz		-86		
		$f_{\text{IN}} = 3610$ MHz		-78		
		$f_{\text{IN}} = 4910$ MHz		-75		
		$f_{\text{IN}} = 8150$ MHz		-70		
$f_{\text{IN}} = 9610$ MHz		-70				

6.5 RF ADC Electrical Characteristics (continued)

Typical values at $T_A = +25^\circ\text{C}$, full temperature range is $T_{A,\text{MIN}} = -40^\circ\text{C}$ to $T_{J,\text{MAX}} = +110^\circ\text{C}$; RX Output Rate = 491.52MSPS below 6GHz input frequency and 1500MSPS above 6GHz input frequency, $f_{\text{ADC}} = 2949.12\text{MSPS}$; PLL clock mode with $f_{\text{REF}} = 491.52\text{MHz}$ below 6GHz input frequency and External clock mode with $f_{\text{CLK}} = 2949.12\text{MHz}$ above 6GHz input frequency; nominal power supplies; DSA Setting =3dB; SerDes rate =24.33Gbps; unless otherwise noted.

PARAMETER		TEST CONDITIONS	MIN	TYP	MAX	UNIT
HDn, n>3	SFDR excl. HD2 and HD3 $A_{\text{IN}} = -3 \text{ dBFS}$	$f_{\text{IN}} = 5 \text{ MHz}$, $f_{\text{ADC}} = 1500\text{MSPS}$, $f_{\text{NCO}} = 17\text{MHz}$, Decimate by 48		-94		dBFS
		$f_{\text{IN}} = 30 \text{ MHz}$, $f_{\text{ADC}} = 1500\text{MSPS}$, $f_{\text{NCO}} = 30\text{MHz}$, Decimate by 24		-94		
		$f_{\text{IN}} = 410 \text{ MHz}$, $f_{\text{ADC}} = 3000\text{MSPS}$, $f_{\text{NCO}} = 400\text{MHz}$, Decimate by 24		-94		
		$f_{\text{IN}} = 830 \text{ MHz}$		-88		
		$f_{\text{IN}} = 1760 \text{ MHz}$		-81		
		$f_{\text{IN}} = 2610 \text{ MHz}$		-88		
		$f_{\text{IN}} = 3610 \text{ MHz}$		-84		
		$f_{\text{IN}} = 4910 \text{ MHz}$		-82		
		$f_{\text{IN}} = 8150 \text{ MHz}$		-78		
SFDR	Spurious Free Dynamic Range $A_{\text{IN}} = -13 \text{ dBFS}$	$f_{\text{IN}} = 5 \text{ MHz}$, $f_{\text{ADC}} = 1500\text{MSPS}$, $f_{\text{NCO}} = 17\text{MHz}$, Decimate by 48		101		dBFS
		$f_{\text{IN}} = 30 \text{ MHz}$, $f_{\text{ADC}} = 1500\text{MSPS}$, $f_{\text{NCO}} = 30\text{MHz}$, Decimate by 24		105		
		$f_{\text{IN}} = 410 \text{ MHz}$, $f_{\text{ADC}} = 3000\text{MSPS}$, $f_{\text{NCO}} = 400\text{MHz}$, Decimate by 24		95		
		$f_{\text{IN}} = 830 \text{ MHz}$		89		
		$f_{\text{IN}} = 1760 \text{ MHz}$		89		
		$f_{\text{IN}} = 2610 \text{ MHz}$		95		
		$f_{\text{IN}} = 3610 \text{ MHz}$		87		
		$f_{\text{IN}} = 4910 \text{ MHz}$		90		
		$f_{\text{IN}} = 8150 \text{ MHz}$		83		
HD2	2nd Harmonic Distortion ⁽²⁾ $A_{\text{IN}} = -13 \text{ dBFS}$	$f_{\text{IN}} = 5 \text{ MHz}$, $f_{\text{ADC}} = 1500\text{MSPS}$, $f_{\text{NCO}} = 17\text{MHz}$, Decimate by 48		-104		dBFS
		$f_{\text{IN}} = 30 \text{ MHz}$, $f_{\text{ADC}} = 1500\text{MSPS}$, Bypass Mode (TI only test mode)		-91		
		$f_{\text{IN}} = 410 \text{ MHz}$, $f_{\text{ADC}} = 3000\text{MSPS}$, Bypass Mode (TI only test mode)		-104		
		$f_{\text{IN}} = 830 \text{ MHz}$, with board trim		-79		
		$f_{\text{IN}} = 1760 \text{ MHz}$, with board trim		-102		
		$f_{\text{IN}} = 2610 \text{ MHz}$, with board trim		-100		
		$f_{\text{IN}} = 3610 \text{ MHz}$, with board trim		-101		
		$f_{\text{IN}} = 4910 \text{ MHz}$, with board trim		-99		
		$f_{\text{IN}} = 8150 \text{ MHz}$, with board trim		-107		
$f_{\text{IN}} = 9610 \text{ MHz}$, with board trim		-107				

6.5 RF ADC Electrical Characteristics (continued)

Typical values at $T_A = +25^\circ\text{C}$, full temperature range is $T_{A,\text{MIN}} = -40^\circ\text{C}$ to $T_{J,\text{MAX}} = +110^\circ\text{C}$; RX Output Rate = 491.52MSPS below 6GHz input frequency and 1500MSPS above 6GHz input frequency, $f_{\text{ADC}} = 2949.12\text{MSPS}$; PLL clock mode with $f_{\text{REF}} = 491.52\text{MHz}$ below 6GHz input frequency and External clock mode with $f_{\text{CLK}} = 2949.12\text{MHz}$ above 6GHz input frequency; nominal power supplies; DSA Setting =3dB; SerDes rate =24.33Gbps; unless otherwise noted.

PARAMETER		TEST CONDITIONS	MIN	TYP	MAX	UNIT
HD3	3rd Harmonic Distortion $A_{\text{IN}} = -13 \text{ dBFS}$	$f_{\text{IN}} = 5 \text{ MHz}$, $f_{\text{ADC}} = 1500\text{MSPS}$, $f_{\text{NCO}} = 17\text{MHz}$, Decimate by 48		-103		dBFS
		$f_{\text{IN}} = 30 \text{ MHz}$, $f_{\text{ADC}} = 1500\text{MSPS}$, Bypass Mode (TI only test mode)		-84		
		$f_{\text{IN}} = 381 \text{ MHz}$, $f_{\text{ADC}} = 3000\text{MSPS}$, Bypass Mode (TI only test mode)		-91		
		$f_{\text{IN}} = 830 \text{ MHz}$		-95		
		$f_{\text{IN}} = 1760 \text{ MHz}$		-95		
		$f_{\text{IN}} = 2610 \text{ MHz}$		-98		
		$f_{\text{IN}} = 3610 \text{ MHz}$		-97		
		$f_{\text{IN}} = 4910 \text{ MHz}$		-94		
		$f_{\text{IN}} = 8150 \text{ MHz}$		-100		
		$f_{\text{IN}} = 9610 \text{ MHz}$		-102		
HDn, n>3	SFDR excl. HD2 and HD3 $A_{\text{IN}} = -13 \text{ dBFS}$	$f_{\text{IN}} = 5 \text{ MHz}$, $f_{\text{ADC}} = 1500\text{MSPS}$, $f_{\text{NCO}} = 17\text{MHz}$, Decimate by 48		-104		dBFS
		$f_{\text{IN}} = 30 \text{ MHz}$, $f_{\text{ADC}} = 1500\text{MSPS}$, $f_{\text{NCO}} = 30\text{MHz}$, Decimate by 24		-105		
		$f_{\text{IN}} = 410 \text{ MHz}$, $f_{\text{ADC}} = 3000\text{MSPS}$, $f_{\text{NCO}} = 400\text{MHz}$, Decimate by 24		-95		
		$f_{\text{IN}} = 830 \text{ MHz}$		-89		
		$f_{\text{IN}} = 1760 \text{ MHz}$		-89		
		$f_{\text{IN}} = 2610 \text{ MHz}$		-95		
		$f_{\text{IN}} = 3610 \text{ MHz}$		-90		
		$f_{\text{IN}} = 4910 \text{ MHz}$		-90		
RX-RX/FB Isolation	Near Channel: 1RXIN to 2RXIN 3RXIN to 4RXIN 1FBIN to 1RXIN 2FBIN to 3RXIN	$f_{\text{IN}} = 5 \text{ MHz}$, $f_{\text{ADC}} = 1500\text{MSPS}$, $f_{\text{NCO}} = 17\text{MHz}$, Decimate by 48		-98		dB
		$f_{\text{IN}} = 30 \text{ MHz}$, $f_{\text{ADC}} = 1500\text{MSPS}$, $f_{\text{NCO}} = 30\text{MHz}$, Decimate by 24		-98		
		$f_{\text{IN}} = 400 \text{ MHz}$		-88		
		$f_{\text{IN}} = 830 \text{ MHz}$		-77		
		$f_{\text{IN}} = 1760 \text{ MHz}$		-71		
		$f_{\text{IN}} = 2610 \text{ MHz}$		-74		
		$f_{\text{IN}} = 3610 \text{ MHz}$		-77		
		$f_{\text{IN}} = 4910 \text{ MHz}$		-65		
		$f_{\text{IN}} = 8150 \text{ MHz}$		-68		
$f_{\text{IN}} = 9610 \text{ MHz}$		-68				

- (1) The input fullscale at minimum attenuation can be reduce by adding a digital gain range to the DSA, extending the useful range of the DSA. The noise figure remains constant over the digital gain range.
- (2) After HD2 trim on specific printed circuit board.
- (3) From DSA = 3dB down to 0dB, NSD increases 1dB per DSA dB
- (4) NF increase 1dB per DSA 1dB above DSA = 3dB

6.6 PLL/VCO/Clock Electrical Characteristics

Typical values at TA = +25°C, full temperature range is T_{A,MIN} = -40°C to T_{J,MAX} = +110°C; Reference clock input frequency 491.52MHz (unless otherwise noted), phase noise normalized to f_{VCO}.

PARAMETER		TEST CONDITIONS	MIN	TYP	MAX	UNIT
f _{VCO1}	VCO1 min frequency				7.2	GHz
	VCO1 max frequency		7.68			GHz
f _{VCO2}	VCO2 min frequency				8.848	GHz
	VCO2 max frequency		9.216			GHz
f _{VCO3}	VCO3 min frequency				9.8304	GHz
	VCO3 max frequency		10.24			GHz
f _{VCO4}	VCO4 min frequency				11.7965	GHz
	VCO4 max frequency		12.288			GHz
DIV _{FBADC}	ADC sample rate divider from VCO rate			1, 2, 3, 4, 6 or 8		
DIV _{RXADC}	ADC sample rate divider			1, 2, 3, 4, 6 or 8		
PN _{VCO}	Closed Loop Phase Noise F _{PLL} = 11.79848 GHz F _{REF} =491.52MHz	600kHz		-113		dBc/Hz
		800kHz		-116		dBc/Hz
		1MHz		-119		dBc/Hz
		1.8MHz		-125		dBc/Hz
		5MHz		-133		dBc/Hz
		50MHz		-141		dBc/Hz
	Closed Loop Phase Noise F _{PLL} =8.84736 GHz F _{REF} =491.52MHz	600kHz		-114		dBc/Hz
		800kHz		-118		dBc/Hz
		1MHz		-120		dBc/Hz
		1.8MHz		-127		dBc/Hz
		5MHz		-135		dBc/Hz
		50MHz		-142		dBc/Hz
	Closed Loop Phase Noise F _{PLL} = 9.8403 GHz F _{REF} =491.52MHz	600kHz		-113		dBc/Hz
		800kHz		-116		dBc/Hz
		1MHz		-119		dBc/Hz
		1.8MHz		-125		dBc/Hz
		5MHz		-134		dBc/Hz
		50MHz		-140		dBc/Hz
	Closed Loop Phase Noise F _{PLL} = 7.86432GHz F _{REF} =491.52MHz	600kHz		-116		dBc/Hz
		800kHz		-119		dBc/Hz
		1MHz		-122		dBc/Hz
		1.8MHz		-127		dBc/Hz
		5MHz		-136		dBc/Hz
		50MHz		-143		dBc/Hz
F _{rms}	Clock PLL integrated phase error ⁽¹⁾	f _{PLL} =11.79848 GHz, [1KHz, 100MHz]		-43.4		dBc/Hz
		f _{PLL} =8.8536 GHz, [1KHz, 100MHz]		-47.6		dBc/Hz
		f _{PLL} =9.8304 GHz, [1KHz, 100MHz]		-46.2		dBc/Hz
f _{PFD}	PFD frequency		100		500	MHz
PN _{pll_flat}	Normalized PLL flat Noise	f _{VCO} = 11796.48MHz		-226.5		dBc/Hz
F _{REF}	Input Clock frequency		0.1		12	GHz
V _{SS}	Input Clock level		0.6		1.8	Vppdiff

6.6 PLL/VCO/Clock Electrical Characteristics (continued)

Typical values at $T_A = +25^\circ\text{C}$, full temperature range is $T_{A,\text{MIN}} = -40^\circ\text{C}$ to $T_{J,\text{MAX}} = +110^\circ\text{C}$; Reference clock input frequency 491.52MHz (unless otherwise noted), phase noise normalized to f_{VCO} .

PARAMETER		TEST CONDITIONS	MIN	TYP	MAX	UNIT
Coupling				AC Coupling Only		
	REFCLK input impedance ⁽²⁾	Parallel resistance		100		Ω
		Parallel capacitance		0.5		pF

- (1) Single Sideband, not including the reference clock contribution
 (2) Refer to S11 data available from TI for impedance vs frequency

6.7 Digital Electrical Characteristics

Typical values at TA = +25°C, full temperature range is T_{A,MIN} = -40°C to T_{J,MAX} = +110°C (unless otherwise noted)

PARAMETER		TEST CONDITIONS	MIN	TYP	MAX	UNIT
CML SerDes Outputs [8:1]STX+/-						
F _{SerDes}	SerDes Bit Rate	Full rate mode	19		29.5	Gbps
		Half rate mode	9.5		16.25	
		Quarter rate mode	4.75		8.125	
		1/8 th rate mode	2.375		4.062	
		1/16 th rate mode	1.1875		2.031	
T _J	Total Jitter Tolerance				0.42	UI
V _{STDIFF}	SerDes Transmitter Output Amplitude	differential	500		1000	mVpp
V _{STCOM}	SerDes Output Common Mode		0.4	0.45	0.55	V
Z _{STdiff}	SerDes Output Impedance			100		Ω
TRF	Output rise and fall time	20-80%	8			ps
TTJ	Output total jitter				0.21	UI
CMOS I/O: GPIO{B/C/D/E}x, SPICLK, SPISDIO, SPISDO, SPISEN, RESETZ, BISTB0, BISTB1						
V _{IH}	High-Level Input Voltage		0.6×VDD1 P8GPIO			V
V _{IL}	Low-Level Input Voltage				0.4×VDD1 P8GPIO	V
I _{IH}	High-Level Input Current		-250		250	μA
I _{IL}	Low-Level Input Current		-250		250	μA
C _L	CMOS input capacitance			2		pF
V _{OH}	High-Level Output Voltage		VDD1P8G PIO-0.2			V
V _{OL}	Low-Level Output Voltage				0.2	V
Differential Inputs: SYSREF+/- Mode A						
F _{SYSREFMAX}	SYSREF Input Frequency Maximum			40		MHz
V _{SWINGSRMAX}	SYSREF Input Swing Maximum			1.8		Vppdiff ⁽²⁾
V _{SWINGSRMIN}	SYSREF Input Swing Minimum	f _{REF} < 500MHz		0.3		Vppdiff ⁽²⁾
V _{SWINGSRMIN}	SYSREF Input Swing Minimum	f _{REF} > 500MHz		0.6		Vppdiff ⁽²⁾
V _{COMSRMAX}	SYSREF Input Common Mode Voltage Maximum			0.8		V
V _{COMSRMIN}	SYSREF Input Common Mode Voltage Minimum			0.6		V
Z _T	Input termination	differential		100 ⁽¹⁾		Ω
C _L	Input capacitance	Each pin to GND		0.5		pF
LVDS Inputs: 0SYNCIN+/- and 1SYNCIN+/-						
V _{ICOM}	Input Common Voltage			1.2		V
V _{ID}	Differential Input Voltage swing			450		Vppdiff ⁽²⁾
Z _T	Input termination	differential		100		Ω
LVDS Outputs: 0SYNCOUT+/- and 1SYNCOUT+/-						
V _{OCOM}	Output Common Voltage			1.2		V
V _{OD}	Differential Output Voltage swing			500		Vppdiff ⁽²⁾
Z _T	Internal Termination			100		Ω

(1) SYSREF termination is programmable between 100Ω, 150Ω and 300Ω

(2) Vppdiff is the difference between the maximum differential voltage (positive value) and minimum differential voltage (negative value).

6.8 Power Supply Electrical Characteristics

Typical values at $T_A = +25^\circ\text{C}$, full temperature range is $T_{A,MIN} = -40^\circ\text{C}$ to $T_{J,MAX} = +110^\circ\text{C}$; $f_{ADC} = 2949.12\text{MSPS}$; nominal power supplies; 1 tone at -1 dBFS; DSA Attenuation = 0dB; SerDes rate = 24.33Gbps; unless otherwise noted.

PARAMETER		TEST CONDITIONS	MIN	TYP	MAX	UNIT
I_{VDD1P8}	Group 3A: VDD1P8FB + VDD1P8RX + VDD1P8TX	Mode 1: 4R, $f_{ADC} = 3\text{ GSPS}$, $DDC_{RX} = 6x$ Decimation, $f_{RX} = 1.85\text{ GHz}$, 8b/10b coding, 20 Gbps, RX: 4-8-4-1		673		mA
	Group 3B: VDD1P8FBCLK + VDD1P8RXCLK + VDD1P8TXDAC + VDD1P8GPIO + VDDA1P8			376		mA
	Group 3C: VDD1P8PLL + VDD1P8PLLVC0			17.5		mA
I_{VDD1P2}	Group 2A: VDD1P2FB + VDD1P2RX			557		mA
	Group 2B: VDD1P2TXCLK + VDD1P2TXENC			75		mA
	Group 2C: VDD1P2FBCML + VDD1P2RXCML + VDD1P2PLLCLKREF			68		mA
I_{VDD0P9}	Group 1A: DVDD0P9 + VDDT0P9			1582		mA
P_{diss}	Power Dissipation			4208		mW
I_{VDD1P8}	Group 3A: VDD1P8FB + VDD1P8RX + VDD1P8TX		Mode 2: 4R2F, $f_{ADC} = 3\text{ GSPS}$, $DDC_{FB} = DDC_{RX} = 6x$ Decimation, $f_{RX} = 1.85\text{ GHz}$, 8b/10b coding, 20 Gbps, RX: 4-8-4-1, FB: 2-4-4-1		1006	
	Group 3B: VDD1P8FBCLK + VDD1P8RXCLK + VDD1P8TXDAC + VDD1P8GPIO + VDDA1P8			548		mA
	Group 3C: VDD1P8PLL + VDD1P8PLLVC0			17.5		mA
I_{VDD1P2}	Group 2A: VDD1P2FB + VDD1P2RX			839		mA
	Group 2B: VDD1P2TXCLK + VDD1P2TXENC			92		mA
	Group 2C: VDD1P2FBCML + VDD1P2RXCML + VDD1P2PLLCLKREF			68		mA
I_{VDD0P9}	Group 1A: DVDD0P9 + VDDT0P9			2174		mA
P_{diss}	Power Dissipation			5996		mW
I_{VDD1P8}	Group 3A: VDD1P8FB + VDD1P8RX + VDD1P8TX	Mode 4: 4R, $f_{ADC} = 3\text{ GSPS}$, $DDC_{RX} = 2x$ Decimation, $f_{RX} = 2.25\text{ GHz}$, 64/66 coding, 24.75 Gbps, RX: 8-8-2-1			672	
	Group 3B: VDD1P8FBCLK + VDD1P8RXCLK + VDD1P8TXDAC + VDD1P8GPIO + VDDA1P8			506		mA
	Group 3C: VDD1P8PLL + VDD1P8PLLVC0			17.5		mA
I_{VDD1P2}	Group 2A: VDD1P2FB + VDD1P2RX			552		mA
	Group 2B: VDD1P2TXCLK + VDD1P2TXENC			76		mA
	Group 2C: VDD1P2FBCML + VDD1P2RXCML + VDD1P2PLLCLKREF			68		mA
I_{VDD0P9}	Group 1A: DVDD0P9 + VDDT0P9			1613		mA
P_{diss}	Power Dissipation			4468		mW

6.8 Power Supply Electrical Characteristics (continued)

Typical values at $T_A = +25^\circ\text{C}$, full temperature range is $T_{A,\text{MIN}} = -40^\circ\text{C}$ to $T_{J,\text{MAX}} = +110^\circ\text{C}$; $f_{\text{ADC}} = 2949.12\text{MSPS}$; nominal power supplies; 1 tone at -1 dBFS; DSA Attenuation = 0dB; SerDes rate = 24.33Gbps; unless otherwise noted.

PARAMETER		TEST CONDITIONS	MIN	TYP	MAX	UNIT	
I_{VDD1P8}	Group 3A: VDD1P8FB + VDD1P8RX + VDD1P8TX	Mode 5: 4R2F, $f_{\text{ADC}} = 3\text{GSPS}$, $\text{DDC}_{\text{RX}} = 12\text{x Decimation Dual Channel}$, $\text{DDC}_{\text{FB}} = 3\text{x Decimation}$, $f_{\text{RX}} = 1.85$ and 2.65GHz , 8b/10b coding, 20 Gbps, RX: 4-16-8-1, FB: 4-4-4-1		1005		mA	
	Group 3B: VDD1P8FBCLK + VDD1P8RXCLK + VDD1P8TXDAC+ VDD1P8GPIO + VDDA1P8			562		mA	
	Group 3C: VDD1P8PLL + VDD1P8PLLCO			17.5		mA	
I_{VDD1P2}	Group 2A: VDD1P2FB + VDD1P2RX				837		mA
	Group 2B: VDD1P2TXCLK + VDD1P2TXENC				92		mA
	Group 2C: VDD1P2FBCML + VDD1P2RXCML + VDD1P2PLLCLKREF				68		mA
I_{VDD0P9}	Group 1A: DVDD0P9 + VDDT0P9				2359		mA
P_{diss}	Power Dissipation				6195		mW
I_{VDD1P8}	Group 3A: VDD1P8FB + VDD1P8RX + VDD1P8TX		Mode 6: 4R, $f_{\text{ADC}} = 3\text{GSPS}$, $\text{DDC}_{\text{RX}} = 12\text{x Decimation Dual Channel}$, $f_{\text{RX}} = 1.85$ and 2.65GHz , 8b/10b coding, 20 Gbps, RX: 4-16-8-1		671		mA
	Group 3B: VDD1P8FBCLK + VDD1P8RXCLK + VDD1P8TXDAC+ VDD1P8GPIO + VDDA1P8			374		mA	
	Group 3C: VDD1P8PLL + VDD1P8PLLCO			17.5		mA	
I_{VDD1P2}	Group 2A: VDD1P2FB + VDD1P2RX				555		mA
	Group 2B: VDD1P2TXCLK + VDD1P2TXENC				75		mA
	Group 2C: VDD1P2FBCML + VDD1P2RXCML + VDD1P2PLLCLKREF				67		mA
I_{VDD0P9}	Group 1A: DVDD0P9 + VDDT0P9				1702		mA
P_{diss}	Power Dissipation				4305		mW
I_{VDD1P8}	Group 3A: VDD1P8FB + VDD1P8RX + VDD1P8TX	Mode 7: same configuration as mode 2, Sleep Mode. SLEEP pin is pull high.			16		mA
	Group 3B: VDD1P8FBCLK + VDD1P8RXCLK + VDD1P8TXDAC+ VDD1P8GPIO + VDDA1P8			295		mA	
	Group 3C: VDD1P8PLL + VDD1P8PLLCO			12		mA	
I_{VDD1P2}	Group 2A: VDD1P2FB + VDD1P2RX				4		mA
	Group 2B: VDD1P2TXCLK + VDD1P2TXENC				24		mA
	Group 2C: VDD1P2FBCML + VDD1P2RXCML + VDD1P2PLLCLKREF				45		mA
I_{VDD0P9}	Group 1A: DVDD0P9 + VDDT0P9				156		mA
P_{diss}	Power Dissipation				818		mW

6.9 Timing Requirements

Typical values at $T_A = +25^\circ\text{C}$, full temperature range is $T_{A,\text{MIN}} = -40^\circ\text{C}$ to $T_{J,\text{MAX}} = +110^\circ\text{C}$; $f_{\text{ADC}} = 2949.12\text{MSPS}$; nominal power supplies; 1 tone at -1 dBFS; DSA Attenuation = 0dB; SerDes rate = 24.33Gbps; unless otherwise noted.

		MIN	NOM	MAX	UNIT
Timing: SYSREF+/-					
$t_{\text{s}}(\text{SYSREF})$	Setup Time, SYSREF+/- Valid to Rising Edge of CLK+/-		50		ps
$t_{\text{h}}(\text{SYSREF})$	Hold Time, SYSREF+/- Valid after Rising Edge of CLK+/-		50		ps
Timing: Serial ports					
$t_{\text{s}}(\text{SENB})$	Setup Time, SENB to Rising Edge of SCLK		15		ns
$t_{\text{h}}(\text{SENB})$	Hold Time, SENB after last Rising Edge of SCLK ⁽¹⁾		$5 + t_{\text{s}}(\text{SCLK})$		ns
$t_{\text{s}}(\text{SDIO})$	Setup Time, SDIO valid to Rising Edge of SCLK		15		ns
$t_{\text{h}}(\text{SDIO})$	Hold Time, SDIO valid after Rising Edge of SCLK		5		ns
$t_{\text{s}}(\text{SCLK})_{\text{W}}$	Minimum SCLK period: registers write		25		ns
$t_{\text{s}}(\text{SCLK})_{\text{R}}$	Minimum SCLK period: registers read		50		ns
$t_{\text{d}}(\text{data}_{\text{out}})$	Minimum Data Output delay after Falling Edge of SCLK		0		ns
	Maximum Data Output delay after Falling Edge of SCLK		15		ns
t_{RESET}	Minimum RESETZ Pulse Width		1		ms

(1) SDEN\ need to be held one more extra clock cycle with the last SCLK edge

6.10 Switching Characteristics

Typical values at $T_A = +25^\circ\text{C}$, full temperature range is $T_{A,MIN} = -40^\circ\text{C}$ to $T_{J,MAX} = +110^\circ\text{C}$; $f_{ADC} = 2949.12\text{MSPS}$; nominal power supplies; 1 tone at -1 dBFS; DSA Attenuation = 0dB; SerDes rate = 24.33Gbps; unless otherwise noted.

PARAMETER		TEST CONDITIONS	MIN	TYP	MAX	UNIT
RX Channel Latency						
t_{JESDRX}	RX input to JESD output Latency	LMFS=2-16-16-1, 122.88 MSPS, 24x Decimation, Serdes rate = 16.22Gbps (JESD204C)		92		interface clock cycles ⁽¹⁾
		LMFS=4-16-8-1, 245.76 MSPS, 12x Decimation, Serdes rate = 16.22Gbps (JESD204C)		108		
		LMFS=2-8-8-1, 368.64 MSPS, 8x Decimation, Serdes rate = 16.22Gbps (JESD204C)		118		
		LMFS=4-8-4-1, 491.52 MSPS, 6x Decimation, Serdes rate = 16.22Gbps (JESD204C)		153		
FB Channel Latency						
	SerDes Transmitter Analog Delay			3.6		ns
t_{JESDFB}	FB input to JESD output Latency	LMFS=1-2-8-1, 368.64 MSPS, 8x Decimation		151		interface clock cycles ⁽¹⁾
		LMFS=2-4-4-1, 491.52 MSPS, 6x Decimation		177		

(1) Interface clock cycles is the period of the digital interface clock rate, e.g. 1GSPS = 1ns.

6.11.1 RX Typical Characteristics 30 MHz and 400 MHz

Typical values at $T_A = +25^\circ\text{C}$. Default conditions at 30MHz: ADC Sampling Rate = 1500 MSPS, output sample rate = 62.5 MSPS (decimate by 24x), PLL clock mode with $f_{REF} = 500$ MHz, $A_{IN} = -3$ dBFS, DSA setting = 3 dB. Default conditions at 400 MHz: ADC Sampling Rate = 1500 MSPS, output sample rate = 125 MSPS (decimate by 12x), PLL clock mode with $f_{REF} = 500$ MHz, $A_{IN} = -3$ dBFS, DSA setting = 3 dB.

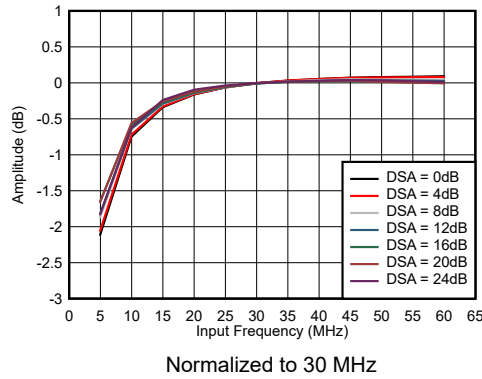

Figure 6-1. RX In-Band Gain Flatness, $f_{IN} = 30$ MHz

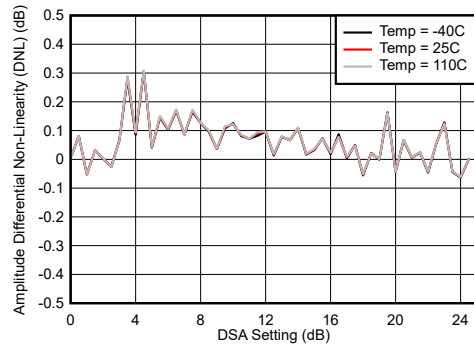

Figure 6-2. RX Uncalibrated Differential Amplitude Error vs DSA Setting at 30 MHz
Differential Amplitude Error = $P_{IN}(\text{DSA Setting} - 1) - P_{IN}(\text{DSA Setting}) + 1$

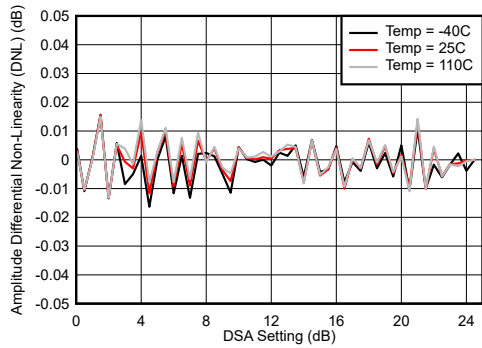

Figure 6-3. RX Calibrated Differential Amplitude Error vs DSA Setting at 30 MHz
Differential Amplitude Error = $P_{IN}(\text{DSA Setting} - 1) - P_{IN}(\text{DSA Setting}) + 1$

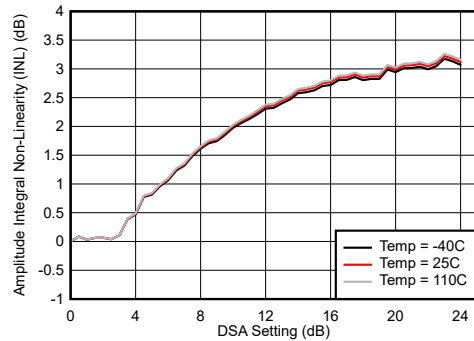

Figure 6-4. RX Uncalibrated Integrated Amplitude Error vs DSA Setting at 30 MHz
Integrated Amplitude Error = $P_{IN}(\text{DSA Setting}) - P_{IN}(\text{DSA Setting} = 0) + (\text{DSA Setting})$

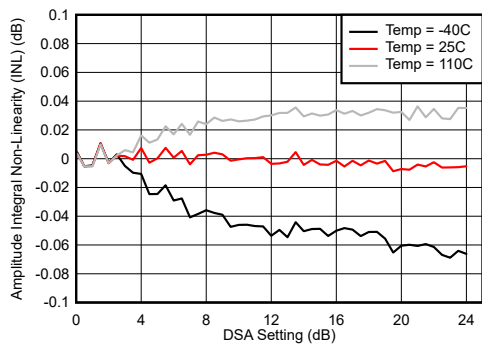

Figure 6-5. RX Calibrated Integrated Amplitude Error vs DSA Setting at 30 MHz
Integrated Amplitude Error = $P_{IN}(\text{DSA Setting}) - P_{IN}(\text{DSA Setting} = 0) + (\text{DSA Setting})$

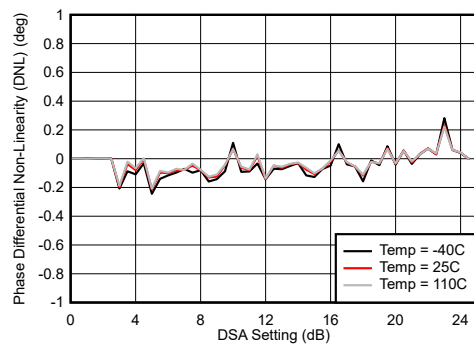
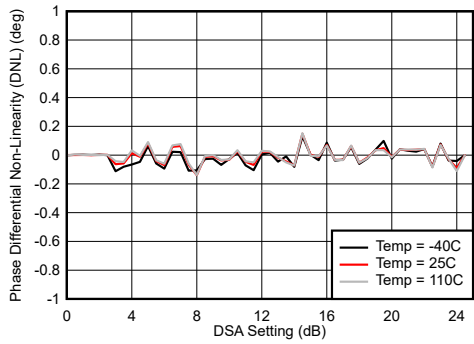

Figure 6-6. RX Uncalibrated Differential Phase Error vs DSA Setting at 30 MHz
Differential Phase Error = $\text{Phase}_{IN}(\text{DSA Setting} - 1) - \text{Phase}_{IN}(\text{DSA Setting})$

6.11.1 RX Typical Characteristics 30 MHz and 400 MHz (continued)

Typical values at $T_A = +25^\circ\text{C}$. Default conditions at 30MHz: ADC Sampling Rate = 1500 MSPS, output sample rate = 62.5 MSPS (decimate by 24x), PLL clock mode with $f_{REF} = 500\text{ MHz}$, $A_{IN} = -3\text{ dBFS}$, DSA setting = 3 dB. Default conditions at 400 MHz: ADC Sampling Rate = 1500 MSPS, output sample rate = 125 MSPS (decimate by 12x), PLL clock mode with $f_{REF} = 500\text{ MHz}$, $A_{IN} = -3\text{ dBFS}$, DSA setting = 3 dB.



$$\text{Differential Phase Error} = \text{Phase}_{IN}(\text{DSA Setting} - 1) - \text{Phase}_{IN}(\text{DSA Setting})$$

Figure 6-7. RX Calibrated Differential Phase Error vs DSA Setting at 30 MHz

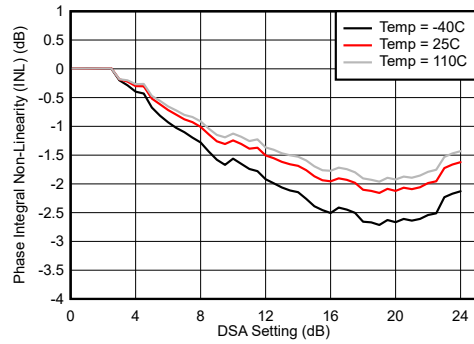

$$\text{Integrated Phase Error} = \text{Phase}(\text{DSA Setting}) - \text{Phase}(\text{DSA Setting} = 0)$$

Figure 6-8. RX Uncalibrated Integrated Phase Error vs DSA Setting at 30 MHz

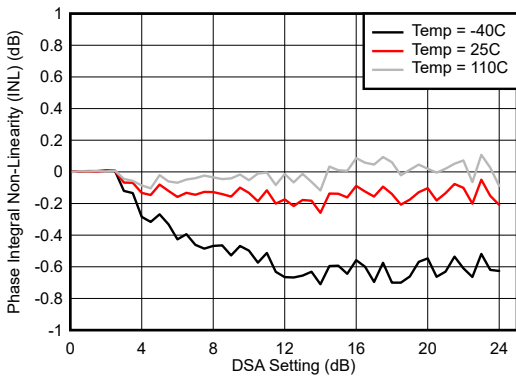

With 0.8 GHz matching
 $\text{Integrated Phase Error} = \text{Phase}(\text{DSA Setting}) - \text{Phase}(\text{DSA Setting} = 0)$

Figure 6-9. RX Calibrated Integrated Phase Error vs DSA Setting at 30 MHz

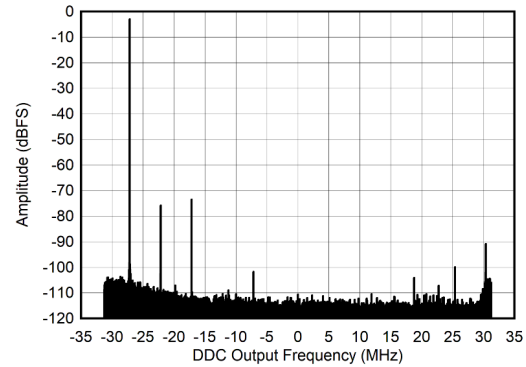

$A_{IN} = -3\text{ dBFS}$, $f_{ADC} = 1500\text{ MSPS}$, $f_{NCO} = 32.13\text{ MHz}$,
 Decimate by 24x

Figure 6-10. RX Output FFT at 5 MHz

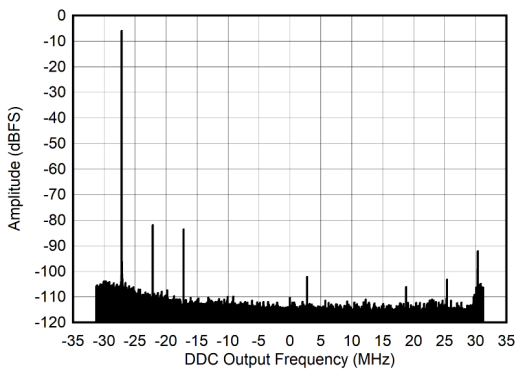

$A_{IN} = -6\text{ dBFS}$, $f_{ADC} = 1500\text{ MSPS}$, $f_{NCO} = 32.$, Decimate by 24x

Figure 6-11. RX Output FFT at 5 MHz

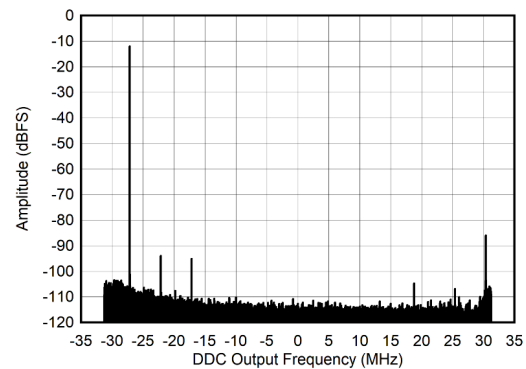

$A_{IN} = -12\text{ dBFS}$, $f_{ADC} = 1500\text{ MSPS}$, $f_{NCO} = 32.13\text{ MHz}$,
 Decimate by 24x

Figure 6-12. RX Output FFT at 5 MHz

6.11.1 RX Typical Characteristics 30 MHz and 400 MHz (continued)

Typical values at $T_A = +25^\circ\text{C}$. Default conditions at 30MHz: ADC Sampling Rate = 1500 MSPS, output sample rate = 62.5 MSPS (decimate by 24x), PLL clock mode with $f_{REF} = 500\text{ MHz}$, $A_{IN} = -3\text{ dBFS}$, DSA setting = 3 dB. Default conditions at 400 MHz: ADC Sampling Rate = 1500 MSPS, output sample rate = 125 MSPS (decimate by 12x), PLL clock mode with $f_{REF} = 500\text{ MHz}$, $A_{IN} = -3\text{ dBFS}$, DSA setting = 3 dB.

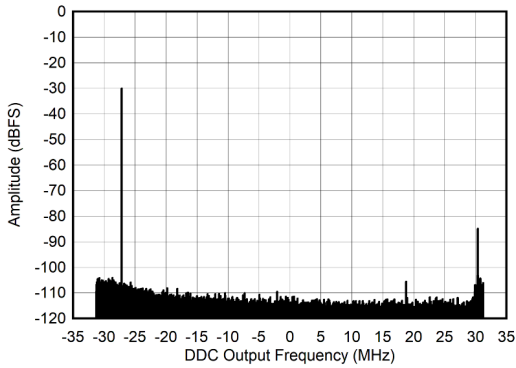

$A_{IN} = -30\text{ dBFS}$, $f_{ADC} = 1500\text{ MSPS}$, $f_{NCO} = 32.13\text{ MHz}$,
Decimate by 24x

Figure 6-13. RX Output FFT at 5 MHz

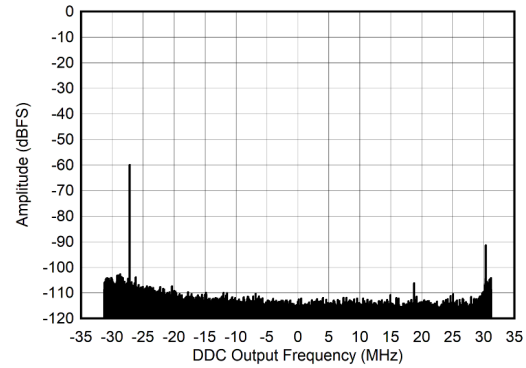

$A_{IN} = -60\text{ dBFS}$, $f_{ADC} = 1500\text{ MSPS}$, $f_{NCO} = 32.13\text{ MHz}$,
Decimate by 24x

Figure 6-14. RX Output FFT at 5 MHz

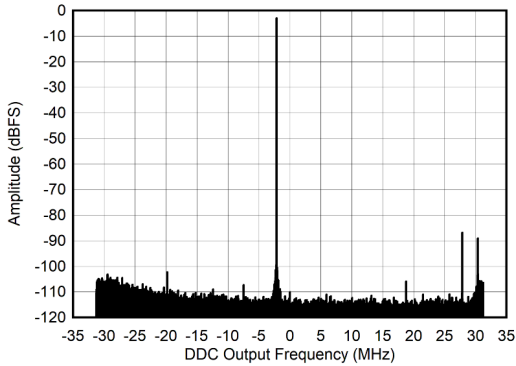

$A_{IN} = -3\text{ dBFS}$, $f_{ADC} = 1500\text{ MSPS}$, $f_{NCO} = 32.13\text{ MHz}$,
Decimate by 24x

Figure 6-15. RX Output FFT at 30 MHz

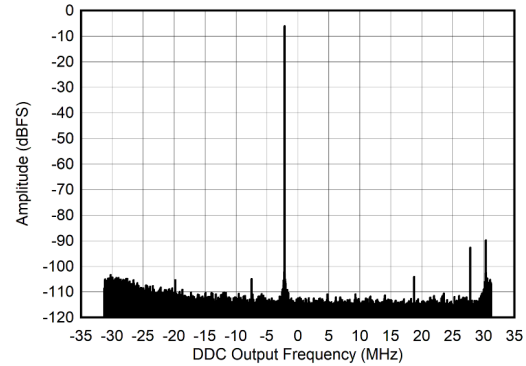

$A_{IN} = -6\text{ dBFS}$, $f_{ADC} = 1500\text{ MSPS}$, $f_{NCO} = 32.13\text{ MHz}$,
Decimate by 24x

Figure 6-16. RX Output FFT at 30 MHz

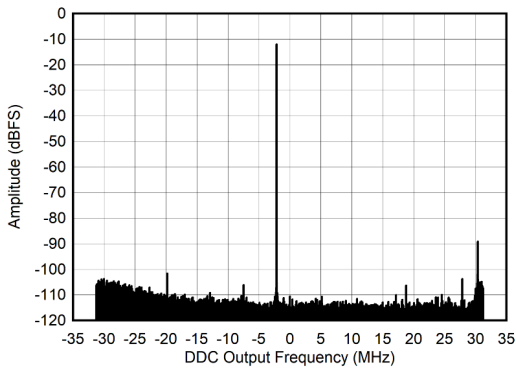

$A_{IN} = -12\text{ dBFS}$, $f_{ADC} = 1500\text{ MSPS}$, $f_{NCO} = 32.13\text{ MHz}$,
Decimate by 24x

Figure 6-17. RX Output FFT at 30 MHz

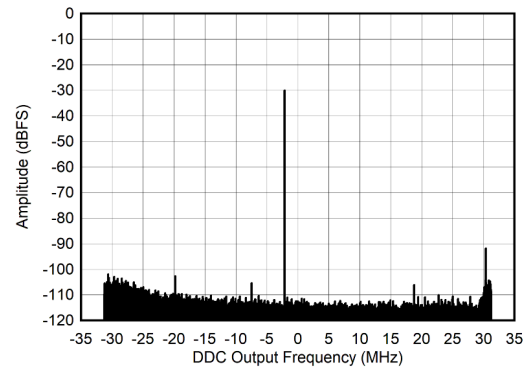

$A_{IN} = -30\text{ dBFS}$, $f_{ADC} = 1500\text{ MSPS}$, $f_{NCO} = 32.13\text{ MHz}$,
Decimate by 24x

Figure 6-18. RX Output FFT at 30 MHz

6.11.1 RX Typical Characteristics 30 MHz and 400 MHz (continued)

Typical values at $T_A = +25^\circ\text{C}$. Default conditions at 30MHz: ADC Sampling Rate = 1500 MSPS, output sample rate = 62.5 MSPS (decimate by 24x), PLL clock mode with $f_{REF} = 500\text{ MHz}$, $A_{IN} = -3\text{ dBFS}$, DSA setting = 3 dB. Default conditions at 400 MHz: ADC Sampling Rate = 1500 MSPS, output sample rate = 125 MSPS (decimate by 12x), PLL clock mode with $f_{REF} = 500\text{ MHz}$, $A_{IN} = -3\text{ dBFS}$, DSA setting = 3 dB.

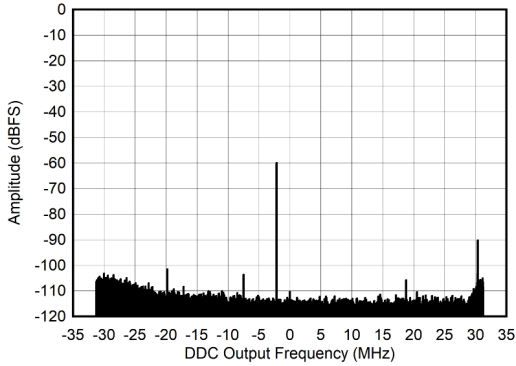

$A_{IN} = -60\text{ dBFS}$, $f_{ADC} = 1500\text{ MSPS}$, $f_{NCO} = 32.13\text{ MHz}$, Decimate by 24x

Figure 6-19. RX Output FFT at 30 MHz

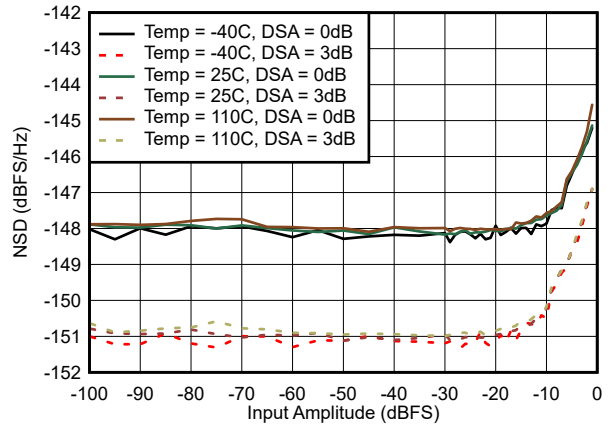

$f_{ADC} = 1500\text{ MSPS}$, $f_{NCO} = 32.13\text{ MHz}$, Decimate by 24x

Figure 6-20. NSD vs Input Amplitude at 30 MHz with DSA = 0 and 3dB

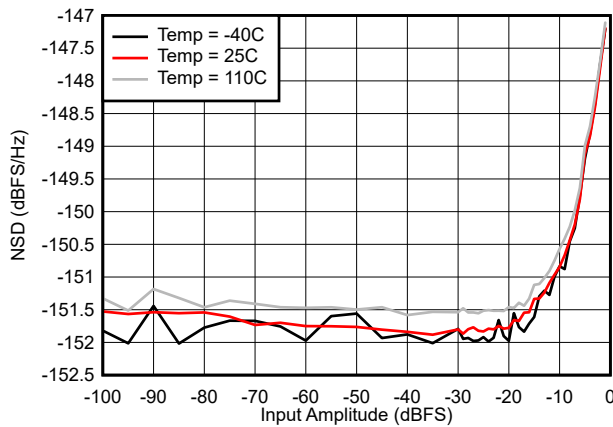

$f_{ADC} = 1500\text{ MSPS}$, $f_{NCO} = 32.13\text{ MHz}$, Decimate by 24x

Figure 6-21. NSD vs Input Amplitude at 30 MHz with DSA = 12

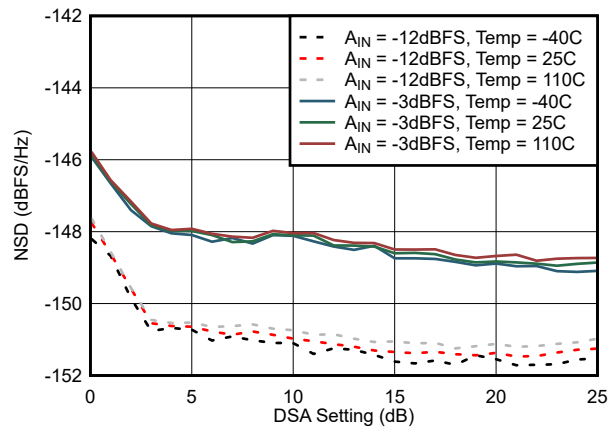

$f_{ADC} = 1500\text{ MSPS}$, $f_{NCO} = 32.13\text{ MHz}$, Decimate by 24x

Figure 6-22. NSD vs DSA Attenuation at 30 MHz

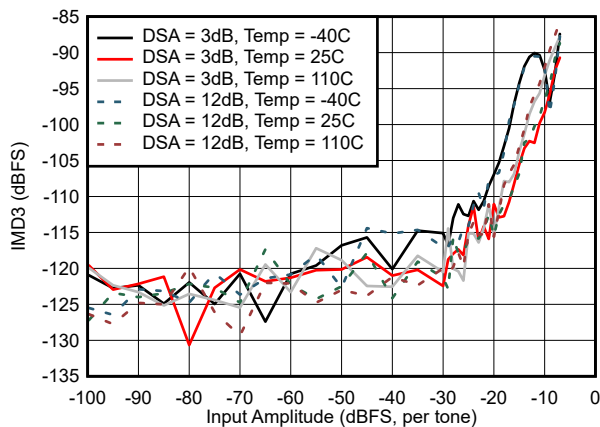

$f_{ADC} = 1500\text{ MSPS}$, $f_{NCO} = 32.13\text{ MHz}$, Decimate by 24x

Figure 6-23. IMD3 vs Input Amplitude at 30 MHz

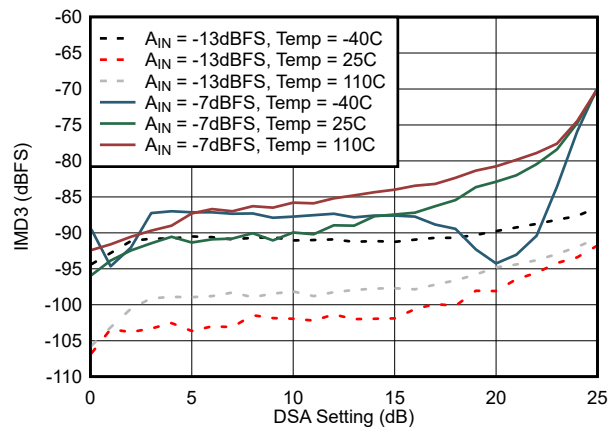

$f_{ADC} = 1500\text{ MSPS}$, $f_{NCO} = 32.13\text{ MHz}$, Decimate by 24x

Figure 6-24. IMD3 vs DSA Setting at 30 MHz

6.11.1 RX Typical Characteristics 30 MHz and 400 MHz (continued)

Typical values at $T_A = +25^\circ\text{C}$. Default conditions at 30MHz: ADC Sampling Rate = 1500 MSPS, output sample rate = 62.5 MSPS (decimate by 24x), PLL clock mode with $f_{\text{REF}} = 500$ MHz, $A_{\text{IN}} = -3$ dBFS, DSA setting = 3 dB. Default conditions at 400 MHz: ADC Sampling Rate = 1500 MSPS, output sample rate = 125 MSPS (decimate by 12x), PLL clock mode with $f_{\text{REF}} = 500$ MHz, $A_{\text{IN}} = -3$ dBFS, DSA setting = 3 dB.

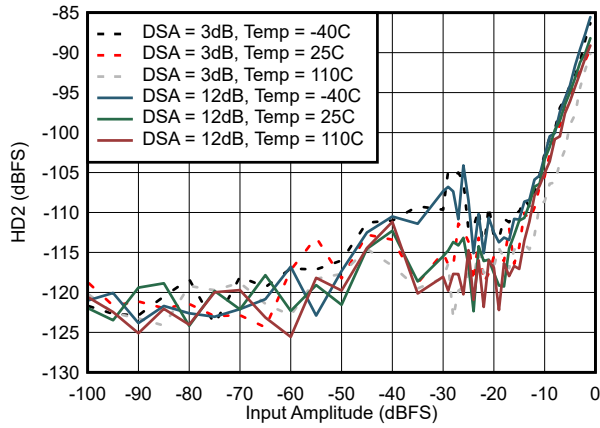

$f_{\text{ADC}} = 1500$ MSPS, $f_{\text{NCO}} = 32.13$ MHz, Decimate by 24x

Figure 6-25. HD2 vs Input Amplitude at 30 MHz

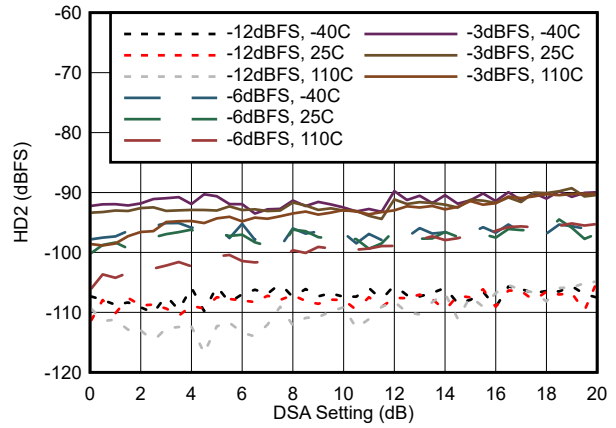

$f_{\text{ADC}} = 1500$ MSPS, $f_{\text{NCO}} = 32.$, Decimate by 24x

Figure 6-26. HD2 vs DSA Setting at 30 MHz

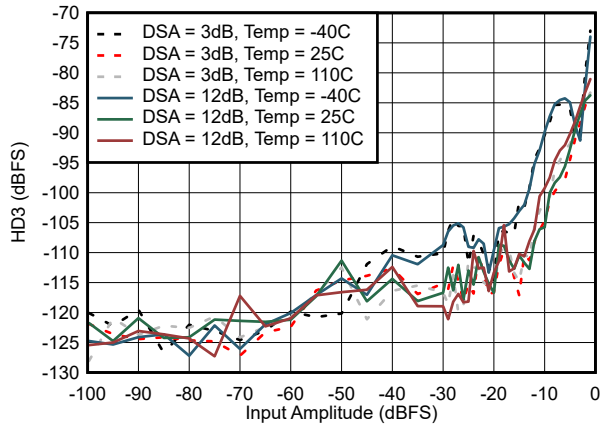

$f_{\text{ADC}} = 1500$ MSPS, $f_{\text{NCO}} = 32.13$ MHz, Decimate by 24x

Figure 6-27. HD3 vs Input Amplitude at 30 MHz

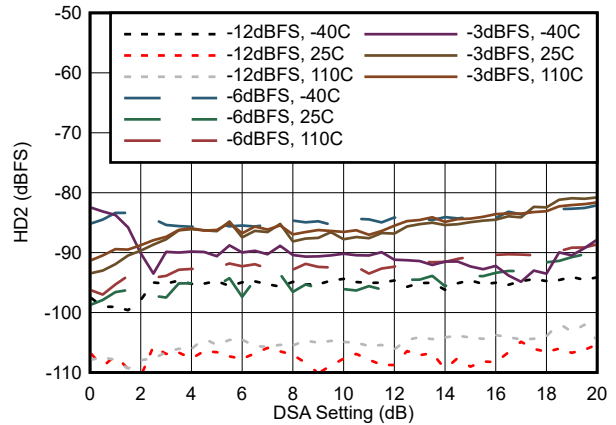

$f_{\text{ADC}} = 1500$ MSPS, $f_{\text{NCO}} = 32.13$ MHz, Decimate by 24x

Figure 6-28. HD3 vs DSA Setting at 30 MHz

6.11.1 RX Typical Characteristics 30 MHz and 400 MHz (continued)

Typical values at $T_A = +25^\circ\text{C}$. Default conditions at 30MHz: ADC Sampling Rate = 1500 MSPS, output sample rate = 62.5 MSPS (decimate by 24x), PLL clock mode with $f_{REF} = 500$ MHz, $A_{IN} = -3$ dBFS, DSA setting = 3 dB. Default conditions at 400 MHz: ADC Sampling Rate = 1500 MSPS, output sample rate = 125 MSPS (decimate by 12x), PLL clock mode with $f_{REF} = 500$ MHz, $A_{IN} = -3$ dBFS, DSA setting = 3 dB.

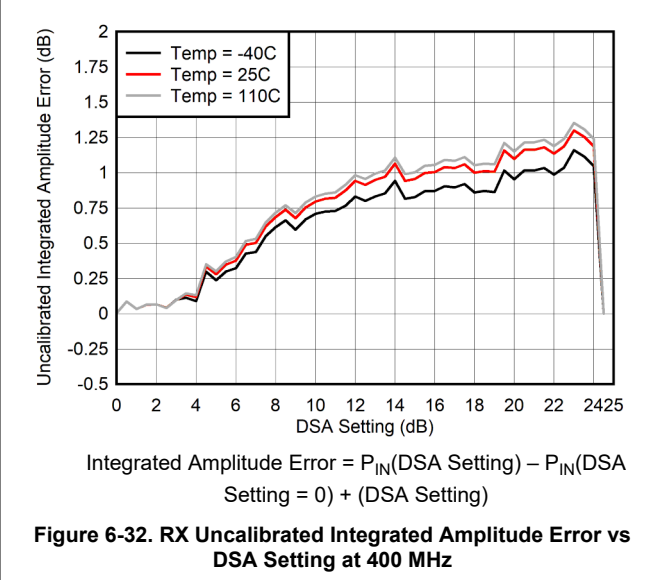
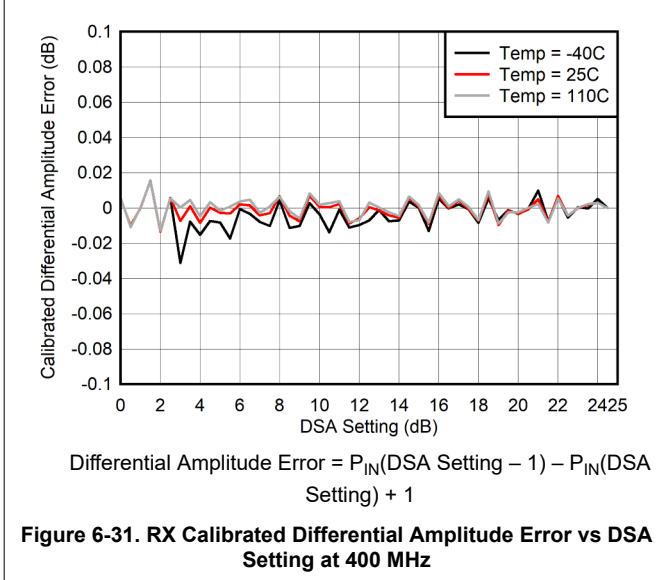
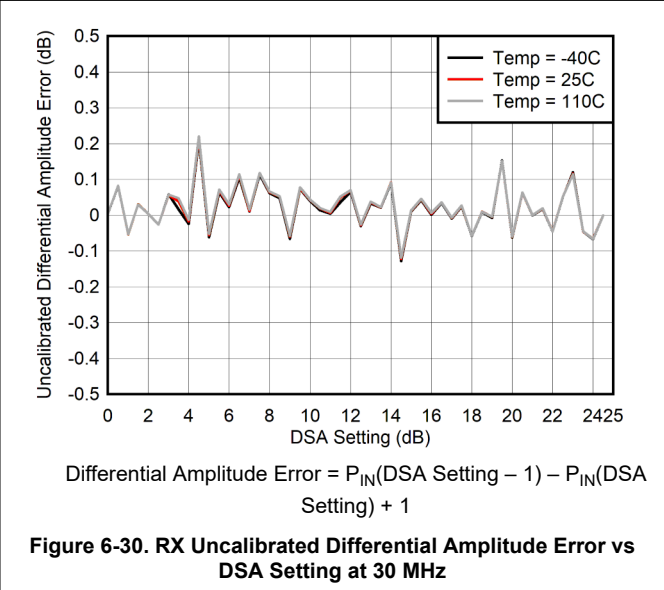
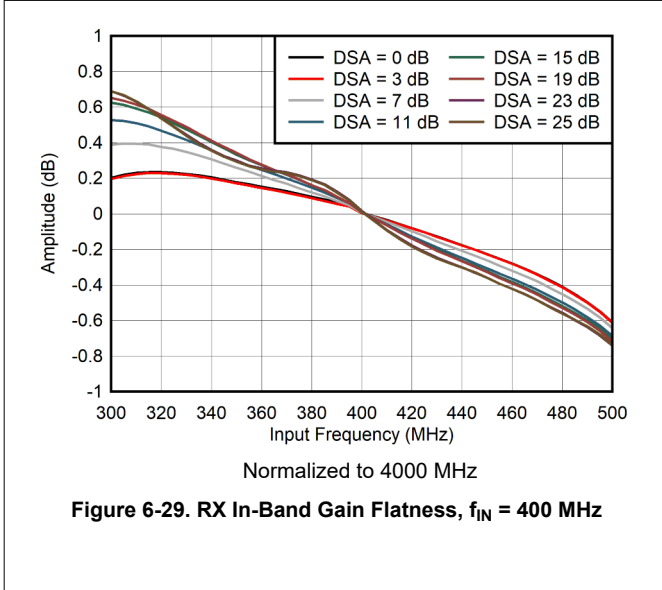

6.11.1 RX Typical Characteristics 30 MHz and 400 MHz (continued)

Typical values at $T_A = +25^\circ\text{C}$. Default conditions at 30MHz: ADC Sampling Rate = 1500 MSPS, output sample rate = 62.5 MSPS (decimate by 24x), PLL clock mode with $f_{REF} = 500$ MHz, $A_{IN} = -3$ dBFS, DSA setting = 3 dB. Default conditions at 400 MHz: ADC Sampling Rate = 1500 MSPS, output sample rate = 125 MSPS (decimate by 12x), PLL clock mode with $f_{REF} = 500$ MHz, $A_{IN} = -3$ dBFS, DSA setting = 3 dB.

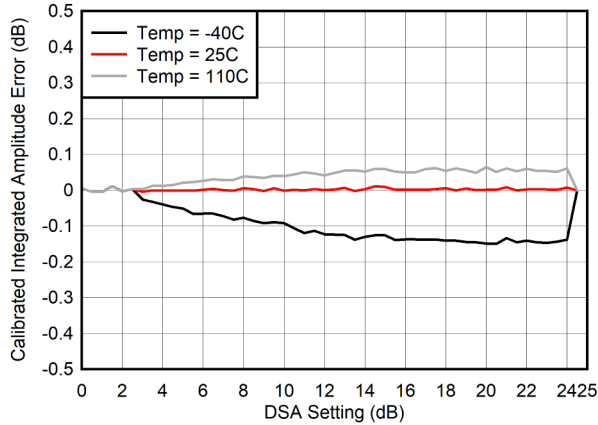

$$\text{Integrated Amplitude Error} = P_{IN}(\text{DSA Setting}) - P_{IN}(\text{DSA Setting} = 0) + (\text{DSA Setting})$$

Figure 6-33. RX Calibrated Integrated Amplitude Error vs DSA Setting at 400 MHz

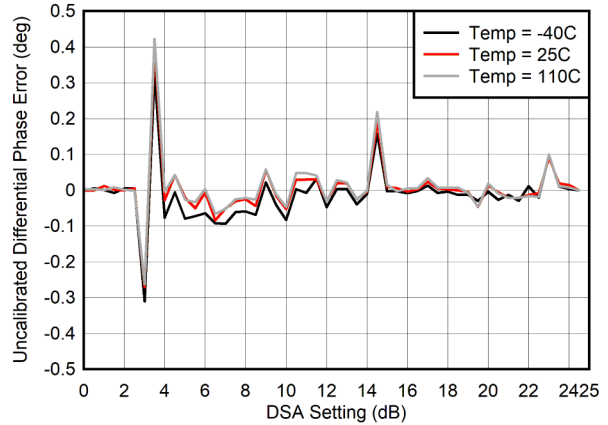

$$\text{Differential Phase Error} = \text{Phase}_{IN}(\text{DSA Setting} - 1) - \text{Phase}_{IN}(\text{DSA Setting})$$

Figure 6-34. RX Uncalibrated Differential Phase Error vs DSA Setting at 400 MHz

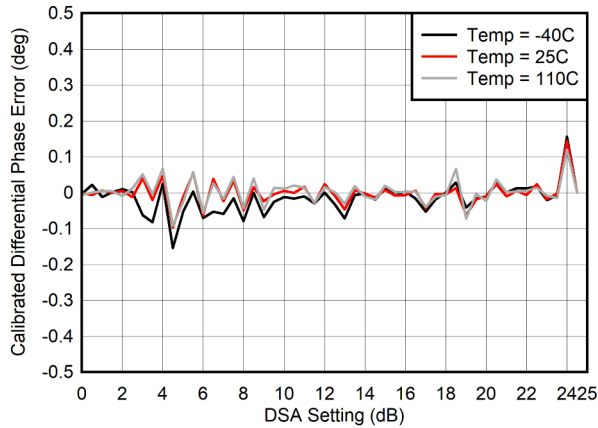

$$\text{Differential Phase Error} = \text{Phase}_{IN}(\text{DSA Setting} - 1) - \text{Phase}_{IN}(\text{DSA Setting})$$

Figure 6-35. RX Calibrated Differential Phase Error vs DSA Setting at 400 MHz

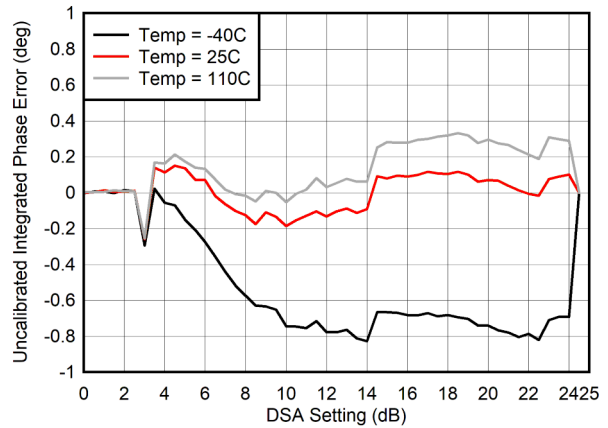

$$\text{Integrated Phase Error} = \text{Phase}(\text{DSA Setting}) - \text{Phase}(\text{DSA Setting} = 0)$$

Figure 6-36. RX Uncalibrated Integrated Phase Error vs DSA Setting at 400 MHz

6.11.1 RX Typical Characteristics 30 MHz and 400 MHz (continued)

Typical values at $T_A = +25^\circ\text{C}$. Default conditions at 30MHz: ADC Sampling Rate = 1500 MSPS, output sample rate = 62.5 MSPS (decimate by 24x), PLL clock mode with $f_{REF} = 500\text{ MHz}$, $A_{IN} = -3\text{ dBFS}$, DSA setting = 3 dB. Default conditions at 400 MHz: ADC Sampling Rate = 1500 MSPS, output sample rate = 125 MSPS (decimate by 12x), PLL clock mode with $f_{REF} = 500\text{ MHz}$, $A_{IN} = -3\text{ dBFS}$, DSA setting = 3 dB.

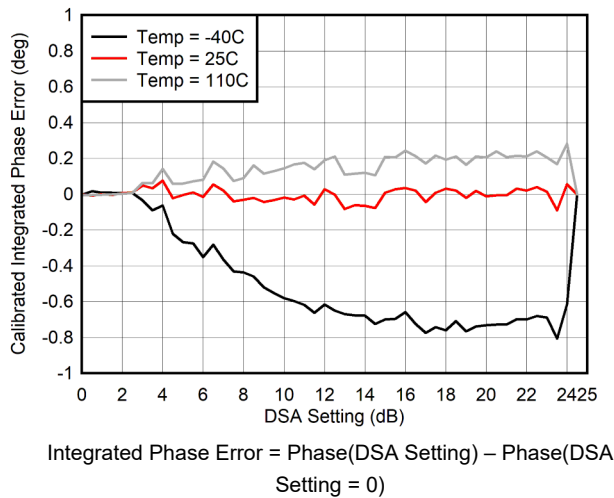
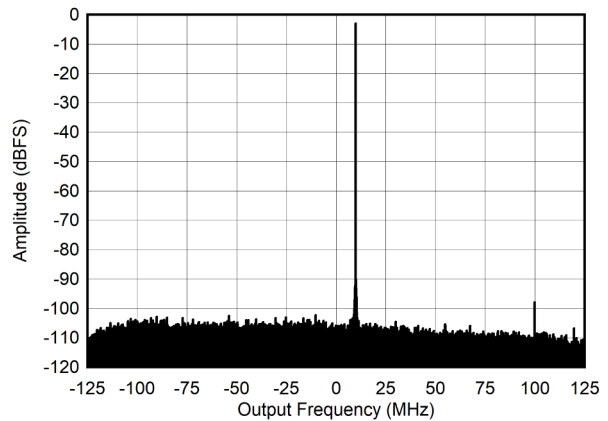
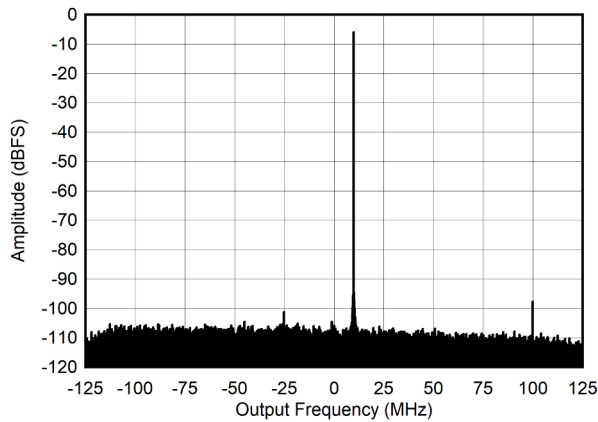

Figure 6-37. RX Calibrated Integrated Phase Error vs DSA Setting at 400 MHz



$f_{NCO} = 400\text{MHz}$

Figure 6-38. RX Output FFT at 405 MHz and -3dBFS



$f_{NCO} = 400\text{MHz}$

Figure 6-39. RX Output FFT at 405 MHz and -6dBFS

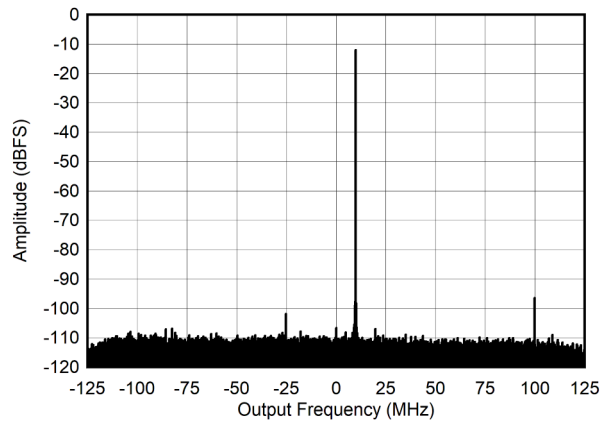

$f_{NCO} = 400\text{MHz}$

Figure 6-40. RX Output FFT at 405 MHz and -12dBFS

6.11.1 RX Typical Characteristics 30 MHz and 400 MHz (continued)

Typical values at $T_A = +25^\circ\text{C}$. Default conditions at 30MHz: ADC Sampling Rate = 1500 MSPS, output sample rate = 62.5 MSPS (decimate by 24x), PLL clock mode with $f_{\text{REF}} = 500\text{ MHz}$, $A_{\text{IN}} = -3\text{ dBFS}$, DSA setting = 3 dB. Default conditions at 400 MHz: ADC Sampling Rate = 1500 MSPS, output sample rate = 125 MSPS (decimate by 12x), PLL clock mode with $f_{\text{REF}} = 500\text{ MHz}$, $A_{\text{IN}} = -3\text{ dBFS}$, DSA setting = 3 dB.

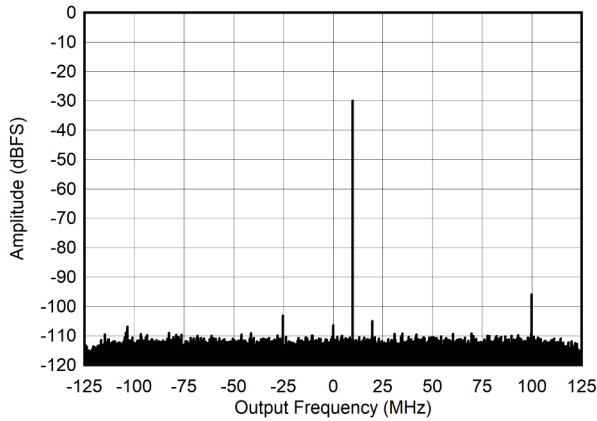

$f_{\text{NCO}} = 400\text{MHz}$

Figure 6-41. RX Output FFT at 405 MHz and -30dBFS

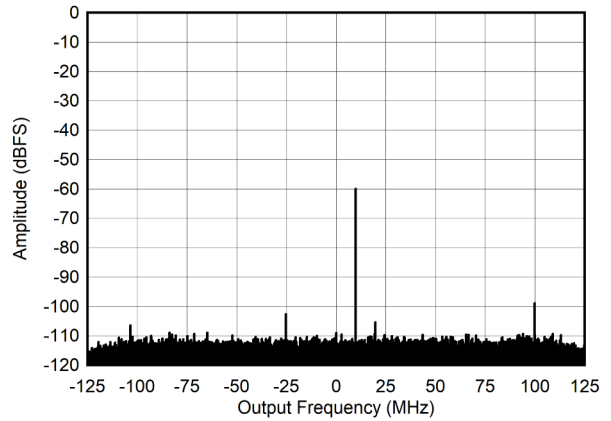

$f_{\text{NCO}} = 400\text{MHz}$

Figure 6-42. RX Output FFT at 405 MHz and -60dBFS

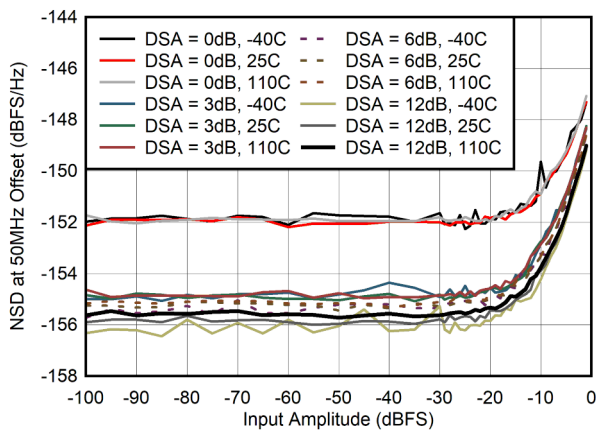

$f_{\text{OFFSET}} = 50\text{MHz}$

Figure 6-43. NSD vs Input Amplitude at 400MHz

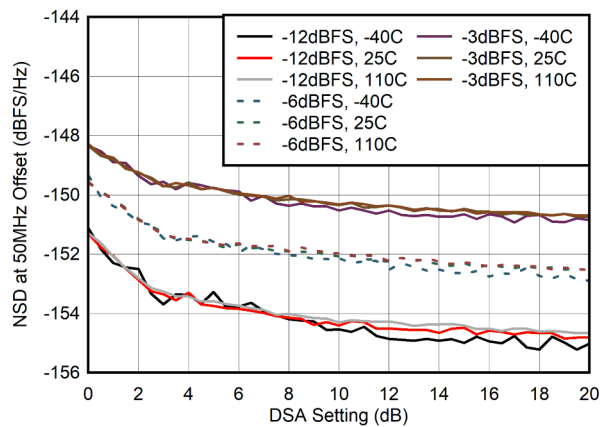

$f_{\text{OFFSET}} = 50\text{MHz}$

Figure 6-44. NSD vs DSA Setting at 400MHz

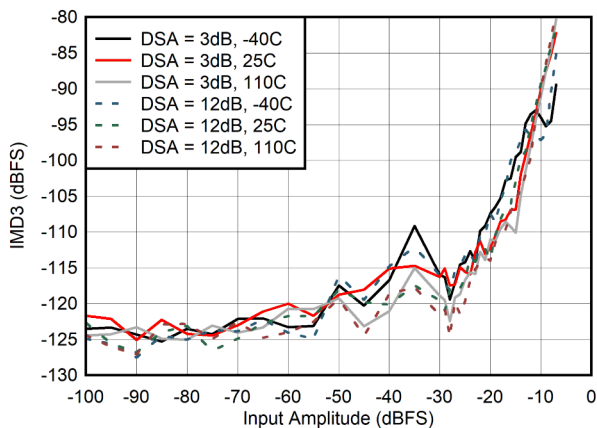

Figure 6-45. IMD3 vs Input Amplitude at 400MHz

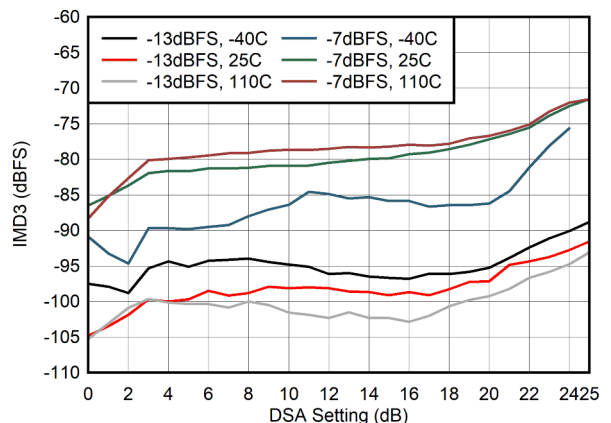
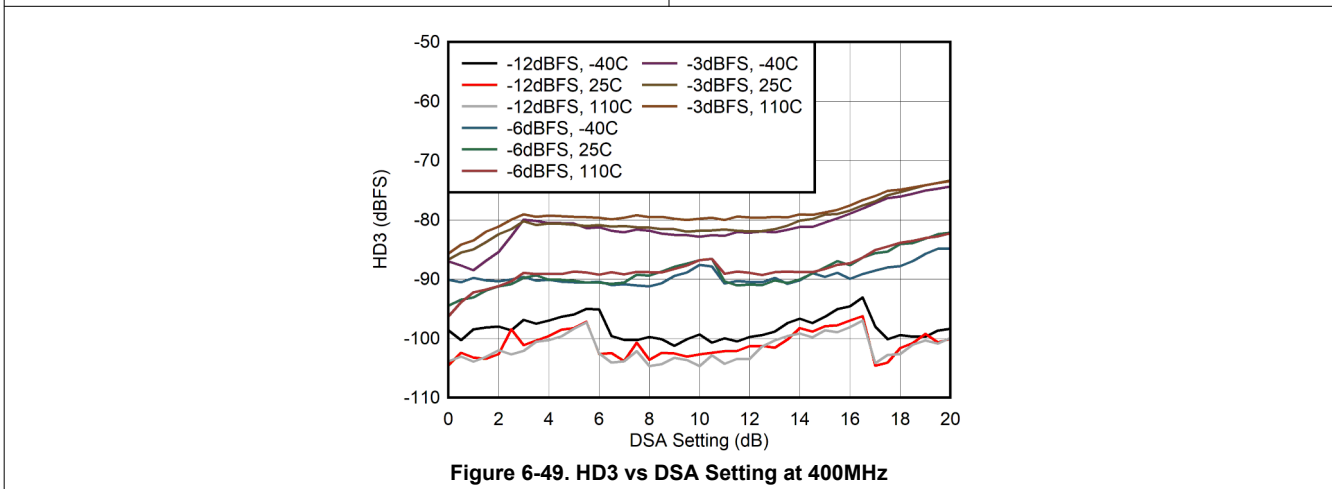
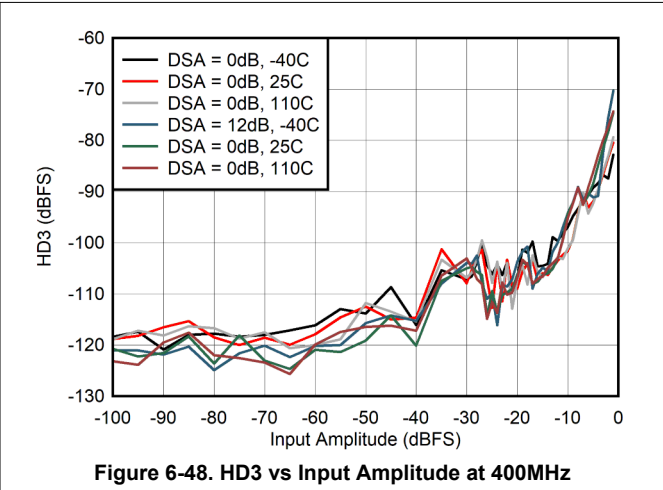
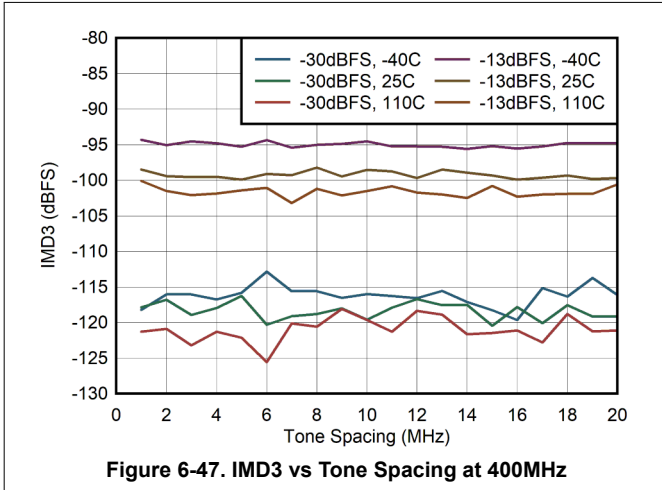

Figure 6-46. IMD3 vs DSA Setting at 400MHz

6.11.1 RX Typical Characteristics 30 MHz and 400 MHz (continued)

Typical values at $T_A = +25^\circ\text{C}$. Default conditions at 30MHz: ADC Sampling Rate = 1500 MSPS, output sample rate = 62.5 MSPS (decimate by 24x), PLL clock mode with $f_{REF} = 500\text{ MHz}$, $A_{IN} = -3\text{ dBFS}$, DSA setting = 3 dB. Default conditions at 400 MHz: ADC Sampling Rate = 1500 MSPS, output sample rate = 125 MSPS (decimate by 12x), PLL clock mode with $f_{REF} = 500\text{ MHz}$, $A_{IN} = -3\text{ dBFS}$, DSA setting = 3 dB.



6.11.2 RX Typical Characteristics at 800MHz

Typical values at $T_A = +25^\circ\text{C}$, ADC Sampling Rate = 2949.12 GHz. Default conditions: output sample rate = 491.52MSPS (decimate by 6), PLL clock mode with $f_{REF} = 491.52\text{MHz}$, $A_{IN} = -3\text{dBFS}$, DSA setting = 4 dB.

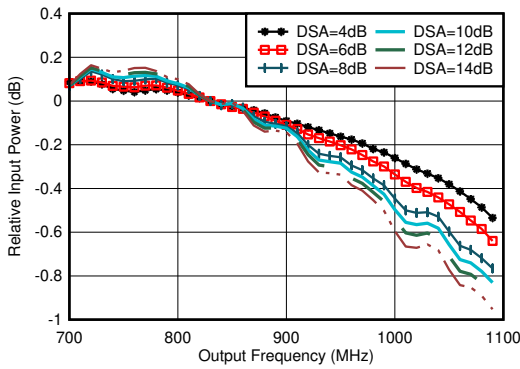

With 0.8 GHz matching, normalized to 830 MHz

Figure 6-50. RX In-Band Gain Flatness for Channel 1RX, $f_{IN} = 830\text{ MHz}$

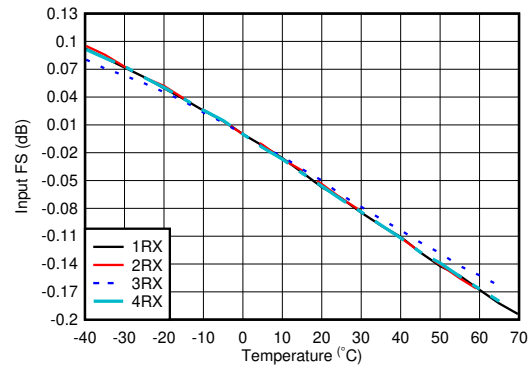

With 0.8 GHz matching, normalized to fullscale at 25°C for each channel

Figure 6-51. RX Input Fullscale vs Temperature and Channel at 800MHz

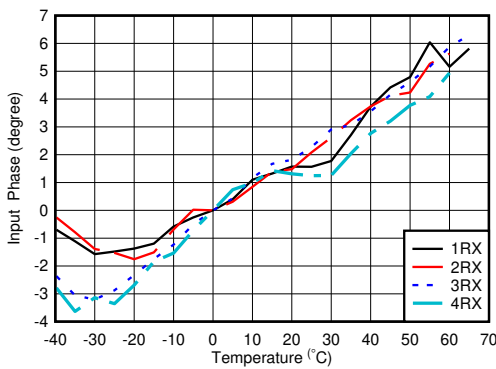

With 0.8 GHz matching, normalized to phase at 25°C

Figure 6-52. RX Input Phase vs Temperature and DSA at $f_{OUT} = 0.8\text{ GHz}$

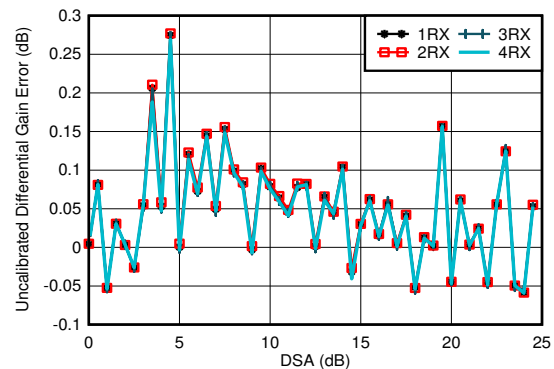

With 0.8 GHz matching

Differential Amplitude Error = $P_{IN}(\text{DSA Setting} - 1) - P_{IN}(\text{DSA Setting}) + 1$

Figure 6-53. RX Uncalibrated Differential Amplitude Error vs DSA Setting at 0.8 GHz

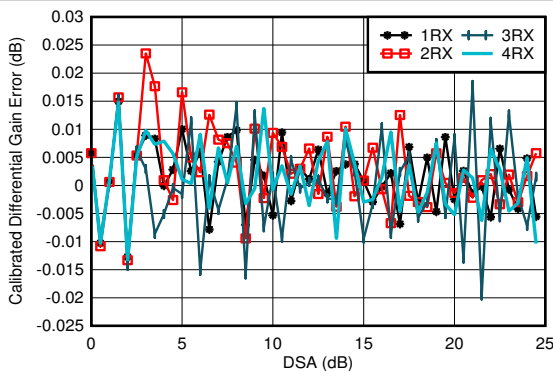

With 0.8 GHz matching

Differential Amplitude Error = $P_{IN}(\text{DSA Setting} - 1) - P_{IN}(\text{DSA Setting}) + 1$

Figure 6-54. RX Calibrated Differential Amplitude Error vs DSA Setting at 0.8 GHz

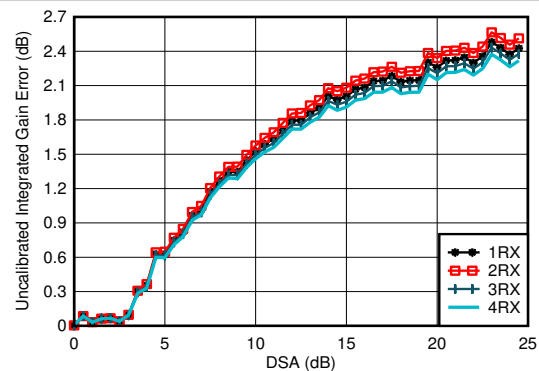

With 0.8 GHz matching

Integrated Amplitude Error = $P_{IN}(\text{DSA Setting}) - P_{IN}(\text{DSA Setting} = 0) + (\text{DSA Setting})$

Figure 6-55. RX Uncalibrated Integrated Amplitude Error vs DSA Setting at 0.8 GHz

6.11.2 RX Typical Characteristics at 800MHz (continued)

Typical values at $T_A = +25^\circ\text{C}$, ADC Sampling Rate = 2949.12 GHz. Default conditions: output sample rate = 491.52MSPS (decimate by 6), PLL clock mode with $f_{REF} = 491.52\text{MHz}$, $A_{IN} = -3\text{ dBFS}$, DSA setting = 4 dB.

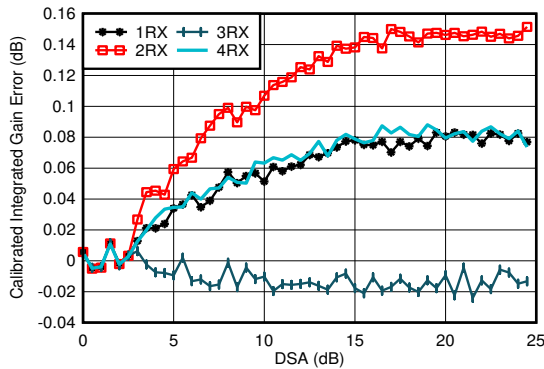

With 0.8 GHz matching
 Integrated Amplitude Error = $P_{IN}(\text{DSA Setting}) - P_{IN}(\text{DSA Setting} = 0) + (\text{DSA Setting})$

Figure 6-56. RX Calibrated Integrated Amplitude Error vs DSA Setting at 2.6 GHz

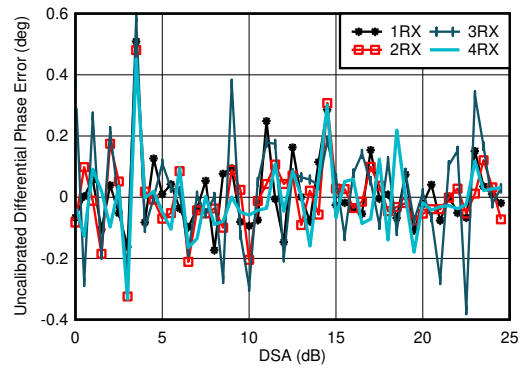

With 0.8 GHz matching
 Differential Phase Error = $\text{Phase}_{IN}(\text{DSA Setting} - 1) - \text{Phase}_{IN}(\text{DSA Setting})$

Figure 6-57. RX Uncalibrated Differential Phase Error vs DSA Setting at 0.8 GHz

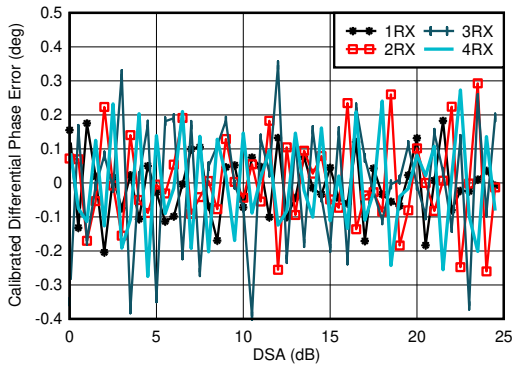

With 0.8 GHz matching
 Differential Phase Error = $\text{Phase}_{IN}(\text{DSA Setting} - 1) - \text{Phase}_{IN}(\text{DSA Setting})$

Figure 6-58. RX Calibrated Differential Phase Error vs DSA Setting at 0.8 GHz

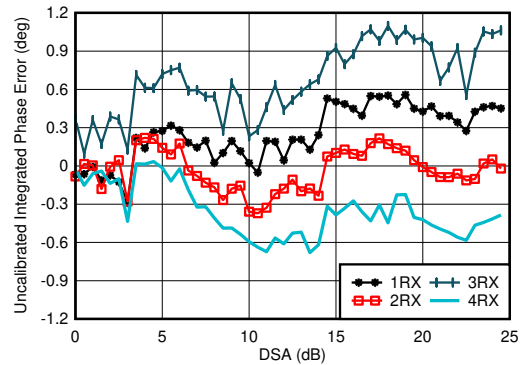

With 0.8 GHz matching
 Integrated Phase Error = $\text{Phase}(\text{DSA Setting}) - \text{Phase}(\text{DSA Setting} = 0)$

Figure 6-59. RX Uncalibrated Integrated Phase Error vs DSA Setting at 0.8 GHz

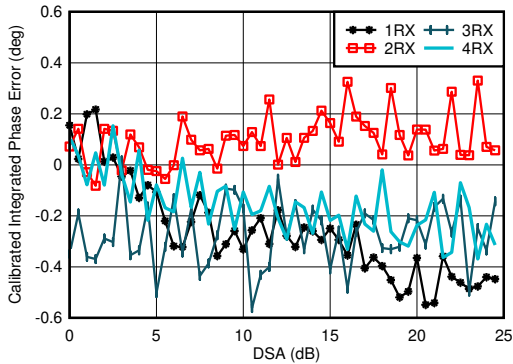

With 0.8 GHz matching
 Integrated Phase Error = $\text{Phase}(\text{DSA Setting}) - \text{Phase}(\text{DSA Setting} = 0)$

Figure 6-60. RX Calibrated Integrated Phase Error vs DSA Setting at 0.8 GHz

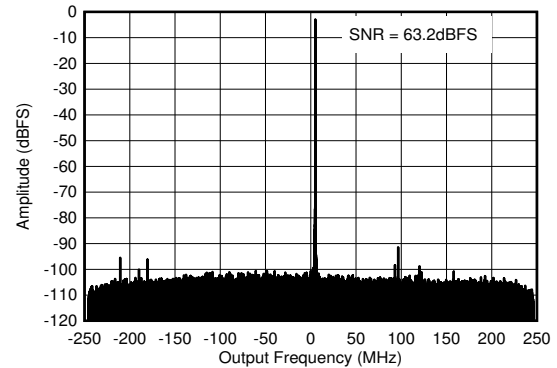

With 0.8 GHz matching, $f_{IN} = 840\text{ MHz}$, $A_{IN} = -3\text{ dBFS}$

Figure 6-61. RX Output FFT at 0.8 GHz

6.11.2 RX Typical Characteristics at 800MHz (continued)

Typical values at $T_A = +25^\circ\text{C}$, ADC Sampling Rate = 2949.12 GHz. Default conditions: output sample rate = 491.52MSPS (decimate by 6), PLL clock mode with $f_{REF} = 491.52\text{MHz}$, $A_{IN} = -3\text{ dBFS}$, DSA setting = 4 dB.

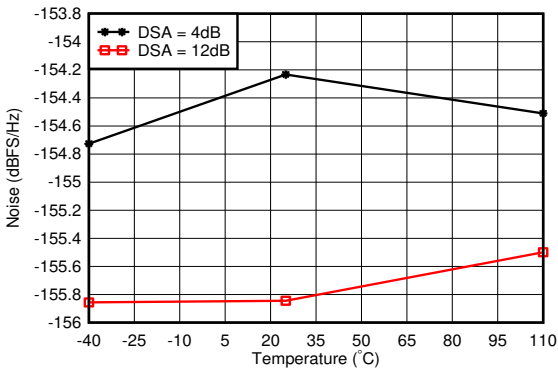

With 0.8 GHz matching, 12.5-MHz offset from tone

Figure 6-62. RX Noise Spectral Density vs Temperature at 0.8 GHz

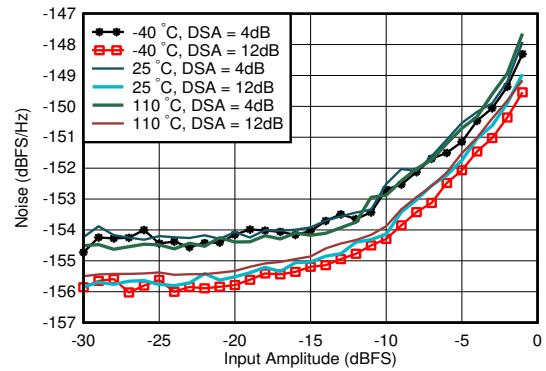

With 0.8 GHz matching, DSA Setting = 12 dB, 12.5-MHz offset from tone

Figure 6-63. RX Noise Spectral Density vs Input Amplitude and Temperature at 0.8 GHz

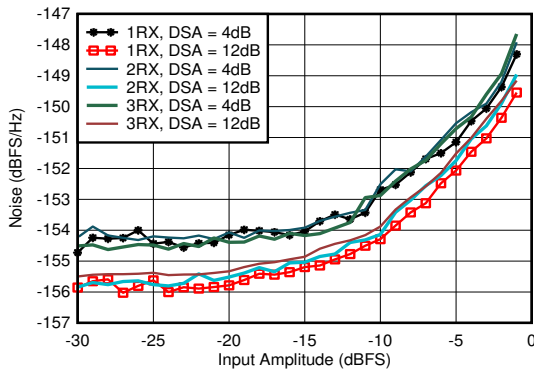

With 0.8 GHz matching, 12.5-MHz offset from tone

Figure 6-64. RX Noise Spectral Density vs Input Amplitude and Channel at 0.8 GHz

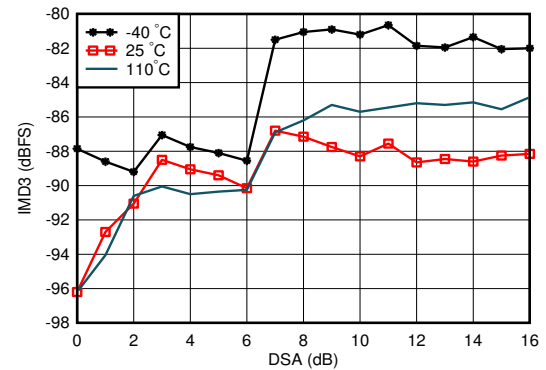

A. With 0.8 GHz matching, each tone -7 dBFS , tone spacing = 20 MHz

Figure 6-65. RX IMD3 vs DSA Setting and Temperature at 0.8 GHz

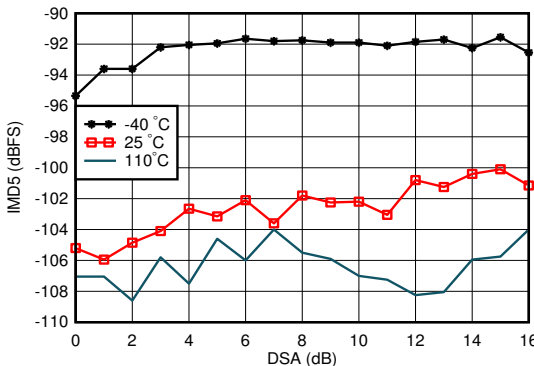

With 0.8 GHz matching, each tone -7 dBFS , tone spacing = 20 MHz

Figure 6-66. RX IMD5 vs DSA Setting and Temperature at 0.8 GHz

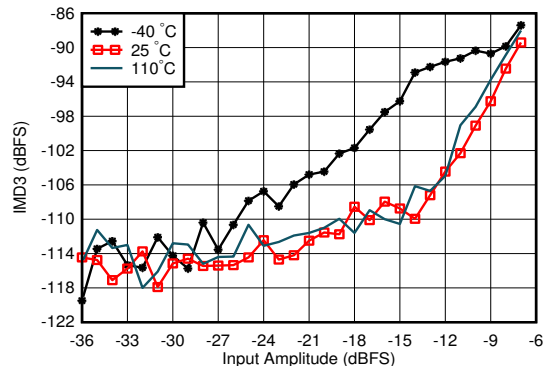

With 0.8 GHz matching, tone spacing = 20 MHz, DSA = 4 dB

Figure 6-67. RX IMD3 vs Input Level and Temperature at 0.8 GHz

6.11.2 RX Typical Characteristics at 800MHz (continued)

Typical values at $T_A = +25^\circ\text{C}$, ADC Sampling Rate = 2949.12 GHz. Default conditions: output sample rate = 491.52MSPS (decimate by 6), PLL clock mode with $f_{REF} = 491.52\text{MHz}$, $A_{IN} = -3\text{dBFS}$, DSA setting = 4 dB.

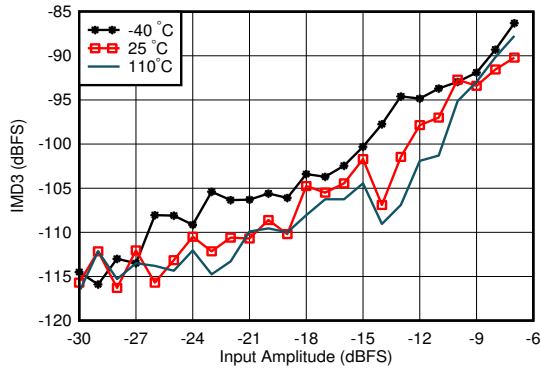

With 0.8 GHz matching, tone spacing = 20 MHz, DSA = 12 dB

Figure 6-68. RX IMD3 vs Input Level and Temperature at 0.8 GHz

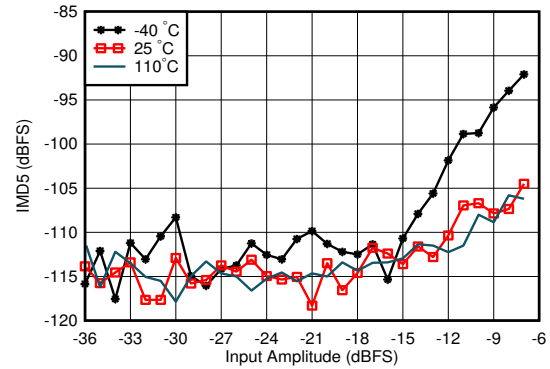

With 0.8 GHz matching, tone spacing = 20 MHz, DSA = 12 dB

Figure 6-69. RX IMD5 vs Input Level and Temperature at 0.8 GHz

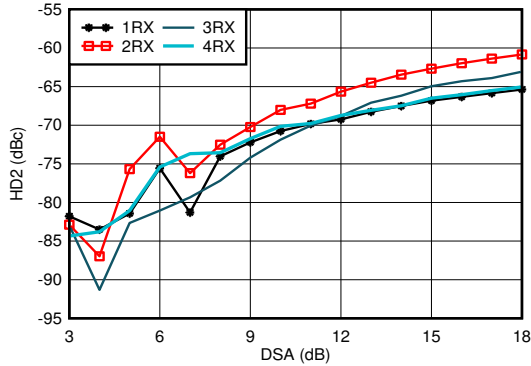

With 0.8 GHz matching, measured after HD2 trim, DDC bypass mode (TI only mode for characterization)

Figure 6-70. RX HD2 vs DSA Setting and Channel at 0.8 GHz

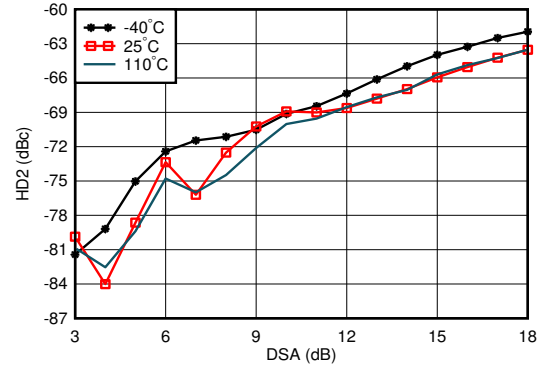

With 0.8 GHz matching, measured after HD2 trim, DDC bypass mode (TI only mode for characterization)

Figure 6-71. RX HD2 vs DSA Setting and Temperature at 0.8 GHz

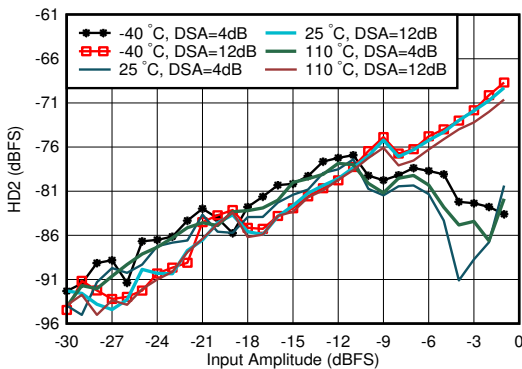

With 0.8 GHz matching, measured after HD2 trim, DDC bypass mode (TI only mode for characterization)

Figure 6-72. RX HD2 vs Input Level and Temperature at 0.8 GHz

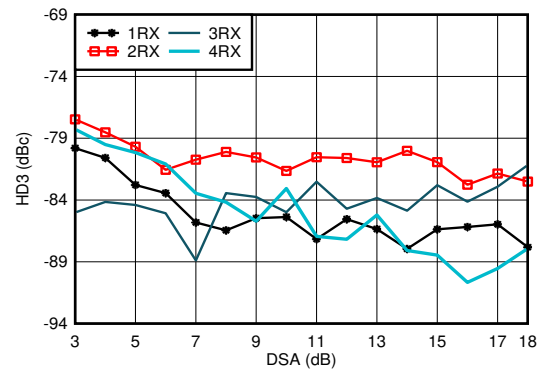

With 0.8 GHz matching, DDC bypass mode (TI only mode for characterization)

Figure 6-73. RX HD3 vs DSA Setting and Channel at 0.8 GHz

6.11.2 RX Typical Characteristics at 800MHz (continued)

Typical values at $T_A = +25^\circ\text{C}$, ADC Sampling Rate = 2949.12 GHz. Default conditions: output sample rate = 491.52MSPS (decimate by 6), PLL clock mode with $f_{REF} = 491.52\text{MHz}$, $A_{IN} = -3\text{ dBFS}$, DSA setting = 4 dB.

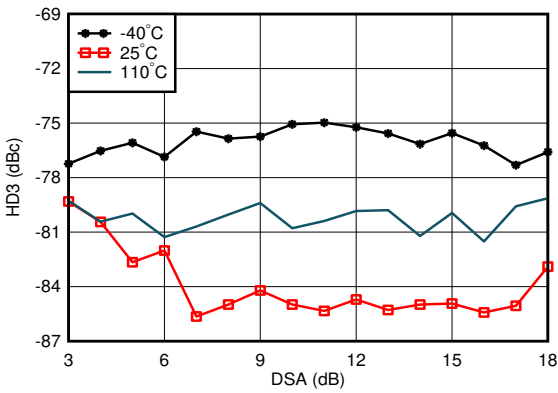

With 0.8 GHz matching, DDC bypass mode (TI only mode for characterization)

Figure 6-74. RX HD3 vs DSA Setting and Temperature at 0.8 GHz

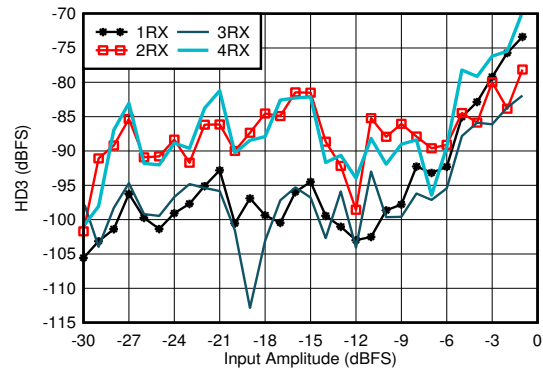

With 0.8 GHz matching, DDC bypass mode (TI only mode for characterization)

Figure 6-75. RX HD3 vs Input Level and Channel at 0.8 GHz

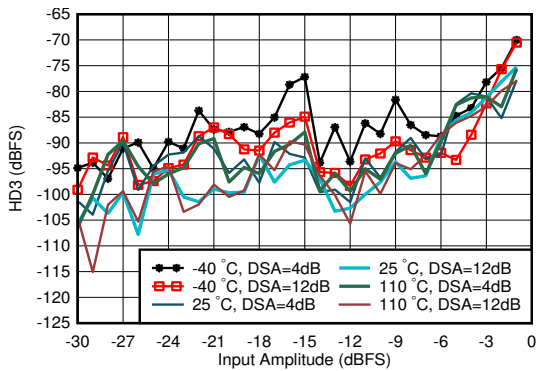

With 0.8 GHz matching, DDC bypass mode (TI only mode for characterization)

Figure 6-76. RX HD3 vs Input Level and Temperature at 0.8 GHz

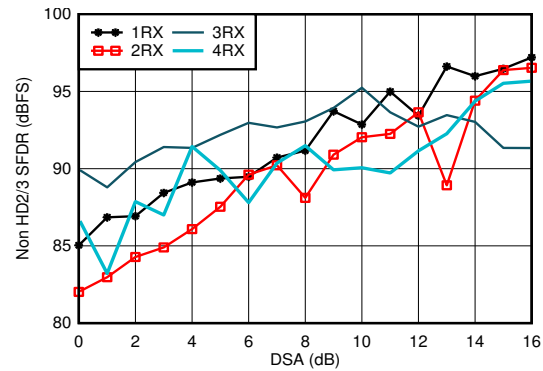

With 0.8 GHz matching

Figure 6-77. RX Non-HD2/3 vs DSA Setting at 0.8 GHz

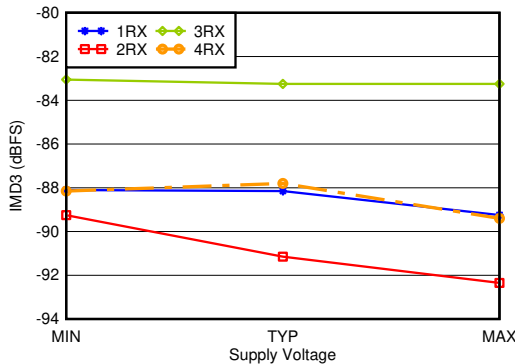

With 0.8 GHz matching, -7 dBFS each tone, 20-MHz tone spacing, all supplies at MIN, TYP, or MAX recommended operating voltages

Figure 6-78. RX IMD3 vs Supply and Channel at 0.8 GHz

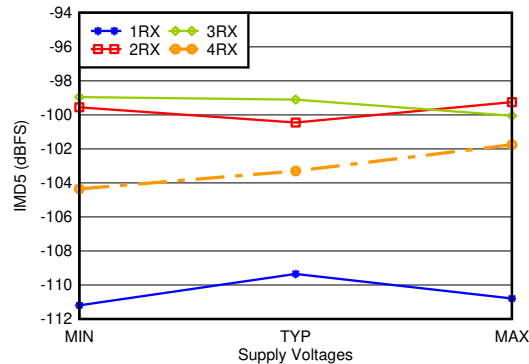

With 0.8 GHz matching, -7 dBFS each tone, 20-MHz tone spacing, all supplies at MIN, TYP, or MAX recommended operating voltages

Figure 6-79. RX IMD5 vs Supply and Channel at 0.8 GHz

6.11.2 RX Typical Characteristics at 800MHz (continued)

Typical values at $T_A = +25^\circ\text{C}$, ADC Sampling Rate = 2949.12 GHz. Default conditions: output sample rate = 491.52MSPS (decimate by 6), PLL clock mode with $f_{REF} = 491.52\text{MHz}$, $A_{IN} = -3 \text{ dBFS}$, DSA setting = 4 dB.

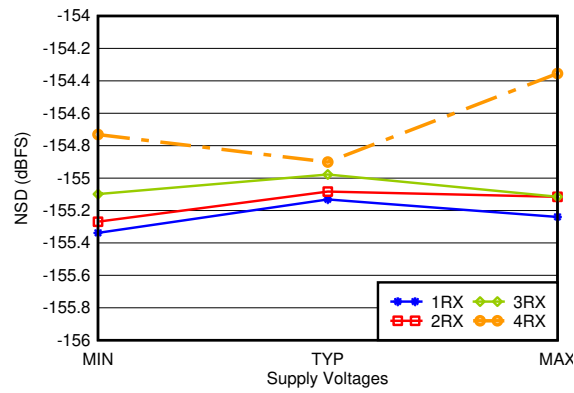

With 0.8 GHz matching, 12.5-MHz offset, all supplies at MIN, TYP, or MAX recommended operating voltages

Figure 6-80. RX Noise Spectral Density vs Supply and Channel at 0.8 GHz

6.11.3 RX Typical Characteristics 1.75GHz to 1.9GHz

Typical values at $T_A = +25^\circ\text{C}$, ADC Sampling Rate = 2949.12 MHz. Default conditions: output sample rate = 491.52MSPS (decimate by 6), PLL clock mode with $f_{REF} = 491.52\text{MHz}$, $A_{IN} = -3\text{ dBFS}$, DSA setting = 4 dB.

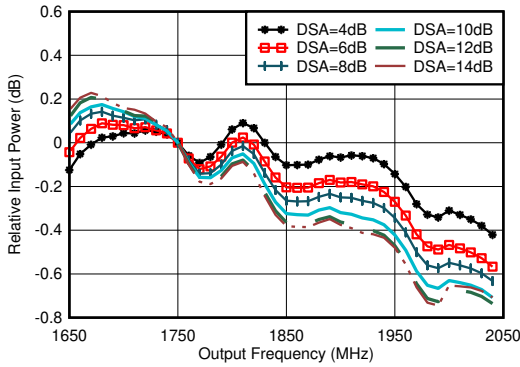

With 1.8 GHz matching, normalized to 1.75 GHz

Figure 6-81. RX In-Band Gain Flatness, $f_{IN} = 1750\text{ MHz}$

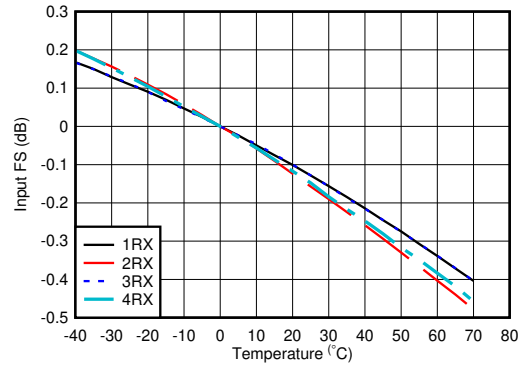

With 1.8 GHz matching, normalized to fullscale at 25°C for each channel

Figure 6-82. RX Input Fullscale vs Temperature and Channel at 1.75 GHz

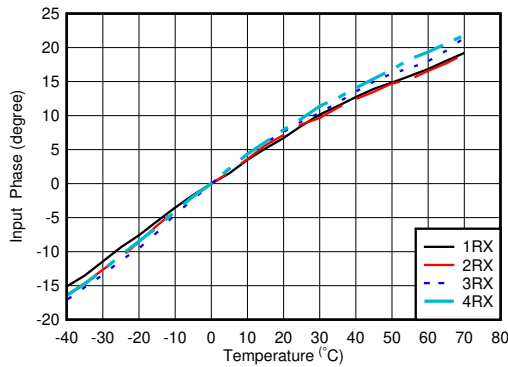

With 2.6 GHz matching, normalized to phase at 25°C

Figure 6-83. RX Input Phase vs Temperature and DSA at $f_{IN} = 1.75\text{ GHz}$

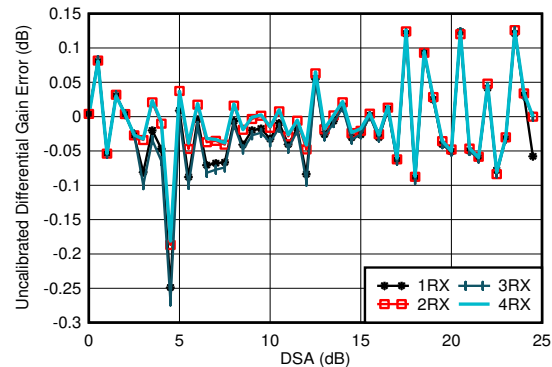

With 1.8 GHz matching

Differential Amplitude Error = $P_{IN}(\text{DSA Setting} - 1) - P_{IN}(\text{DSA Setting}) + 1$

Figure 6-84. RX Uncalibrated Differential Amplitude Error vs DSA Setting at 1.75 GHz

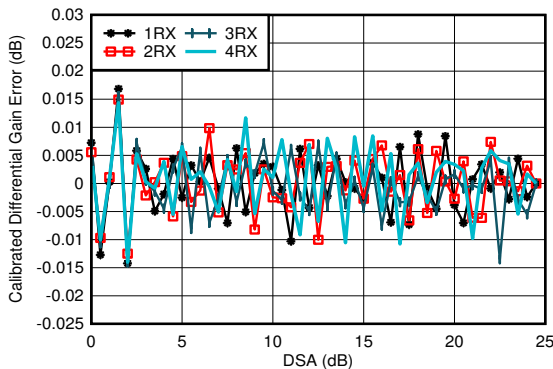

With 1.8 GHz matching

Differential Amplitude Error = $P_{IN}(\text{DSA Setting} - 1) - P_{IN}(\text{DSA Setting}) + 1$

Figure 6-85. RX Calibrated Differential Amplitude Error vs DSA Setting at 1.75 GHz

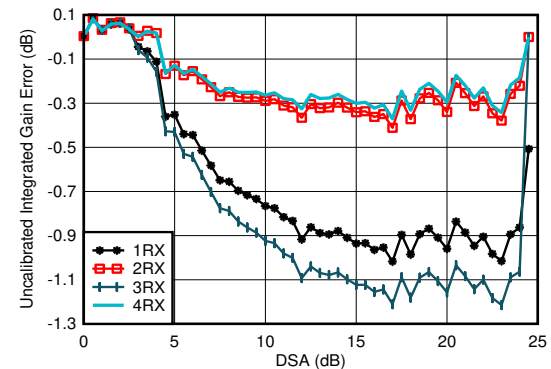

With 1.8 GHz matching

Integrated Amplitude Error = $P_{IN}(\text{DSA Setting}) - P_{IN}(\text{DSA Setting} = 0) + (\text{DSA Setting})$

Figure 6-86. RX Uncalibrated Integrated Amplitude Error vs DSA Setting at 1.75 GHz

6.11.3 RX Typical Characteristics 1.75GHz to 1.9GHz (continued)

Typical values at $T_A = +25^\circ\text{C}$, ADC Sampling Rate = 2949.12 MHz. Default conditions: output sample rate = 491.52MSPS (decimate by 6), PLL clock mode with $f_{REF} = 491.52\text{MHz}$, $A_{IN} = -3\text{dBFS}$, DSA setting = 4 dB.

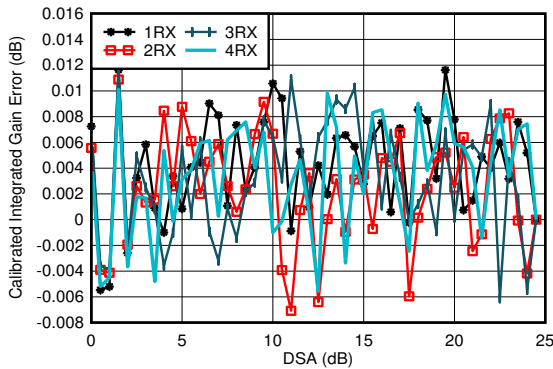

With 1.8 GHz matching
 Integrated Amplitude Error = $P_{IN}(\text{DSA Setting}) - P_{IN}(\text{DSA Setting} = 0) + (\text{DSA Setting})$

Figure 6-87. RX Calibrated Integrated Amplitude Error vs DSA Setting at 1.75 GHz

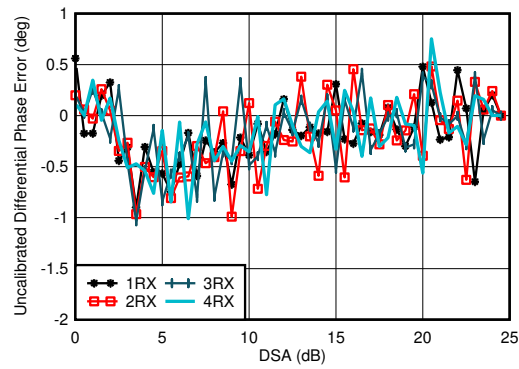

With 1.8 GHz matching
 Differential Phase Error = $\text{Phase}_{IN}(\text{DSA Setting} - 1) - \text{Phase}_{IN}(\text{DSA Setting})$

Figure 6-88. RX Uncalibrated Differential Phase Error vs DSA Setting at 1.75 GHz

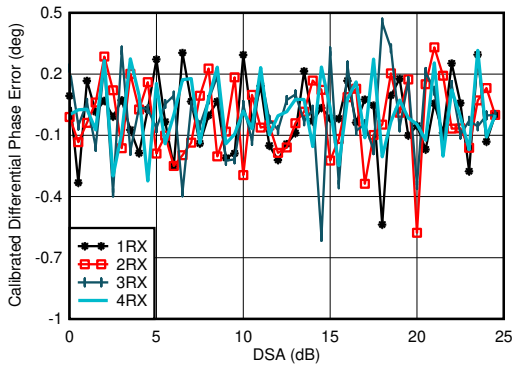

With 1.8 GHz matching
 Differential Phase Error = $\text{Phase}_{IN}(\text{DSA Setting} - 1) - \text{Phase}_{IN}(\text{DSA Setting})$

Figure 6-89. RX Calibrated Differential Phase Error vs DSA Setting at 1.75 GHz

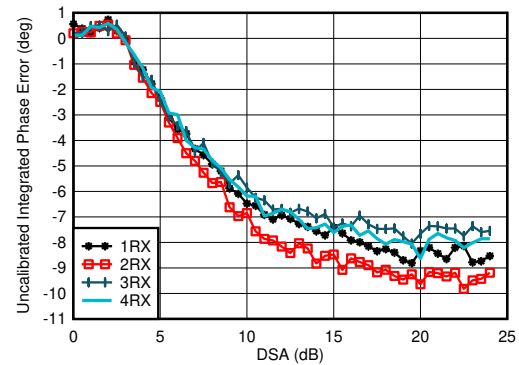

With 1.8 GHz matching
 Integrated Phase Error = $\text{Phase}(\text{DSA Setting}) - \text{Phase}(\text{DSA Setting} = 0)$

Figure 6-90. RX Uncalibrated Integrated Phase Error vs DSA Setting at 1.75 GHz

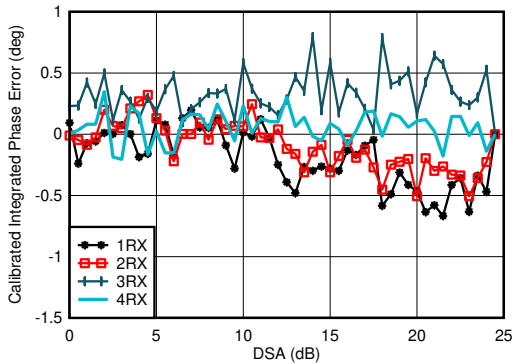

With 1.8 GHz matching
 Integrated Phase Error = $\text{Phase}(\text{DSA Setting}) - \text{Phase}(\text{DSA Setting} = 0)$

Figure 6-91. RX Calibrated Integrated Phase Error vs DSA Setting at 1.75 GHz

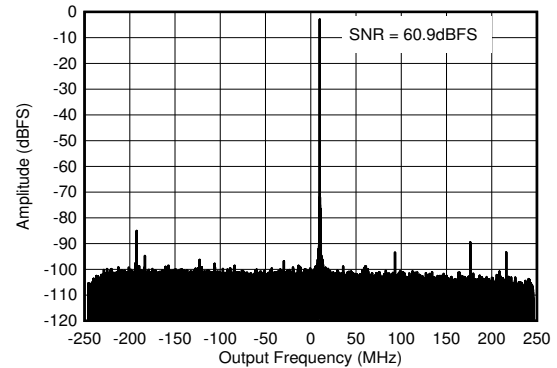

With 1.8 GHz matching, $f_{IN} = 2610\text{MHz}$, $A_{IN} = -3\text{dBFS}$

Figure 6-92. RX Output FFT at 1.75 GHz

6.11.3 RX Typical Characteristics 1.75GHz to 1.9GHz (continued)

Typical values at $T_A = +25^\circ\text{C}$, ADC Sampling Rate = 2949.12 GHz. Default conditions: output sample rate = 491.52MSPS (decimate by 6), PLL clock mode with $f_{REF} = 491.52\text{MHz}$, $A_{IN} = -3\text{ dBFS}$, DSA setting = 4 dB.

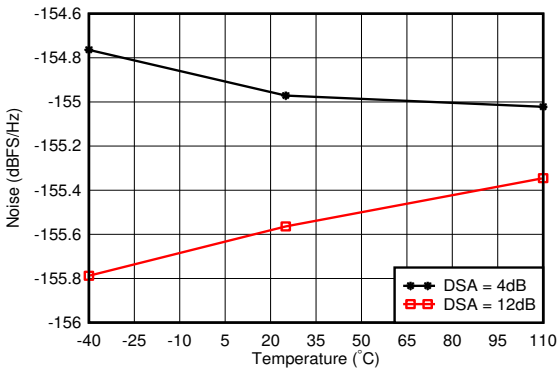

With 1.8 GHz matching, 12.5-MHz offset from tone

Figure 6-93. RX Noise Spectral Density vs Temperature at 1.75 GHz

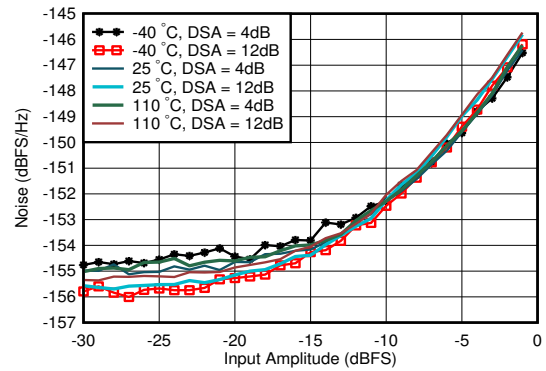

With 1.8 GHz matching, DSA Setting = 12 dB, 12.5-MHz offset from tone

Figure 6-94. RX Noise Spectral Density vs Input Amplitude and Temperature at 1.75 GHz

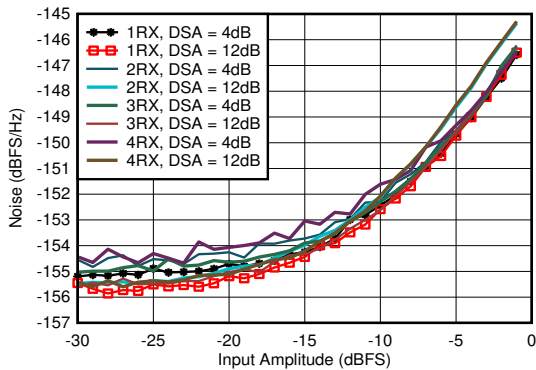

With 1.8 GHz matching, 12.5-MHz offset from tone

Figure 6-95. RX Noise Spectral Density vs Input Amplitude and Channel at 1.75 GHz

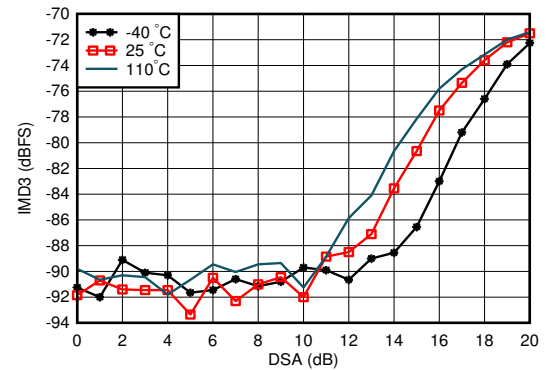

With 1.8 GHz matching, each tone -7 dBFS , tone spacing = 20 MHz

Figure 6-96. RX IMD3 vs DSA Setting and Temperature at 1.75 GHz

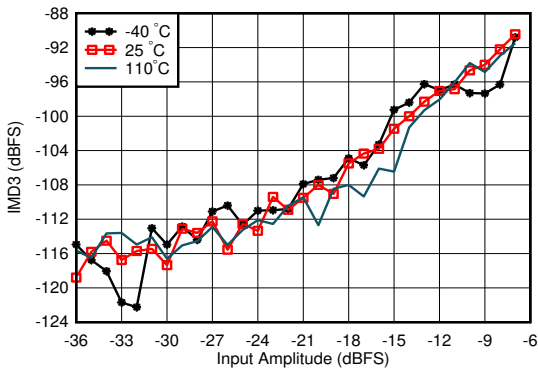

With 1.8 GHz matching, tone spacing = 20 MHz, DSA = 4 dB

Figure 6-97. RX IMD3 vs Input Level and Temperature at 1.75 GHz

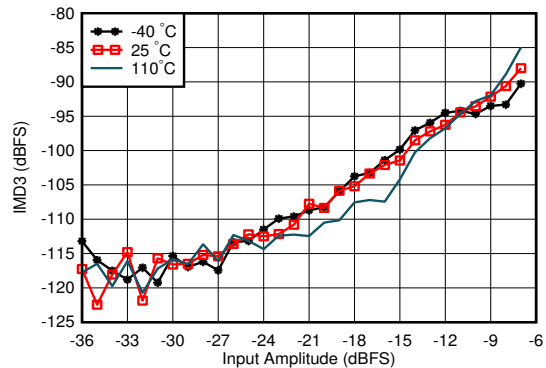

With 1.8 GHz matching, tone spacing = 20 MHz, DSA = 12 dB

Figure 6-98. RX IMD3 vs Input Level and Temperature at 1.75 GHz

6.11.3 RX Typical Characteristics 1.75GHz to 1.9GHz (continued)

Typical values at $T_A = +25^\circ\text{C}$, ADC Sampling Rate = 2949.12 GHz. Default conditions: output sample rate = 491.52MSPS (decimate by 6), PLL clock mode with $f_{REF} = 491.52\text{MHz}$, $A_{IN} = -3\text{dBFS}$, DSA setting = 4 dB.

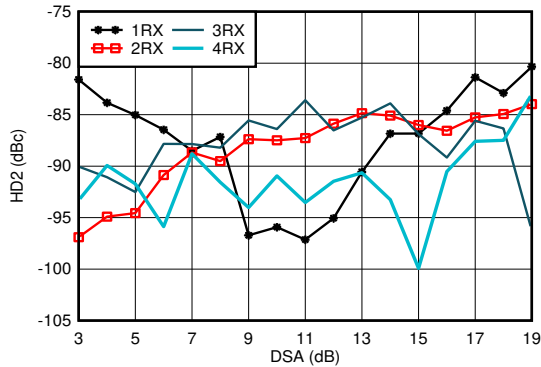

With 1.8 GHz matching, $f_{in} = 1900\text{MHz}$, measured after HD2 trim, DDC bypass mode (TI only mode for characterization)

Figure 6-99. RX HD2 vs DSA Setting and Channel at 1.9 GHz

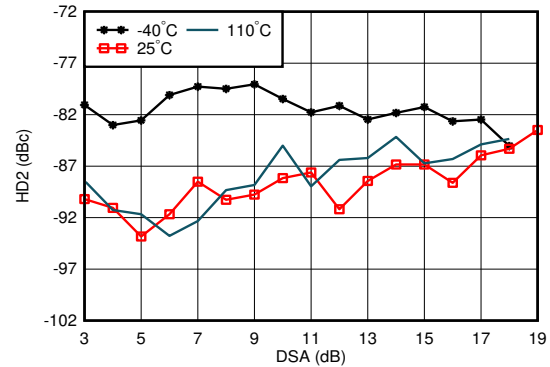

With 1.8 GHz matching, $f_{in} = 1900\text{MHz}$, measured after HD2 trim, DDC bypass mode (TI only mode for characterization)

Figure 6-100. RX HD2 vs DSA Setting and Temperature at 1.9 GHz

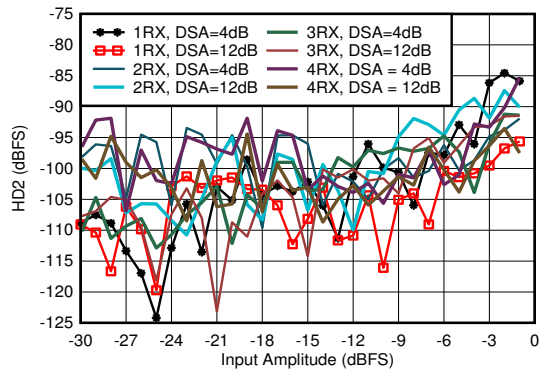

With 1.8 GHz matching, $f_{in} = 1900\text{MHz}$, measured after HD2 trim, DDC bypass mode (TI only mode for characterization)

Figure 6-101. RX HD2 vs Input Amplitude and Channel at 1.9 GHz

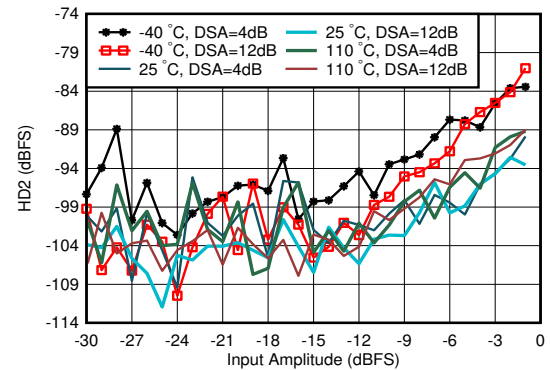

With 1.8 GHz matching, $f_{in} = 1900\text{MHz}$, measured after HD2 trim, DDC bypass mode (TI only mode for characterization)

Figure 6-102. RX HD2 vs Input Amplitude and Temperature at 1.9 GHz

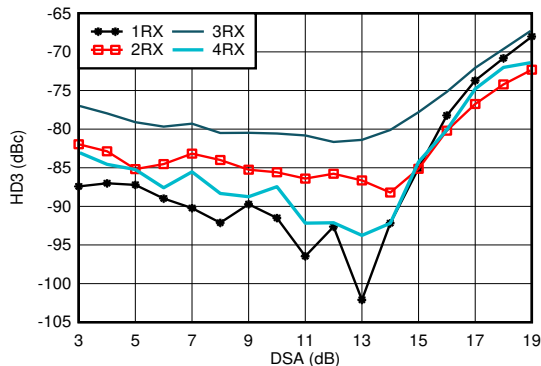

With 1.8 GHz matching, $f_{in} = 1900\text{MHz}$, DDC bypass mode (TI only mode for characterization)

Figure 6-103. RX HD3 vs DSA Setting and Channel at 1.9 GHz

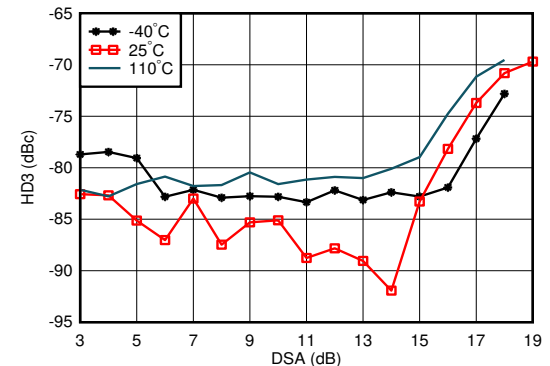

With 1.8 GHz matching, $f_{in} = 1900\text{MHz}$, DDC bypass mode (TI only mode for characterization)

Figure 6-104. RX HD3 vs DSA Setting and Temperature at 1.9 GHz

6.11.3 RX Typical Characteristics 1.75GHz to 1.9GHz (continued)

Typical values at $T_A = +25^\circ\text{C}$, ADC Sampling Rate = 2949.12 GHz. Default conditions: output sample rate = 491.52MSPS (decimate by 6), PLL clock mode with $f_{REF} = 491.52\text{MHz}$, $A_{IN} = -3\text{ dBFS}$, DSA setting = 4 dB.

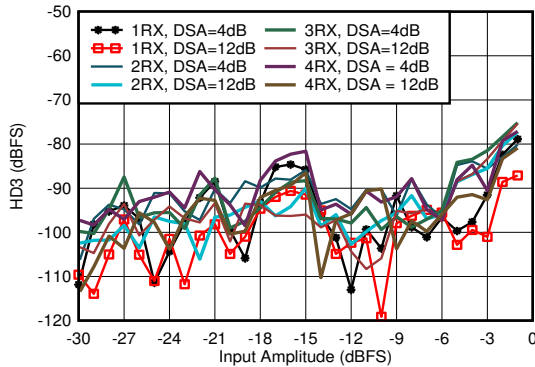

With 1.8 GHz matching, $f_{in} = 1900\text{MHz}$, DDC bypass mode (TI only mode for characterization)

Figure 6-105. RX HD3 vs Input Level and Channel at 1.9 GHz

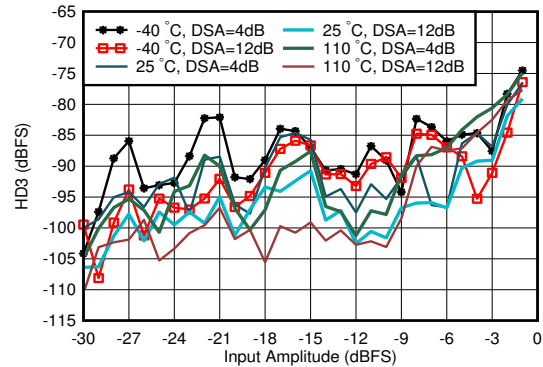

With 1.8 GHz matching, $f_{in} = 1900\text{MHz}$, DDC bypass mode (TI only mode for characterization)

Figure 6-106. RX HD3 vs Input Level and Temperature at 1.9 GHz

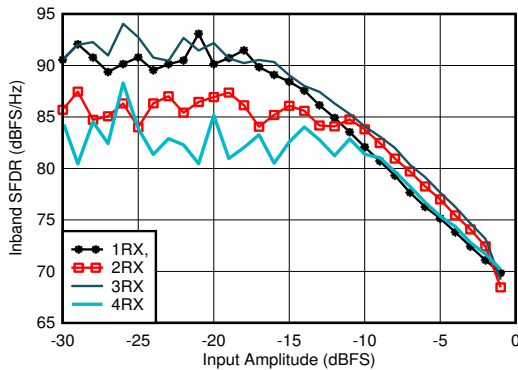

With 1.8 GHz matching, decimated by 3

Figure 6-107. RX In-Band SFDR ($\pm 400\text{ MHz}$) vs Input Amplitude at 1.75 GHz

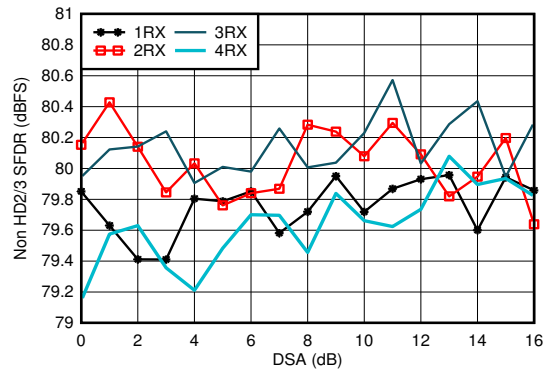

With 1.8 GHz matching

Figure 6-108. RX Non-HD2/3 vs DSA Setting at 1.75 GHz

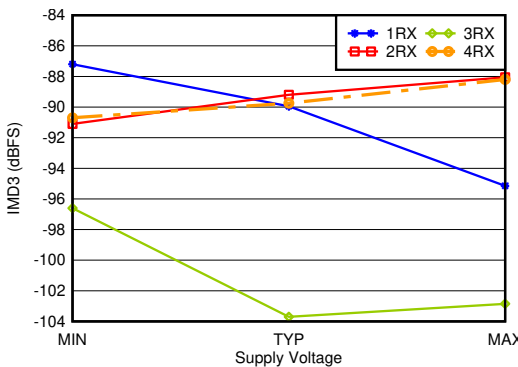

With 1.8 GHz matching, -7 dBFS each tone, 20-MHz tone spacing, all supplies at MIN, TYP, or MAX recommended operating voltages

Figure 6-109. RX IMD3 vs Supply and Channel at 1.75 GHz

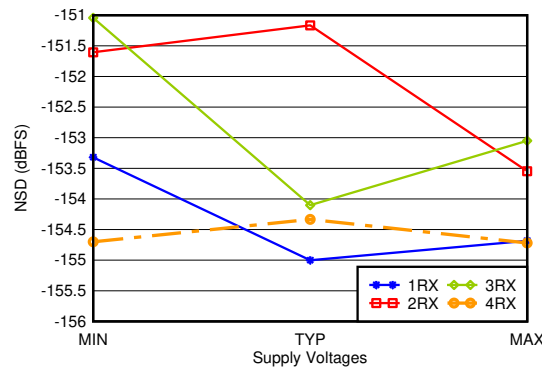

With 1.8 GHz matching, 12.5-MHz offset, all supplies at MIN, TYP, or MAX recommended operating voltages

Figure 6-110. RX Noise Spectral Density vs Supply and Channel at 1.75 GHz

6.11.4 RX Typical Characteristics 2.6GHz

Typical values at $T_A = +25^\circ\text{C}$, ADC Sampling Rate = 2949.12 GHz. Default conditions: output sample rate = 491.52MSPS (decimate by 6), PLL clock mode with $f_{REF} = 491.52\text{MHz}$, $A_{IN} = -3\text{ dBFS}$, DSA setting = 4 dB.

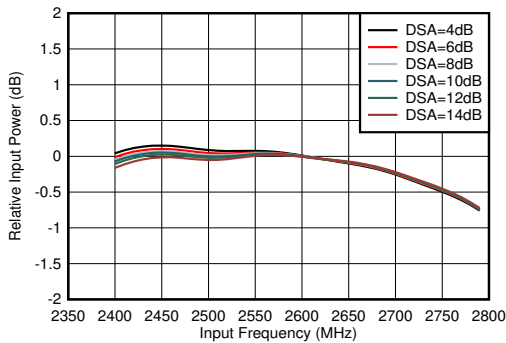

With matching, normalized to power at 2.6 GHz for each DSA setting

Figure 6-111. RX Inband Gain Flatness, $f_{IN} = 2600\text{ MHz}$

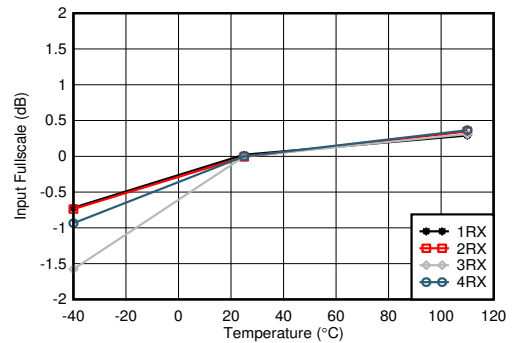

With 2.6 GHz matching, normalized to fullscale at 25°C for each channel

Figure 6-112. RX Input Fullscale vs Temperature and Channel at 2.6 GHz

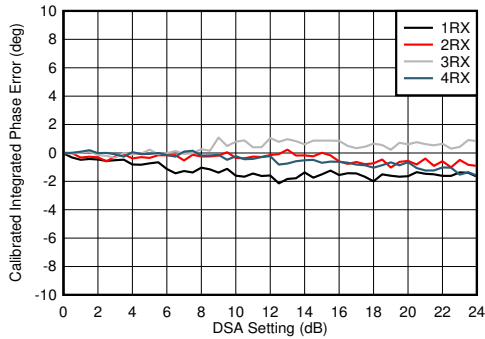

With 2.6 GHz matching
Integrated Phase Error = Phase(DSA Setting) – Phase(DSA Setting = 0)

Figure 6-113. RX Calibrated Integrated Phase Error vs DSA Setting at 2.6 GHz

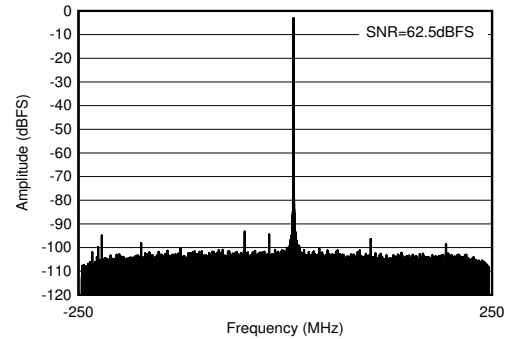

With 2.6 GHz matching, $f_{IN} = 2610\text{ MHz}$, $A_{IN} = -3\text{ dBFS}$

Figure 6-114. RX Output FFT at 2.6 GHz

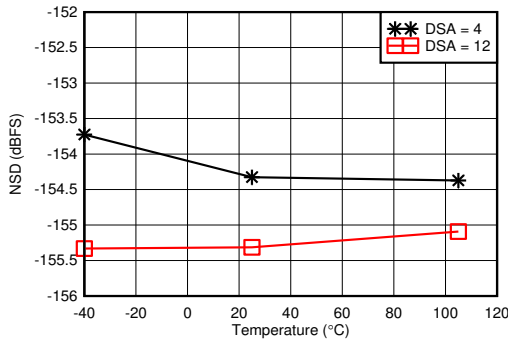

With 2.6 GHz matching, 12.5-MHz offset from tone

Figure 6-115. RX Noise Spectral Density vs Temperature at 2.6 GHz

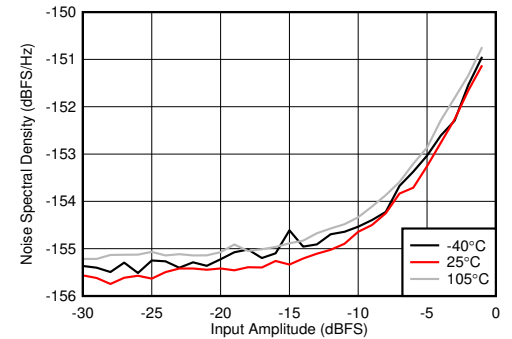

With 2.6 GHz matching, DSA Setting = 12 dB, 12.5-MHz offset from tone

Figure 6-116. RX Noise Spectral Density vs Input Amplitude and Temperature at 2.6 GHz

6.11.4 RX Typical Characteristics 2.6GHz (continued)

Typical values at $T_A = +25^\circ\text{C}$, ADC Sampling Rate = 2949.12 GHz. Default conditions: output sample rate = 491.52MSPS (decimate by 6), PLL clock mode with $f_{REF} = 491.52\text{MHz}$, $A_{IN} = -3\text{ dBFS}$, DSA setting = 4 dB.

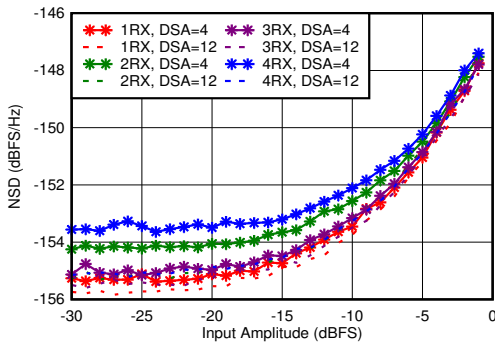

With 2.6 GHz matching, 12.5-MHz offset from tone

Figure 6-117. RX Noise Spectral Density vs Input Amplitude and Channel at 2.6 GHz

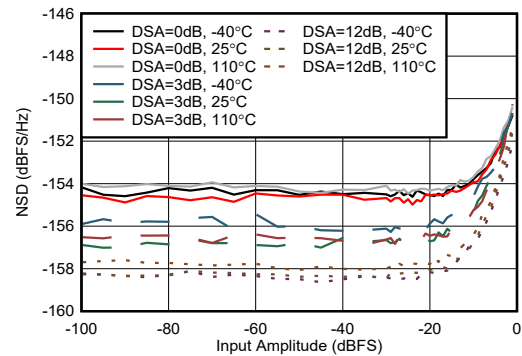

50-MHz offset from tone, external clock mode

Figure 6-118. RX Noise Spectral Density vs Input Amplitude at 2.61 GHz (Ext. Clock)

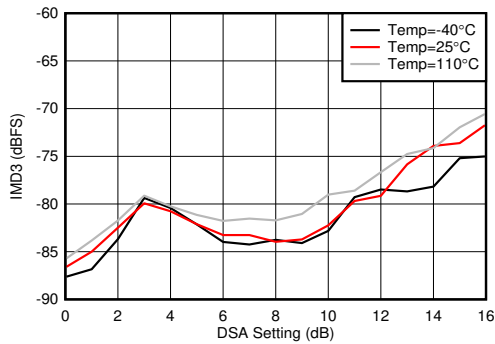

With 2.6 GHz matching, each tone -7 dBFS , tone spacing = 20 MHz

Figure 6-119. RX IMD3 vs DSA Setting and Temperature at 2.6 GHz

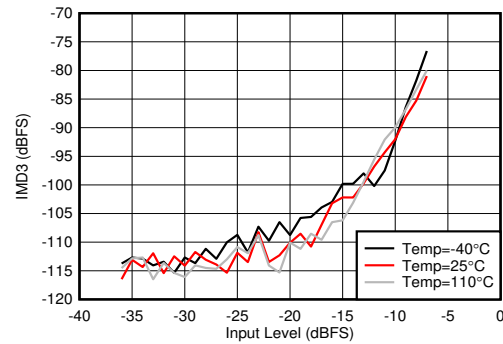

With 2.6 GHz matching, tone spacing = 20 MHz, DSA = 4 dB

Figure 6-120. RX IMD3 vs Input Level and Temperature at 2.6 GHz

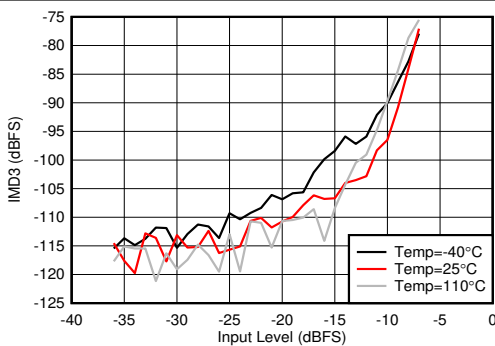

With 2.6 GHz matching, tone spacing = 20 MHz, DSA = 12 dB

Figure 6-121. RX IMD3 vs Input Level and Temperature at 2.6 GHz

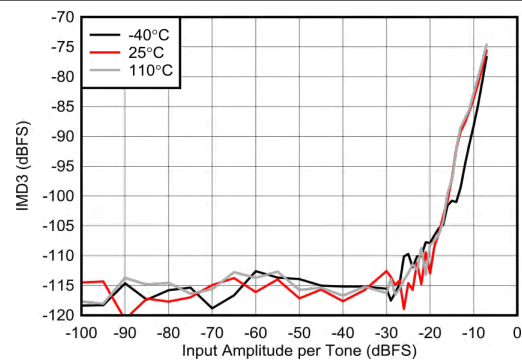

Tone spacing = 50 MHz, External clock mode

Figure 6-122. RX IMD3 vs Input Level at 2.6 GHz (Ext. Clock)

6.11.4 RX Typical Characteristics 2.6GHz (continued)

Typical values at $T_A = +25^\circ\text{C}$, ADC Sampling Rate = 2949.12 MHz. Default conditions: output sample rate = 491.52MSPS (decimate by 6), PLL clock mode with $f_{REF} = 491.52\text{MHz}$, $A_{IN} = -3\text{ dBFS}$, DSA setting = 4 dB.

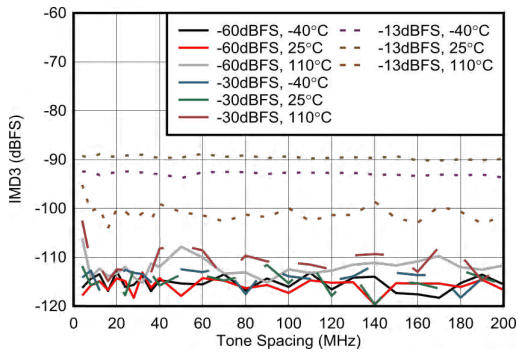

External clock mode

Figure 6-123. RX IMD3 vs Tone Spacing at 2.6 GHz (Ext. Clock)

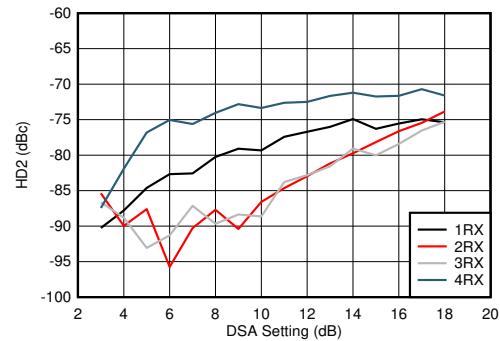

With 2.6 GHz matching, DDC bypass mode (TI only mode for characterization)

Figure 6-124. RX HD2 vs DSA Setting and Channel at 2.6 GHz

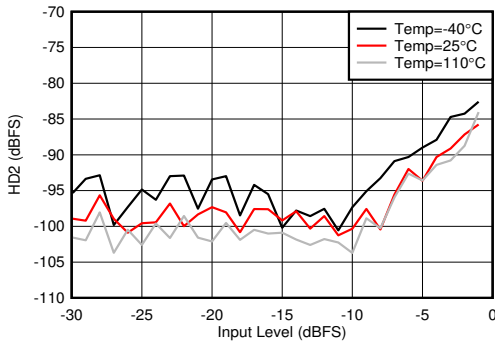

With 2.6 GHz matching, DDC bypass mode (TI only mode for characterization)

Figure 6-125. RX HD2 vs Input Level and Temperature at 2.6 GHz

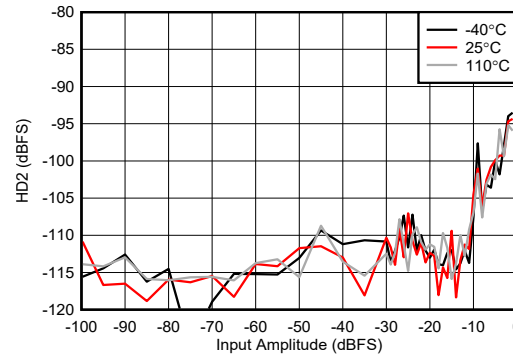

External clock mode

Figure 6-126. RX HD2 vs Input Level and Temperature at 2.6 GHz

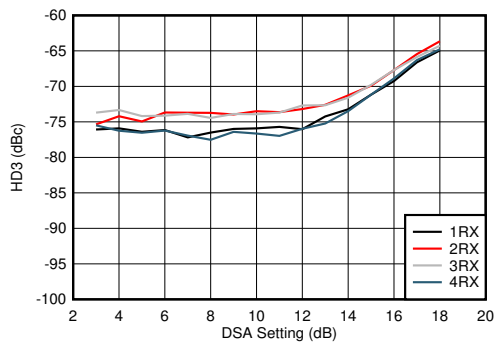

With 2.6 GHz matching, DDC bypass mode (TI only mode for characterization)

Figure 6-127. RX HD3 vs DSA Setting and Channel at 2.6 GHz

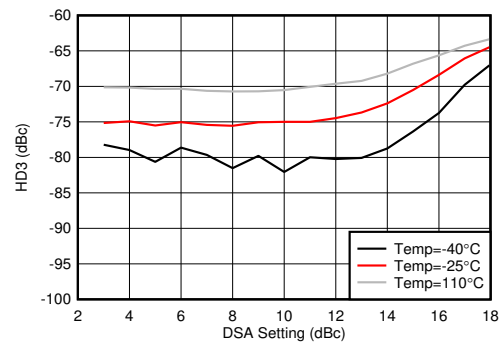

With 2.6 GHz matching, DDC bypass mode (TI only mode for characterization)

Figure 6-128. RX HD3 vs DSA Setting and Temperature at 2.6 GHz

6.11.4 RX Typical Characteristics 2.6GHz (continued)

Typical values at $T_A = +25^\circ\text{C}$, ADC Sampling Rate = 2949.12 MHz. Default conditions: output sample rate = 491.52MSPS (decimate by 6), PLL clock mode with $f_{REF} = 491.52\text{MHz}$, $A_{IN} = -3\text{ dBFS}$, DSA setting = 4 dB.

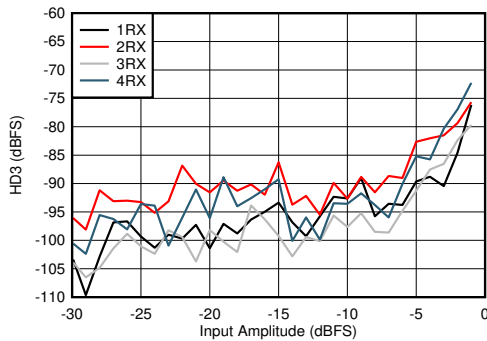

With 2.6 GHz matching, DDC bypass mode (TI only mode for characterization)

Figure 6-129. RX HD3 vs Input Level and Channel at 2.6 GHz

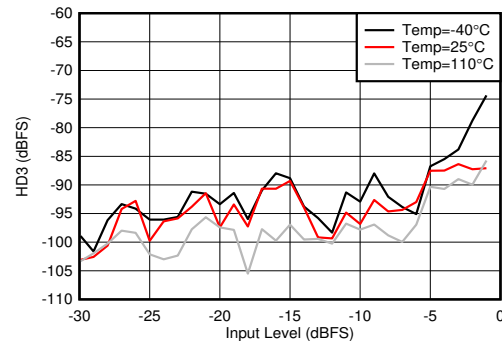

With 2.6 GHz matching, DDC bypass mode (TI only mode for characterization)

Figure 6-130. RX HD3 vs Input Level and Temperature at 2.6 GHz

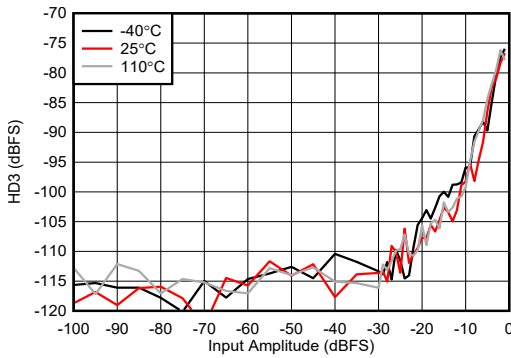

External clock mode

Figure 6-131. RX HD3 vs Input Level and Temperature at 2.6 GHz

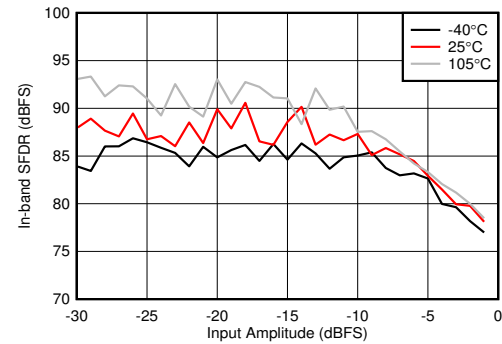

With 2.6 GHz matching, decimate by 4

Figure 6-132. RX In-Band SFDR ($\pm 300\text{ MHz}$) vs Input Amplitude and Temperature at 2.6 GHz

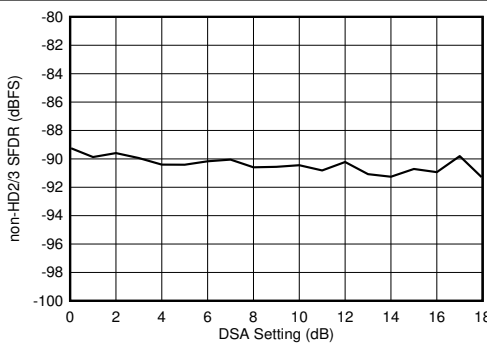

With 2.6 GHz matching

Figure 6-133. RX Non-HD2/3 vs DSA Setting at 2.6 GHz

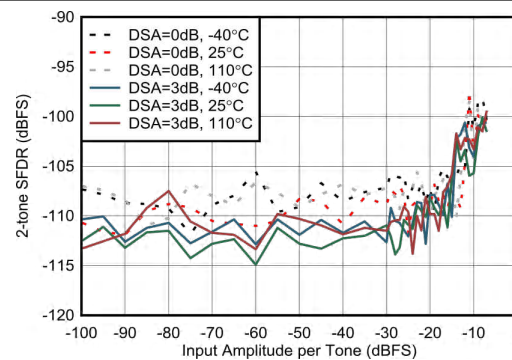

External clock mode, 50MHz tone spacing, excluding 3rd order distortion

Figure 6-134. RX 2-tone SFDR vs Input Amplitude at 2.6 GHz

6.11.4 RX Typical Characteristics 2.6GHz (continued)

Typical values at $T_A = +25^\circ\text{C}$, ADC Sampling Rate = 2949.12 GHz. Default conditions: output sample rate = 491.52MSPS (decimate by 6), PLL clock mode with $f_{REF} = 491.52\text{MHz}$, $A_{IN} = -3 \text{ dBFS}$, DSA setting = 4 dB.

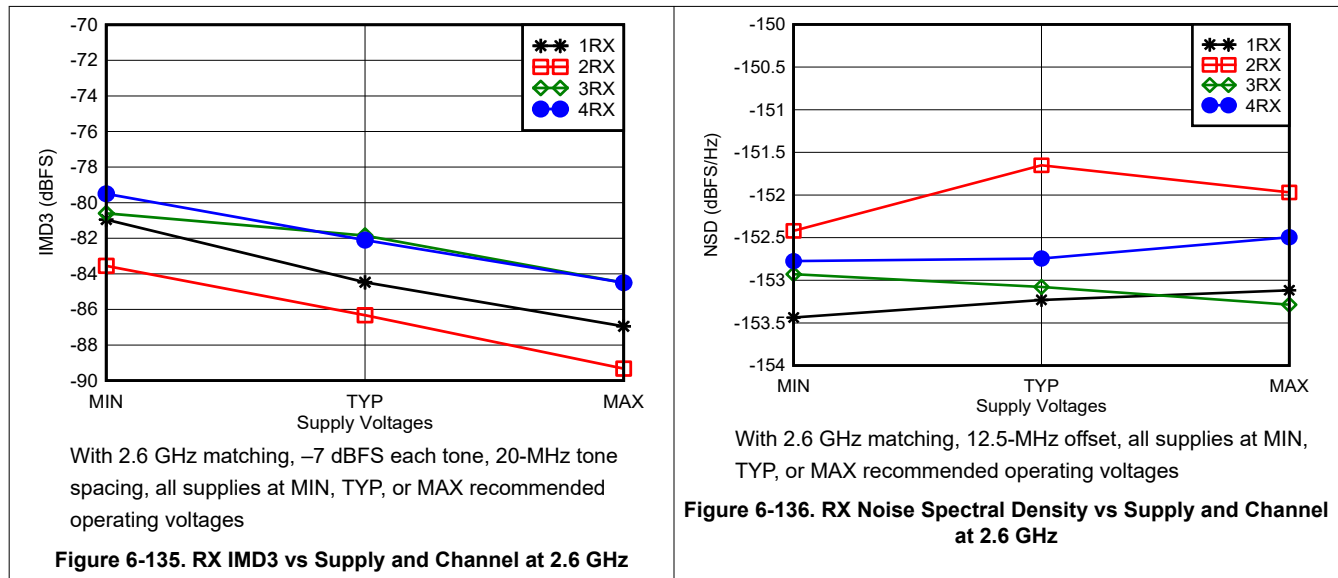

6.11.5 RX Typical Characteristics 3.5GHz

Typical values at $T_A = +25^\circ\text{C}$, ADC Sampling Rate = 2949.12 GHz. Default conditions: output sample rate = 491.52MSPS (decimate by 6), PLL clock mode with $f_{REF} = 491.52\text{MHz}$, $A_{IN} = -3\text{ dBFS}$, DSA setting = 4 dB.

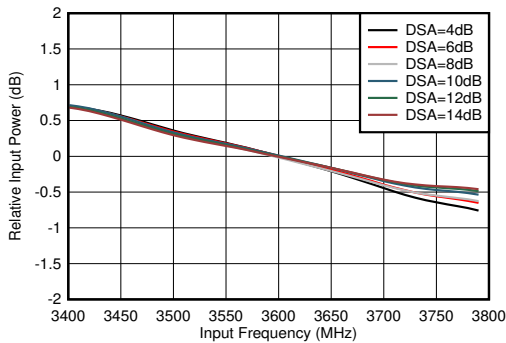

With 3.6 GHz matching, normalized to 3.6 GHz

Figure 6-137. RX In-Band Gain Flatness, $f_{IN} = 3600\text{ MHz}$

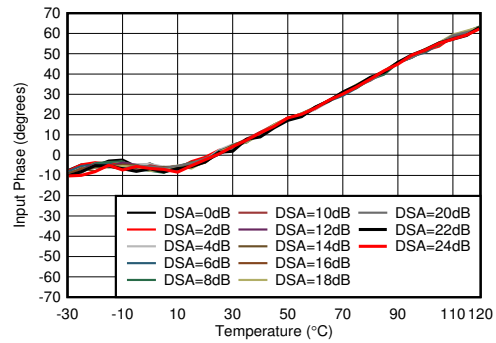

With 3.6 GHz matching, normalized to phase at 25°C

Figure 6-138. RX Input Phase vs Temperature at 3.6 GHz

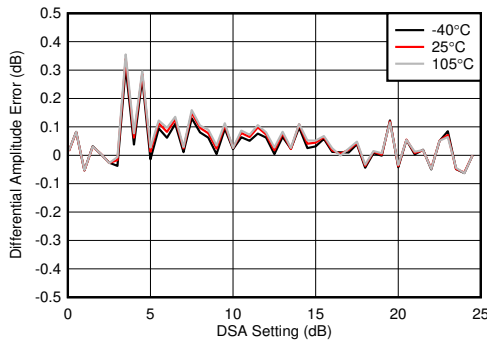

With 3.6 GHz matching

Differential Amplitude Error = $P_{IN}(\text{DSA Setting} - 1) - P_{IN}(\text{DSA Setting}) + 1$

Figure 6-139. RX Uncalibrated Differential Amplitude Error vs DSA Setting at 3.6 GHz

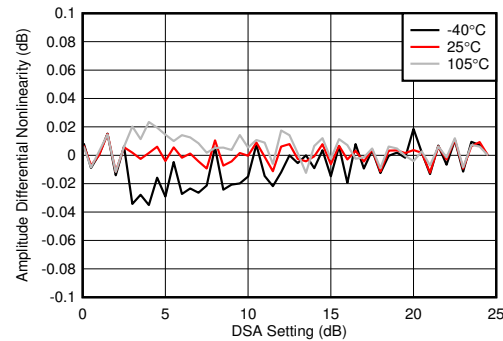

With 3.6 GHz matching

Differential Amplitude Error = $P_{IN}(\text{DSA Setting} - 1) - P_{IN}(\text{DSA Setting}) + 1$

Figure 6-140. RX Calibrated Differential Amplitude Error vs DSA Setting at 3.6 GHz

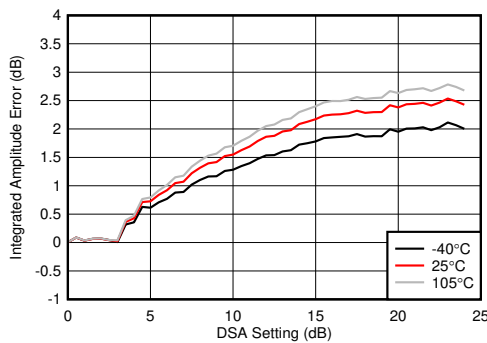

With 3.6 GHz matching

Integrated Amplitude Error = $P_{IN}(\text{DSA Setting}) - P_{IN}(\text{DSA Setting} = 0) + (\text{DSA Setting})$

Figure 6-141. RX Uncalibrated Integrated Amplitude Error vs DSA Setting at 3.6 GHz

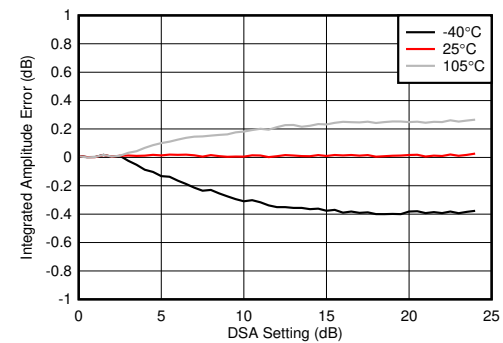

With 3.6 GHz matching

Integrated Amplitude Error = $P_{IN}(\text{DSA Setting}) - P_{IN}(\text{DSA Setting} = 0) + (\text{DSA Setting})$

Figure 6-142. RX Calibrated Integrated Amplitude Error vs DSA Setting at 3.6 GHz

6.11.5 RX Typical Characteristics 3.5GHz (continued)

Typical values at $T_A = +25^\circ\text{C}$, ADC Sampling Rate = 2949.12 MHz. Default conditions: output sample rate = 491.52MSPS (decimate by 6), PLL clock mode with $f_{REF} = 491.52\text{MHz}$, $A_{IN} = -3 \text{ dBFS}$, DSA setting = 4 dB.

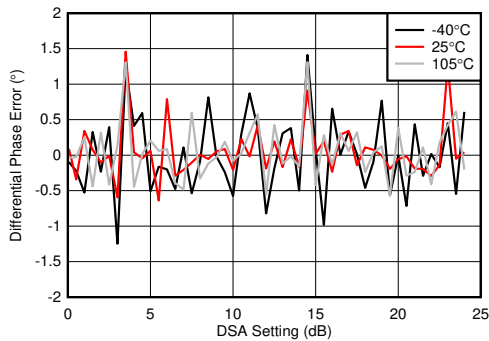

With 3.6 GHz matching
 Differential Phase Error = $\text{Phase}_{IN}(\text{DSA Setting} - 1) - \text{Phase}_{IN}(\text{DSA Setting})$

Figure 6-143. RX Uncalibrated Phase Error vs DSA Setting at 3.6 GHz

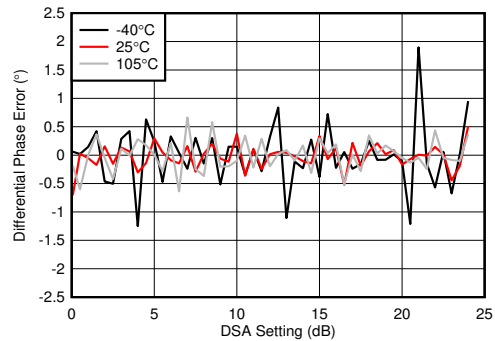

With 3.6 GHz matching
 Differential Phase Error = $\text{Phase}_{IN}(\text{DSA Setting} - 1) - \text{Phase}_{IN}(\text{DSA Setting})$

Figure 6-144. RX Calibrated Differential Phase Error vs DSA Setting at 3.6 GHz

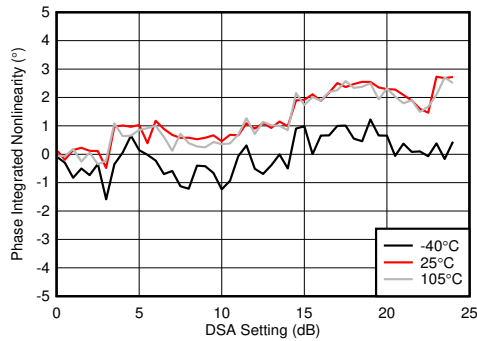

With 3.6 GHz matching
 Integrated Phase Error = $\text{Phase}(\text{DSA Setting}) - \text{Phase}(\text{DSA Setting} = 0)$

Figure 6-145. RX Uncalibrated Integrated Phase Error vs DSA Setting at 3.6 GHz

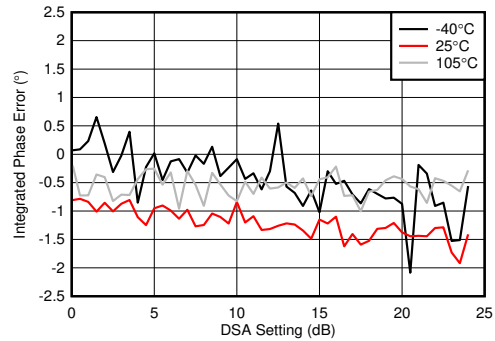

With 3.6 GHz matching
 Integrated Phase Error = $\text{Phase}(\text{DSA Setting}) - \text{Phase}(\text{DSA Setting} = 0)$

Figure 6-146. RX Calibrated Integrated Phase Error vs DSA Setting at 3.6 GHz

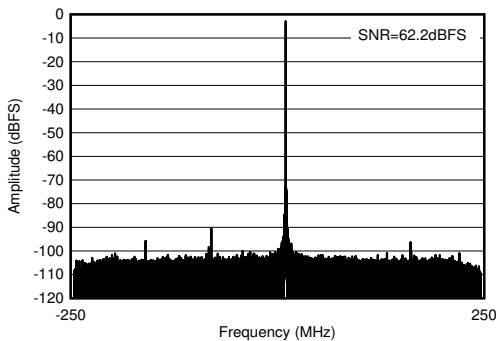

With 3.6 GHz matching, $f_{IN} = 3610 \text{ MHz}$, $A_{IN} = -3 \text{ dBFS}$

Figure 6-147. RX Output FFT at 3.6 GHz

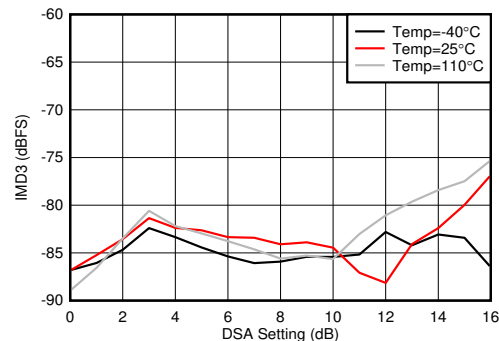

With 3.5 GHz matching, each tone at -7 dBFS , 20-MHz tone spacing

Figure 6-148. RX IMD3 vs DSA Setting and Temperature at 3.6 GHz

6.11.5 RX Typical Characteristics 3.5GHz (continued)

Typical values at $T_A = +25^\circ\text{C}$, ADC Sampling Rate = 2949.12 MHz. Default conditions: output sample rate = 491.52MSPS (decimate by 6), PLL clock mode with $f_{REF} = 491.52\text{MHz}$, $A_{IN} = -3\text{dBFS}$, DSA setting = 4 dB.

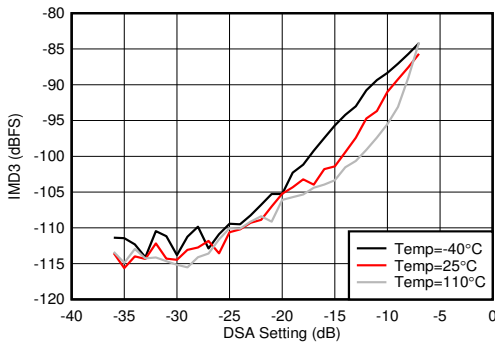

With 3.5 GHz matching, 20-MHz tone spacing

Figure 6-149. RX IMD3 vs Input Level and Temperature at 3.6 GHz

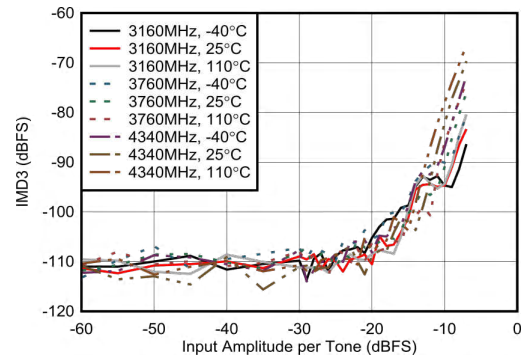

External clock mode, 20-MHz tone spacing, 2x Decimation

Figure 6-150. RX IMD3 vs Input Level

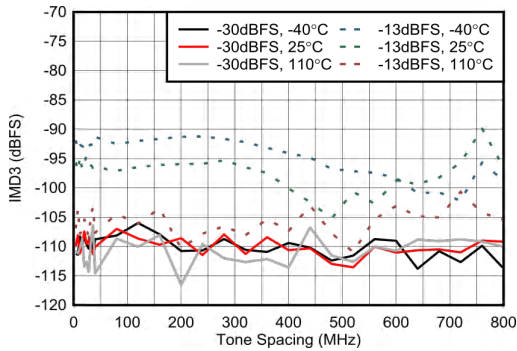

External clock mode, 2x Decimation

Figure 6-151. RX IMD3 vs Tone Spacing at 3.76GHz

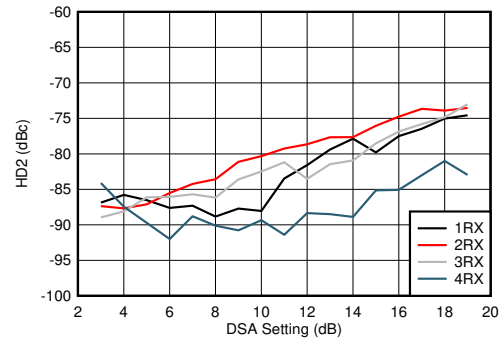

With 3.5 GHz matching, DDC bypass mode (TI only mode for characterization)

Figure 6-152. RX HD2 vs DSA Setting and Channel at 3.6 GHz

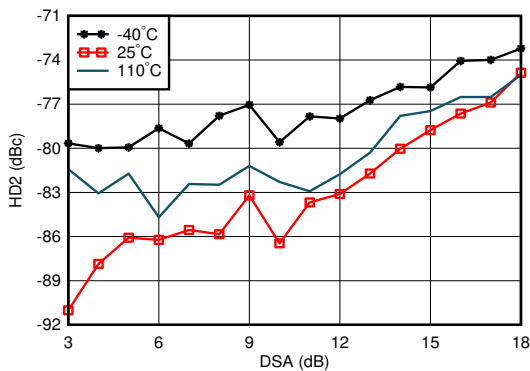

With 3.5 GHz matching, DDC bypass mode (TI only mode for characterization)

Figure 6-153. RX HD2 vs DSA Setting and Temperature at 3.6 GHz

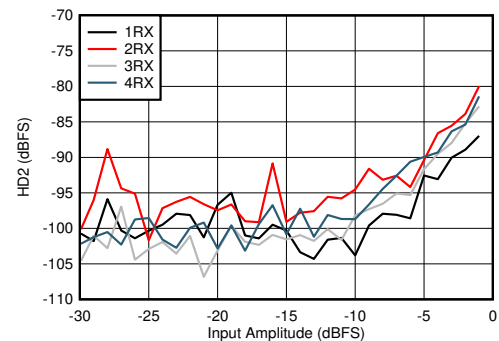

With 3.5 GHz matching, DDC bypass mode (TI only mode for characterization)

Figure 6-154. RX HD2 vs Input Level and Channel at 3.6 GHz

6.11.5 RX Typical Characteristics 3.5GHz (continued)

Typical values at $T_A = +25^\circ\text{C}$, ADC Sampling Rate = 2949.12 MHz. Default conditions: output sample rate = 491.52MSPS (decimate by 6), PLL clock mode with $f_{REF} = 491.52\text{MHz}$, $A_{IN} = -3\text{ dBFS}$, DSA setting = 4 dB.

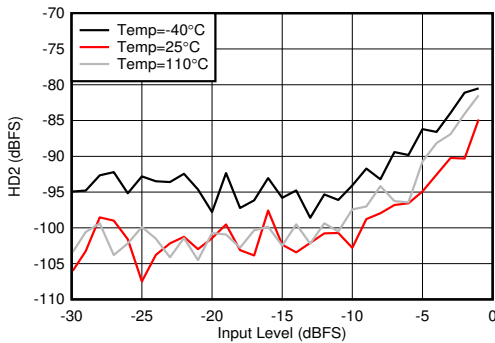

With 3.5 GHz matching, DDC bypass mode (TI only mode for characterization)

Figure 6-155. RX HD2 vs Input Level and Temperature at 3.6 GHz

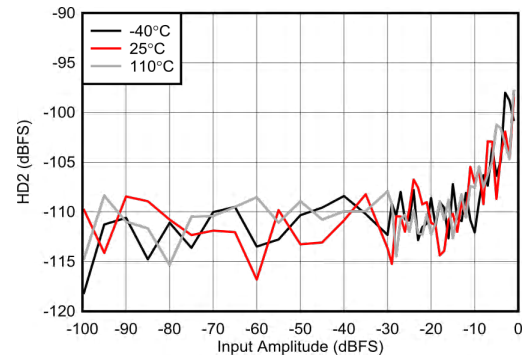

External clock mode, 2x Decimation

Figure 6-156. RX HD2 vs Input Level at 3.76 GHz

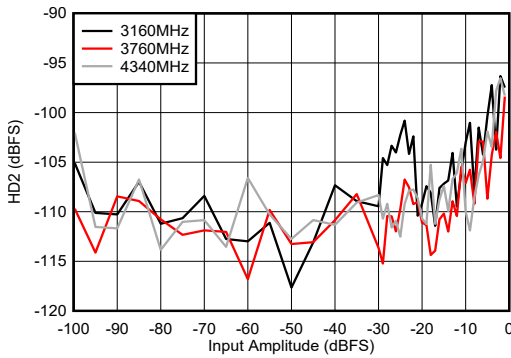

External clock mode, 25°C, 2x Decimation

Figure 6-157. RX HD2 vs Input Level

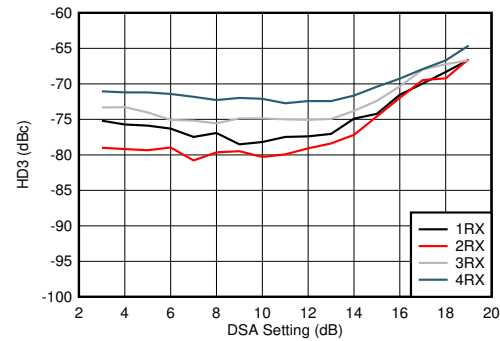

With 3.5 GHz matching, DDC bypass mode (TI only mode for characterization)

Figure 6-158. RX HD3 vs DSA Setting and Channel at 3.6 GHz

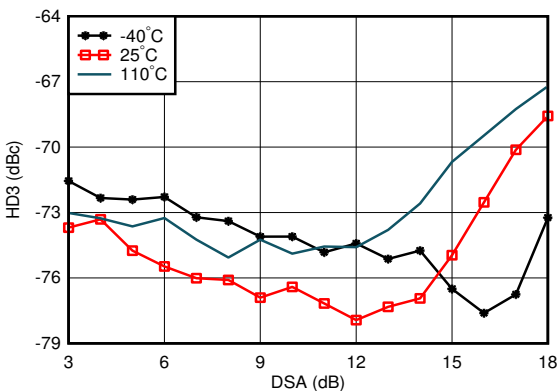

With 3.5 GHz matching, DDC bypass mode (TI only mode for characterization)

Figure 6-159. RX HD3 vs DSA Setting and Temperature at 3.6 GHz

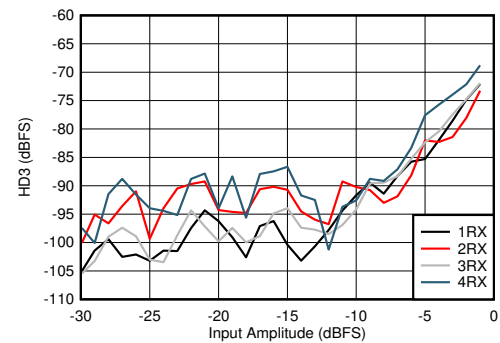

With 3.5 GHz matching, DDC bypass mode (TI only mode for characterization)

Figure 6-160. RX HD3 vs Input Level and Channel at 3.6 GHz

6.11.5 RX Typical Characteristics 3.5GHz (continued)

Typical values at $T_A = +25^\circ\text{C}$, ADC Sampling Rate = 2949.12 MHz. Default conditions: output sample rate = 491.52MSPS (decimate by 6), PLL clock mode with $f_{REF} = 491.52\text{MHz}$, $A_{IN} = -3\text{ dBFS}$, DSA setting = 4 dB.

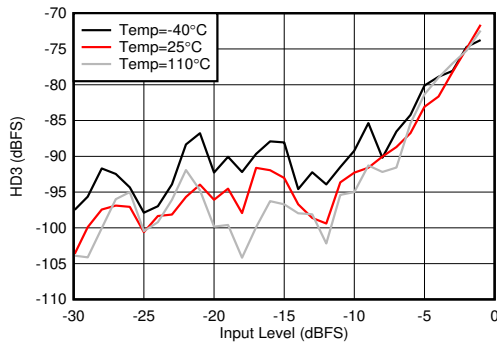

With 3.5 GHz matching, DDC bypass mode (TI only mode for characterization)

Figure 6-161. RX HD3 vs Input Level and Temperature at 3.6 GHz

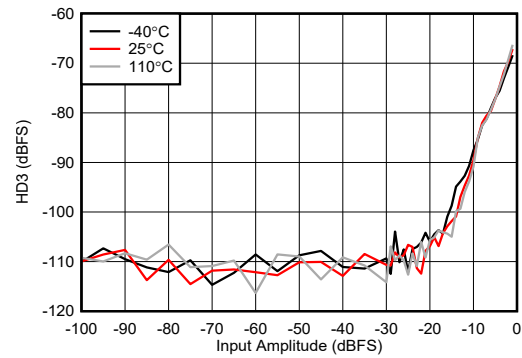

External clock mode, 2x Decimation

Figure 6-162. RX HD3 vs Input Level at 3.76GHz

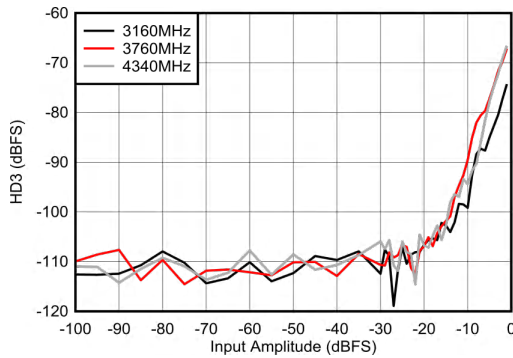

External clock mode, 25°C, 2x Decimation

Figure 6-163. RX HD3 vs Input Level

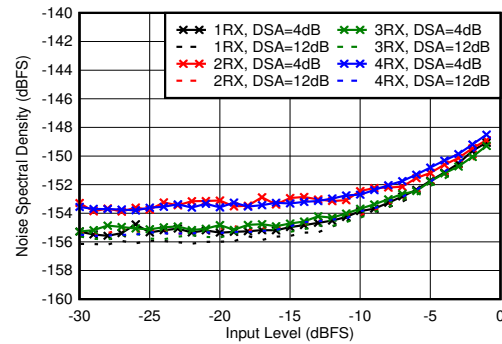

With 3.5 GHz matching, 12.5-MHz offset from tone

Figure 6-164. RX Noise Spectral Density vs Input Level and DSA Setting at 3.6 GHz

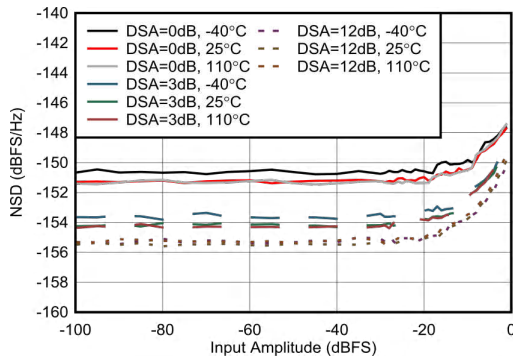

External clock mode, 25°C, 2x Decimation

Figure 6-165. RX Noise Spectral Density vs Input Level at 3.76GHz

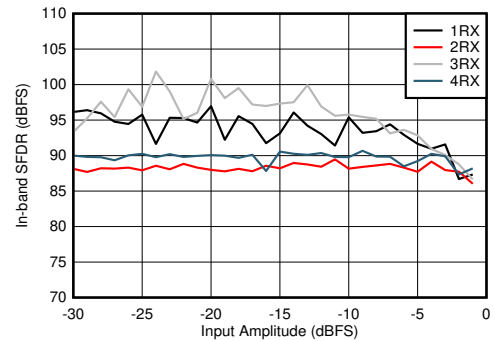

With 3.5 GHz matching

Figure 6-166. RX In-Band SFDR ($\pm 200\text{ MHz}$) vs Input Level and Channel at 3.6 GHz

6.11.5 RX Typical Characteristics 3.5GHz (continued)

Typical values at $T_A = +25^\circ\text{C}$, ADC Sampling Rate = 2949.12 MHz. Default conditions: output sample rate = 491.52MSPS (decimate by 6), PLL clock mode with $f_{REF} = 491.52\text{MHz}$, $A_{IN} = -3\text{ dBFS}$, DSA setting = 4 dB.

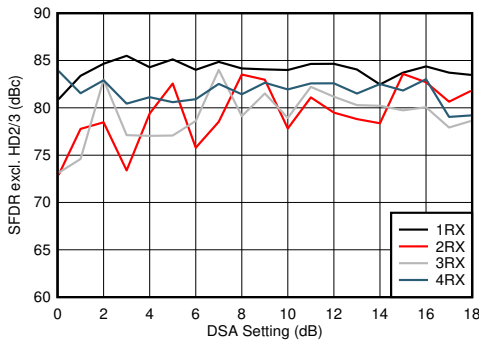

With 3.5 GHz matching

Figure 6-167. RX SFDR Excluding HD2/3 vs DSA Setting and Channel at 3.6 GHz

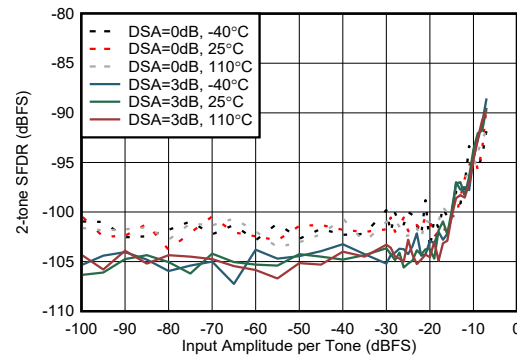

External clock mode, 20MHz tone spacing, excluding 3rd order distortion

Figure 6-168. RX 2-tone SFDR vs Input Amplitude and DSA Setting at 3.7 GHz

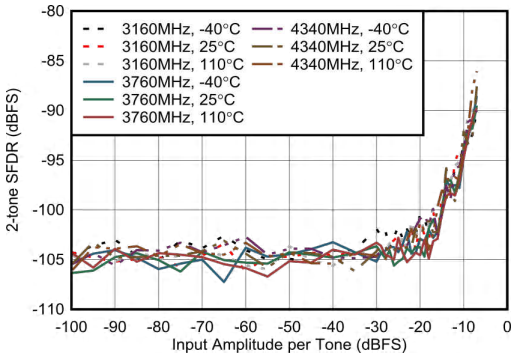

External clock mode, 20MHz tone spacing, excluding 3rd order distortion

Figure 6-169. RX 2-tone SFDR vs Input Amplitude and Frequency at 3.7 GHz

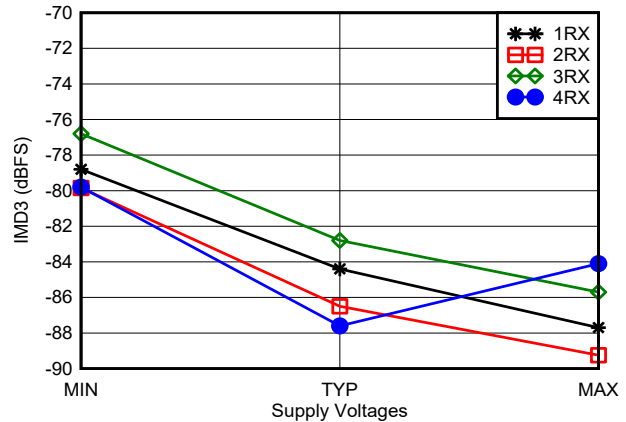

With 3.6 GHz matching, -7 dBFS each tone, 20-MHz tone spacing, all supplies at MIN, TYP, or MAX recommended operating voltages

Figure 6-170. RX IMD3 vs Supply Voltage and Channel at 3.6 GHz

6.11.5 RX Typical Characteristics 3.5GHz (continued)

Typical values at $T_A = +25^\circ\text{C}$, ADC Sampling Rate = 2949.12 MHz. Default conditions: output sample rate = 491.52MSPS (decimate by 6), PLL clock mode with $f_{REF} = 491.52\text{MHz}$, $A_{IN} = -3\text{ dBFS}$, DSA setting = 4 dB.

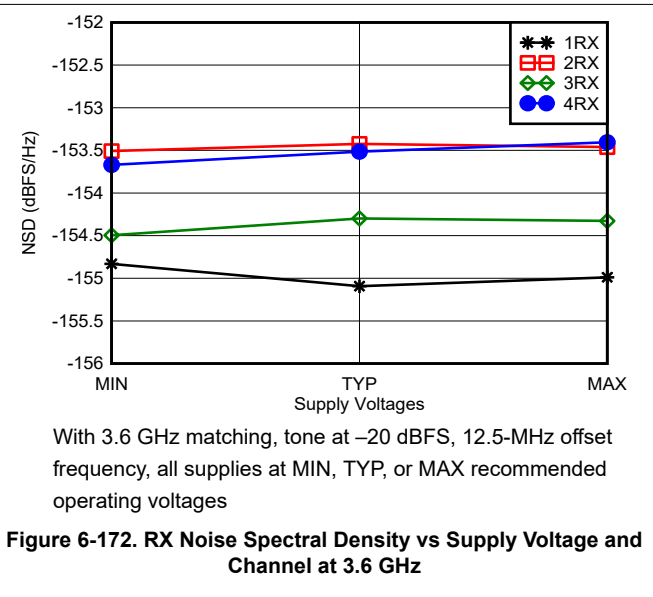
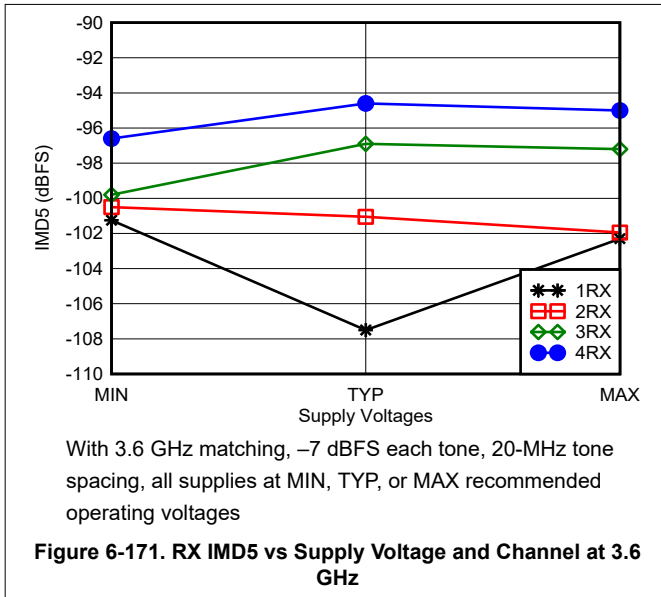

6.11.6 RX Typical Characteristics 4.9GHz

Typical values at $T_A = +25^\circ\text{C}$, ADC Sampling Rate = 2949.12 GHz. Default conditions: output sample rate = 491.52MSPS (decimate by 6), PLL clock mode with $f_{REF} = 491.52\text{MHz}$, $A_{IN} = -3\text{dBFS}$, DSA setting = 4 dB.

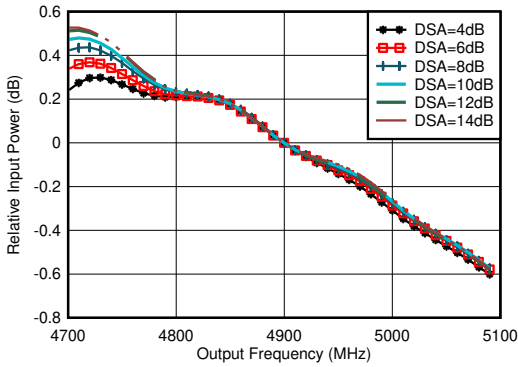

With matching, normalized to power at 4.9GHz for each DSA setting

Figure 6-173. RX Inband Gain Flatness, $f_{IN} = 4900\text{ MHz}$

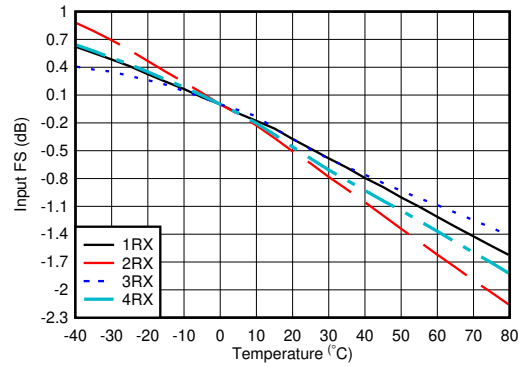

With 4.9 GHz matching, normalized to fullscale at 25°C for each channel

Figure 6-174. RX Input Fullscale vs Temperature and Channel at 4.9 GHz

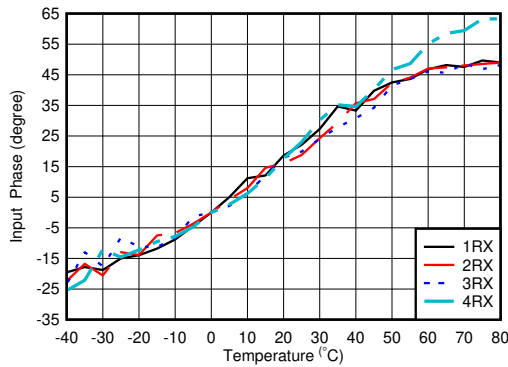

With 4.9 GHz matching, normalized to phase at 25°C

Figure 6-175. RX Input Phase vs Temperature and DSA at $f_{OUT} = 4.9\text{ GHz}$

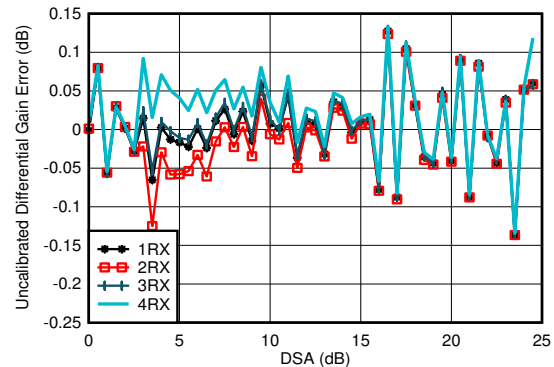

With 4.9 GHz matching

$$\text{Differential Amplitude Error} = P_{IN}(\text{DSA Setting} - 1) - P_{IN}(\text{DSA Setting}) + 1$$

Figure 6-176. RX Uncalibrated Differential Amplitude Error vs DSA Setting at 4.9 GHz

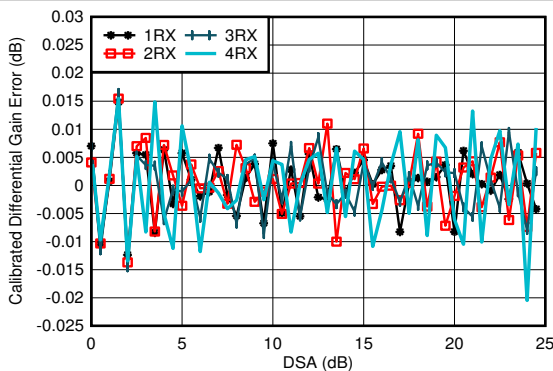

With 4.9 GHz matching

$$\text{Differential Amplitude Error} = P_{IN}(\text{DSA Setting} - 1) - P_{IN}(\text{DSA Setting}) + 1$$

Figure 6-177. RX Calibrated Differential Amplitude Error vs DSA Setting at 4.9 GHz

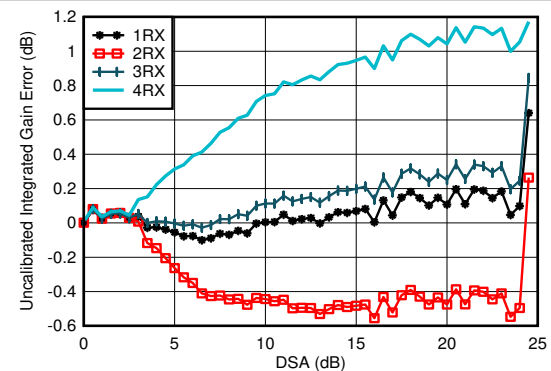

With 4.9 GHz matching

$$\text{Integrated Amplitude Error} = P_{IN}(\text{DSA Setting}) - P_{IN}(\text{DSA Setting} = 0) + (\text{DSA Setting})$$

Figure 6-178. RX Uncalibrated Integrated Amplitude Error vs DSA Setting at 4.9 GHz

6.11.6 RX Typical Characteristics 4.9GHz (continued)

Typical values at $T_A = +25^\circ\text{C}$, ADC Sampling Rate = 2949.12 MHz. Default conditions: output sample rate = 491.52MSPS (decimate by 6), PLL clock mode with $f_{REF} = 491.52\text{MHz}$, $A_{IN} = -3\text{ dBFS}$, DSA setting = 4 dB.

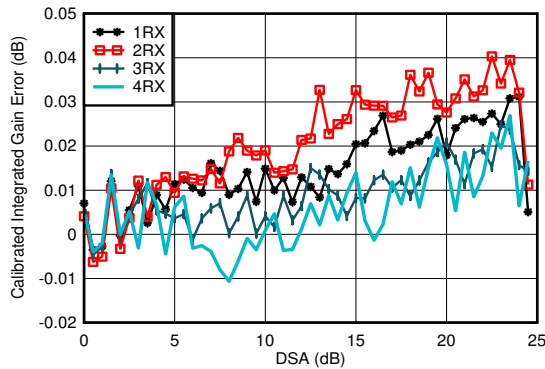

With 4.9 GHz matching
Integrated Amplitude Error = $P_{IN}(\text{DSA Setting}) - P_{IN}(\text{DSA Setting} = 0) + (\text{DSA Setting})$

Figure 6-179. RX Calibrated Integrated Amplitude Error vs DSA Setting at 4.9 GHz

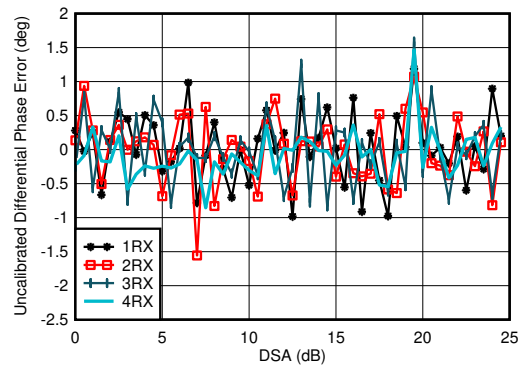

With 4.9 GHz matching
Differential Phase Error = $\text{Phase}_{IN}(\text{DSA Setting} - 1) - \text{Phase}_{IN}(\text{DSA Setting})$

Figure 6-180. RX Uncalibrated Differential Phase Error vs DSA Setting at 4.9 GHz

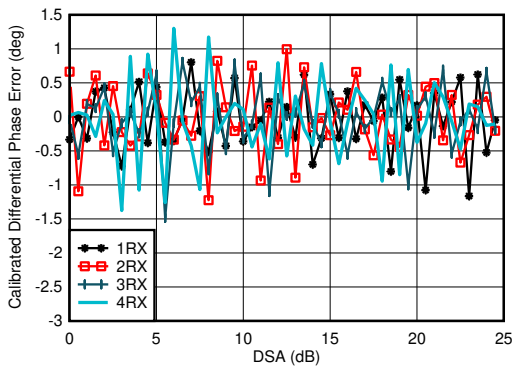

With 4.9 GHz matching
Differential Phase Error = $\text{Phase}_{IN}(\text{DSA Setting} - 1) - \text{Phase}_{IN}(\text{DSA Setting})$

Figure 6-181. RX Calibrated Differential Phase Error vs DSA Setting at 4.9 GHz

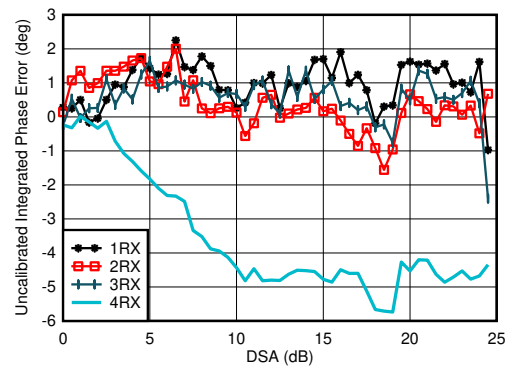

With 4.9 GHz matching
Integrated Phase Error = $\text{Phase}(\text{DSA Setting}) - \text{Phase}(\text{DSA Setting} = 0)$

Figure 6-182. RX Uncalibrated Integrated Phase Error vs DSA Setting at 4.9 GHz

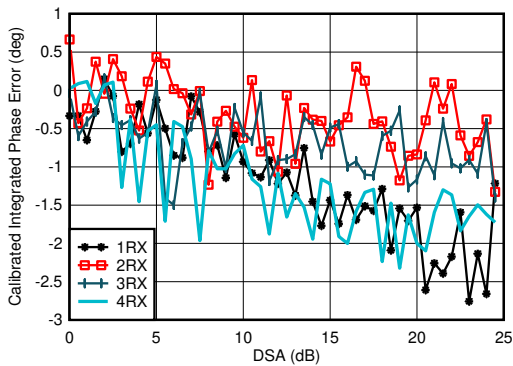

With 4.9 GHz matching
Integrated Phase Error = $\text{Phase}(\text{DSA Setting}) - \text{Phase}(\text{DSA Setting} = 0)$

Figure 6-183. RX Calibrated Integrated Phase Error vs DSA Setting at 4.9 GHz

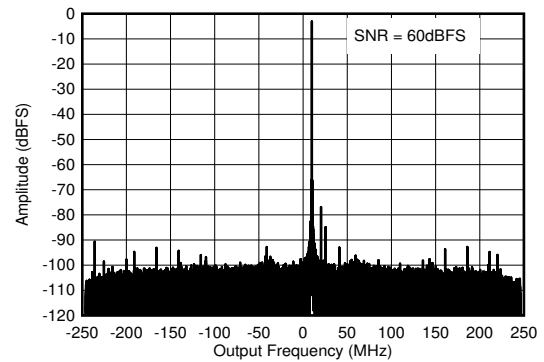

With 4.9 GHz matching, $f_{IN} = 4910\text{ MHz}$, $A_{IN} = -3\text{ dBFS}$

Figure 6-184. RX Output FFT at 4.9 GHz

6.11.6 RX Typical Characteristics 4.9GHz (continued)

Typical values at $T_A = +25^\circ\text{C}$, ADC Sampling Rate = 2949.12 MHz. Default conditions: output sample rate = 491.52MSPS (decimate by 6), PLL clock mode with $f_{REF} = 491.52\text{MHz}$, $A_{IN} = -3\text{ dBFS}$, DSA setting = 4 dB.

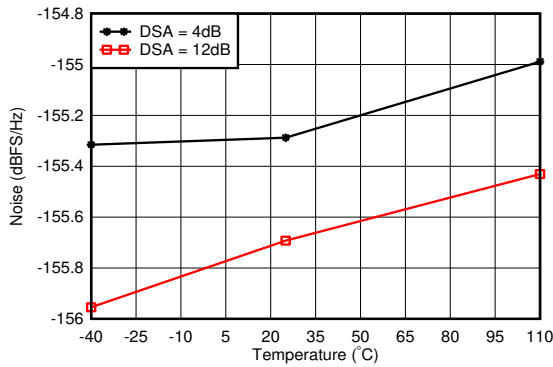

With 4.9 GHz matching, 12.5-MHz offset from tone

Figure 6-185. RX Noise Spectral Density vs Temperature at 4.9 GHz

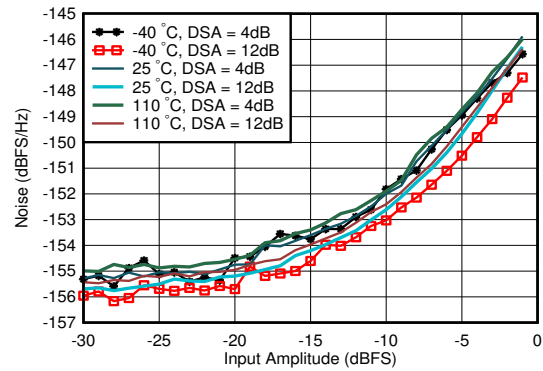

With 4.9 GHz matching, DSA Setting = 12 dB, 12.5-MHz offset from tone

Figure 6-186. RX Noise Spectral Density vs Input Amplitude and Temperature at 4.9 GHz

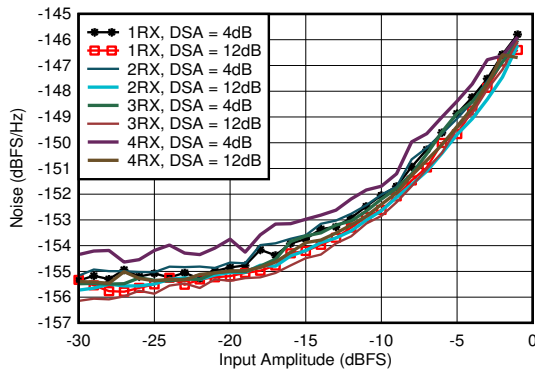

With 4.9 GHz matching, 12.5-MHz offset from tone

Figure 6-187. RX Noise Spectral Density vs Input Amplitude and Channel at 4.9 GHz

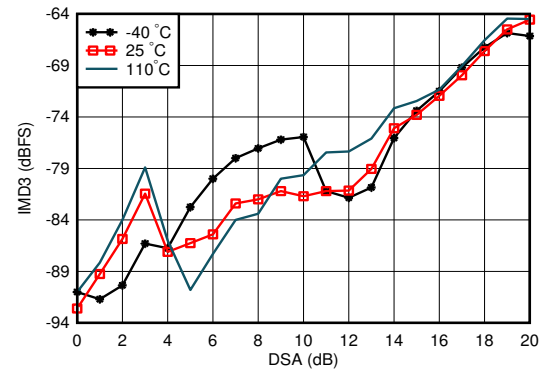

With 4.9 GHz matching, each tone -7 dBFS , tone spacing = 20 MHz

Figure 6-188. RX IMD3 vs DSA Setting and Temperature at 4.9 GHz

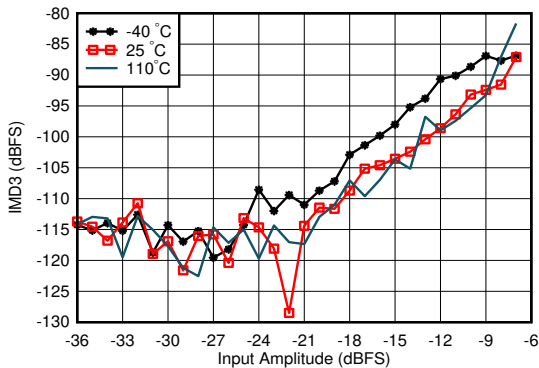

With 4.9 GHz matching, tone spacing = 20 MHz, DSA = 4 dB

Figure 6-189. RX IMD3 vs Input Level and Temperature at 4.9 GHz

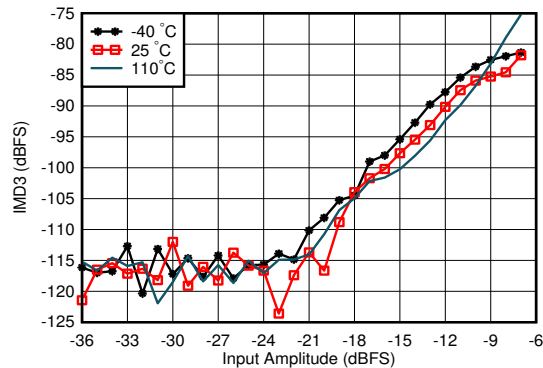

With 4.9 GHz matching, tone spacing = 20 MHz, DSA = 12 dB

Figure 6-190. RX IMD3 vs Input Level and Temperature at 4.9 GHz

6.11.6 RX Typical Characteristics 4.9GHz (continued)

Typical values at $T_A = +25^\circ\text{C}$, ADC Sampling Rate = 2949.12 GHz. Default conditions: output sample rate = 491.52MSPS (decimate by 6), PLL clock mode with $f_{REF} = 491.52\text{MHz}$, $A_{IN} = -3\text{ dBFS}$, DSA setting = 4 dB.

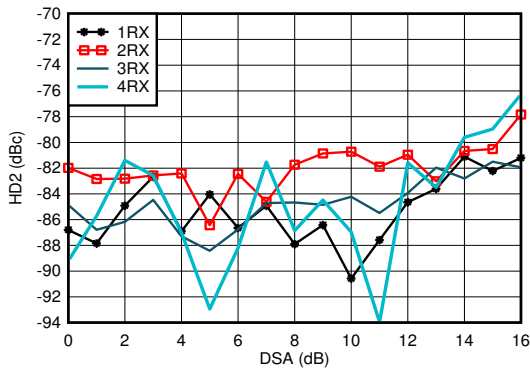

With 4.9 GHz matching, measured after HD2 trim, DDC bypass mode (TI only mode for characterization)

Figure 6-191. RX HD2 vs DSA Setting and Channel at 4.9 GHz

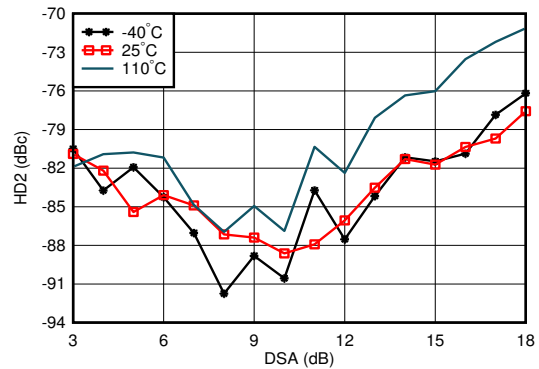

With 4.9 GHz matching, measured after HD2 trim, DDC bypass mode (TI only mode for characterization)

Figure 6-192. RX HD2 vs DSA and Temperature at 4.9 GHz

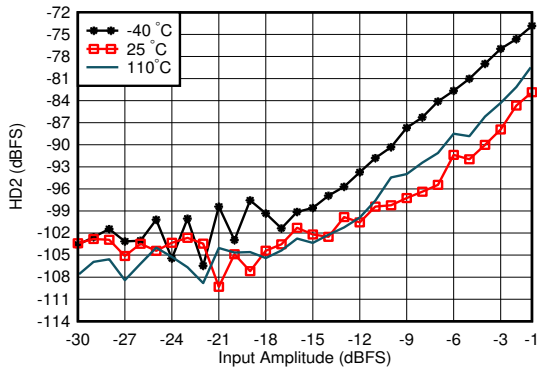

With 4.9 GHz matching, measured after HD2 trim, DDC bypass mode (TI only mode for characterization)

Figure 6-193. RX HD2 vs Input Level and Temperature at 4.9 GHz

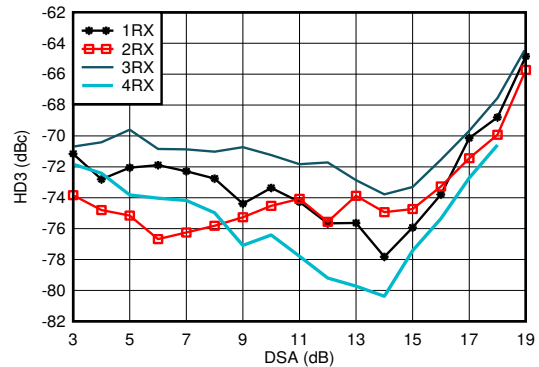

With 4.9 GHz matching, DDC bypass mode (TI only mode for characterization)

Figure 6-194. RX HD3 vs DSA Setting and Channel at 4.9 GHz

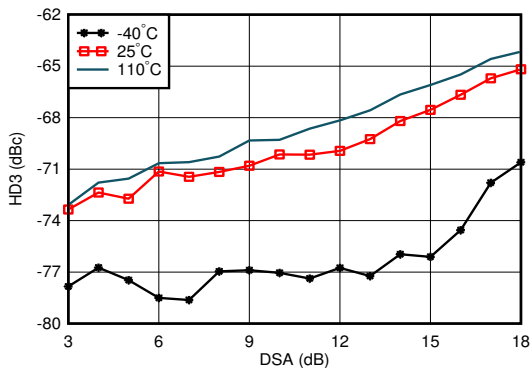

With 4.9 GHz matching, DDC bypass mode (TI only mode for characterization)

Figure 6-195. RX HD3 vs DSA Setting and Temperature at 4.9 GHz

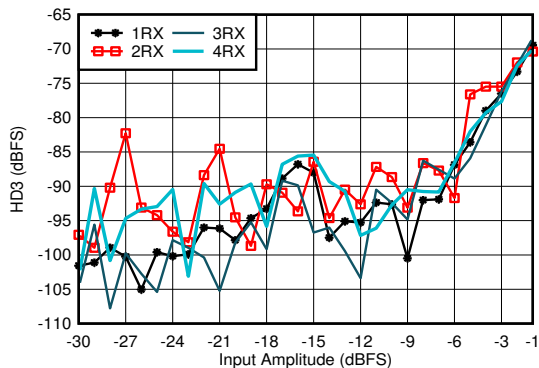

With 4.9 GHz matching, DDC bypass mode (TI only mode for characterization)

Figure 6-196. RX HD3 vs Input Level and Channel at 4.9 GHz

6.11.6 RX Typical Characteristics 4.9GHz (continued)

Typical values at $T_A = +25^\circ\text{C}$, ADC Sampling Rate = 2949.12 MHz. Default conditions: output sample rate = 491.52MSPS (decimate by 6), PLL clock mode with $f_{REF} = 491.52\text{MHz}$, $A_{IN} = -3\text{ dBFS}$, DSA setting = 4 dB.

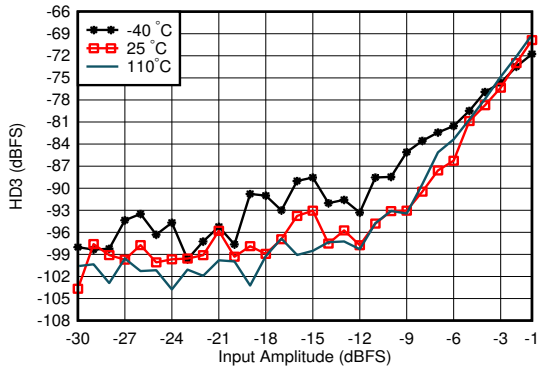

With 4.9 GHz matching, DDC bypass mode (TI only mode for characterization)

Figure 6-197. RX HD3 vs Input Level and Temperature at 4.9 GHz

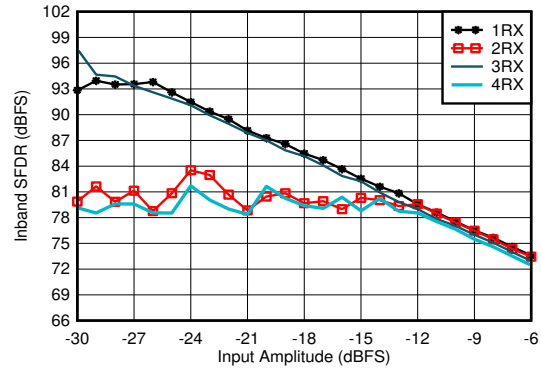

With 4.9 GHz matching, decimate by 3

Figure 6-198. RX In-Band SFDR ($\pm 400\text{ MHz}$) vs Input Amplitude and Channel at 4.9 GHz

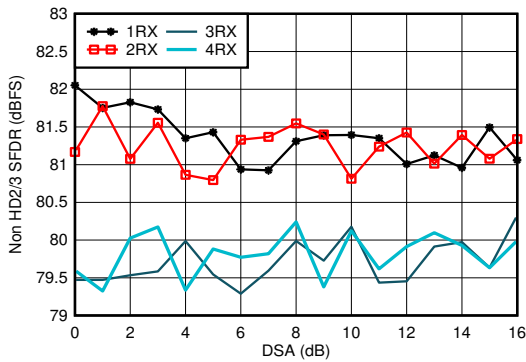

With 4.9 GHz matching

Figure 6-199. RX Non-HD2/3 vs DSA Setting at 4.9 GHz

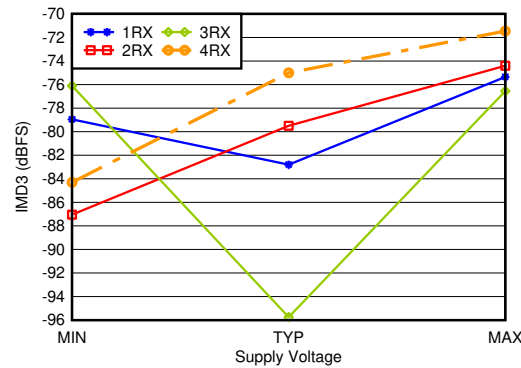

With 4.9 GHz matching, -7 dBFS each tone, 20-MHz tone spacing, all supplies at MIN, TYP, or MAX recommended operating voltages

Figure 6-200. RX IMD3 vs Supply and Channel at 4.9 GHz

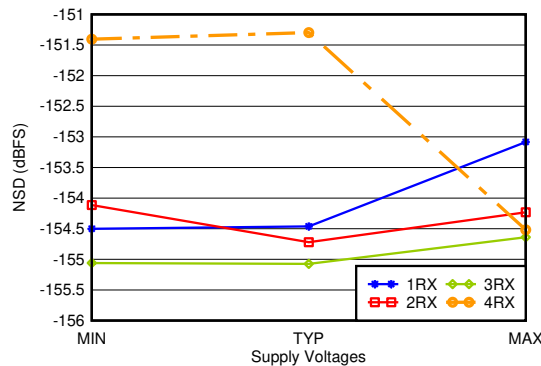

With 4.9 GHz matching, 12.5-MHz offset, all supplies at MIN, TYP, or MAX recommended operating voltages

Figure 6-201. RX Noise Spectral Density vs Supply and Channel at 4.9 GHz

6.11.7 RX Typical Characteristics 6.8GHz

Typical values at $T_A = +25^\circ\text{C}$. Default conditions at 30MHz: ADC Sampling Rate = 3000MSPS, output sample rate = 1500MSPS (decimate by 2x), External clock mode, $A_{IN} = -3$ dBFS, DSA setting = 3 dB.

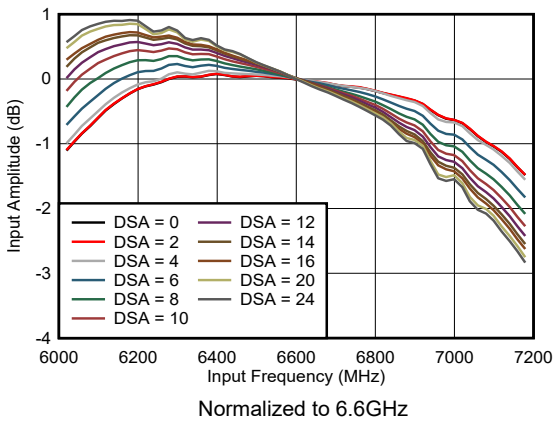

Figure 6-202. RX In-Band Gain Flatness

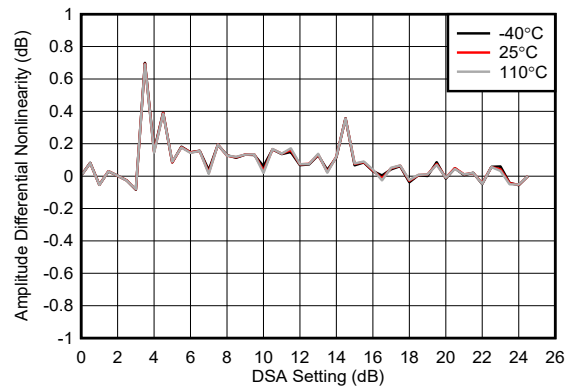

Figure 6-203. RX Uncalibrated Differential Amplitude Error at 6.851GHz

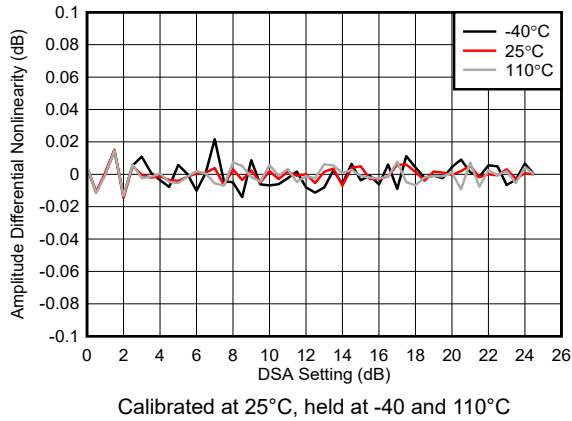

Figure 6-204. RX Calibrated Differential Amplitude Error at 6.851GHz

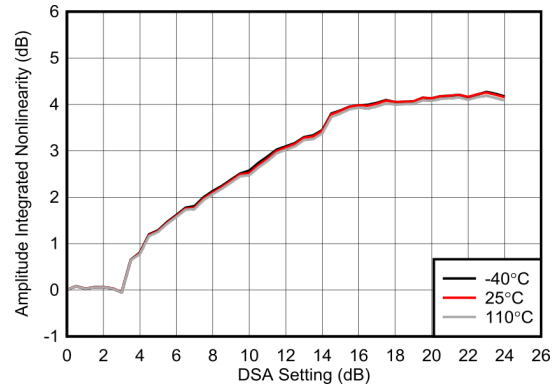

Figure 6-205. RX Uncalibrated Integrated Amplitude Error at 6.851GHz

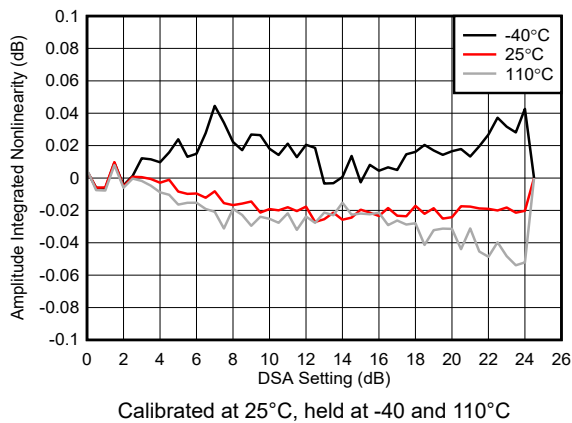

Figure 6-206. RX Calibrated Integrated Amplitude Error at 6.851GHz

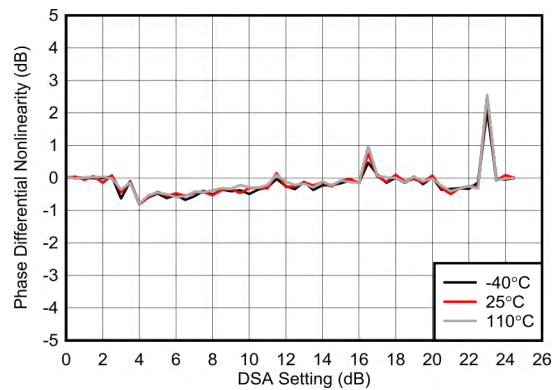
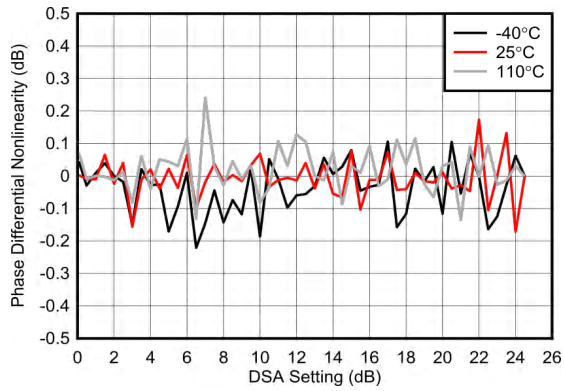

Figure 6-207. RX Uncalibrated Differential Phase Error at 6.851GHz

6.11.7 RX Typical Characteristics 6.8GHz (continued)

Typical values at $T_A = +25^\circ\text{C}$. Default conditions at 30MHz: ADC Sampling Rate = 3000MSPS, output sample rate = 1500MSPS (decimate by 2x), External clock mode , $A_{IN} = -3 \text{ dBFS}$, DSA setting = 3 dB.



Calibrated at 25°C, held at -40 and 110°C

Figure 6-208. RX Calibrated Differential Phase Error at 6.851GHz

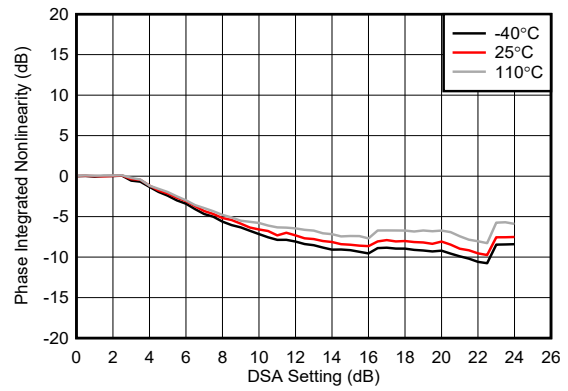
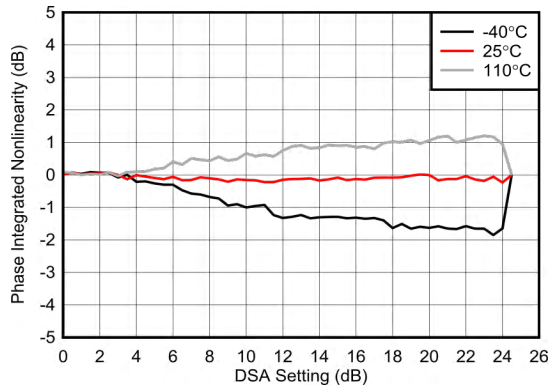
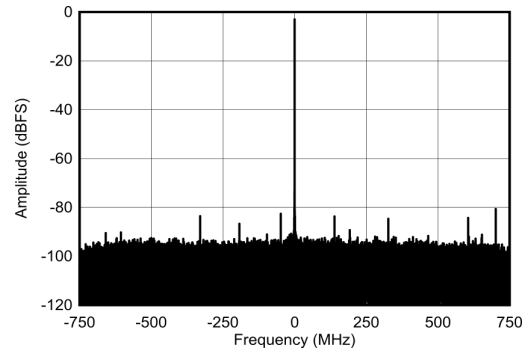

Figure 6-209. RX Uncalibrated Integrated Phase Error at 6.851GHz



Calibrated at 25°C, held at -40 and 110°C

Figure 6-210. RX Calibrated Integrated Phase Error at 6.851GHz



$F_{NCO} = 6.851\text{GHz}$, F_{IN} offset -130kHz

Figure 6-211. RX Output FFT at 6.851GHz and -3dBFS

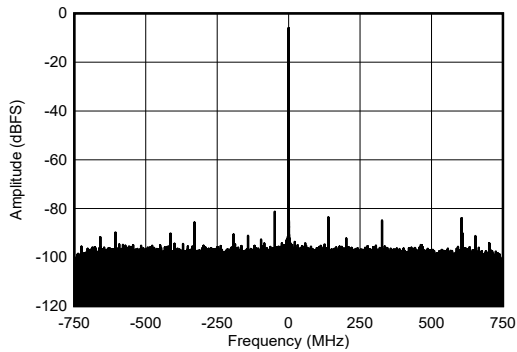

$F_{NCO} = 6.851\text{GHz}$, F_{IN} offset -130kHz

Figure 6-212. RX Output FFT at 6.851GHz and -6dBFS

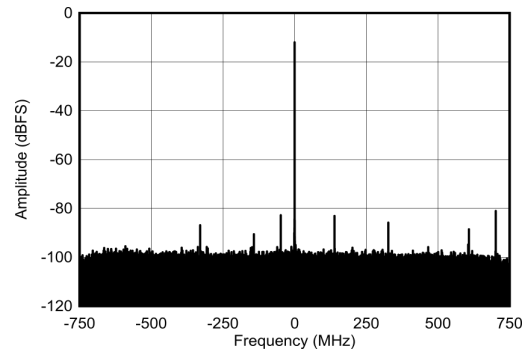

$F_{NCO} = 6.851\text{GHz}$, F_{IN} offset -130kHz

Figure 6-213. RX Output FFT at 6.851GHz and -12dBFS

6.11.7 RX Typical Characteristics 6.8GHz (continued)

Typical values at $T_A = +25^\circ\text{C}$. Default conditions at 30MHz: ADC Sampling Rate = 3000MSPS, output sample rate = 1500MSPS (decimate by 2x), External clock mode, $A_{IN} = -3\text{ dBFS}$, DSA setting = 3 dB.

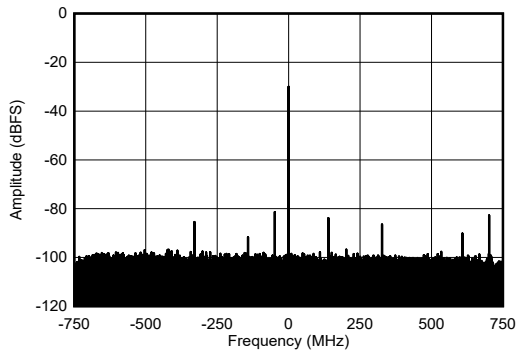

$F_{NCO} = 6.851\text{GHz}$, F_{IN} offset -130kHz

Figure 6-214. RX Output FFT at 6.851GHz and -30dBFS

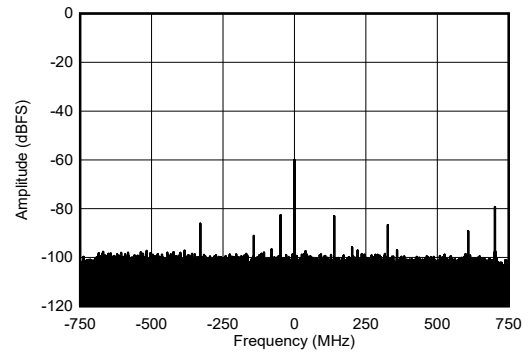

$F_{NCO} = 6.851\text{GHz}$, F_{IN} offset -130kHz

Figure 6-215. RX Output FFT at 6.851GHz and -60dBFS

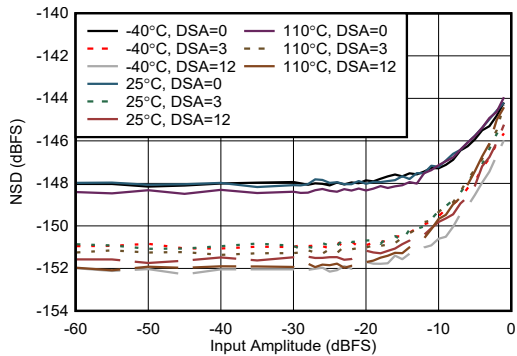
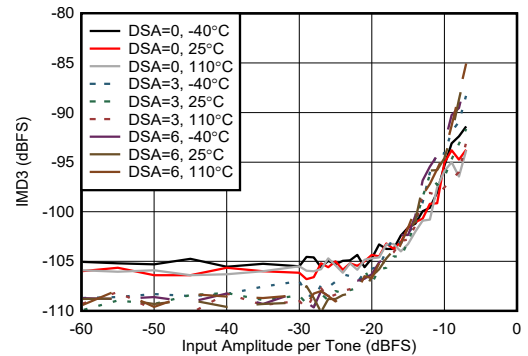
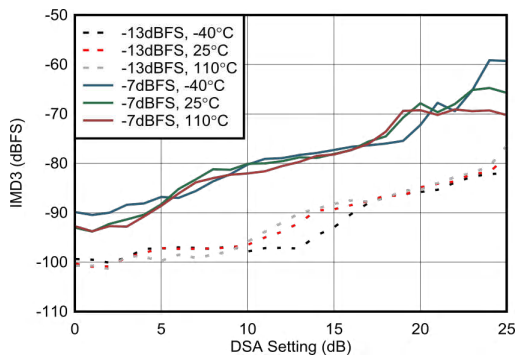

Figure 6-216. RX NSD vs Input Amplitude at 6.851GHz



100MHz Tone Spacing

Figure 6-217. RX IMD3 vs Input Amplitude at 6.851GHz



100MHz Tone Spacing

Figure 6-218. RX IMD3 vs DSA Setting at 6.851GHz

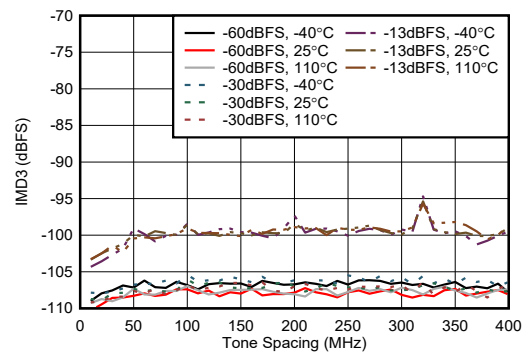

Figure 6-219. RX IMD3 vs Tone Spacing at 6.851GHz

6.11.7 RX Typical Characteristics 6.8GHz (continued)

Typical values at $T_A = +25^\circ\text{C}$. Default conditions at 30MHz: ADC Sampling Rate = 3000MSPS, output sample rate = 1500MSPS (decimate by 2x), External clock mode , $A_{IN} = -3$ dBFS, DSA setting = 3 dB.

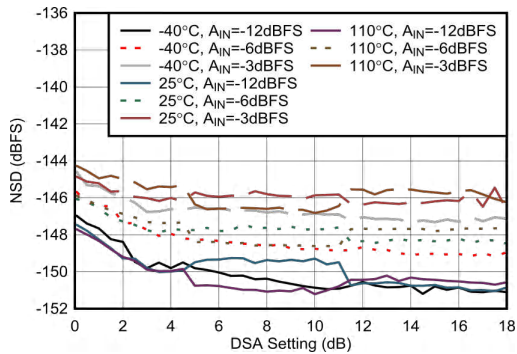

Figure 6-220. RX NSD vs DSA Setting at 6.851GHz

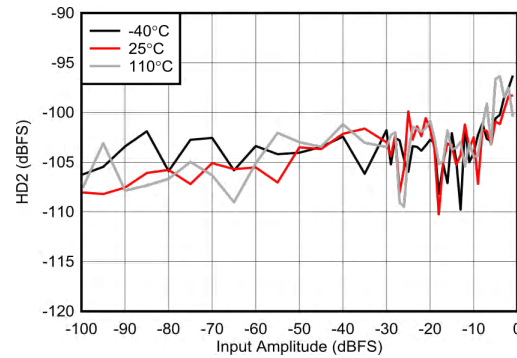

Figure 6-221. RX HD2 vs Input Amplitude at 6.851GHz

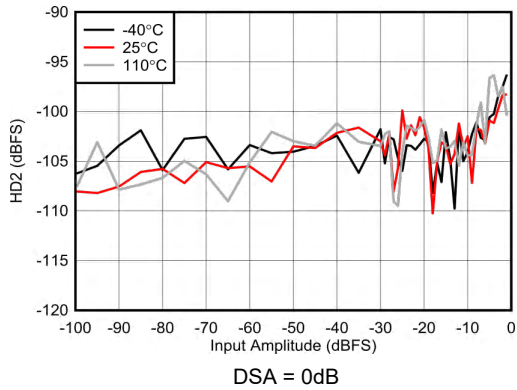

Figure 6-222. RX HD2 vs Input Amplitude at 6.851GHz

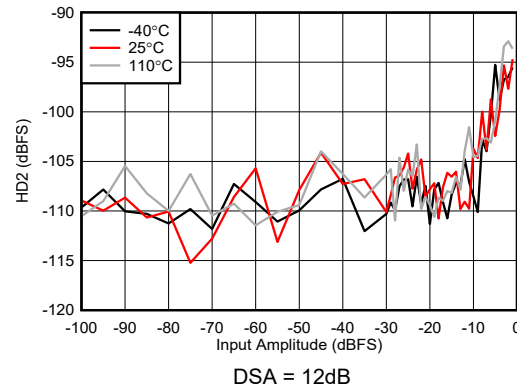

Figure 6-223. RX HD2 vs Input Amplitude at 6.851GHz

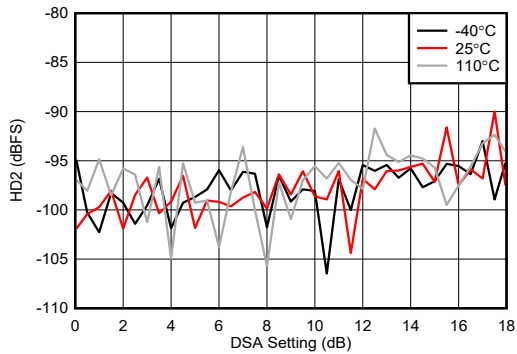

Figure 6-224. RX HD2 vs DSA Setting at 6.851GHz

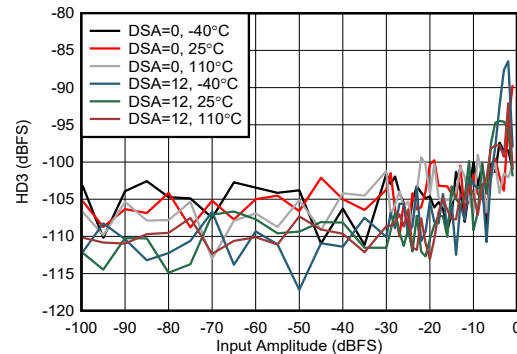

Figure 6-225. RX HD3 vs Input Amplitude at 6.851GHz

6.11.7 RX Typical Characteristics 6.8GHz (continued)

Typical values at $T_A = +25^\circ\text{C}$. Default conditions at 30MHz: ADC Sampling Rate = 3000MSPS, output sample rate = 1500MSPS (decimate by 2x), External clock mode, $A_{IN} = -3 \text{ dBFS}$, DSA setting = 3 dB.

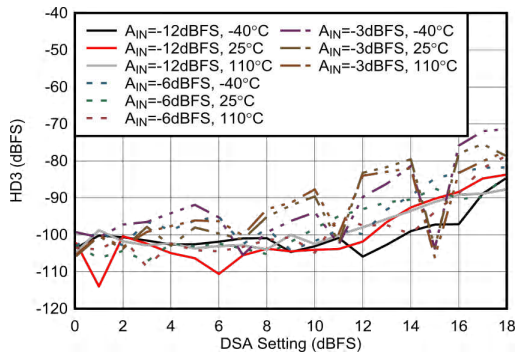
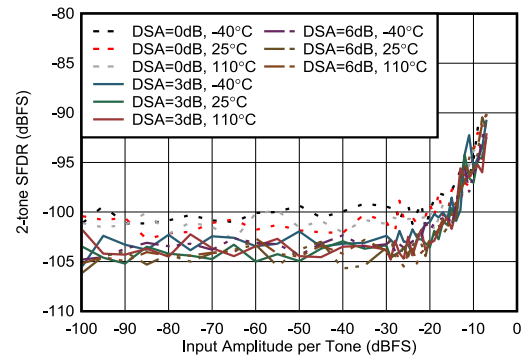

Figure 6-226. RX HD3 vs DSA Setting at 6.851GHz



100MHz tone spacing, excluding 3rd order distortion

Figure 6-227. RX 2-tone SFDR vs Input Amplitude at 6.85GHz

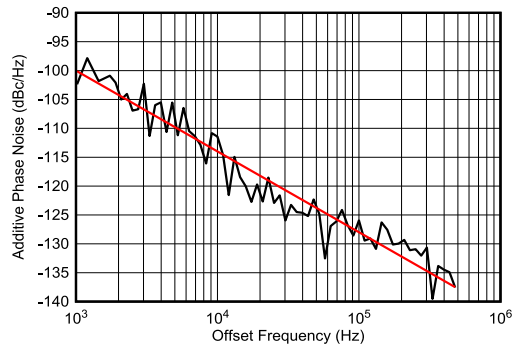
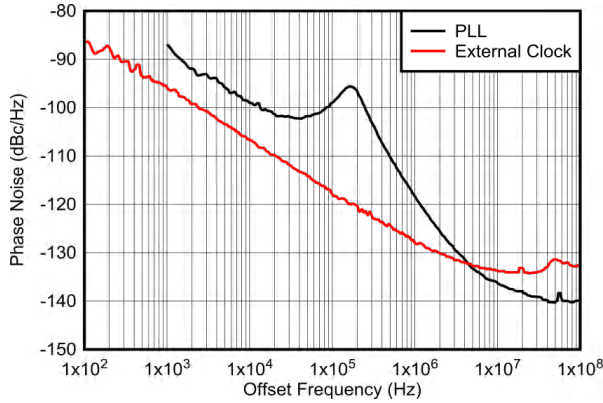

Figure 6-228. RX Additive Phase Noise at 6.85GHz

6.11.8 PLL and Clock Typical Characteristics

Typical values at $T_A = +25^\circ\text{C}$ with nominal supplies. Unless otherwise noted, $f_{\text{REF}} = 491.52 \text{ MHz}$, Phase noise measured at TX output



measured at TX output, normalized to 12GHz by $20 \cdot \log_{10}(12\text{GHz}/F_{\text{OUT}})$

Figure 6-229. Phase Noise vs Offset Frequency for PLL and External Clock at 12GHz

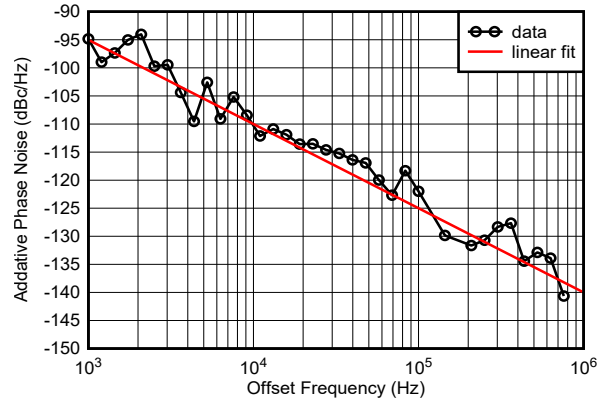
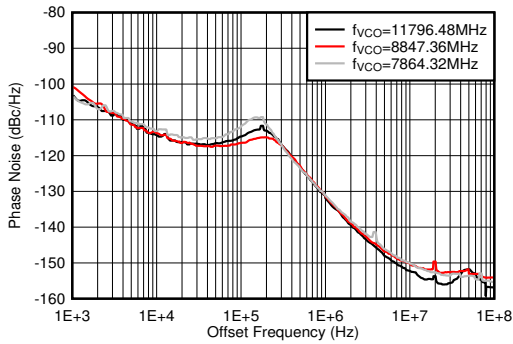
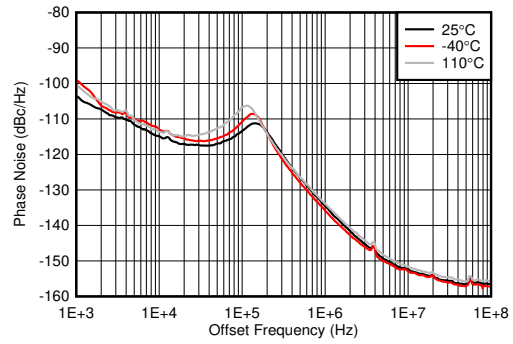

Figure 6-230. RX Additive Phase Noise at 9.61GHz



PLL enabled, $f_{\text{REF}} = 491.52\text{MSPS}$, measured at 2TXOUT

Figure 6-231. Phase Noise vs Offset Frequency and f_{VCO} at $f_{\text{OUT}} = 2610 \text{ MHz}$



PLL enabled, $f_{\text{VCO}} = 11796.48 \text{ MHz}$, $f_{\text{REF}} = 491.52\text{MSPS}$, measured at 2TXOUT

Figure 6-232. Phase Noise for 12-GHz VCO vs Offset Frequency and Temperature at $f_{\text{OUT}} = 1910 \text{ MHz}$

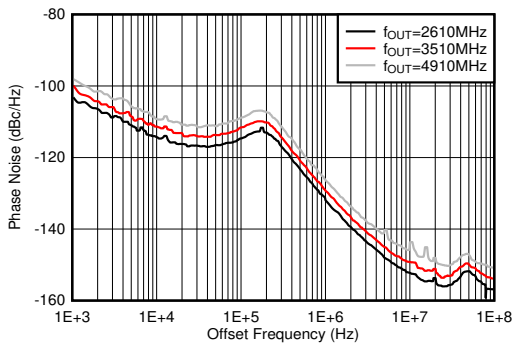

PLL enabled, $f_{\text{VCO}} = 11796.48 \text{ MHz}$, $f_{\text{REF}} = 491.52\text{MSPS}$, measured at 2TXOUT

Figure 6-233. Phase Noise for 12-GHz VCO vs Offset Frequency and f_{OUT} at 25°C

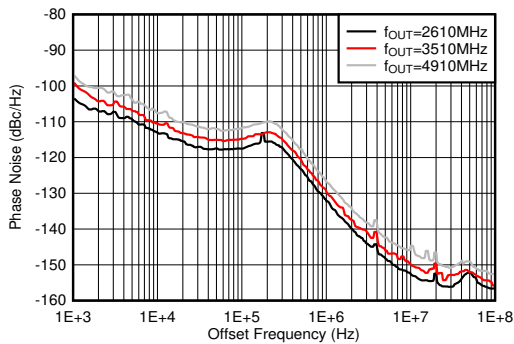

PLL enabled, $f_{\text{VCO}} = 11796.48 \text{ MHz}$, $f_{\text{REF}} = 491.52\text{MSPS}$, measured at 2TXOUT

Figure 6-234. Phase Noise for 12-GHz VCO vs Offset Frequency and f_{OUT} at -40°C

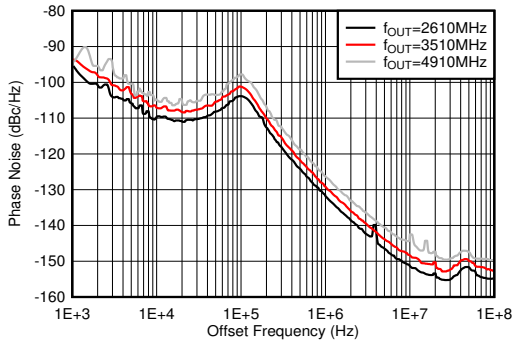

PLL enabled, $f_{VCO} = 11796.48$ MHz, $f_{REF} = 491.52$ MSPS, measured at 2TXOUT

Figure 6-235. Phase Noise for 12-GHz VCO vs Offset Frequency and f_{OUT} at 110°C

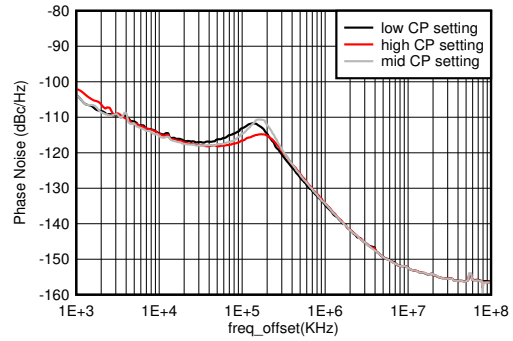

PLL enabled, $f_{VCO} = 11796.48$ MHz, $f_{REF} = 491.52$ MSPS, measured at 2TXOUT

Figure 6-236. Phase Noise for 12-GHz VCO vs Offset Frequency and CP Setting at $f_{OUT} = 2.6$ GHz

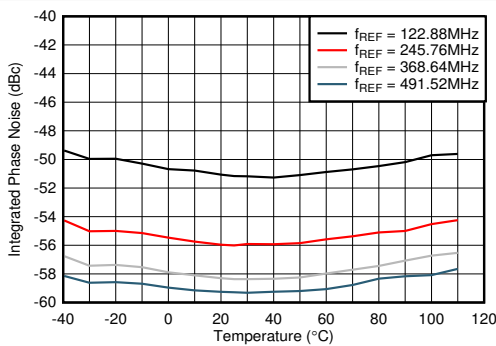

PLL enabled, $f_{VCO} = 11796.48$ MHz, 1-kHz to 100-MHz, single-sided integration bandwidth, measured at 2TXOUT

Figure 6-237. Integrated Phase Noise for 12-GHz VCO vs Temperature and f_{REF} at $f_{OUT} = 2.6$ GHz

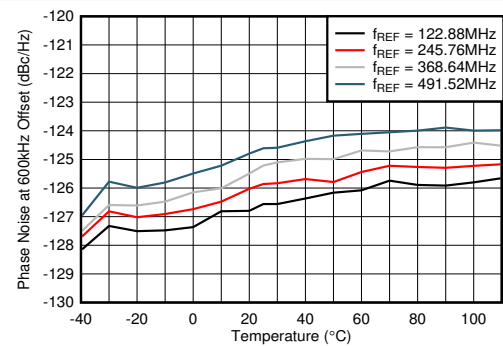

PLL enabled, $f_{VCO} = 11796.48$ MHz, measured at 2TXOUT

Figure 6-238. Phase Noise for 12-GHz VCO at 600kHz Offset vs Temperature and f_{REF} at $f_{OUT} = 2.6$ GHz

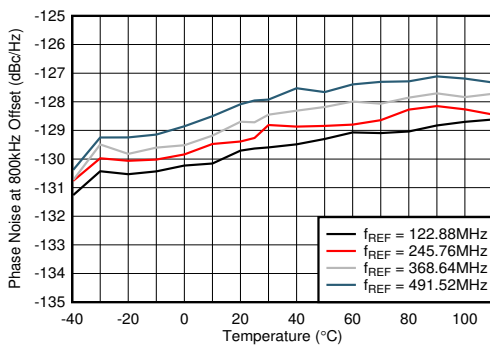

A. PLL enabled, $f_{VCO} = 11796.48$ MHz, measured at 2TXOUT

Figure 6-239. Phase Noise for 12-GHz VCO at 800-kHz Offset vs Temperature and f_{REF} at $f_{OUT} = 2.6$ GHz

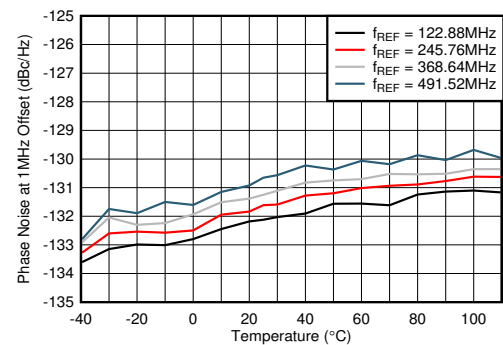

PLL enabled, $f_{VCO} = 11796.48$ MHz, measured at 2TXOUT

Figure 6-240. Phase Noise for 12-GHz VCO at 1-MHz Offset vs Temperature and f_{REF} at $f_{OUT} = 2.6$ GHz

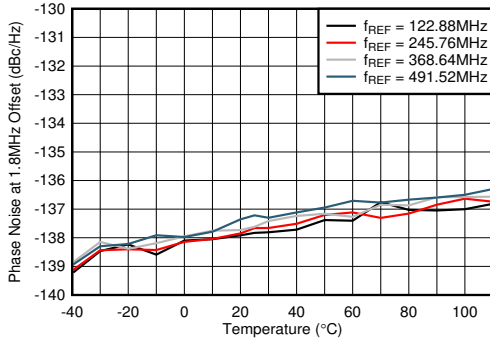

PLL enabled, $f_{VCO} = 11796.48$ MHz, measured at 2TXOUT

Figure 6-241. Phase Noise for 12-GHz VCO at 1.8-MHz Offset vs Temperature and f_{REF} at $f_{OUT} = 2.6$ GHz

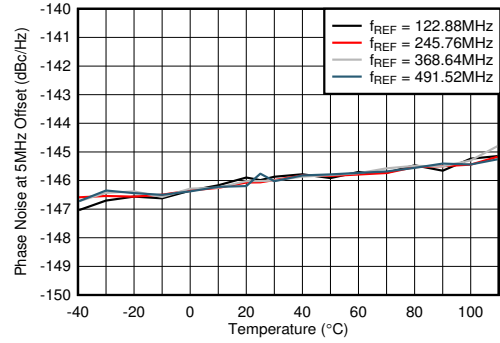

PLL enabled, $f_{VCO} = 11796.48$ MHz, measured at 2TXOUT

Figure 6-242. Phase Noise for 12-GHz VCO at 5-MHz Offset vs Temperature and f_{REF} at $f_{OUT} = 2.6$ GHz

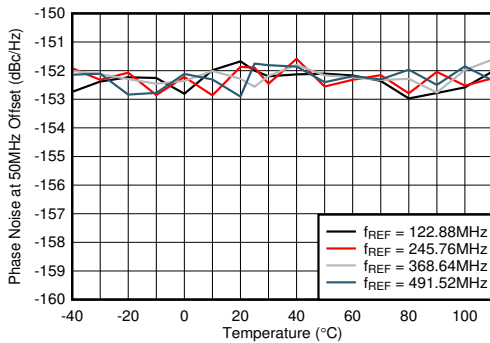

PLL enabled, $f_{VCO} = 11796.48$ MHz, measured at 2TXOUT

Figure 6-243. Phase Noise for 12-GHz VCO at 50-MHz Offset vs Temperature and f_{REF} at $f_{OUT} = 2.6$ GHz

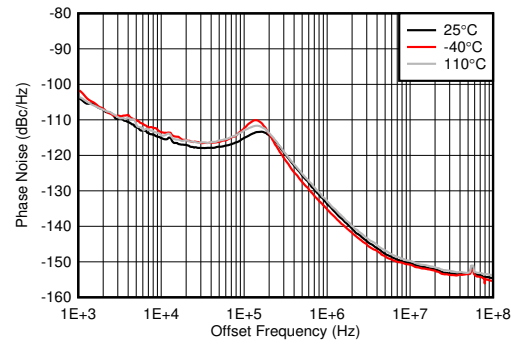

PLL enabled, $f_{VCO} = 9830.4$ MHz, $f_{REF} = 491.52$ MSPS, measured at 2TXOUT

Figure 6-244. Phase Noise for 10-GHz VCO vs Offset Frequency and Temperature at $f_{OUT} = 1910$ MHz

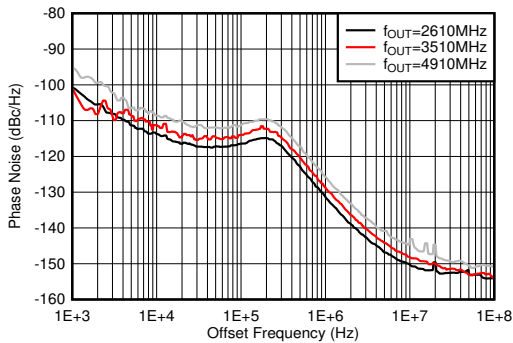

PLL enabled, $f_{VCO} = 9830.4$ MHz, $f_{REF} = 491.52$ MSPS, measured at 2TXOUT

Figure 6-245. Phase Noise for 10-GHz VCO vs Offset Frequency and f_{OUT} at 25°C

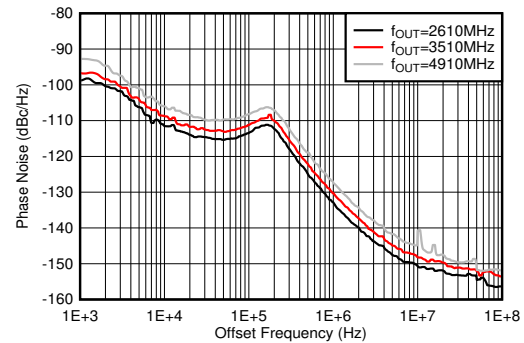

PLL enabled, $f_{VCO} = 9830.4$ MHz, $f_{REF} = 491.52$ MSPS, measured at 2TXOUT

Figure 6-246. Phase Noise for 10-GHz VCO vs Offset Frequency and f_{OUT} at -40°C

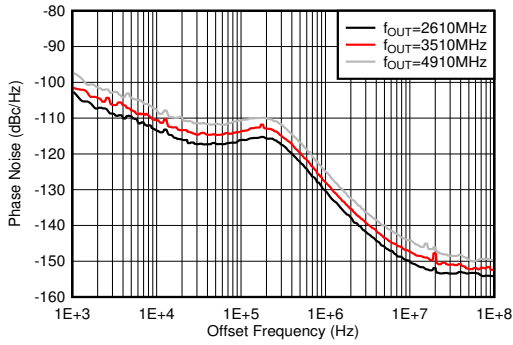

PLL enabled, $f_{VCO} = 9830.4$ MHz, $f_{REF} = 491.52$ MSPS, measured at 2TXOUT

Figure 6-247. Phase Noise for 10-GHz VCO vs Offset Frequency and f_{OUT} at 110°C

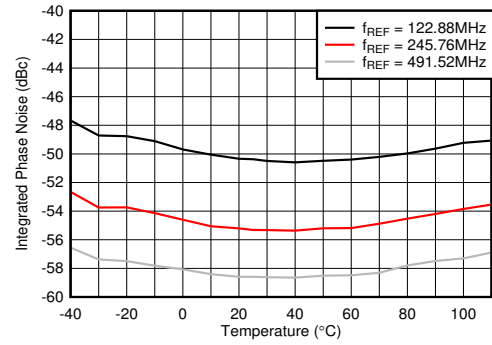

PLL enabled, $f_{VCO} = 9830.4$ MHz, 1-kHz to 100-MHz, single-sided integration bandwidth, measured at 2TXOUT

Figure 6-248. Integrated Phase Noise for 10-GHz VCO vs Temperature and f_{REF} at $f_{OUT} = 2.6$ GHz

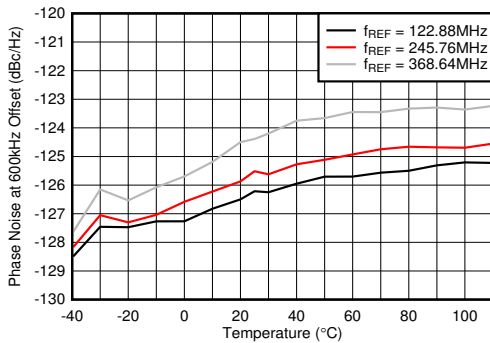

PLL enabled, $f_{VCO} = 9830.4$ MHz, measured at 2TXOUT

Figure 6-249. Phase Noise for 10-GHz VCO at 600 kHz vs Temperature and f_{REF} at $f_{OUT} = 2.6$ GHz

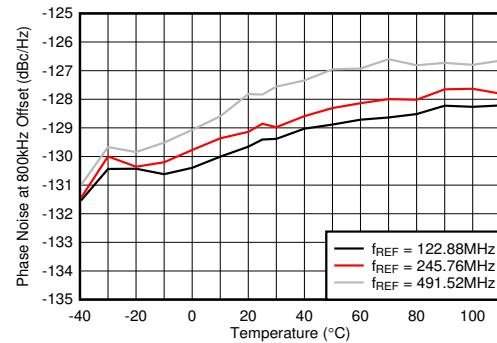

PLL enabled, $f_{VCO} = 9830.4$ MHz, measured at 2TXOUT

Figure 6-250. Phase Noise for 10-GHz VCO at 800 kHz vs Temperature and f_{REF} at $f_{OUT} = 2.6$ GHz

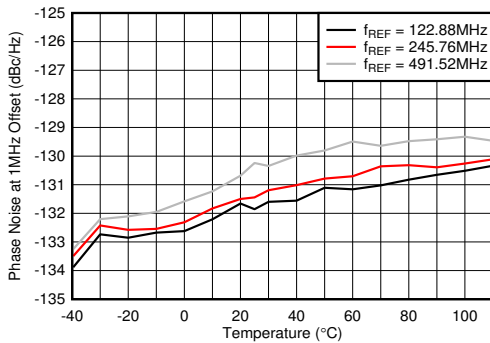

PLL enabled, $f_{VCO} = 9830.4$ MHz, measured at 2TXOUT

Figure 6-251. Phase Noise for 10-GHz VCO at 1 MHz vs Temperature and f_{REF} at $f_{OUT} = 2.6$ GHz

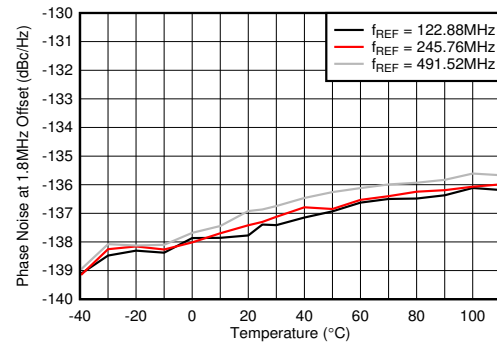

PLL enabled, $f_{VCO} = 9830.4$ MHz, measured at 2TXOUT

Figure 6-252. Phase Noise for 10-GHz VCO at 1.8 MHz vs Temperature and f_{REF} at $f_{OUT} = 2.6$ GHz

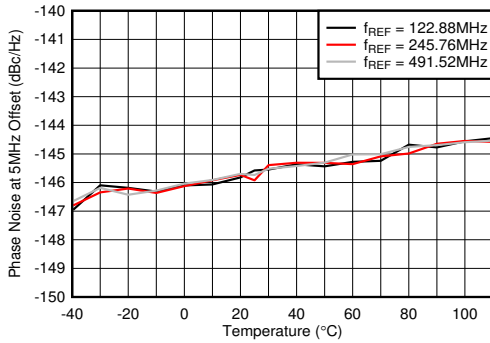

PLL enabled, $f_{VCO} = 9830.4$ MHz, measured at 2TXOUT

Figure 6-253. Phase Noise for 10-GHz VCO at 5 MHz vs Temperature and f_{REF} at $f_{OUT} = 2.6$ GHz

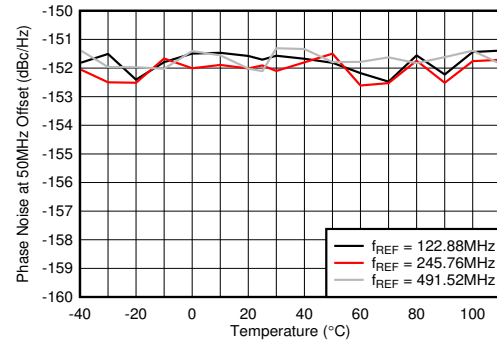

PLL enabled, $f_{VCO} = 9830.4$ MHz, measured at 2TXOUT

Figure 6-254. Phase Noise for 10-GHz VCO at 50 MHz vs Temperature and f_{REF} at $f_{OUT} = 2.6$ GHz

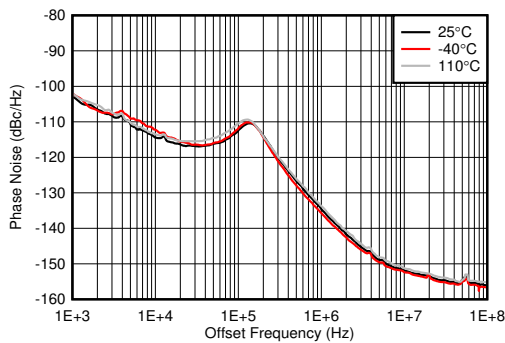

PLL enabled, $f_{VCO} = 8847.36$ MHz, $f_{REF} = 491.52$ MSPS, measured at 2TXOUT

Figure 6-255. Phase Noise for 9-GHz VCO vs Offset Frequency and Temperature at $f_{OUT} = 1910$ MHz

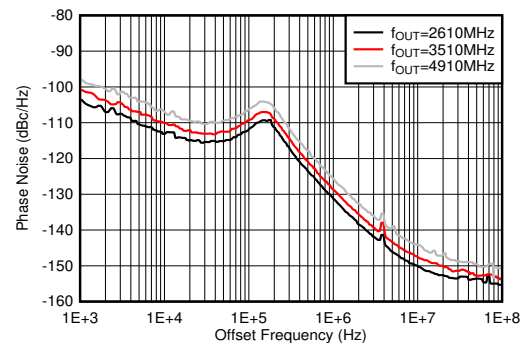

PLL enabled, $f_{VCO} = 8847.36$ MHz, $f_{REF} = 491.52$ MSPS, measured at 2TXOUT

Figure 6-256. Phase Noise for 9-GHz VCO vs Offset Frequency and f_{OUT} at 25°C

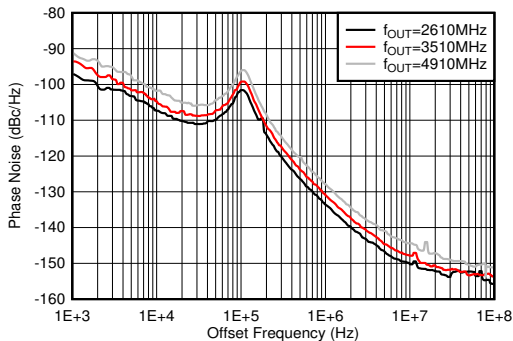

PLL enabled, $f_{VCO} = 8847.36$ MHz, $f_{REF} = 491.52$ MSPS, measured at 2TXOUT

Figure 6-257. Phase Noise for 9-GHz VCO vs Offset Frequency and f_{OUT} at -40°C

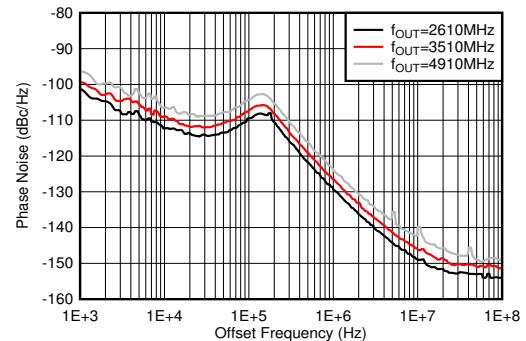

PLL enabled, $f_{VCO} = 8847.36$ MHz, $f_{REF} = 491.52$ MSPS, measured at 2TXOUT

Figure 6-258. Phase Noise for 9-GHz VCO vs Offset Frequency and f_{OUT} at 110°C

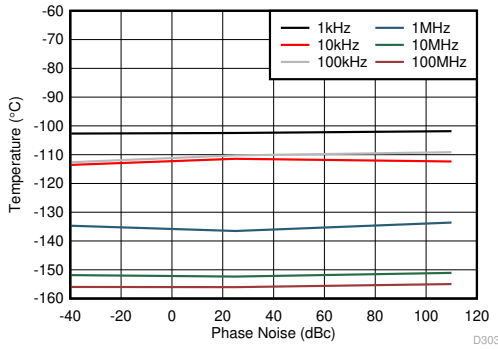

PLL enabled, $f_{VCO} = 8847.36$ MHz, $f_{REF} = 491.52$ MSPS, minimum LPF BW, measured at 2TXOUT

Figure 6-259. Phase Noise for 9-GHz VCO vs Temperature Over Offset Frequency at $f_{OUT} = 2.6$ GHz

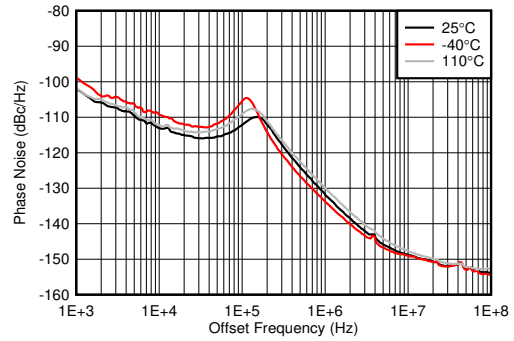

PLL enabled, $f_{VCO} = 7864.32$ MHz, $f_{REF} = 491.52$ MSPS, measured at 2TXOUT

Figure 6-260. Phase Noise for 8-GHz VCO vs Offset Frequency and Temperature at $f_{OUT} = 1910$ MHz

7 Device and Documentation Support

7.1 Receiving Notification of Documentation Updates

To receive notification of documentation updates, navigate to the device product folder on [ti.com](https://www.ti.com). Click on *Subscribe to updates* to register and receive a weekly digest of any product information that has changed. For change details, review the revision history included in any revised document.

7.2 Support Resources

TI E2E™ [support forums](#) are an engineer's go-to source for fast, verified answers and design help — straight from the experts. Search existing answers or ask your own question to get the quick design help you need.

Linked content is provided "AS IS" by the respective contributors. They do not constitute TI specifications and do not necessarily reflect TI's views; see TI's [Terms of Use](#).

7.3 Trademarks

TI E2E™ is a trademark of Texas Instruments.

All trademarks are the property of their respective owners.

7.4 Electrostatic Discharge Caution



This integrated circuit can be damaged by ESD. Texas Instruments recommends that all integrated circuits be handled with appropriate precautions. Failure to observe proper handling and installation procedures can cause damage.

ESD damage can range from subtle performance degradation to complete device failure. Precision integrated circuits may be more susceptible to damage because very small parametric changes could cause the device not to meet its published specifications.

7.5 Glossary

[TI Glossary](#) This glossary lists and explains terms, acronyms, and definitions.

8 Mechanical, Packaging, and Orderable Information

The following pages include mechanical, packaging, and orderable information. This information is the most current data available for the designated devices. This data is subject to change without notice and revision of this document. For browser-based versions of this data sheet, refer to the left-hand navigation.

PACKAGING INFORMATION

Orderable Device	Status (1)	Package Type	Package Drawing	Pins	Package Qty	Eco Plan (2)	Lead finish/ Ball material (6)	MSL Peak Temp (3)	Op Temp (°C)	Device Marking (4/5)	Samples
AFE7906IABJ	ACTIVE	FCBGA	ABJ	400	90	RoHS & Green	SNAGCU	Level-3-260C-168 HR	-40 to 85	AFE7906I	Samples
AFE7906IALK	ACTIVE	FCBGA	ALK	400	90	Non-RoHS & Green	Call TI	Level-3-220C-168 HR	-40 to 85	AFE7906 SNPB	Samples

(1) The marketing status values are defined as follows:

ACTIVE: Product device recommended for new designs.

LIFEBUY: TI has announced that the device will be discontinued, and a lifetime-buy period is in effect.

NRND: Not recommended for new designs. Device is in production to support existing customers, but TI does not recommend using this part in a new design.

PREVIEW: Device has been announced but is not in production. Samples may or may not be available.

OBSOLETE: TI has discontinued the production of the device.

(2) **RoHS:** TI defines "RoHS" to mean semiconductor products that are compliant with the current EU RoHS requirements for all 10 RoHS substances, including the requirement that RoHS substance do not exceed 0.1% by weight in homogeneous materials. Where designed to be soldered at high temperatures, "RoHS" products are suitable for use in specified lead-free processes. TI may reference these types of products as "Pb-Free".

RoHS Exempt: TI defines "RoHS Exempt" to mean products that contain lead but are compliant with EU RoHS pursuant to a specific EU RoHS exemption.

Green: TI defines "Green" to mean the content of Chlorine (Cl) and Bromine (Br) based flame retardants meet JS709B low halogen requirements of <=1000ppm threshold. Antimony trioxide based flame retardants must also meet the <=1000ppm threshold requirement.

(3) MSL, Peak Temp. - The Moisture Sensitivity Level rating according to the JEDEC industry standard classifications, and peak solder temperature.

(4) There may be additional marking, which relates to the logo, the lot trace code information, or the environmental category on the device.

(5) Multiple Device Markings will be inside parentheses. Only one Device Marking contained in parentheses and separated by a "-" will appear on a device. If a line is indented then it is a continuation of the previous line and the two combined represent the entire Device Marking for that device.

(6) Lead finish/Ball material - Orderable Devices may have multiple material finish options. Finish options are separated by a vertical ruled line. Lead finish/Ball material values may wrap to two lines if the finish value exceeds the maximum column width.

Important Information and Disclaimer:The information provided on this page represents TI's knowledge and belief as of the date that it is provided. TI bases its knowledge and belief on information provided by third parties, and makes no representation or warranty as to the accuracy of such information. Efforts are underway to better integrate information from third parties. TI has taken and continues to take reasonable steps to provide representative and accurate information but may not have conducted destructive testing or chemical analysis on incoming materials and chemicals. TI and TI suppliers consider certain information to be proprietary, and thus CAS numbers and other limited information may not be available for release.

In no event shall TI's liability arising out of such information exceed the total purchase price of the TI part(s) at issue in this document sold by TI to Customer on an annual basis.

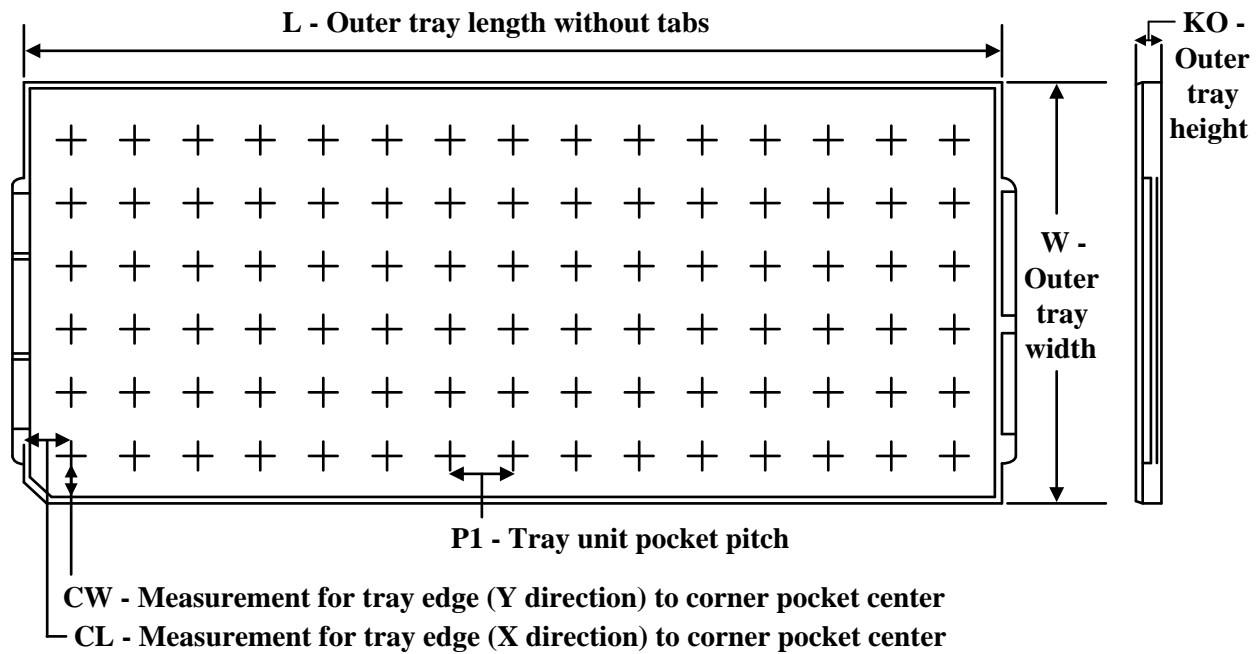
TRAY

Chamfer on Tray corner indicates Pin 1 orientation of packed units.

*All dimensions are nominal

Device	Package Name	Package Type	Pins	SPQ	Unit array matrix	Max temperature (°C)	L (mm)	W (mm)	K0 (µm)	P1 (mm)	CL (mm)	CW (mm)
AFE7906IABJ	ABJ	FCBGA	400	90	6 x 16	150	315	135.9	7620	19.5	21	19.2
AFE7906IALK	ALK	FCBGA	400	90	6 x 16	150	315	135.9	7620	19.5	21	19.2

ABJ0400A

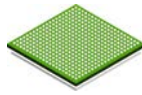

PACKAGE OUTLINE

FCBGA - 2.65 mm max height

BALL GRID ARRAY

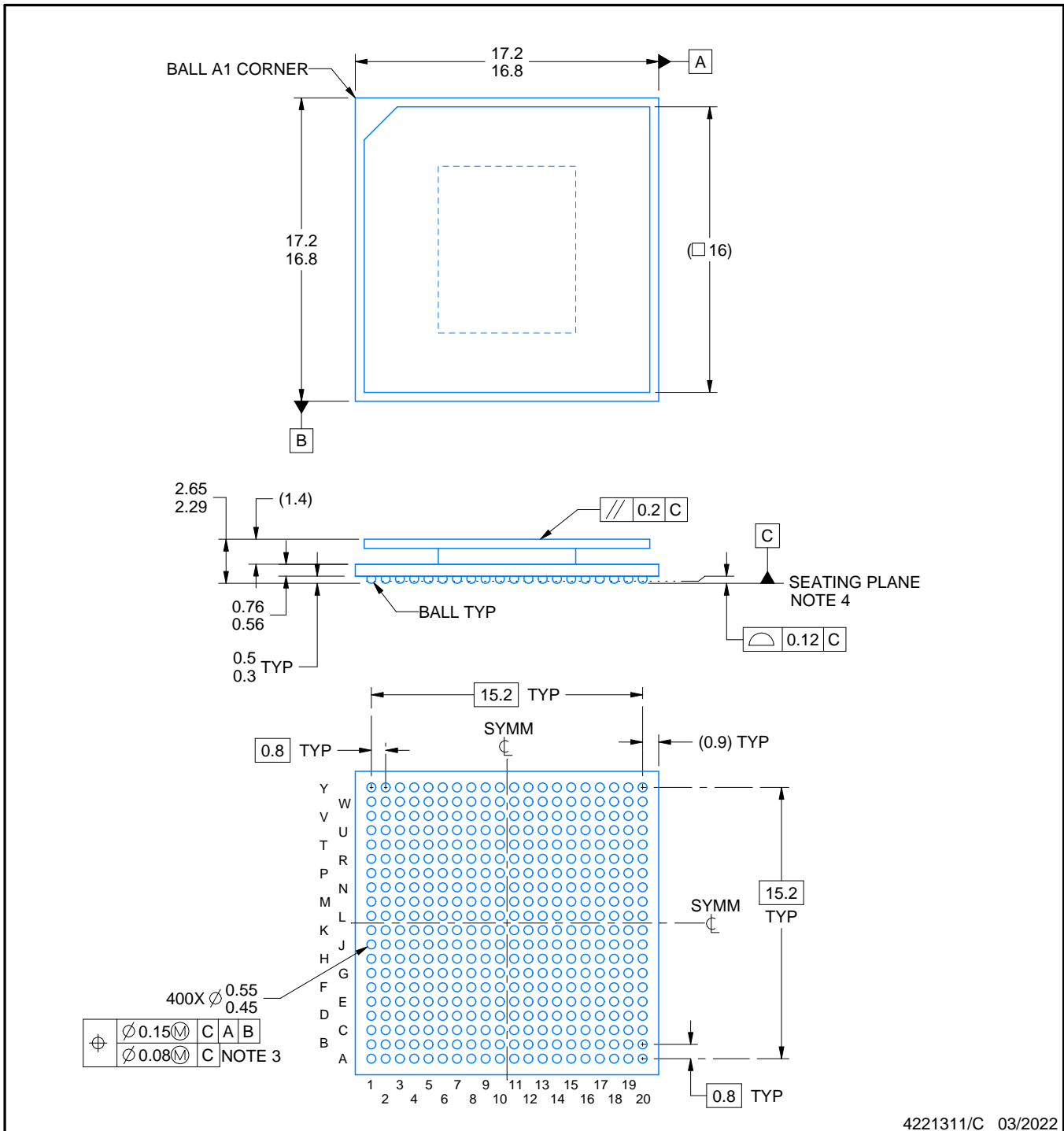

4221311/C 03/2022

NOTES:

- All linear dimensions are in millimeters. Any dimensions in parenthesis are for reference only. Dimensioning and tolerancing per ASME Y14.5M.
- This drawing is subject to change without notice.
- Dimension is measured at the maximum solder ball diameter, parallel to primary datum C.
- Primary datum C and seating plane are defined by the spherical crowns of the solder balls.

EXAMPLE BOARD LAYOUT

ABJ0400A

FCBGA - 2.65 mm max height

BALL GRID ARRAY

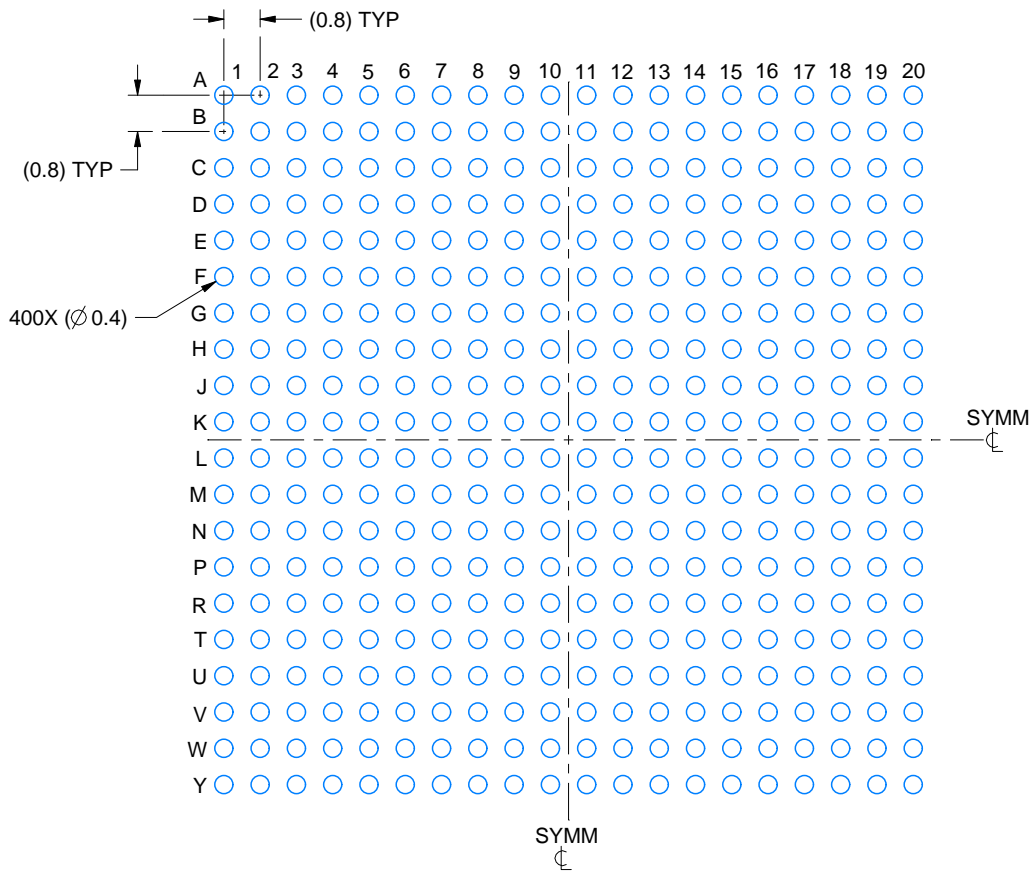

LAND PATTERN EXAMPLE
EXPOSED METAL SHOWN
SCALE:6X

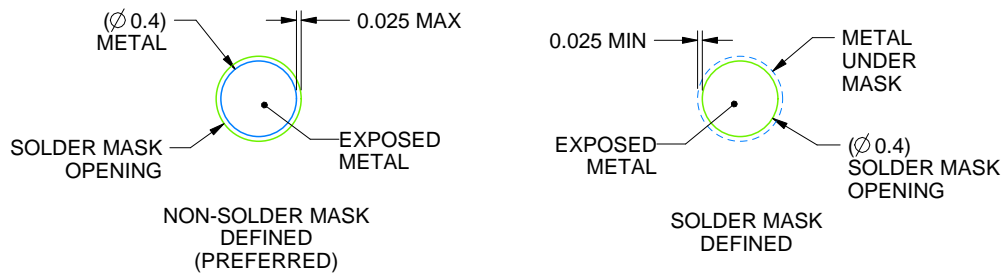

SOLDER MASK DETAILS
NOT TO SCALE

4221311/C 03/2022

NOTES: (continued)

- Final dimensions may vary due to manufacturing tolerance considerations and also routing constraints. For more information, see Texas Instruments literature number SPRU811 (www.ti.com/lit/spru811).

EXAMPLE STENCIL DESIGN

ABJ0400A

FCBGA - 2.65 mm max height

BALL GRID ARRAY

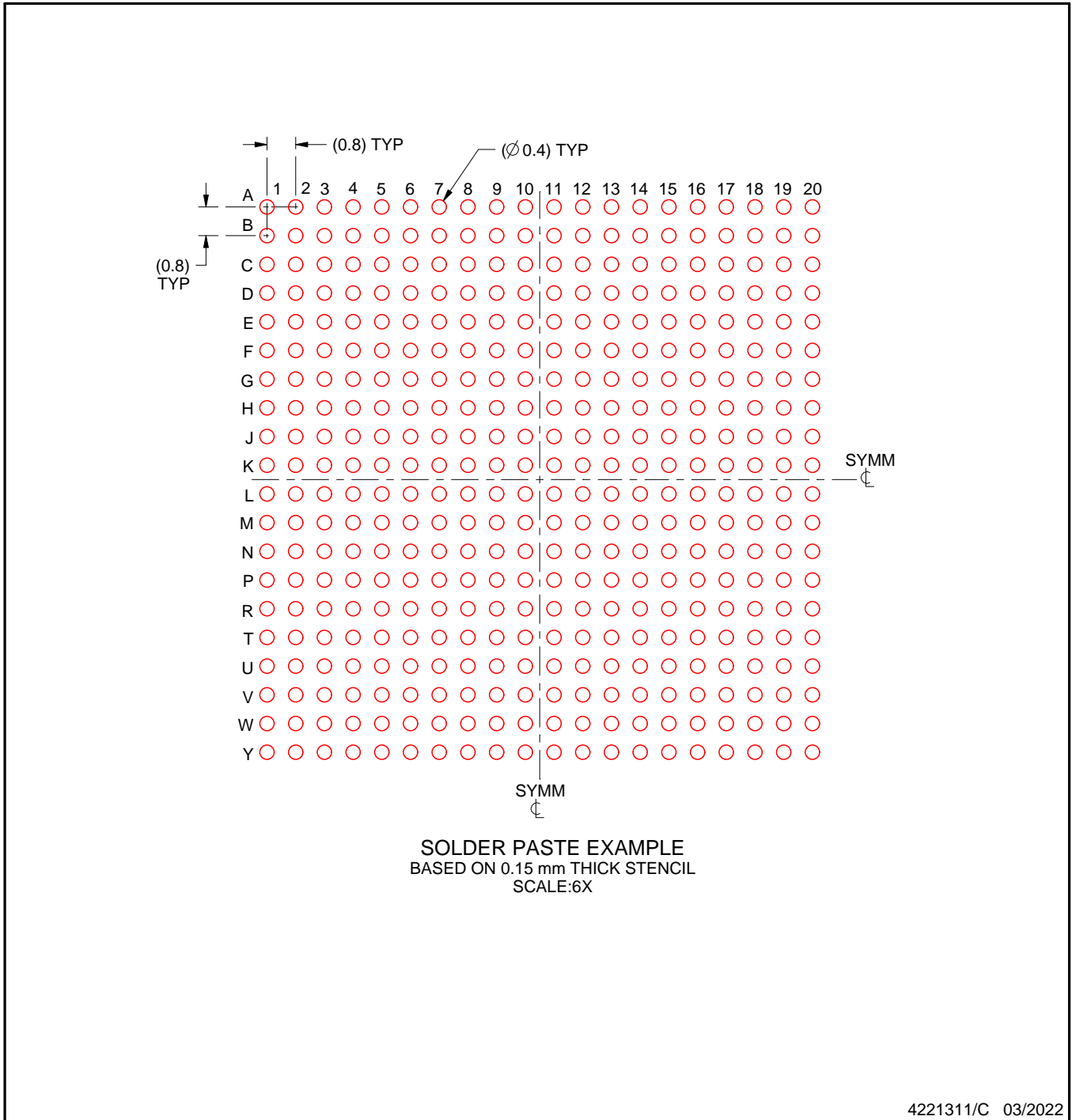

NOTES: (continued)

6. Laser cutting apertures with trapezoidal walls and rounded corners may offer better paste release.

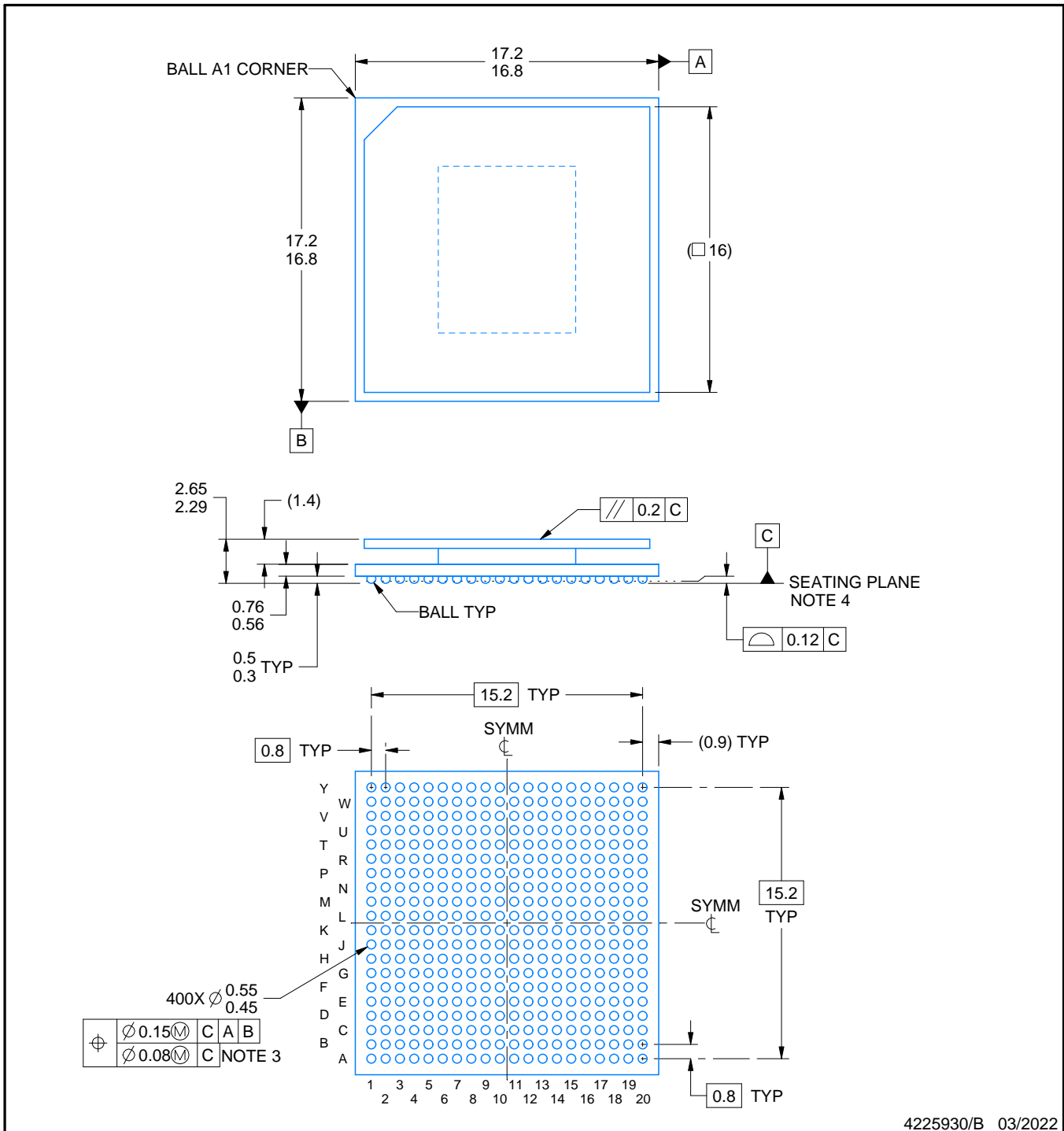
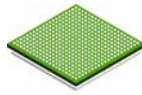

4225930/B 03/2022

NOTES:

1. All linear dimensions are in millimeters. Any dimensions in parenthesis are for reference only. Dimensioning and tolerancing per ASME Y14.5M.
2. This drawing is subject to change without notice.
3. Dimension is measured at the maximum solder ball diameter, parallel to primary datum C.
4. Primary datum C and seating plane are defined by the spherical crowns of the solder balls.
5. Pb-Free die bump and SnPb solder ball.

EXAMPLE BOARD LAYOUT

ALK0400A

FCBGA - 2.65 mm max height

BALL GRID ARRAY

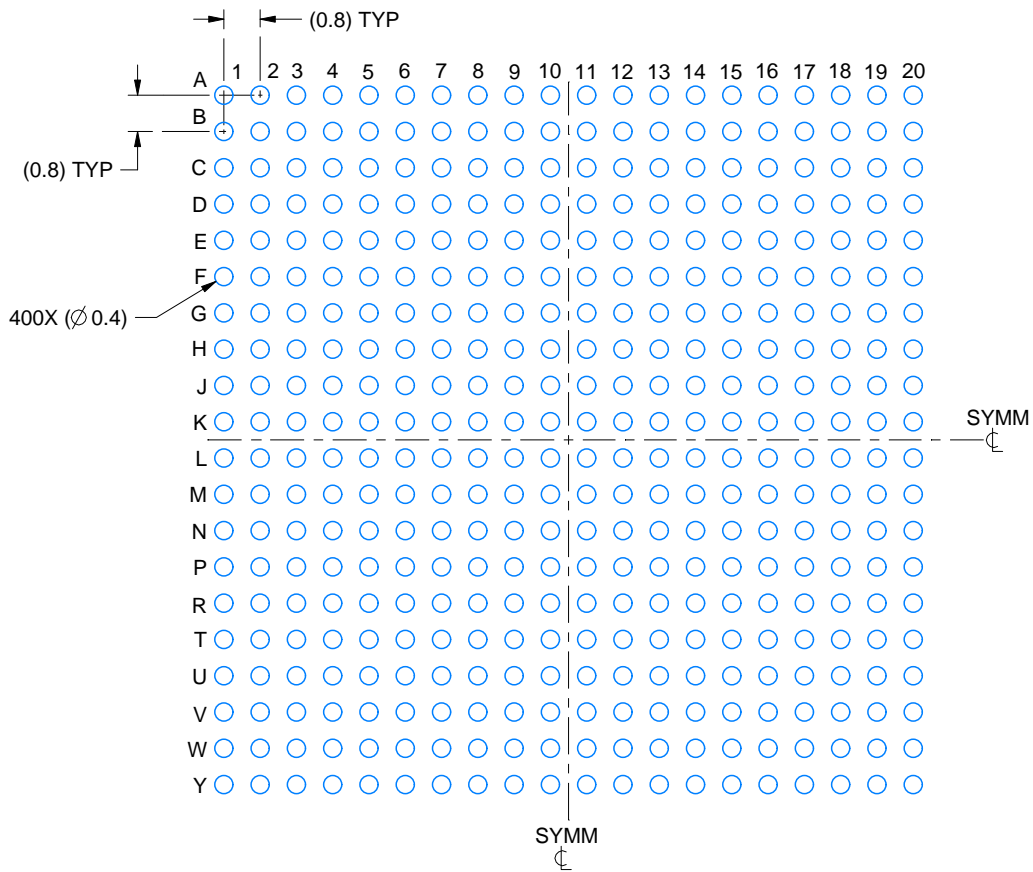

LAND PATTERN EXAMPLE
EXPOSED METAL SHOWN
SCALE:6X

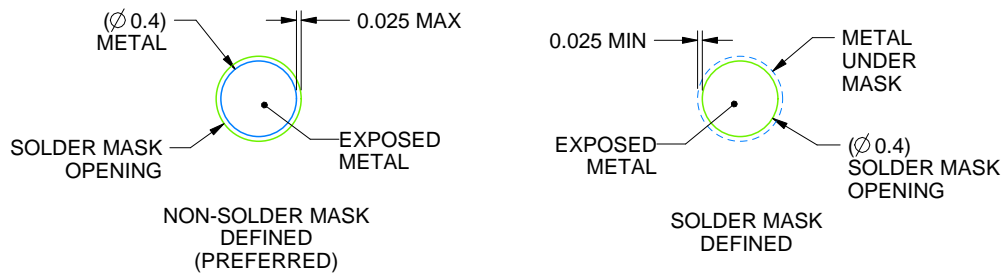

SOLDER MASK DETAILS
NOT TO SCALE

4225930/B 03/2022

NOTES: (continued)

- Final dimensions may vary due to manufacturing tolerance considerations and also routing constraints. For more information, see Texas Instruments literature number SPRU811 (www.ti.com/lit/spru811).

EXAMPLE STENCIL DESIGN

ALK0400A

FCBGA - 2.65 mm max height

BALL GRID ARRAY

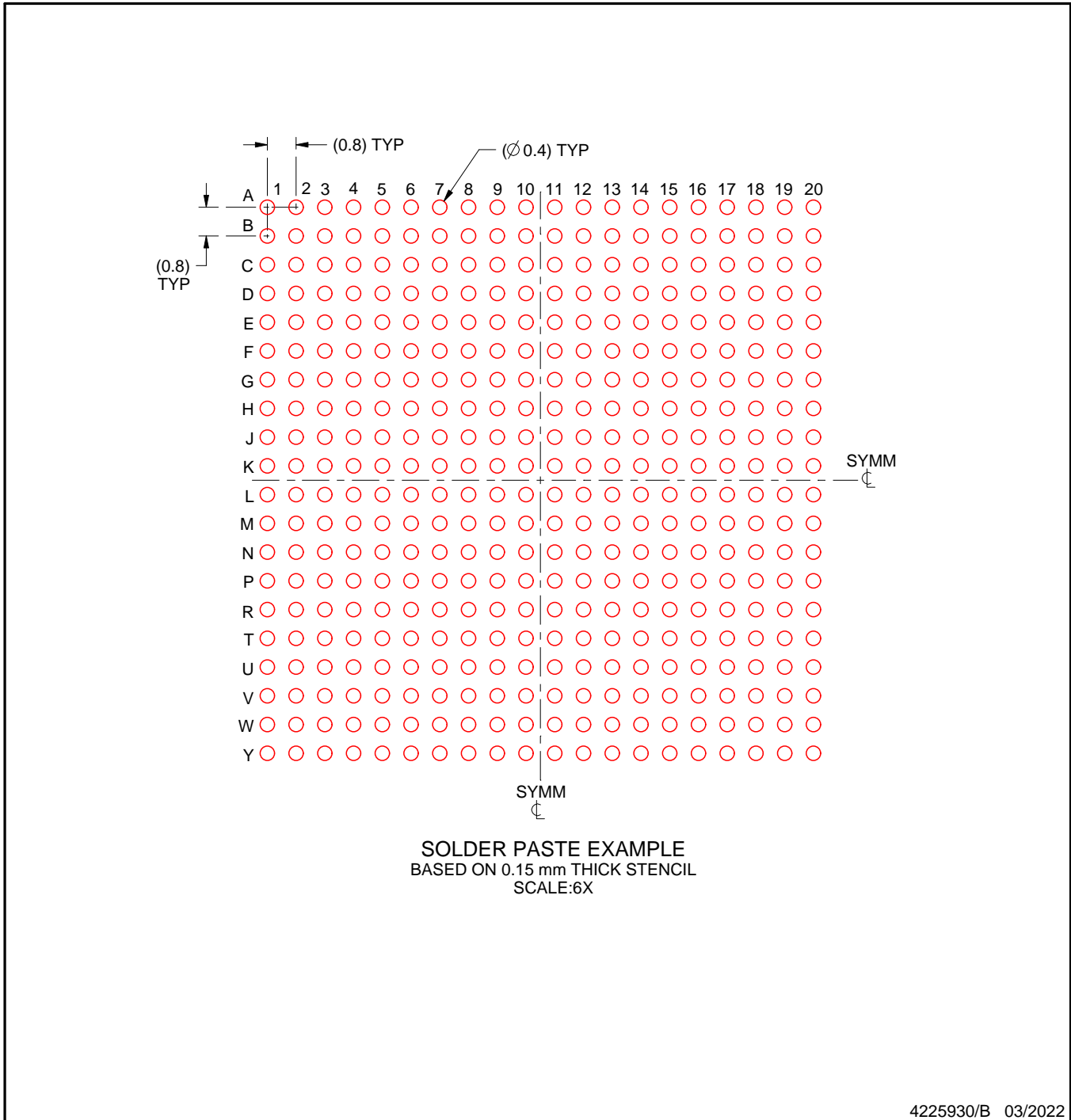

NOTES: (continued)

7. Laser cutting apertures with trapezoidal walls and rounded corners may offer better paste release.

IMPORTANT NOTICE AND DISCLAIMER

TI PROVIDES TECHNICAL AND RELIABILITY DATA (INCLUDING DATA SHEETS), DESIGN RESOURCES (INCLUDING REFERENCE DESIGNS), APPLICATION OR OTHER DESIGN ADVICE, WEB TOOLS, SAFETY INFORMATION, AND OTHER RESOURCES "AS IS" AND WITH ALL FAULTS, AND DISCLAIMS ALL WARRANTIES, EXPRESS AND IMPLIED, INCLUDING WITHOUT LIMITATION ANY IMPLIED WARRANTIES OF MERCHANTABILITY, FITNESS FOR A PARTICULAR PURPOSE OR NON-INFRINGEMENT OF THIRD PARTY INTELLECTUAL PROPERTY RIGHTS.

These resources are intended for skilled developers designing with TI products. You are solely responsible for (1) selecting the appropriate TI products for your application, (2) designing, validating and testing your application, and (3) ensuring your application meets applicable standards, and any other safety, security, regulatory or other requirements.

These resources are subject to change without notice. TI grants you permission to use these resources only for development of an application that uses the TI products described in the resource. Other reproduction and display of these resources is prohibited. No license is granted to any other TI intellectual property right or to any third party intellectual property right. TI disclaims responsibility for, and you will fully indemnify TI and its representatives against, any claims, damages, costs, losses, and liabilities arising out of your use of these resources.

TI's products are provided subject to [TI's Terms of Sale](#) or other applicable terms available either on [ti.com](https://www.ti.com) or provided in conjunction with such TI products. TI's provision of these resources does not expand or otherwise alter TI's applicable warranties or warranty disclaimers for TI products.

TI objects to and rejects any additional or different terms you may have proposed.

Mailing Address: Texas Instruments, Post Office Box 655303, Dallas, Texas 75265
Copyright © 2023, Texas Instruments Incorporated