

## High Performance Schottky Rectifier, 100 A



PowerTab®



### FEATURES

- 150 °C max. operating junction temperature
- High frequency operation
- Ultralow forward voltage drop
- Continuous high current operation
- Guard ring for enhanced ruggedness and long term reliability
- Screw mounting only
- AEC-Q101 qualified
- PowerTab® package
- Material categorization: for definitions of compliance please see [www.vishay.com/doc?99912](http://www.vishay.com/doc?99912)

**RoHS**  
COMPLIANT

### PRODUCT SUMMARY

Package	PowerTab®
$I_{F(AV)}$	100 A
$V_R$	30 V
$V_F$ at $I_F$	0.56 V
$I_{RM}$	460 mA at 125 °C
$T_J$ max.	150 °C
Diode variation	Single die
$E_{AS}$	9 mJ

### DESCRIPTION

The VS-100BGQ030HF4 Schottky rectifier has been optimized for ultralow forward voltage drop specifically for low voltage output in high current AC/DC power supplies. The proprietary barrier technology allows for reliable operation up to 150 °C junction temperature. Typical applications are in switching power supplies, converters, reverse battery protection, and redundant power subsystems.

### MAJOR RATINGS AND CHARACTERISTICS

SYMBOL	CHARACTERISTICS	VALUES	UNITS
$I_{F(AV)}$	Rectangular waveform	100	A
	$T_C$	106	°C
$V_{RRM}$		30	V
$I_{FSM}$	$t_p = 5 \mu s$ sine	4500	A
$V_F$	100 A <sub>pk</sub> (typical)	0.49	V
	$T_J$	150	°C
$T_J$	Range	-55 to +150	°C

### VOLTAGE RATINGS

PARAMETER	SYMBOL	VS-100BGQ030HF4	UNITS
Maximum DC reverse voltage	$V_R$	30	V
Maximum working peak reverse voltage	$V_{RWM}$		

### ABSOLUTE MAXIMUM RATINGS

PARAMETER	SYMBOL	TEST CONDITIONS	VALUES	UNITS
Maximum average forward current	$I_{F(AV)}$	50 % duty cycle at $T_C = 106$ °C, rectangular waveform	100	A
Maximum peak one cycle non-repetitive surge current	$I_{FSM}$	5 $\mu s$ sine or 3 $\mu s$ rect. pulse	4500	A
		10 ms sine or 6 ms rect. pulse		
Non-repetitive avalanche energy	$E_{AS}$	$T_J = 25$ °C, $I_{AS} = 8$ A, $L = 1.12$ mH	36	mJ
Repetitive avalanche current	$I_{AR}$	Current decaying linearly to zero in 1 $\mu s$ Frequency limited by $T_J$ maximum $V_A = 1.5 \times V_R$ typical	8	A

ELECTRICAL SPECIFICATIONS						
PARAMETER	SYMBOL	TEST CONDITIONS		TYP.	MAX.	UNITS
Forward voltage drop	$V_{FM}^{(1)}$	50 A	$T_J = 25\text{ }^\circ\text{C}$	0.47	0.5	V
		100 A		0.56	0.63	
		50 A	$T_J = 150\text{ }^\circ\text{C}$	0.36	0.4	
		100 A		0.49	0.56	
Reverse leakage current	$I_{RM}^{(1)}$	$T_J = 125\text{ }^\circ\text{C}, V_R = 15\text{ V}$		80	160	mA
		$T_J = 150\text{ }^\circ\text{C}, V_R = 30\text{ V}$		800	1100	
		$T_J = 25\text{ }^\circ\text{C}$	$V_R = \text{Rated } V_R$	0.6	2.4	
		$T_J = 125\text{ }^\circ\text{C}$		260	460	
Maximum junction capacitance	$C_T$	$V_R = 5 V_{DC}$ , (test signal range 100 kHz to 1 MHz) $25\text{ }^\circ\text{C}$		3800		pF
Typical series inductance	$L_S$	Measured from tab to mounting plane		3.5		nH
Maximum voltage rate of change	$dV/dt$	Rated $V_R$		10 000		V/ $\mu\text{s}$

**Note**

 (1) Pulse width < 300  $\mu\text{s}$ , duty cycle < 2 %

THERMAL - MECHANICAL SPECIFICATIONS				
PARAMETER	SYMBOL	TEST CONDITIONS	VALUES	UNITS
Maximum junction and storage temperature range	$T_J, T_{Stg}$		-55 to +150	$^\circ\text{C}$
Maximum thermal resistance, junction to case	$R_{thJC}$	DC operation	0.50	$^\circ\text{C/W}$
Typical thermal resistance, case to heatsink	$R_{thCS}$	Mounting surface, smooth and greased	0.30	
Approximate weight			5	g
			0.18	oz.
Mounting torque	minimum		1.2 (10)	N · m (lbf · in)
	maximum		2.4 (20)	
Marking device		Case style PowerTab®	100BGQ030H	

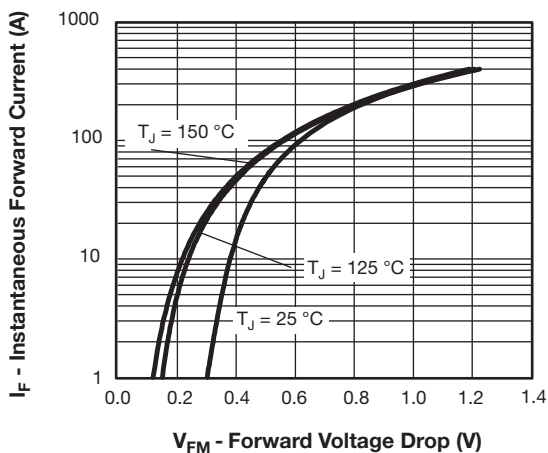

Fig. 1 - Maximum Forward Voltage Drop Characteristics

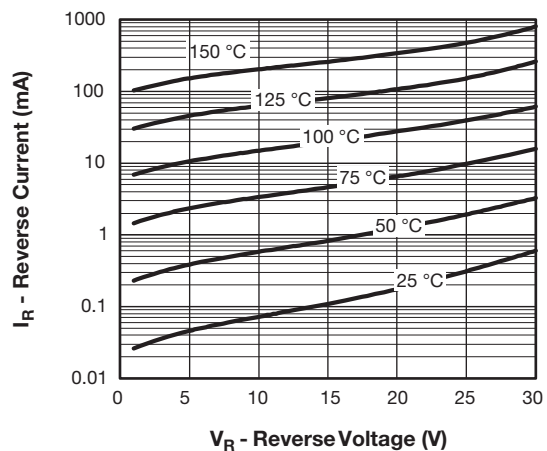

Fig. 2 - Typical Values of Reverse Current vs. Reverse Voltage

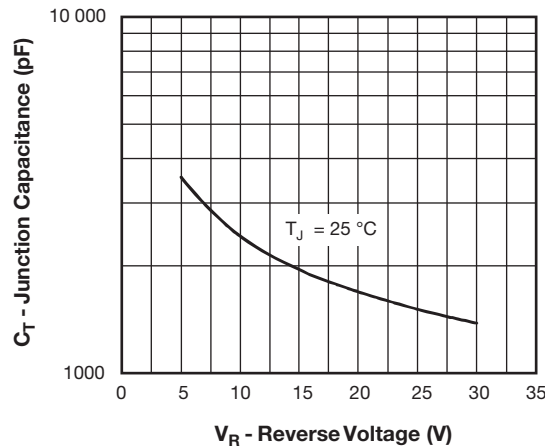

Fig. 3 - Typical Junction Capacitance vs. Reverse Voltage

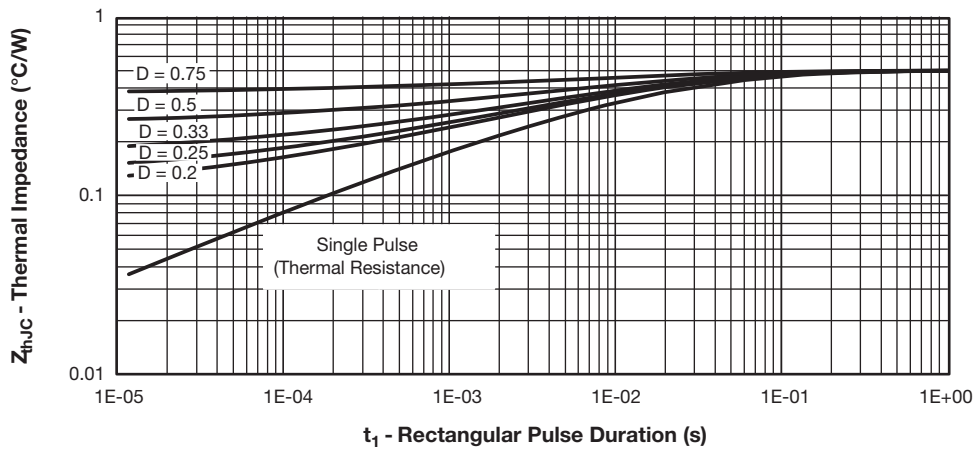

Fig. 4 - Maximum Thermal Impedance  $Z_{thJC}$  Characteristics

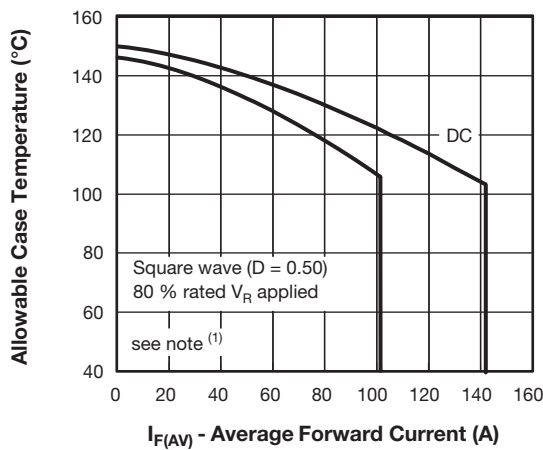

Fig. 5 - Maximum Allowable Case Temperature vs. Average Forward Current

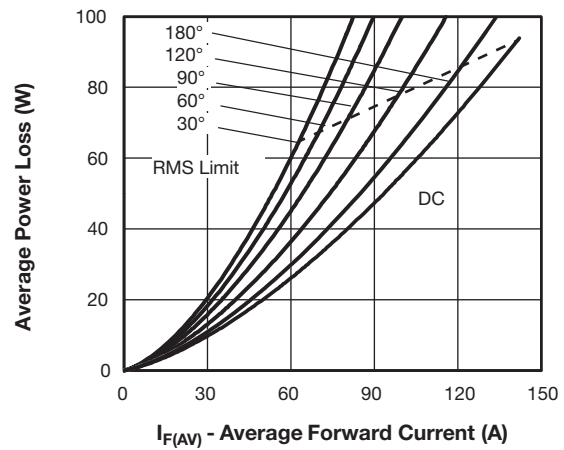

Fig. 6 - Forward Power Loss Characteristics

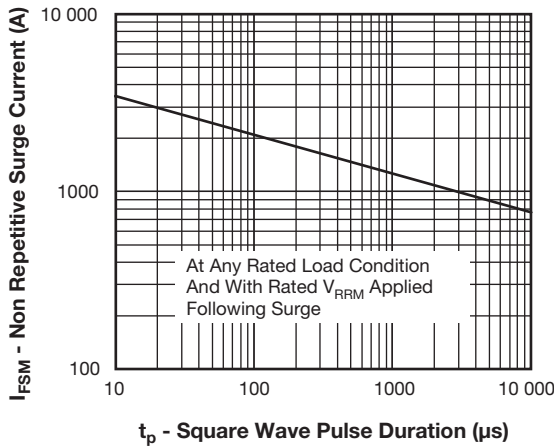

Fig. 7 - Maximum Non-Repetitive Surge Current

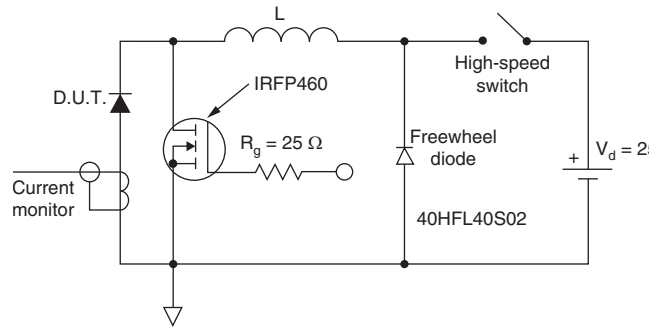

Fig. 8 - Unclamped Inductive Test Circuit

**Note**

(1) Formula used:  $T_C = T_J - (P_d + P_{dREV}) \times R_{thJC}$ ;  
 $P_d$  = Forward power loss =  $I_{F(AV)} \times V_{FM}$  at  $(I_{F(AV)}/D)$  (see fig. 6);  
 $P_{dREV}$  = Inverse power loss =  $V_{R1} \times I_R (1 - D)$ ;  $I_R$  at  $V_{R1} = 80\%$  rated  $V_R$

**ORDERING INFORMATION TABLE**

Device code	<b>VS-</b>	<b>100</b>	<b>BGQ</b>	<b>030</b>	<b>H</b>	<b>F4</b>
	①	②	③	④	⑤	⑥
	1	2	3	4	5	6

- 1 - Vishay Semiconductors product
- 2 - Current rating (100 = 100 A)
- 3 - Essential part number
- 4 - Voltage rating (030 = 30 V)
- 5 - H = AEC-Q101 qualified
- 6 - Environmental digit:
- F4 = RoHS compliant and totally lead (Pb)-free

ORDERING INFORMATION (Example)			
PREFERRED P/N	QUANTITY PER T/R	MINIMUM ORDER QUANTITY	PACKAGING DESCRIPTION
VS-100BGQ030HF4	25	375	Antistatic plastic tube

LINKS TO RELATED DOCUMENTS	
Dimensions	<a href="http://www.vishay.com/doc?95240">www.vishay.com/doc?95240</a>
Part marking information	<a href="http://www.vishay.com/doc?95467">www.vishay.com/doc?95467</a>
Application note	<a href="http://www.vishay.com/doc?95179">www.vishay.com/doc?95179</a>



### PowerTab®

#### DIMENSIONS in millimeters (inches)



**Note:**  
Outline conform to JEDEC® TO-275, except for dimension "G" only



## Disclaimer

ALL PRODUCT, PRODUCT SPECIFICATIONS AND DATA ARE SUBJECT TO CHANGE WITHOUT NOTICE TO IMPROVE RELIABILITY, FUNCTION OR DESIGN OR OTHERWISE.

Vishay Intertechnology, Inc., its affiliates, agents, and employees, and all persons acting on its or their behalf (collectively, "Vishay"), disclaim any and all liability for any errors, inaccuracies or incompleteness contained in any datasheet or in any other disclosure relating to any product.

Vishay makes no warranty, representation or guarantee regarding the suitability of the products for any particular purpose or the continuing production of any product. To the maximum extent permitted by applicable law, Vishay disclaims (i) any and all liability arising out of the application or use of any product, (ii) any and all liability, including without limitation special, consequential or incidental damages, and (iii) any and all implied warranties, including warranties of fitness for particular purpose, non-infringement and merchantability.

Statements regarding the suitability of products for certain types of applications are based on Vishay's knowledge of typical requirements that are often placed on Vishay products in generic applications. Such statements are not binding statements about the suitability of products for a particular application. It is the customer's responsibility to validate that a particular product with the properties described in the product specification is suitable for use in a particular application. Parameters provided in datasheets and / or specifications may vary in different applications and performance may vary over time. All operating parameters, including typical parameters, must be validated for each customer application by the customer's technical experts. Product specifications do not expand or otherwise modify Vishay's terms and conditions of purchase, including but not limited to the warranty expressed therein.

Hyperlinks included in this datasheet may direct users to third-party websites. These links are provided as a convenience and for informational purposes only. Inclusion of these hyperlinks does not constitute an endorsement or an approval by Vishay of any of the products, services or opinions of the corporation, organization or individual associated with the third-party website. Vishay disclaims any and all liability and bears no responsibility for the accuracy, legality or content of the third-party website or for that of subsequent links.

Except as expressly indicated in writing, Vishay products are not designed for use in medical, life-saving, or life-sustaining applications or for any other application in which the failure of the Vishay product could result in personal injury or death. Customers using or selling Vishay products not expressly indicated for use in such applications do so at their own risk. Please contact authorized Vishay personnel to obtain written terms and conditions regarding products designed for such applications.

No license, express or implied, by estoppel or otherwise, to any intellectual property rights is granted by this document or by any conduct of Vishay. Product names and markings noted herein may be trademarks of their respective owners.