

Universal current transducer - MCR-SL-CUC-300-I - 2308043

Please be informed that the data shown in this PDF Document is generated from our Online Catalog. Please find the complete data in the user's documentation. Our General Terms of Use for Downloads are valid (<http://phoenixcontact.com/download>)

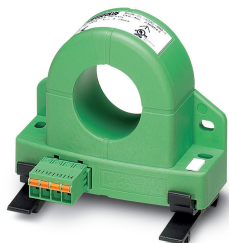

Universal current transducer, for measuring AC, DC, and distorted currents, 0 ... 300 A input current, 4 ... 20 mA output

Your advantages

- ✓ Variable mounting on DIN rail and mounting plate
- ✓ Compact dimensions also enable distributed use
- ✓ Simple connection technology thanks to COMBICON plug-in connection terminal blocks
- ✓ 3-way isolation
- ✓ Universal current measurement, no shunt required



Key Commercial Data

| | |
|--------------|---|
| Packing unit | 1 pc |
| GTIN |  4 046356 434041 |
| GTIN | 4046356434041 |

Technical data

Dimensions

| | |
|--------|---------|
| Width | 90 mm |
| Height | 33.8 mm |
| Depth | 85 mm |

Ambient conditions

| | |
|---|------------------|
| Ambient temperature (operation) | -40 °C ... 65 °C |
| Ambient temperature (storage/transport) | -40 °C ... 85 °C |
| Degree of protection | IP20 |
| Noise immunity | EN 61000-6-2 |

Input data

| | |
|------------------|---|
| Number of inputs | 1 |
|------------------|---|

Universal current transducer - MCR-SL-CUC-300-I - 2308043

Technical data

Input data

| | |
|---------------------------------------|------------------------------|
| Input current range | 0 A ... 300 A |
| Overload capacity | 3.33 x I _{IN} |
| Frequency measuring range | 20 Hz ... 6000 Hz (0 Hz) |
| Connection method | Cable design: 32 mm diameter |
| Rated frequency: Standard converter | 20 Hz ... 6000 Hz |
| Primary rated current I _{pn} | 300 A |

Output data

| | |
|---------------------------------|----------------|
| Output name | Current output |
| Current output signal | 4 mA ... 20 mA |
| Max. output current | < 25 mA |
| Load/output load current output | < 300 Ω |

Switching output

| | |
|-------------|---------------------|
| Output name | No switching output |
|-------------|---------------------|

Power supply

| | |
|--------------------------|-----------------------------|
| Nominal supply voltage | 24 V DC |
| Supply voltage range | 20 V DC ... 30 V DC |
| Max. current consumption | (30 + I _{OUT}) mA |
| Power consumption | 1.65 W |

Connection data

| | |
|----------------------------------|--|
| Connection method | Push-in connection |
| Stripping length | 10 mm |
| Conductor cross section solid | 0.25 mm ² ... 2.5 mm ² |
| Conductor cross section flexible | 0.2 mm ² ... 2.5 mm ² |
| Conductor cross section AWG | 24 ... 12 |

General

| | |
|----------------------------------|--|
| Accuracy class | 1 |
| Maximum transmission error | <± 1 % (of final value) |
| Temperature coefficient, typical | 0.02 %/K (0 °C ... 60 °C) 0.04 %/K (-40 °C ... 65 °C) |
| Linearity error | <± 1 % (From the range end value) |
| Step response (10-90%) | 150 ms |
| Overvoltage category | III |
| Degree of pollution | 2 |
| Rated insulation voltage | 300 V AC |
| Test voltage input/output | 3.5 kV (50 Hz, 1 min.) |
| Test voltage input/power supply | 3.5 kV (50 Hz, 1 min.) |
| Noise emission | EN 61000-6-4 |
| Noise immunity | EN 61000-6-2 |

Universal current transducer - MCR-SL-CUC-300-I - 2308043

Technical data

General

| | |
|------------------|--------------------|
| Color | green |
| Housing material | Franyl B63 V0 GV30 |

Standards and Regulations

| | |
|----------------|--------------|
| Noise emission | EN 61000-6-4 |
| Noise immunity | EN 61000-6-2 |

Conformance/approvals

| | |
|----------------|-----------------------|
| Designation | CE |
| Certificate | CE-compliant |
| Designation | UL, USA/Canada |
| Identification | UL/C-UL Listed UL 508 |

Environmental Product Compliance

| | |
|------------|---|
| China RoHS | Environmentally Friendly Use Period = 25; |
| | For details about hazardous substances go to tab "Downloads", Category "Manufacturer's declaration" |

Drawings

Dimensional drawing

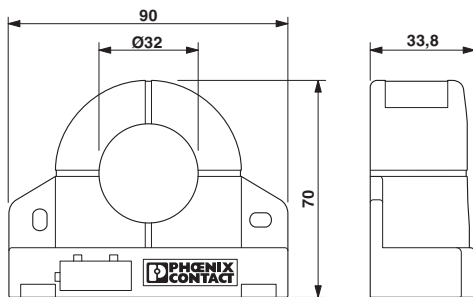

Circuit diagram

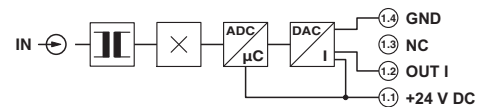

Universal current transducer - MCR-SL-CUC-300-I - 2308043

Schematic diagram

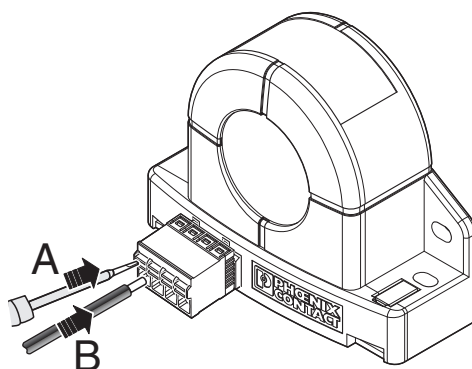

Classifications

eCl@ss

| | |
|---------------|----------|
| eCl@ss 10.0.1 | 27210902 |
| eCl@ss 11.0 | 27210902 |
| eCl@ss 4.0 | 27210900 |
| eCl@ss 4.1 | 27210900 |
| eCl@ss 5.0 | 27210900 |
| eCl@ss 5.1 | 27210900 |
| eCl@ss 6.0 | 27210900 |
| eCl@ss 7.0 | 27210902 |
| eCl@ss 9.0 | 27210902 |

ETIM

| | |
|----------|----------|
| ETIM 3.0 | EC002048 |
| ETIM 4.0 | EC002048 |
| ETIM 6.0 | EC002048 |
| ETIM 7.0 | EC002048 |

UNSPSC

| | |
|---------------|----------|
| UNSPSC 6.01 | 30211504 |
| UNSPSC 7.0901 | 39121006 |
| UNSPSC 11 | 39121006 |
| UNSPSC 12.01 | 39121006 |
| UNSPSC 13.2 | 39121032 |
| UNSPSC 18.0 | 39121032 |
| UNSPSC 19.0 | 39121032 |
| UNSPSC 20.0 | 39121032 |
| UNSPSC 21.0 | 39121032 |

Universal current transducer - MCR-SL-CUC-300-I - 2308043

Approvals





Approvals

Approvals

UL Listed / cUL Listed / EAC / cULus Listed

Ex Approvals

Approval details

| | | | |
|--------------|---|---|----------------------|
| UL Listed |  | http://database.ul.com/cgi-bin/XYV/template/LISEXT/1FRAME/index.htm | FILE E 123528 |
| cUL Listed |  | http://database.ul.com/cgi-bin/XYV/template/LISEXT/1FRAME/index.htm | FILE E 123528 |
| EAC |  | | RU*DE.*08.B.01852-19 |
| cULus Listed |  | | |

Phoenix Contact 2021 © - all rights reserved
<http://www.phoenixcontact.com>

PHOENIX CONTACT GmbH & Co. KG
Flachsmarktstr. 8
32825 Blomberg
Germany
Tel. +49 5235 300
Fax +49 5235 3 41200
<http://www.phoenixcontact.com>