

LINOS F-Theta-Ronar Lens

f = 250mm, 532nm

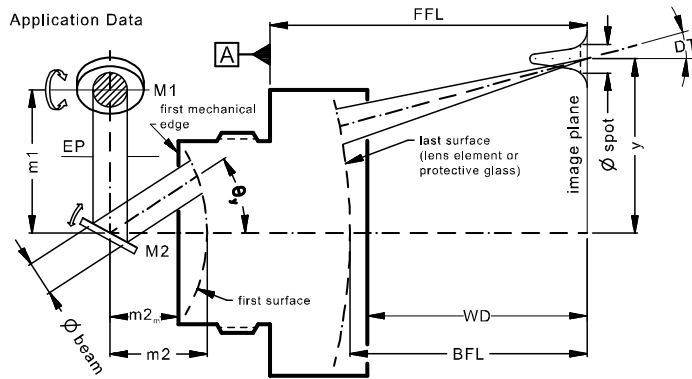

Part number	4401-289-000-20		
Design wavelength	λ	(nm)	532
Effective focal length	EFL	(mm)	250.2
Back focal length	BFL	(mm)	291.4
Working distance	WD	(mm)	288.5
Flange focal length	FFL	(mm)	337.1
Beam diameter 1/e ² truncated	$\varnothing_{\text{beam}}$	(mm)	20.0
Recommended mirror distance m1	m1	(mm)	22.0
Recommended mirror distance m2	m2	(mm)	24.0
Recommended mirror distance m2 _{mechanical}	m2 _m	(mm)	19.5
Scan angle	$\pm\theta_{x,y}$	(°)	17.7
Scan area (edge length of scan field)	2x * 2y	(mm ²)	154 x 154
Spot diameter	$\varnothing_{\text{spot}}$	(μm)	12
Total transmission @ 532nm	T	(%)	> 96
LIDT coating @ 532nm, 6ns, 100Hz		(J/cm ²)	6
Focused back reflex positions from first surface		(mm)	14.0; 19.3; 52.8; 70.6; 71.3; 131.6; 314.2
Weight		(g)	1220
Protective glass	PG		4401-289-007-00

Optical parameters calculated for a 1-mirror system
 Subject to technical change

Mechanical drawing

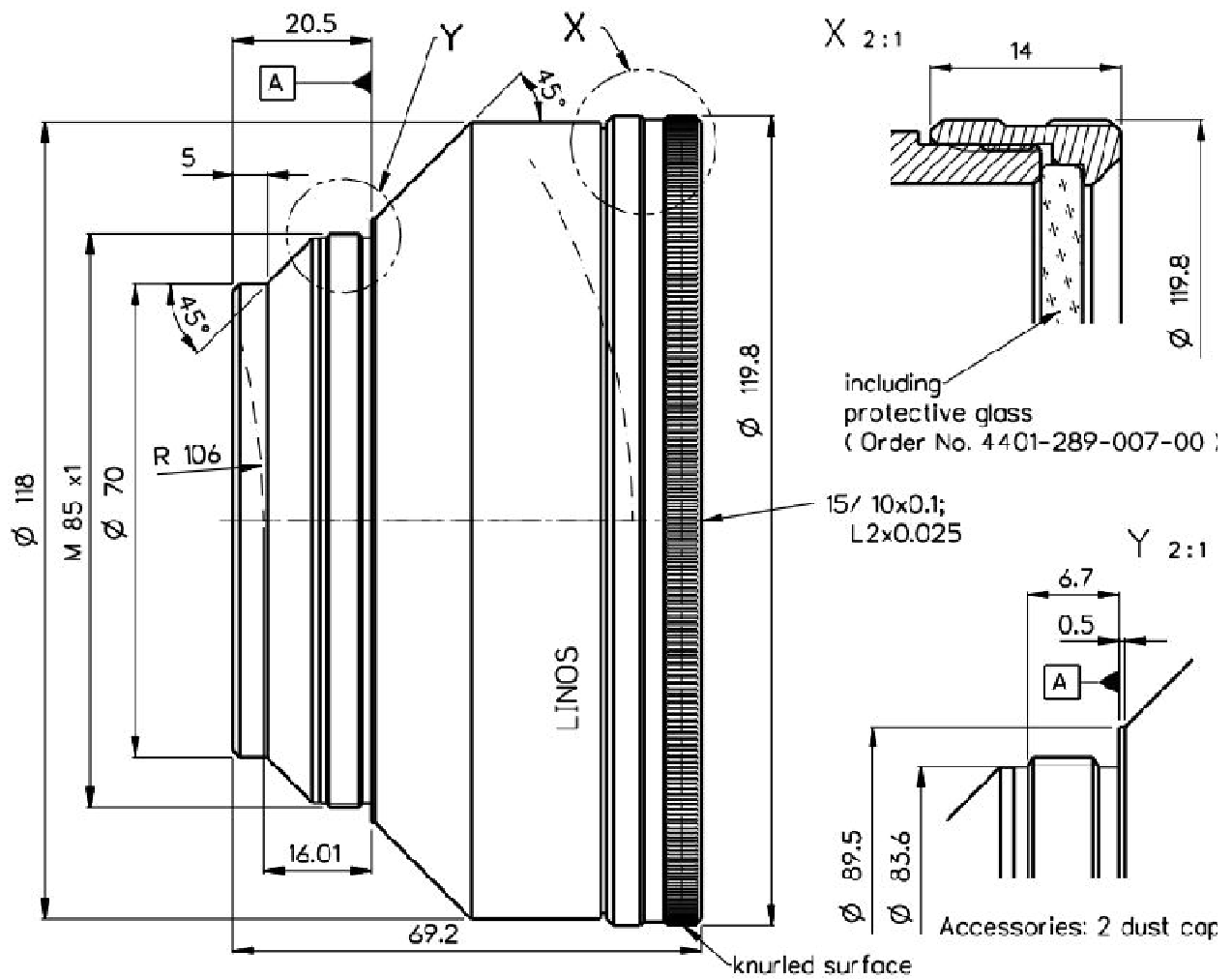

Dimensions without tolerances are nominal values and illustration not to scale

Notes



For technical explanations, see our homepage.

In a 1-mirror system, the entrance pupil (EP) is the position of the scan mirror. In a 2-mirror system, it is the point where the scan mirrors should be placed around symmetrically to reach specified performance.