

- Steep Roll-off Filter for 915 MHz ISM band
- Differential Input / Single-ended Output
- Complies with Directive 2002/95/EC (RoHS)
- AEC-Q200 Qualified
- Moisture Sensitivity Level: 1

RoHS
Compliant

SF2093E

915.00 MHz
SAW Filter

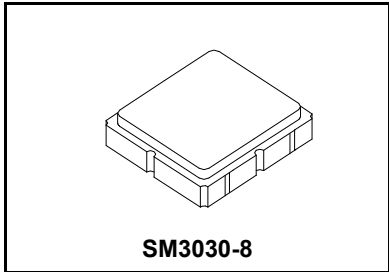

Absolute Maximum Ratings

Rating	Value	Units
Input Power Level	+15	dBm
DC Voltage on any Non-ground Terminal	3	V
Operating Temperature Range	-30 to +85	°C
Storage Temperature Range in Tape and Reel	-40 to +85	°C
Suitable for Lead-free Soldering - Maximum Soldering Profile	260°C for 30 s	

Electrical Characteristics

Characteristic	Sym	Notes	Min	Typ	Max	Units
Center Frequency	f_c			915.00		MHz
Insertion Loss, 902 to 928 MHz	IL			2.5	3.5	dB
Amplitude Ripple, p-p, 902 to 928 MHz				0.5	2.0	
VSWR, 902 to 928 MHz				1.75	2.4	
Attenuation Referenced to 0 dB:						
DC to 800 MHz			40	54		
850 to 870 MHz			35	54		
960 to 1035 MHz			28	36		
1035 to 1500 MHz			40	57		
1500 to 3000 MHz			30	56		
Source Impedance	Z_S			800		Ω
Load Impedance	Z_L			50		Ω

Case Style	SM3030-8 3.0 x 3.0 mm Nominal Footprint		
Lid Symbolization (Y=year, WW=week, S=shift) dot=pin 1 indicator	582, YWWS		
Standard Reel Quantity	Reel Size 7 Inch	500 Pieces/Reel	
	Reel Size 13 Inch	3000 Pieces/Reel	

Electrical Connections

Connection	Terminals
Input, Balanced	1, 3
Output, Single Ended	6
Case Ground	All others

CAUTION: Electrostatic Sensitive Device. Observe precautions for handling.
NOTES:

1. The design, manufacturing process, and specifications of this device are subject to change.
2. US or International patents may apply.
3. RoHS compliant from the first date of manufacture.

SF2093E Filter Response Plots

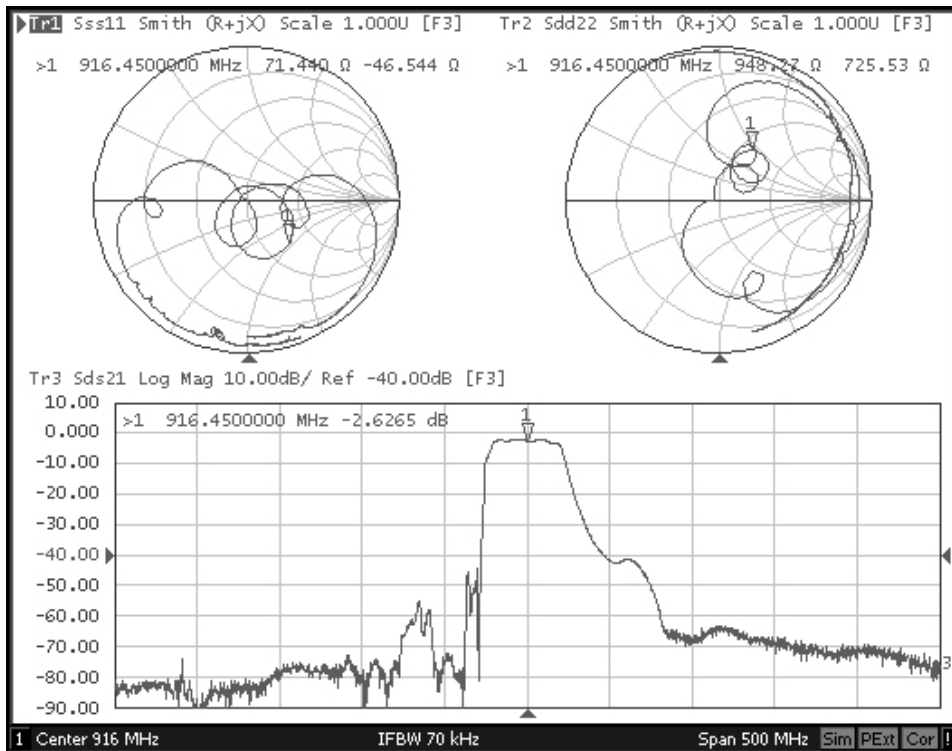

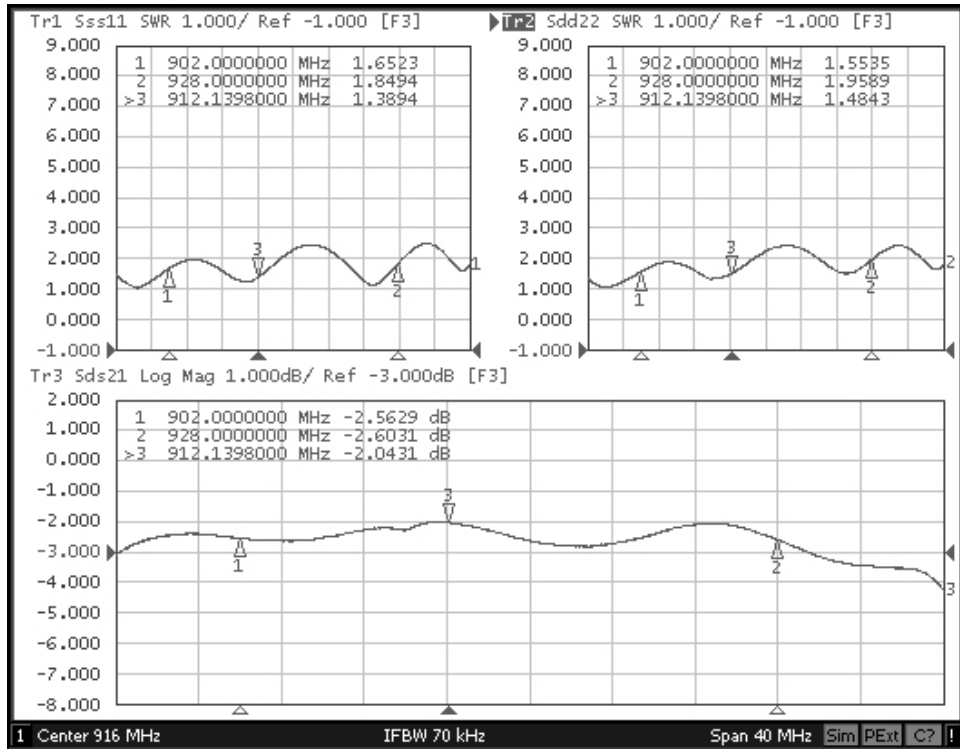

D. MEASUREMENT CIRCUIT:

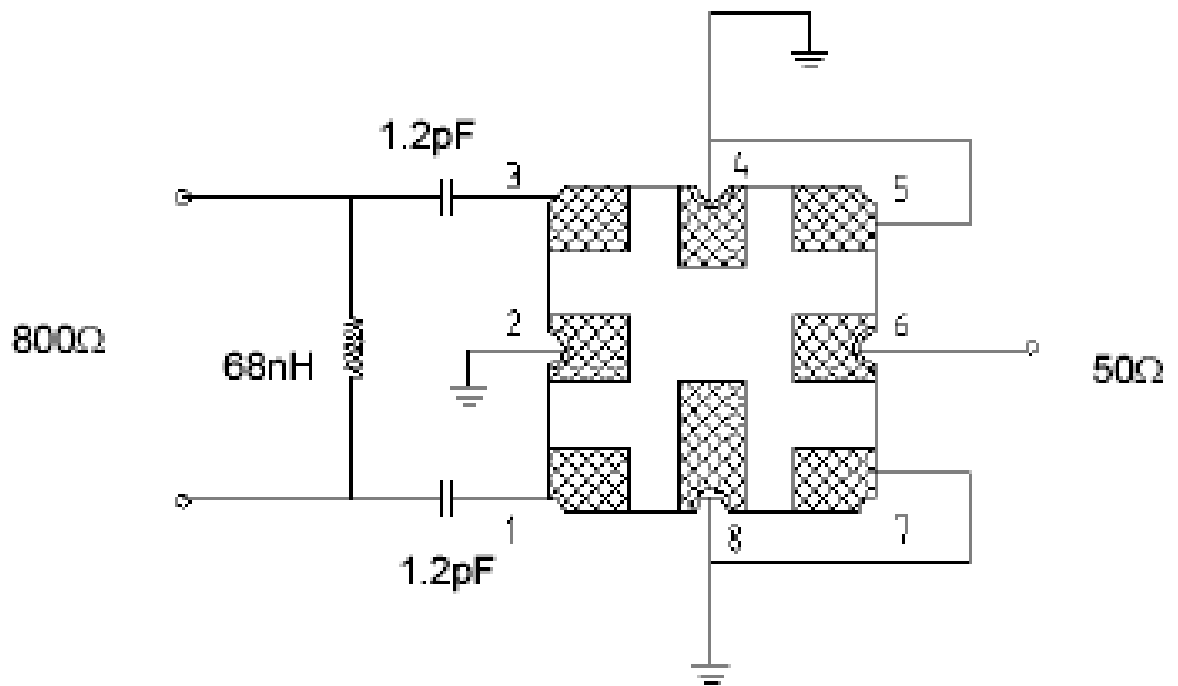

8-Terminal Ceramic Surface-Mount Case 3.0 X 3.0 mm Nominal Footprint

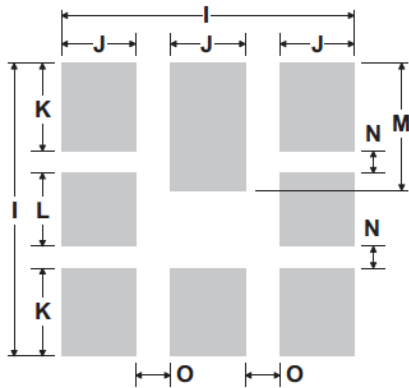
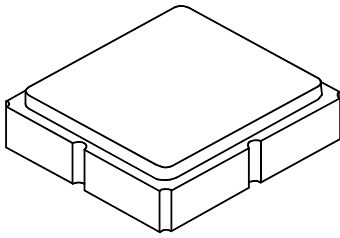

PCB Footprint Top View

Case and PCB Footprint Dimensions

Dimension	mm			Inches		
	Min	Nom	Max	Min	Nom	Max
A	2.87	3.0	3.13	0.113	0.118	0.123
B	2.87	3.0	3.13	0.113	0.118	0.123
C	1.14	1.27	1.40	0.045	0.050	0.055
D	0.79	0.92	1.05	0.031	0.036	0.041
E	0.62	0.75	0.88	0.024	0.029	0.034
F	0.47	0.60	0.73	0.018	0.024	0.029
G	0.47	0.60	0.73	0.018	0.024	0.029
H	1.07	1.20	1.33	0.042	0.047	0.052
I		3.19			0.126	
J		0.81			0.032	
K		0.96			0.038	
L		0.81			0.032	
M		1.39			0.055	
N		0.23			0.009	
O		0.38			0.015	

Case Materials

Materials	
Solder Pad Plating	0.3 to 1.0 μm Gold over 1.27 to 8.89 μm Nickel
Lid Plating	2.0 to 3.0 μm Nickel
Body	Al_2O_3 Ceramic
Pb Free	

TOP VIEW

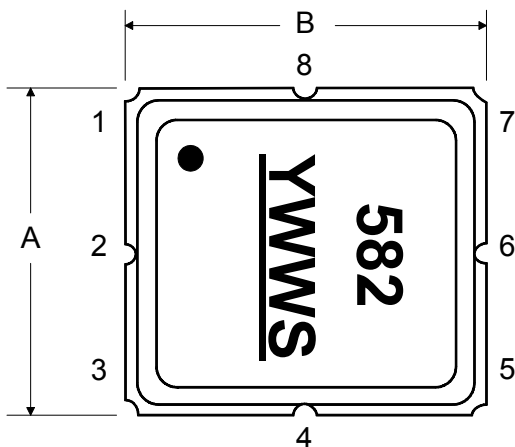

BOTTOM VIEW

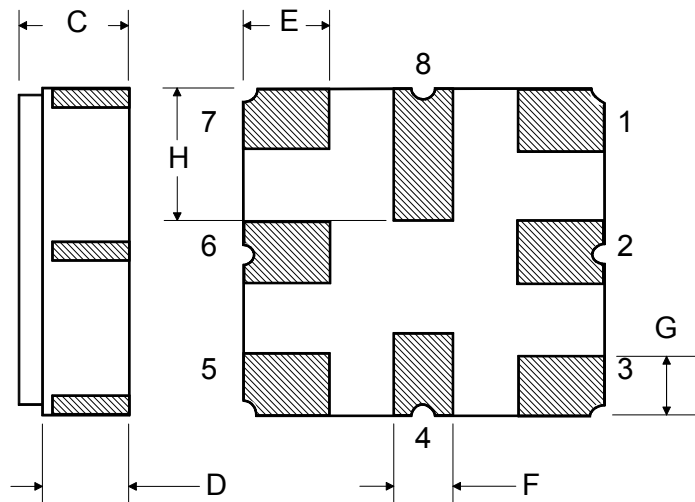

Tape and Reel Specifications

Tape and Reel Standard per ANSI/EIA-481

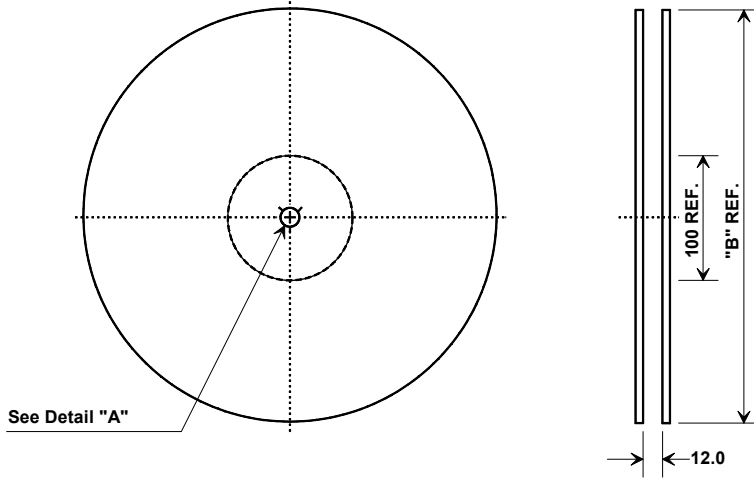

"B"		Quantity Per Reel
Inches	millimeters	
7	178	500
13	330	3000

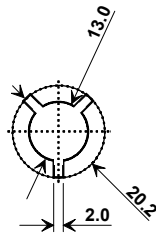

Carrier Tape Dimensions	
Ao	3.35 mm
Bo	3.35 mm
Ko	1.40 mm
Pitch	8.0 mm
W	12.0 mm

COMPONENT ORIENTATION and DIMENSIONS

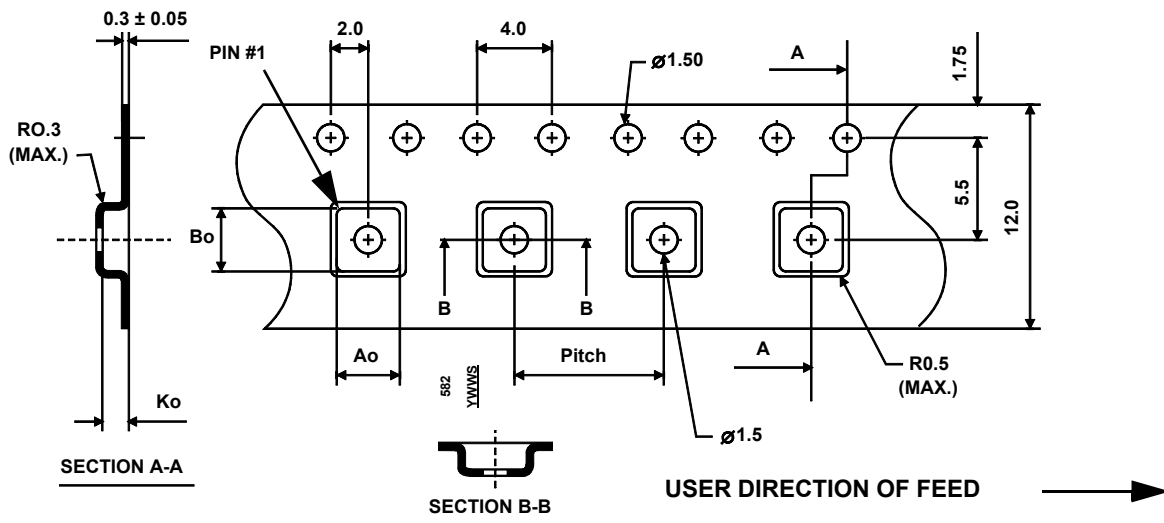

Recommended Reflow Profile

1. Preheating shall be fixed at 150~180°C for 60~90 seconds.
2. Ascending time to preheating temperature 150°C shall be 30 seconds min.
3. Heating shall be fixed at 220°C for 50~80 seconds and at 260°C+0/-5°C peak (10 seconds).
4. Time: 5 times maximum.

