



WTB2S-2P3251

W2S-2

MINIATURE PHOTOELECTRIC SENSORS

SICK
Sensor Intelligence.



Ordering information

Type	Part no.
WTB2S-2P3251	1066111

Other models and accessories → www.sick.com/W2S-2

Illustration may differ



Detailed technical data

Features

Sensor/ detection principle	Photoelectric proximity sensor, Background suppression
Dimensions (W x H x D)	7.7 mm x 27.5 mm x 13.5 mm
Housing design (light emission)	Rectangular
Sensing range max.	1 mm ... 150 mm ¹⁾
Sensing range	18 mm ... 110 mm ¹⁾
Type of light	Visible red light
Light source	PinPoint LED ²⁾
Light spot size (distance)	Ø 3.5 mm (50 mm)
Wave length	640 nm
Adjustment	Potentiometer, 3 turns
Special applications	Detecting small objects

¹⁾ Object with 90 % reflectance (referred to standard white, DIN 5033).

²⁾ Average service life: 100,000 h at T_J = +25 °C.

Mechanics/electronics

Supply voltage	10 V DC ... 30 V DC ¹⁾
Ripple	$\leq 5 V_{pp}$ ²⁾
Power consumption	20 mA ³⁾
Switching output	PNP
Switching mode	Light/dark switching
Output current I_{max}	< 50 mA
Response time	< 0.5 ms ⁴⁾
Switching frequency	1,000 Hz ⁵⁾
Connection type	Cable with M8 male connector, 4-pin, 200 mm ⁶⁾
Cable material	PVC
Cable diameter	Ø 3 mm
Circuit protection	A ⁷⁾ B ⁸⁾ D ⁹⁾
Housing material	Plastic, ABS/PC
Optics material	Plastic, PMMA
Enclosure rating	IP67
Ambient operating temperature	-25 °C ... +50 °C
Ambient storage temperature	-40 °C ... +75 °C
UL File No.	NRKH.E181493

1) Limit values.

2) May not exceed or fall below U_v tolerances.

3) Without load.

4) Signal transit time with resistive load.

5) With light/dark ratio 1:1.

6) Do not bend below 0 °C.

7) A = V_S connections reverse-polarity protected.

8) B = output reverse-polarity protected.

9) D = outputs overcurrent and short-circuit protected.

Safety-related parameters

MTTF_D	3,487 years
DC_{avg}	0%

Classifications

ECl@ss 5.0	27270904
ECl@ss 5.1.4	27270904
ECl@ss 6.0	27270904
ECl@ss 6.2	27270904
ECl@ss 7.0	27270904
ECl@ss 8.0	27270904
ECl@ss 8.1	27270904
ECl@ss 9.0	27270904

ETIM 5.0	EC002719
ETIM 6.0	EC002719
UNSPSC 16.0901	39121528

Connection diagram

Connection diagram

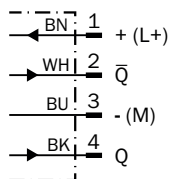

Characteristic curve

WTB2S-2, 150 mm

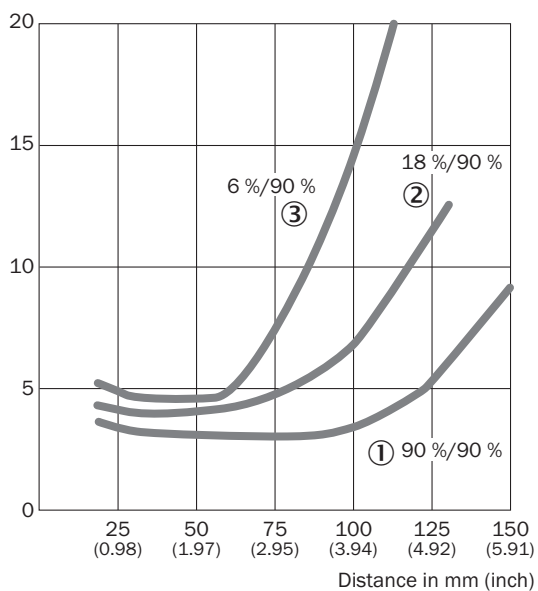

- ① Sensing range on white, 90% remission
- ② Sensing range on gray, 18% remission
- ③ Sensing range on black, 6% remission

Light spot size

WTB2S-2, 150 mm

Spot diameter in mm (inch)

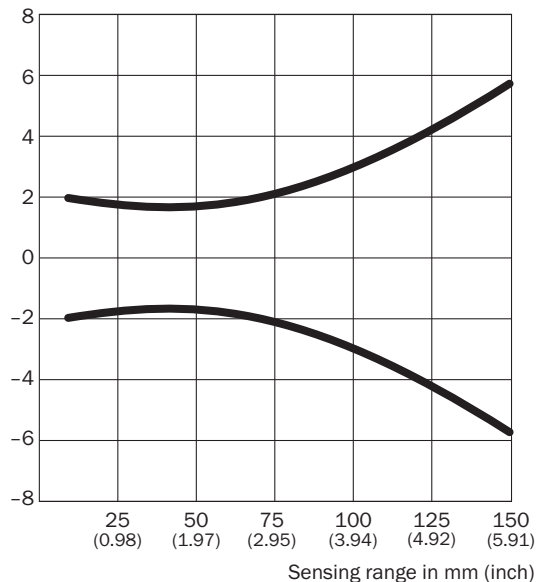

Dimensions in mm (inch)

Sensing range	Spot diameter
10 (0.39)	4.0 (0.16)
20 (0.79)	3.7 (0.15)
40 (1.57)	3.4 (0.13)
80 (3.15)	4.4 (0.17)
120 (4.72)	8.0 (0.31)
150 (5.91)	11.5 (0.45)

Sensing range diagram

WTB2S-2, 150 mm

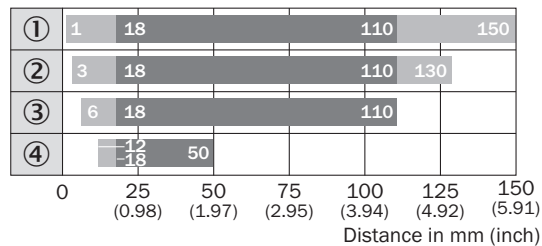

■ Sensing range ■ Sensing range max.

- ① Sensing range on white, 90% remission
- ② Sensing range on gray, 18% remission
- ③ Sensing range on black, 6% remission
- ④ Sensing range on ultra black, 1% remission

Dimensional drawing (Dimensions in mm (inch))

WTB2S-2, 150 mm

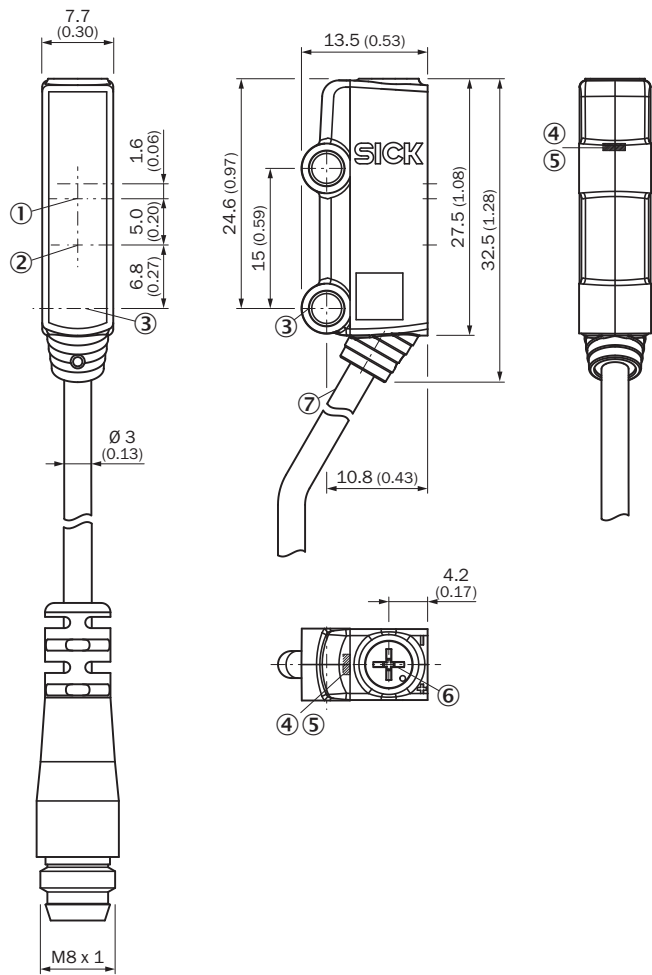





- ① Optical axis, receiver
- ② Optical axis, sender
- ③ Mounting hole, \varnothing 3.2 mm
- ④ LED indicator green: Supply voltage active
- ⑤ LED indicator yellow: Status of received light beam
- ⑥ Potentiometer
- ⑦ Connection

Recommended accessories

Other models and accessories → www.sick.com/W2S-2

	Brief description	Type	Part no.
Mounting brackets and plates			
	Mounting bracket for floor mounting, steel, zinc coated, without mounting hardware	BEF-W2S-A	4034748

	Brief description	Type	Part no.
	Mounting bracket for wall mounting, steel, zinc coated, without mounting hardware	BEF-W2S-B	4034749
Terminal and alignment brackets			
	Ball clamp bracket, plastic, mounting hardware included	BEF-GH-MINI01	2023160
Plug connectors and cables			
	Head A: female connector, M8, 4-pin, straight, A-coded Head B: Flying leads Cable: Sensor/actuator cable, PVC, unshielded, 2 m	YF8U14-020VA3XLEAX	2095888
	Head A: female connector, M8, 4-pin, straight, A-coded Head B: Flying leads Cable: Sensor/actuator cable, PVC, unshielded, 5 m	YF8U14-050VA3XLEAX	2095889
	Head A: female connector, M8, 4-pin, angled, A-coded Head B: Flying leads Cable: Sensor/actuator cable, PVC, unshielded, 2 m	YG8U14-020VA3XLEAX	2095962
	Head A: female connector, M8, 4-pin, angled, A-coded Head B: Flying leads Cable: Sensor/actuator cable, PVC, unshielded, 5 m	YG8U14-050VA3XLEAX	2095963

SICK AT A GLANCE

SICK is one of the leading manufacturers of intelligent sensors and sensor solutions for industrial applications. A unique range of products and services creates the perfect basis for controlling processes securely and efficiently, protecting individuals from accidents and preventing damage to the environment.

We have extensive experience in a wide range of industries and understand their processes and requirements. With intelligent sensors, we can deliver exactly what our customers need. In application centers in Europe, Asia and North America, system solutions are tested and optimized in accordance with customer specifications. All this makes us a reliable supplier and development partner.

Comprehensive services complete our offering: SICK LifeTime Services provide support throughout the machine life cycle and ensure safety and productivity.

For us, that is “Sensor Intelligence.”

WORLDWIDE PRESENCE:

Contacts and other locations –www.sick.com