

# MSD42T1G

## NPN Silicon General Purpose High Voltage Transistors

This NPN Silicon Planar Transistor is designed for general purpose amplifier applications. This device is housed in the SC-59 package which is designed for low power surface mount applications.

### Features

- These Devices are Pb-Free, Halogen Free/BFR Free and are RoHS Compliant

### MAXIMUM RATINGS ( $T_A = 25^\circ\text{C}$ )

Rating	Symbol	Value	Unit
Collector-Base Voltage	$V_{(BR)CBO}$	300	Vdc
Collector-Emitter Voltage	$V_{(BR)CEO}$	300	Vdc
Emitter-Base Voltage	$V_{(BR)EBO}$	6.0	Vdc
Collector Current – Continuous	$I_C$	150	mAdc

### THERMAL CHARACTERISTICS

Rating	Symbol	Max	Unit
Power Dissipation (Note 1)	$P_D$	450	mW
Thermal Resistance, Junction-to-Ambient	$R_{\theta JA}$	274	$^\circ\text{C/W}$
Junction and Storage Temperature Range	$T_J, T_{stg}$	-55 to +150	$^\circ\text{C}$

Stresses exceeding Maximum Ratings may damage the device. Maximum Ratings are stress ratings only. Functional operation above the Recommended Operating Conditions is not implied. Extended exposure to stresses above the Recommended Operating Conditions may affect device reliability.

### ELECTRICAL CHARACTERISTICS

Characteristic	Symbol	Min	Max	Unit
Collector-Emitter Breakdown Voltage ( $I_C = 1.0 \text{ mAdc}, I_B = 0$ )	$V_{(BR)CEO}$	300	-	Vdc
Collector-Base Breakdown Voltage ( $I_C = 100 \mu\text{Adc}, I_E = 0$ )	$V_{(BR)CBO}$	300	-	Vdc
Emitter-Base Breakdown Voltage ( $I_E = 100 \mu\text{Adc}, I_C = 0$ )	$V_{(BR)EBO}$	6.0	-	Vdc
Collector-Base Cutoff Current ( $V_{CB} = 200 \text{ Vdc}, I_E = 0$ )	$I_{CBO}$	-	0.1	$\mu\text{A}$
Emitter-Base Cutoff Current ( $V_{EB} = 6.0 \text{ Vdc}, I_B = 0$ )	$I_{EBO}$	-	0.1	$\mu\text{A}$
DC Current Gain (Note 2) ( $V_{CE} = 10 \text{ Vdc}, I_C = 1.0 \text{ mAdc}$ ) ( $V_{CE} = 10 \text{ Vdc}, I_C = 30 \text{ mAdc}$ )	$h_{FE1}$ $h_{FE2}$	25 40	- -	-
Collector-Emitter Saturation Voltage (Note 2) ( $I_C = 20 \text{ mAdc}, I_B = 2.0 \text{ mAdc}$ )	$V_{CE(sat)}$	-	0.5	Vdc

1. FR-4 @ 10 mm<sup>2</sup>, 1 oz. Copper traces.
2. Pulse Test: Pulse Width  $\leq 300 \mu\text{s}$ , D.C.  $\leq 2\%$ .



ON Semiconductor®

<http://onsemi.com>

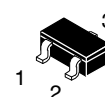
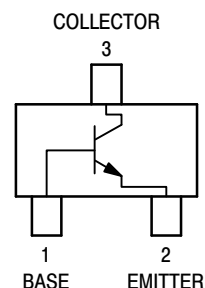

SC-59  
CASE 318D  
STYLE 1

### MARKING DIAGRAM

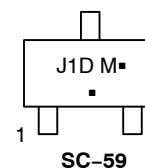

J1D = Specific Device Code  
M = Date Code  
▪ = Pb-Free Package  
(Note: Microdot may be in either location)

### ORDERING INFORMATION

Device	Package	Shipping†
MSD42T1G	SC-59 (Pb-Free)	3000 / Tape & Reel

†For information on tape and reel specifications, including part orientation and tape sizes, please refer to our Tape and Reel Packaging Specifications Brochure, BRD8011/D.

# MSD42T1G

## TYPICAL CHARACTERISTICS

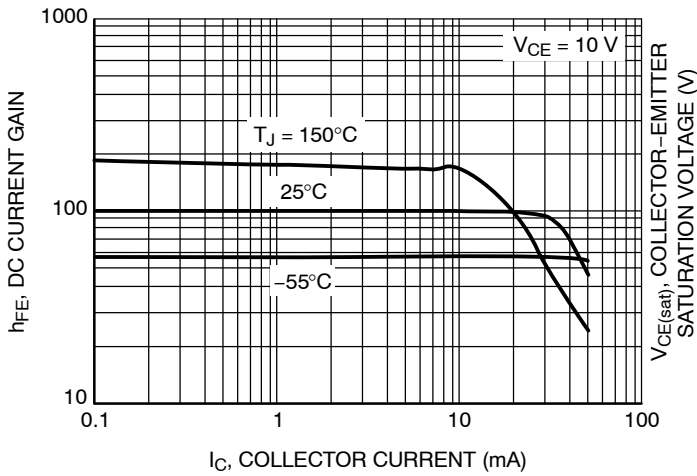

Figure 1. DC Current Gain

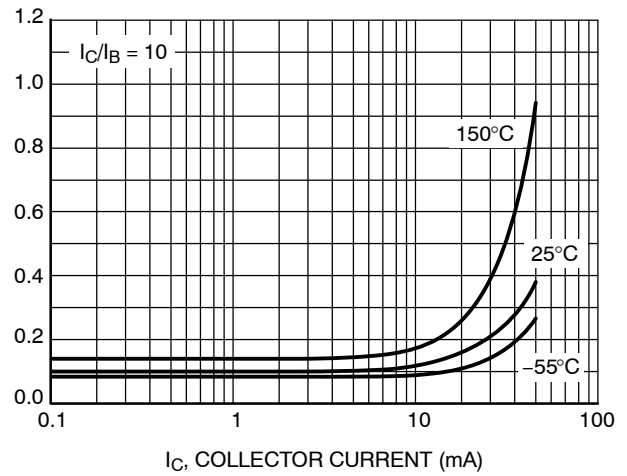

Figure 2. Collector-Emitter Saturation Voltage vs. Collector Current

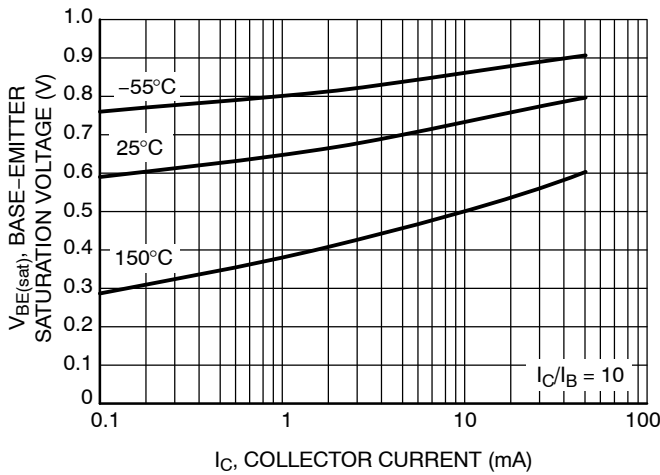

Figure 3. Base-Emitter Saturation Voltage vs. Collector Current

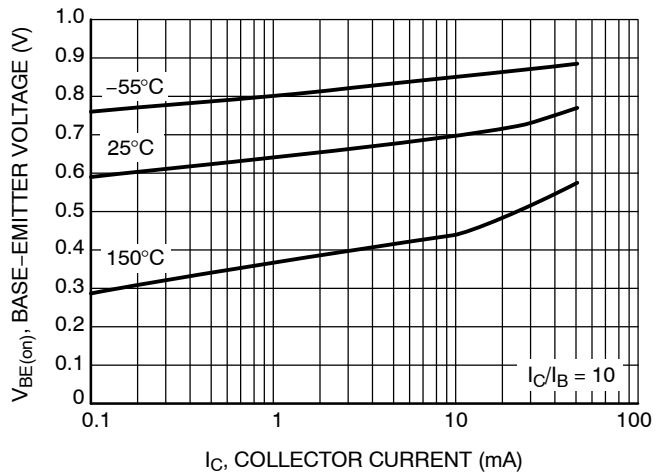

Figure 4. Base-Emitter On Voltage vs. Collector Current

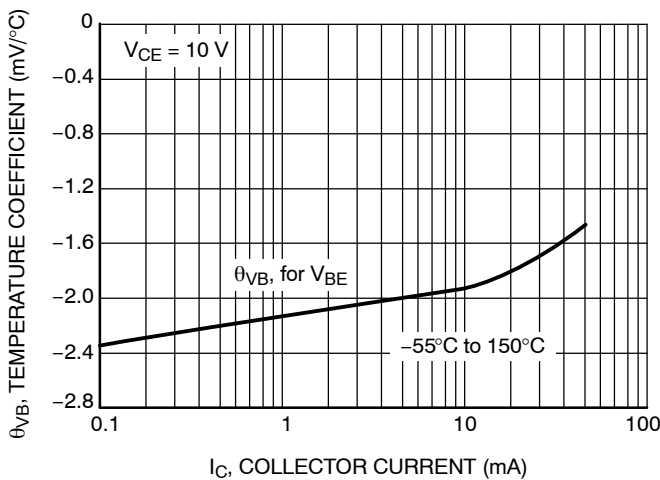

Figure 5. Base-Emitter Temperature Coefficient

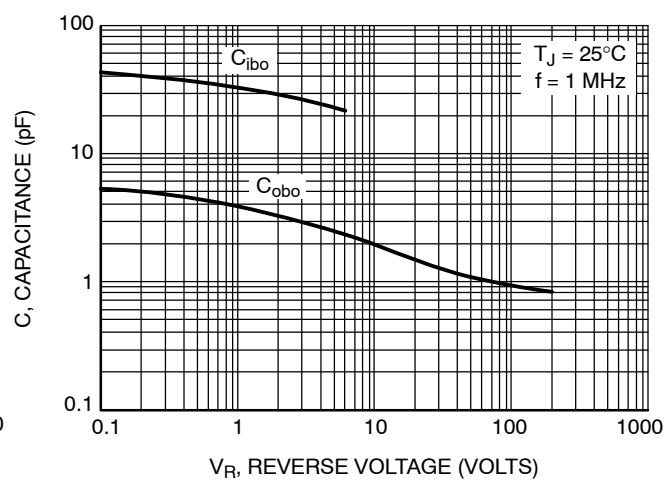

Figure 6. Capacitance

# MSD42T1G

## TYPICAL CHARACTERISTICS

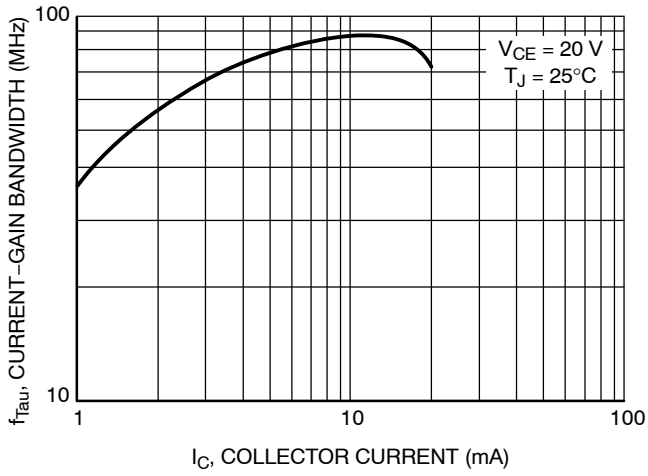

Figure 7. Current-Gain — Bandwidth Product

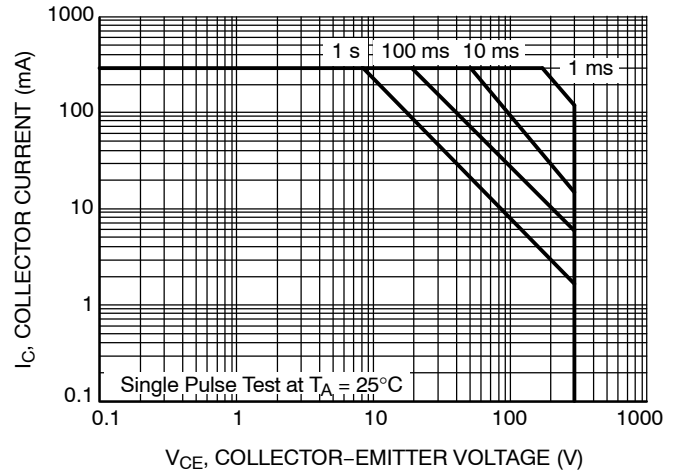

Figure 8. Safe Operating Area

# MECHANICAL CASE OUTLINE

## PACKAGE DIMENSIONS

ON Semiconductor®



SC-59  
CASE 318D-04  
ISSUE H

DATE 28 JUN 2012

SCALE 2:1

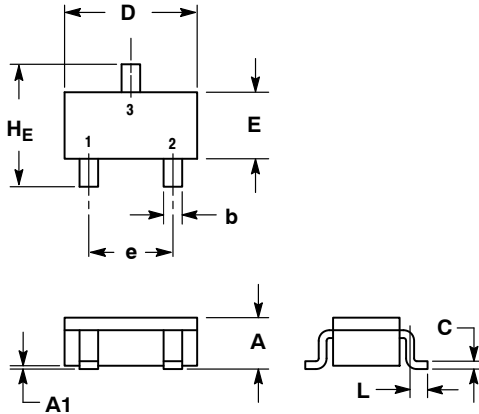

### SOLDERING FOOTPRINT\*

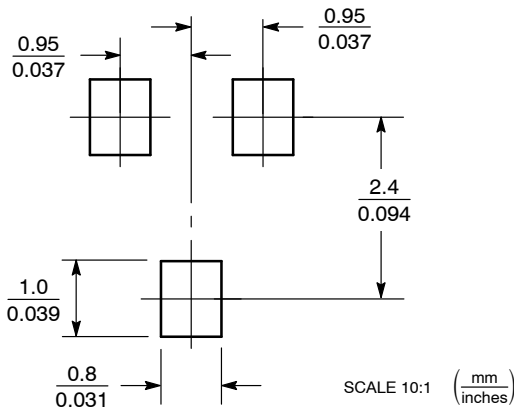

\*For additional information on our Pb-Free strategy and soldering details, please download the ON Semiconductor Soldering and Mounting Techniques Reference Manual, SOLDERRM/D.

NOTES:  
1. DIMENSIONING AND TOLERANCING PER ANSI Y14.5M, 1982.  
2. CONTROLLING DIMENSION: MILLIMETER.

DIM	MILLIMETERS			INCHES		
	MIN	NOM	MAX	MIN	NOM	MAX
A	1.00	1.15	1.30	0.039	0.045	0.051
A1	0.01	0.06	0.10	0.001	0.002	0.004
b	0.35	0.43	0.50	0.014	0.017	0.020
c	0.09	0.14	0.18	0.003	0.005	0.007
D	2.70	2.90	3.10	0.106	0.114	0.122
E	1.30	1.50	1.70	0.051	0.059	0.067
e	1.70	1.90	2.10	0.067	0.075	0.083
L	0.20	0.40	0.60	0.008	0.016	0.024
HE	2.50	2.80	3.00	0.099	0.110	0.118

### GENERIC MARKING DIAGRAM

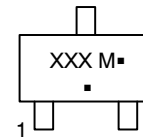

XXX = Specific Device Code  
M = Date Code  
▪ = Pb-Free Package\*

(\*Note: Microdot may be in either location)

\*This information is generic. Please refer to device data sheet for actual part marking. Pb-Free indicator, "G" or microdot "▪", may or may not be present.

STYLE 1:  
PIN 1. BASE  
2. EMITTER  
3. COLLECTOR

STYLE 2:  
PIN 1. ANODE  
2. N.C.  
3. CATHODE

STYLE 3:  
PIN 1. ANODE  
2. ANODE  
3. CATHODE

STYLE 4:  
PIN 1. CATHODE  
2. N.C.  
3. ANODE

STYLE 5:  
PIN 1. CATHODE  
2. CATHODE  
3. ANODE

STYLE 6:  
PIN 1. ANODE  
2. CATHODE  
3. ANODE/CATHODE

DOCUMENT NUMBER:	98ASB42664B	Electronic versions are uncontrolled except when accessed directly from the Document Repository. Printed versions are uncontrolled except when stamped "CONTROLLED COPY" in red.
DESCRIPTION:	SC-59	PAGE 1 OF 1

ON Semiconductor and ON are trademarks of Semiconductor Components Industries, LLC dba ON Semiconductor or its subsidiaries in the United States and/or other countries. ON Semiconductor reserves the right to make changes without further notice to any products herein. ON Semiconductor makes no warranty, representation or guarantee regarding the suitability of its products for any particular purpose, nor does ON Semiconductor assume any liability arising out of the application or use of any product or circuit, and specifically disclaims any and all liability, including without limitation special, consequential or incidental damages. ON Semiconductor does not convey any license under its patent rights nor the rights of others.

**onsemi**, **Onsemi**, and other names, marks, and brands are registered and/or common law trademarks of Semiconductor Components Industries, LLC dba "**onsemi**" or its affiliates and/or subsidiaries in the United States and/or other countries. **onsemi** owns the rights to a number of patents, trademarks, copyrights, trade secrets, and other intellectual property. A listing of **onsemi**'s product/patent coverage may be accessed at [www.onsemi.com/site/pdf/Patent-Marking.pdf](http://www.onsemi.com/site/pdf/Patent-Marking.pdf). **onsemi** reserves the right to make changes at any time to any products or information herein, without notice. The information herein is provided "as-is" and **onsemi** makes no warranty, representation or guarantee regarding the accuracy of the information, product features, availability, functionality, or suitability of its products for any particular purpose, nor does **onsemi** assume any liability arising out of the application or use of any product or circuit, and specifically disclaims any and all liability, including without limitation special, consequential or incidental damages. Buyer is responsible for its products and applications using **onsemi** products, including compliance with all laws, regulations and safety requirements or standards, regardless of any support or applications information provided by **onsemi**. "Typical" parameters which may be provided in **onsemi** data sheets and/or specifications can and do vary in different applications and actual performance may vary over time. All operating parameters, including "Typicals" must be validated for each customer application by customer's technical experts. **onsemi** does not convey any license under any of its intellectual property rights nor the rights of others. **onsemi** products are not designed, intended, or authorized for use as a critical component in life support systems or any FDA Class 3 medical devices or medical devices with a same or similar classification in a foreign jurisdiction or any devices intended for implantation in the human body. Should Buyer purchase or use **onsemi** products for any such unintended or unauthorized application, Buyer shall indemnify and hold **onsemi** and its officers, employees, subsidiaries, affiliates, and distributors harmless against all claims, costs, damages, and expenses, and reasonable attorney fees arising out of, directly or indirectly, any claim of personal injury or death associated with such unintended or unauthorized use, even if such claim alleges that **onsemi** was negligent regarding the design or manufacture of the part. **onsemi** is an Equal Opportunity/Affirmative Action Employer. This literature is subject to all applicable copyright laws and is not for resale in any manner.

## ADDITIONAL INFORMATION

### TECHNICAL PUBLICATIONS:

Technical Library: [www.onsemi.com/design/resources/technical-documentation](http://www.onsemi.com/design/resources/technical-documentation)  
onsemi Website: [www.onsemi.com](http://www.onsemi.com)

### ONLINE SUPPORT: [www.onsemi.com/support](http://www.onsemi.com/support)

For additional information, please contact your local Sales Representative at [www.onsemi.com/support/sales](http://www.onsemi.com/support/sales)