

RSAN SERIES

Multipurpose Single-Phase Filter Compatible with High-Voltage Pulse

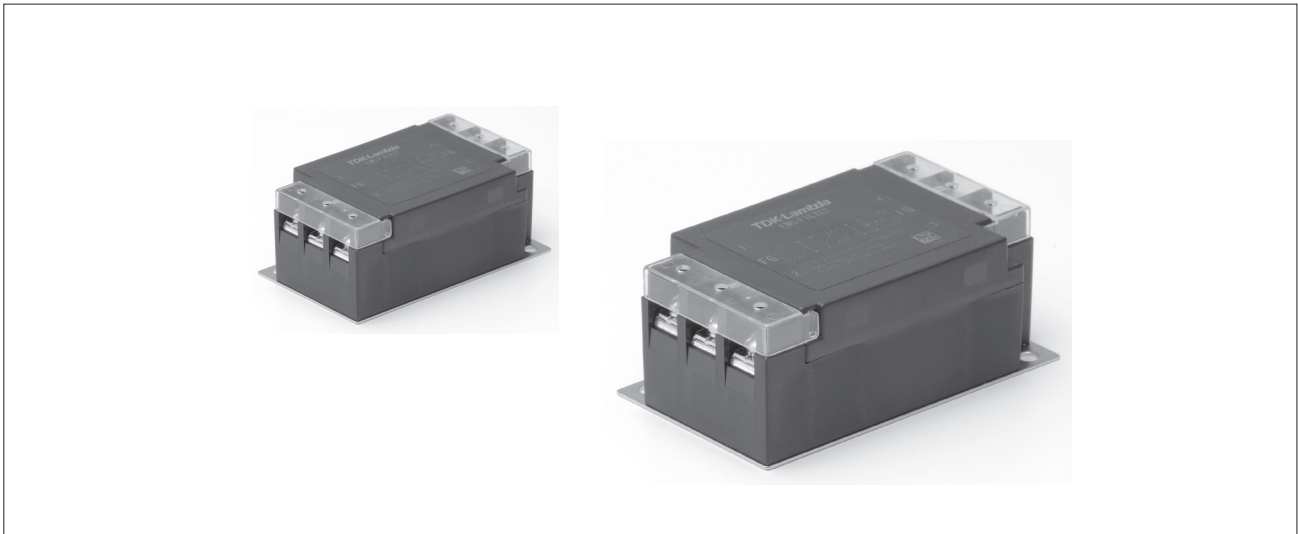

FEATURES

- Amorphous core is used as the common mode coil core for the RSEN series, which helps prevent device error.
- Self-tightening screws and an open/close type cover make wiring work easier.
- Optional low-leakage current characteristic type and DIN rail installation compatible type are also available.

SAFETY STANDARDS

UL1283	UL File No. E62388
CSA C22.2 No.8	CSA File No. LR76849
EN60939-1/-2 (ENEC14)	Licence Ref. No. SE/07115-2

PRODUCT IDENTIFICATION

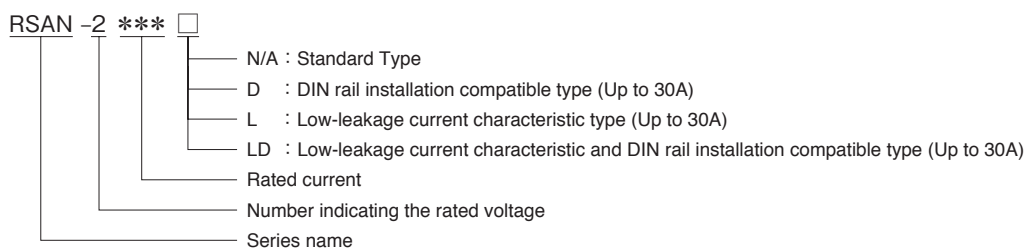

CONFORMITY TO RoHS Directive

CIRCUIT DIAGRAMS

RSAN-2 ***
RSAN-2 *** D

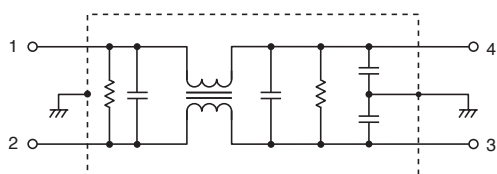

RSAN-2 *** L

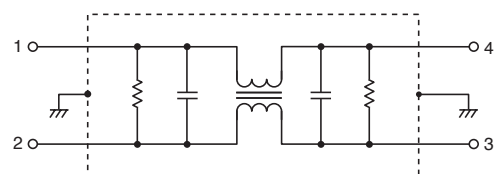

ELECTRICAL CHARACTERISTICS

Part No.	Rated voltage (AC/DC)	Rated current (AC/DC)	Withstand voltage	Insulation resistance	Leakage current	Operating temperature range	With derating over	DC resistance (mΩ)	Attenuation frequency range (MHz)			Weight (g)
									Common mode		Differential mode	
									at 25dB	at 20dB	at 25dB	
RSAN-2003	250V	3A	AC.2500V 60s [Between line to ground]	100MΩ min. [DC.500V/ 1min]	1.0mA max. [250V/60Hz]	-25 to +85°C	55°C	250 max.	0.1 to 10	-	0.1 to 30	170
RSAN-2006		6A						110 max.	0.1 to 10	-	0.1 to 30	230
RSAN-2010		10A						40 max.	0.3 to 10	-	0.2 to 30	230
RSAN-2016		16A						20 max.	0.8 to 10	-	0.3 to 30	230
RSAN-2020		20A						10 max.	1 to 10	-	0.3 to 30	230
RSAN-2030		30A						6 max.	2 to 10	-	0.4 to 30	230
RSAN-2040		40A						6 max.	0.8 to 10	-	0.1 to 30	870
RSAN-2050		50A						4 max.	-	1 to 10	0.1 to 30	870
RSAN-2060		60A						3 max.	2 to 10	-	0.2 to 30	870

Part No.	Rated voltage (AC/DC)	Rated current (AC/DC)	Withstand voltage	Insulation resistance	Leakage current	Operating temperature range	With derating over	DC resistance (mΩ)	Attenuation frequency range (MHz)			Weight (g)
									Common mode		Differential mode	
									at 20dB	at 10dB	at 25dB	
RSAN-2003L	250V	3A	AC.2500V 60s [Between line to ground]	100MΩ min. [DC.500V/ 1min]	10 μA max. [250V/60Hz]	-25 to +85°C	55°C	250 max.	0.1 to 3	-	0.1 to 30	170
RSAN-2006L		6A						110 max.	0.1 to 3	-	0.1 to 30	230
RSAN-2010L		10A						40 max.	0.5 to 6	-	0.2 to 30	230
RSAN-2016L		16A						20 max.	-	0.3 to 10	0.3 to 30	230
RSAN-2020L		20A						10 max.	-	0.5 to 8	0.3 to 30	230
RSAN-2030L		30A						6 max.	-	3 to 20	0.4 to 30	230

DERATING GRAPH

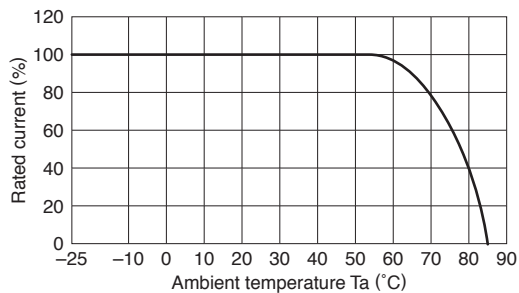

MECHANICAL

RSAN-2003/2006/2010/2016/2020/2030

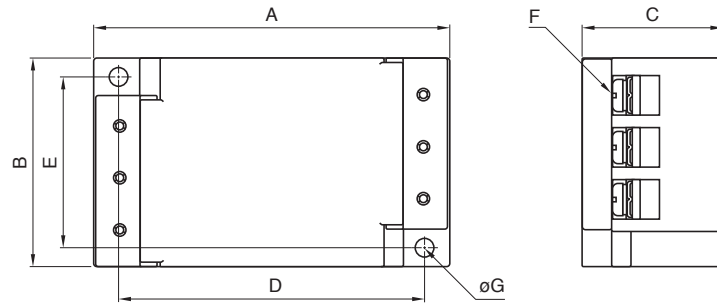

RSAN-2040/2050/2060

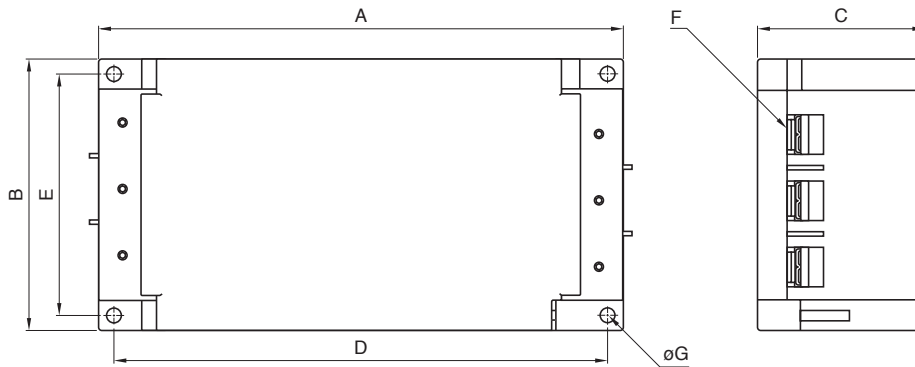

Dimensions in mm

Part No.	A	B	C	D	E	F	ϕG	Recommended clamping torque
RSAN-2003	87	52	35	75	43	M4	4.5	1.27N · m
RSAN-2006								
RSAN-2010								
RSAN-2016								
RSAN-2020								
RSAN-2030	170	90	54	160	80	M5	4.5	2.5N · m
RSAN-2040								
RSAN-2050								
RSAN-2060								

RSAN-2003D/2006D/2010D/2016D/2020D/2030D

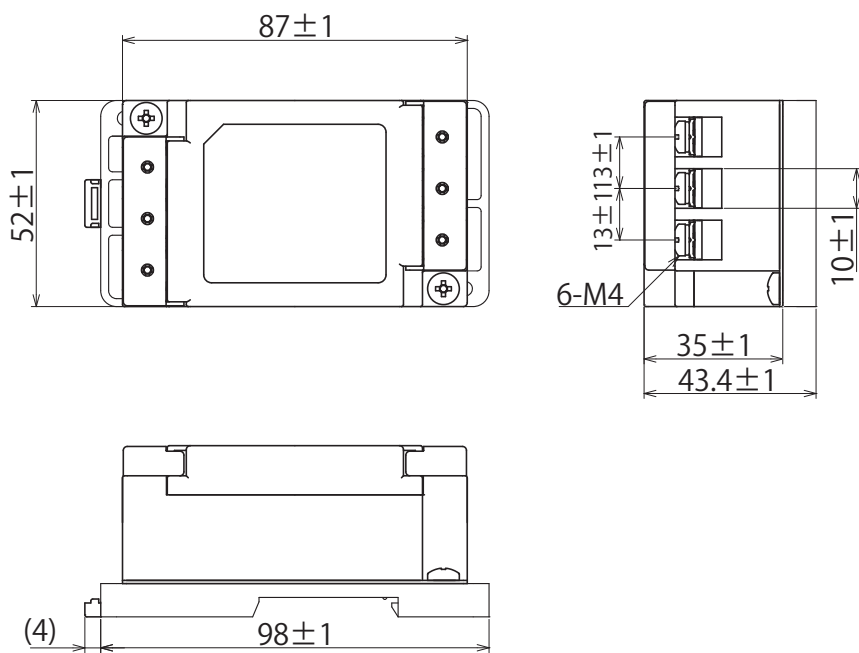

Dimensions in mm

*Please see the next page: "Precautions of DIN rail mounting".

Precautions of DIN rail mounting

When installing on a DIN rail, secure a space with a depth of 14 mm or more from the top of the rail. If there is no depth space, the tip of the DIN attachment and the installation surface may interfere and it may not be possible to install it.

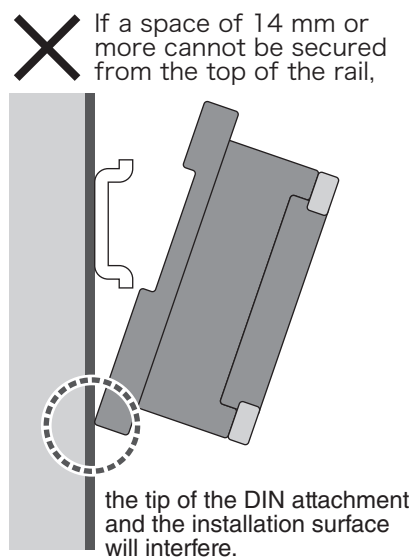
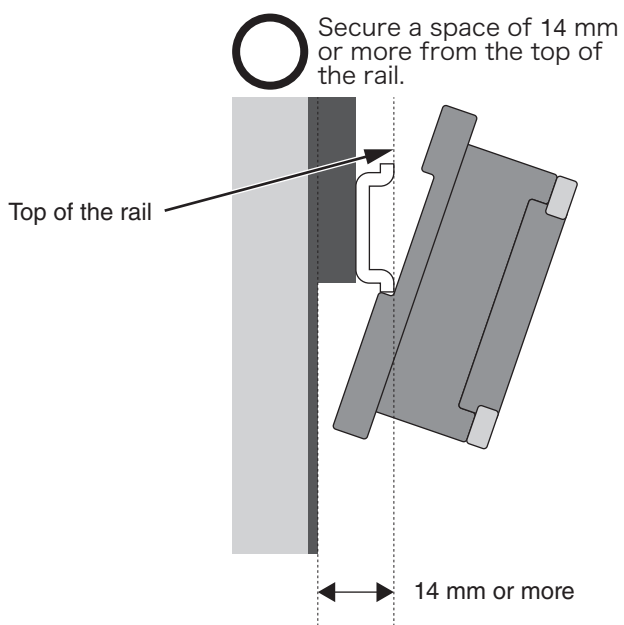

ATTENUATION vs. FREQUENCY CHARACTERISTICS

RSAN-2003

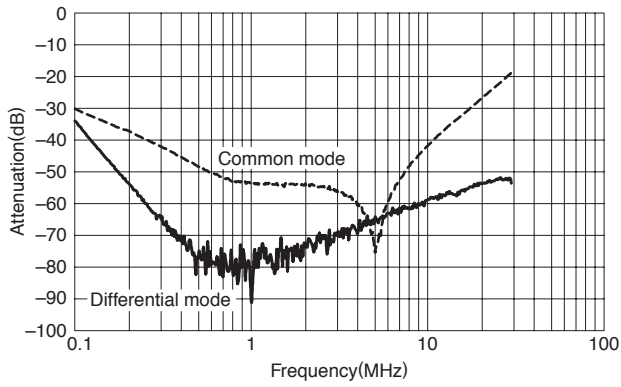

RSAN-2006

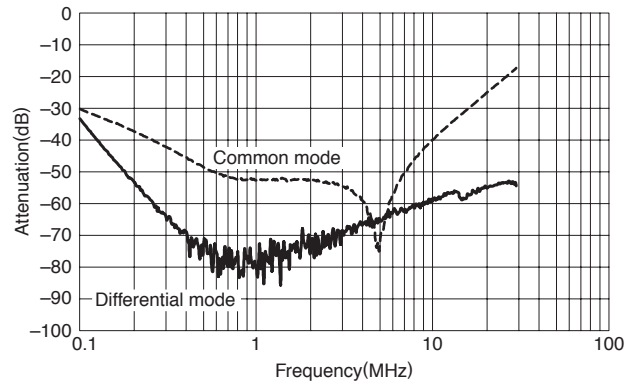

RSAN-2010

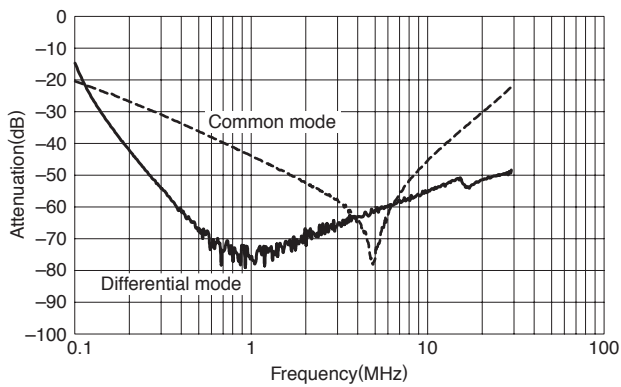

RSAN-2016

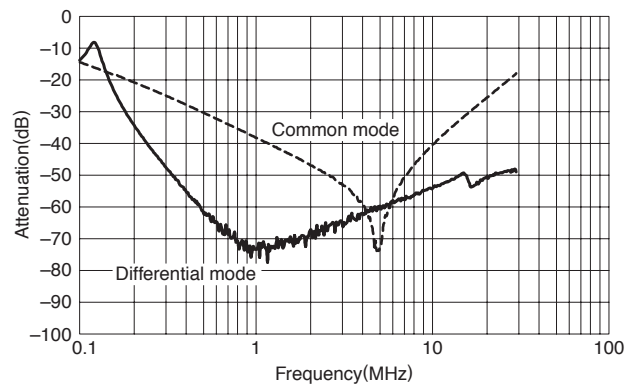

RSAN-2020

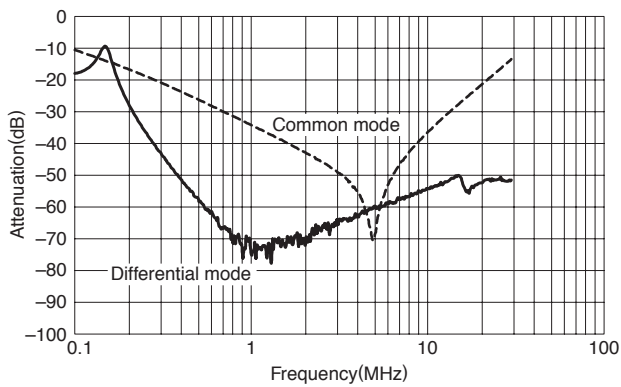

RSAN-2030

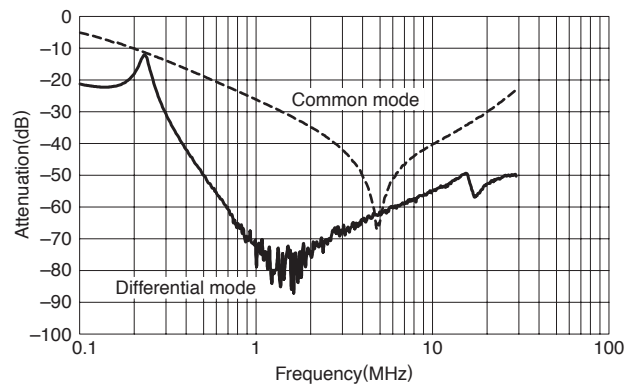

RSAN-2040

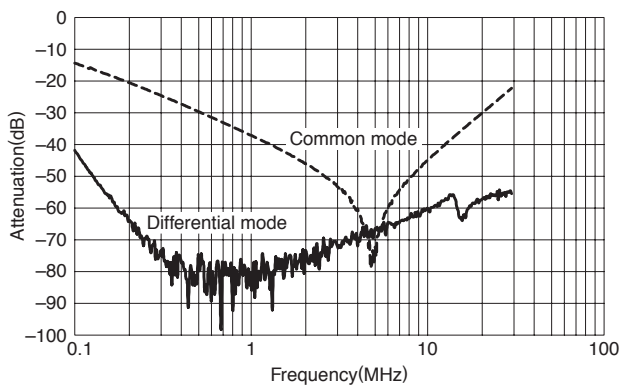

RSAN-2050

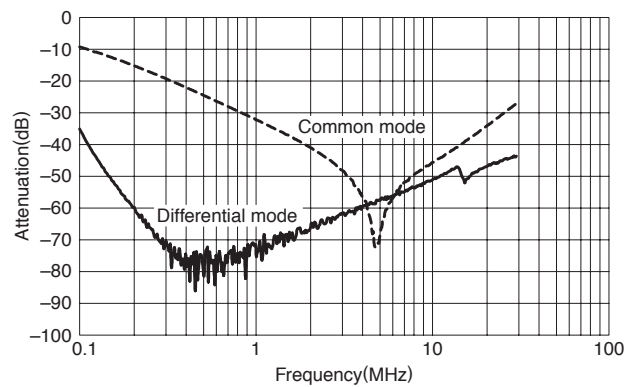

RSAN-2060

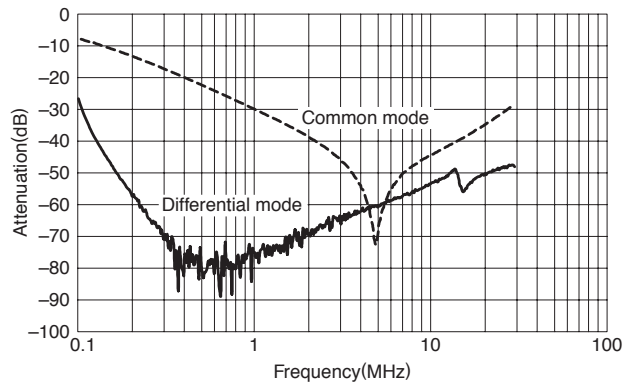

RSAN-2003L

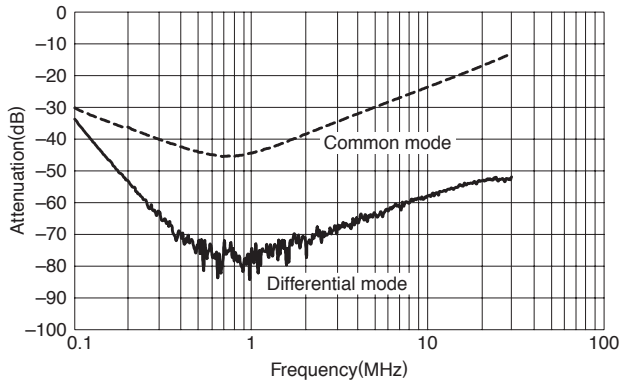

RSAN-2006L

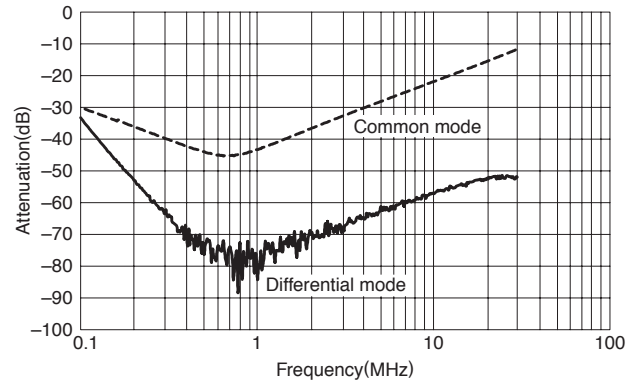

RSAN-2010L

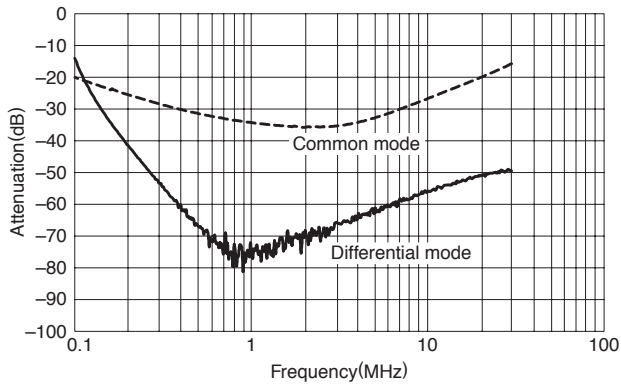

RSAN-2016L

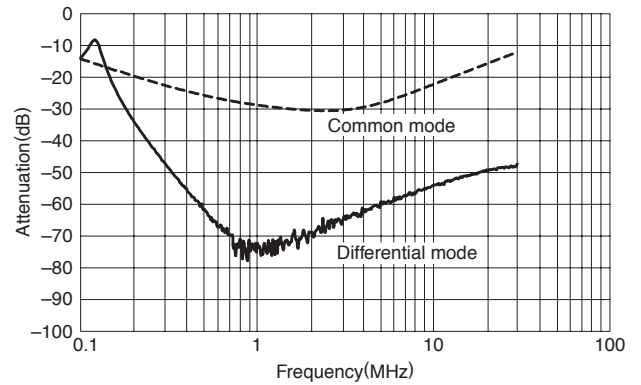

RSAN-2020L

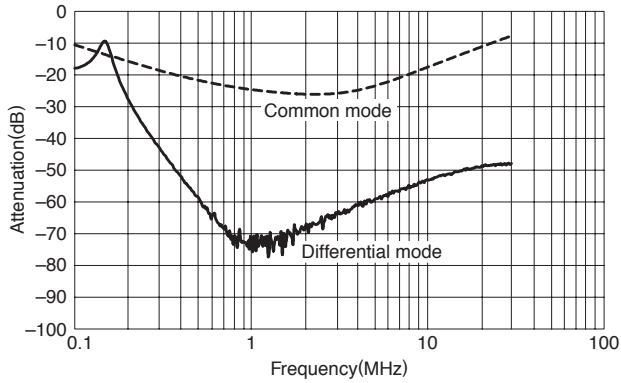

RSAN-2030L

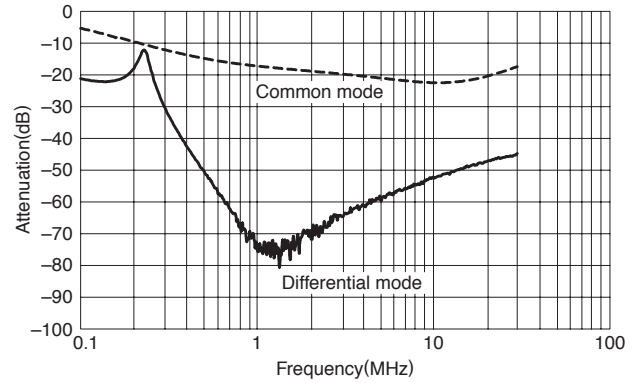

PULSE ATTENUATION CHARACTERISTICS

RSAN-2003/2003D

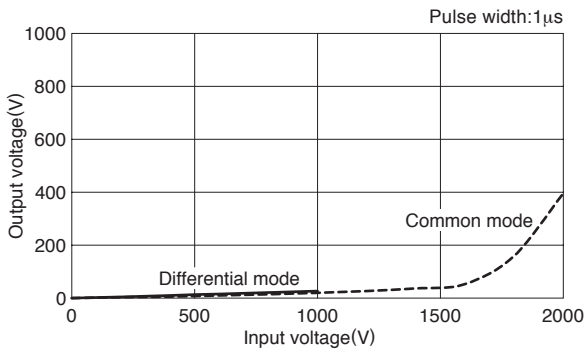

RSAN-2006/2006D

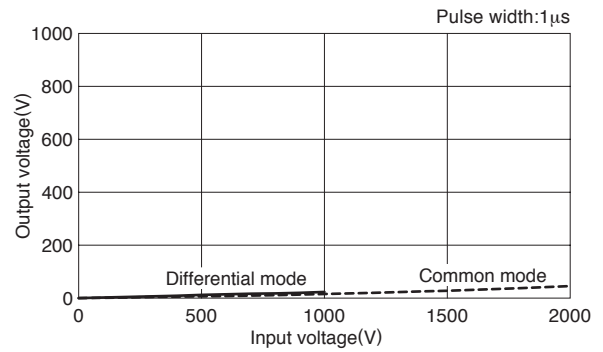

RSAN-2010/2010D

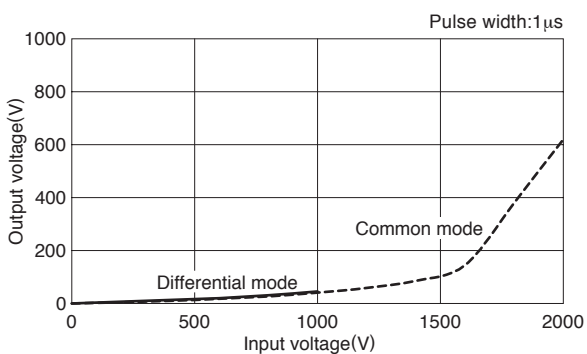

RSAN-2016/2016D

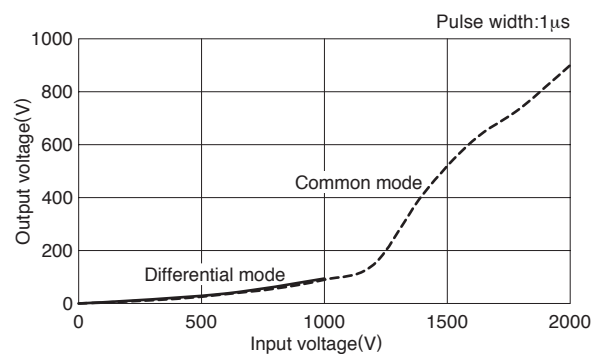

RSAN-2020/2020D

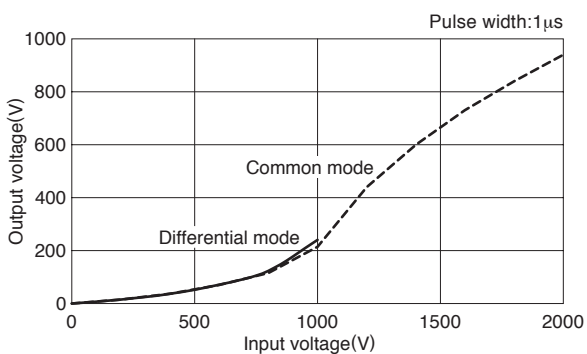

RSAN-2030/2030D

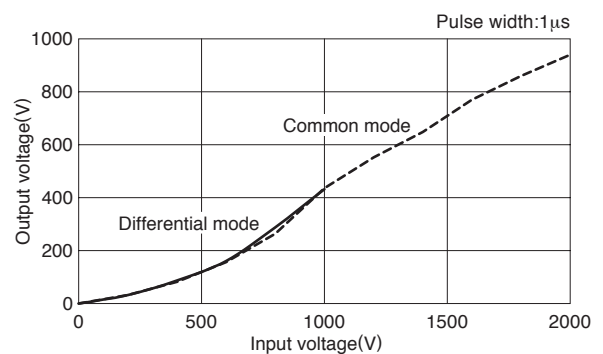

RSAN-2040

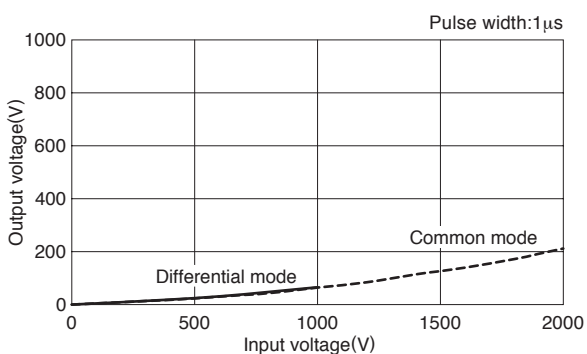

RSAN-2050

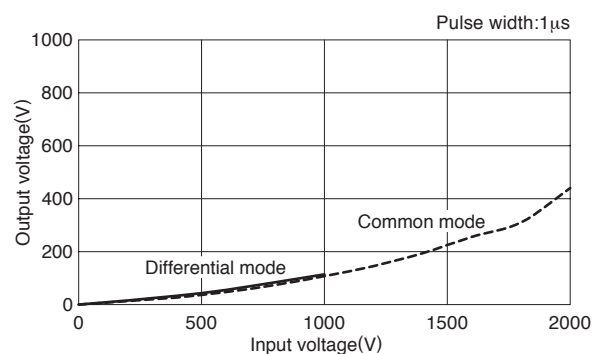

RSAN-2060

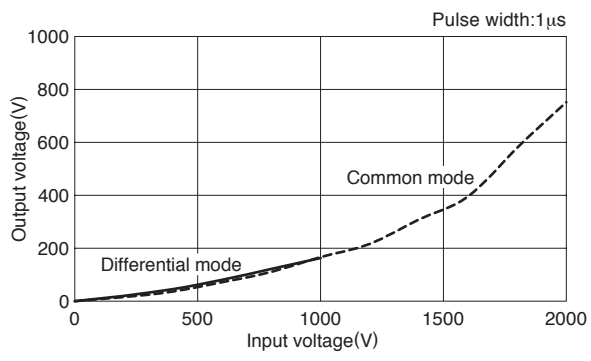

RSAN-2003L/LD

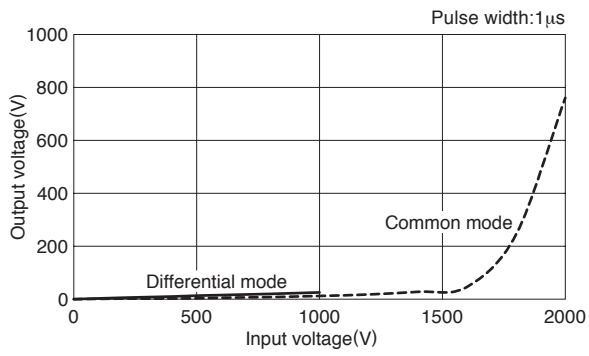

RSAN-2006L/LD

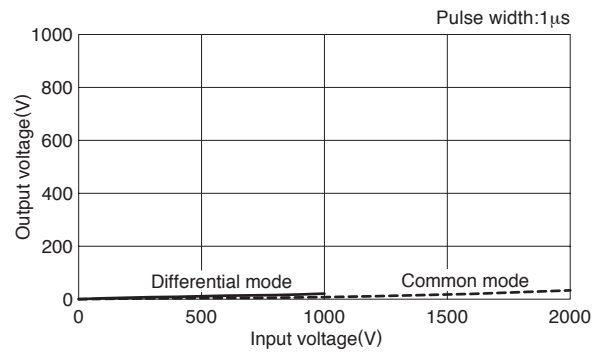

RSAN-2010L/LD

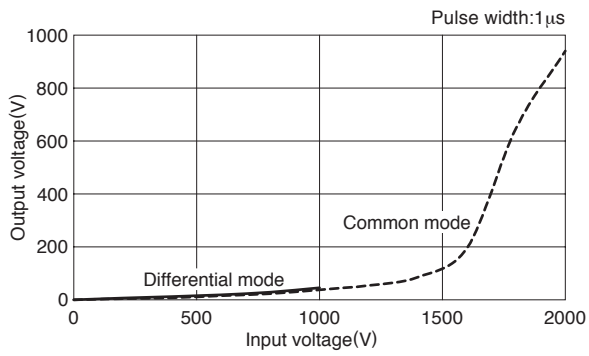

RSAN-2016L/LD

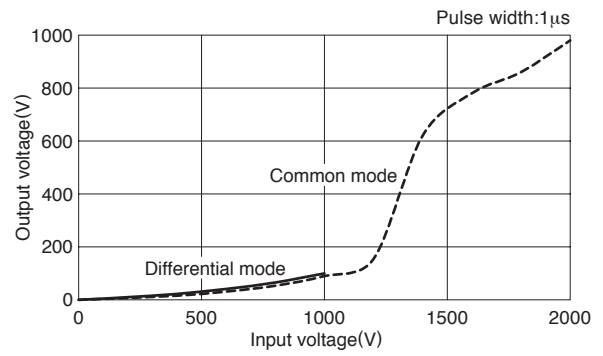

RSAN-2020L/LD

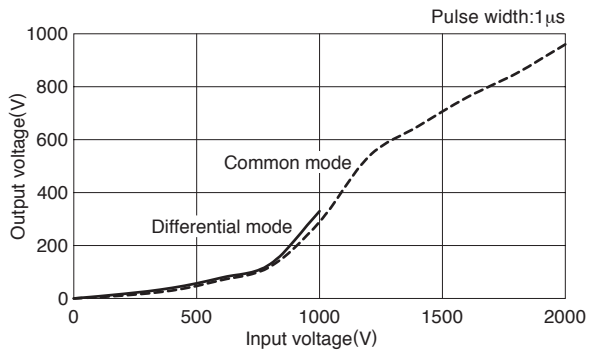

RSAN-2030L/LD

