

SERIES: SWH24-E | **DESCRIPTION:** AC-DC POWER SUPPLY

FEATURES

- household appliance applications
- UL 61558 certified
- IEC 61558 & EN 60335 compliant
- standard in black or white
- universal input voltage range
- European Union fixed blade
- custom designs available
- over current and short circuit protections

MODEL

MODEL	input voltage	input frequency	output voltage	output current	output power	ripple and noise ¹	efficiency level		no load power consumption
	range (Vac)	range (Hz)	nom (Vdc)	max (A)	max (W)	max (mVp-p)	average ² (%)	10% (%)	max (W)
SWH24-8-E	90 ~ 264	47 ~ 63	8	2.5	20.0	240	85.47	70.0	0.1
SWH24-9-E	90 ~ 264	47 ~ 63	9	2.2	19.8	240	85.4	65.0	0.1
SWH24-11-E	90 ~ 264	47 ~ 63	11	2.2	24.2	240	86.24	70.0	0.1
SWH24-12-E	90 ~ 264	47 ~ 63	12	2.0	24.0	240	86.2	65.0	0.1
SWH24-15-E	90 ~ 264	47 ~ 63	15	1.5	22.5	240	85.96	70.0	0.1
SWH24-18-E	90 ~ 264	47 ~ 63	18	1.25	22.5	240	85.96	70.0	0.1
SWH24-19-E	90 ~ 264	47 ~ 63	19	1.25	27.75	240	86.17	70.0	0.1
SWH24-24-E	90 ~ 264	47 ~ 63	24	1.0	24.0	240	86.2	65.0	0.1
SWH24-28-E	90 ~ 264	47 ~ 63	28	0.85	23.8	240	86.17	70.0	0.1
SWH24-36-E	90 ~ 264	47 ~ 63	36	0.65	23.4	240	86.11	70.0	0.1
SWH24-40-E	90 ~ 264	47 ~ 63	40	0.6	24.0	240	86.2	70.0	0.1

Notes: 1. At full load, nominal AC input voltage, 25°C, 20 MHz bandwidth oscilloscope, output terminated with 0.1 µF and 10 µF capacitors to ground.
 2. Average efficiency is measured at 25%, 50%, 75%, and 100% load at 115 Vac & 230 Vac input.

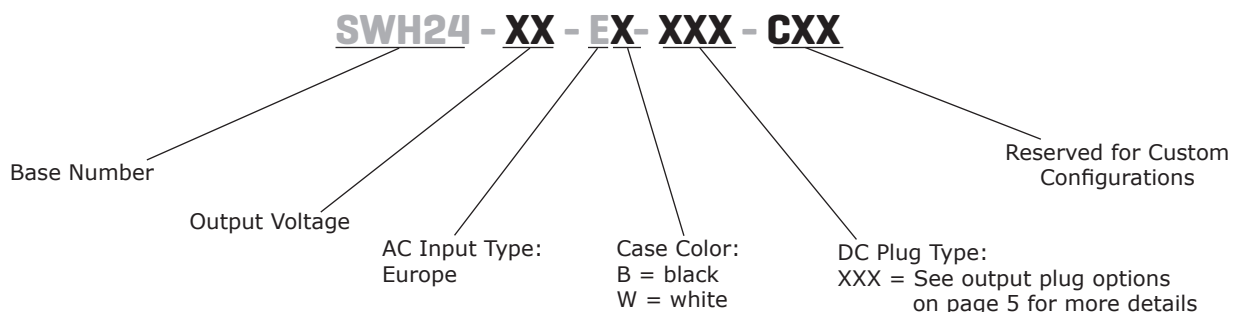
PART NUMBER KEY

INPUT

parameter	conditions/description	min	typ	max	units
voltage		90		264	Vac
frequency		47		63	Hz
current	at full load			0.8	A
leakage current	at 240 Vac, 50 Hz			0.25	mA
no load power consumption				0.1	W

OUTPUT

parameter	conditions/description	min	typ	max	units
line regulation			±1		%
load regulation			±5		%
start-up time	at 100 and 240 Vac, full load			3	s
hold-up time	at 115 Vac/60 Hz at 230 Vac/50 Hz	1 3			ms ms

PROTECTIONS

parameter	conditions/description	min	typ	max	units
over current protection	auto recovery, hiccup				
short circuit protection	auto recovery				

SAFETY & COMPLIANCE

parameter	conditions/description	min	typ	max	units
isolation voltage	input to output at 10 mA for 1 minute		3,000		Vac
safety approvals	EN 60335, EN 61558, EN 60335-2-29, CE				
EMI/EMC	EN 55014-1, EN 55014-2				
MTBF	at full load, 25°C	50,000			hours
RoHS	yes				

ENVIRONMENTAL

parameter	conditions/description	min	typ	max	units
operating temperature		0		40	°C
storage temperature		-20		70	°C
operating humidity		10		95	%
storage humidity		5		95	%

MECHANICAL

parameter	conditions/description	min	typ	max	units
dimensions	69.48 x 44.38 x 48.3				mm
inlet plug	Europe, 2 pin				
weight			80		g

MECHANICAL DRAWING

units: mm

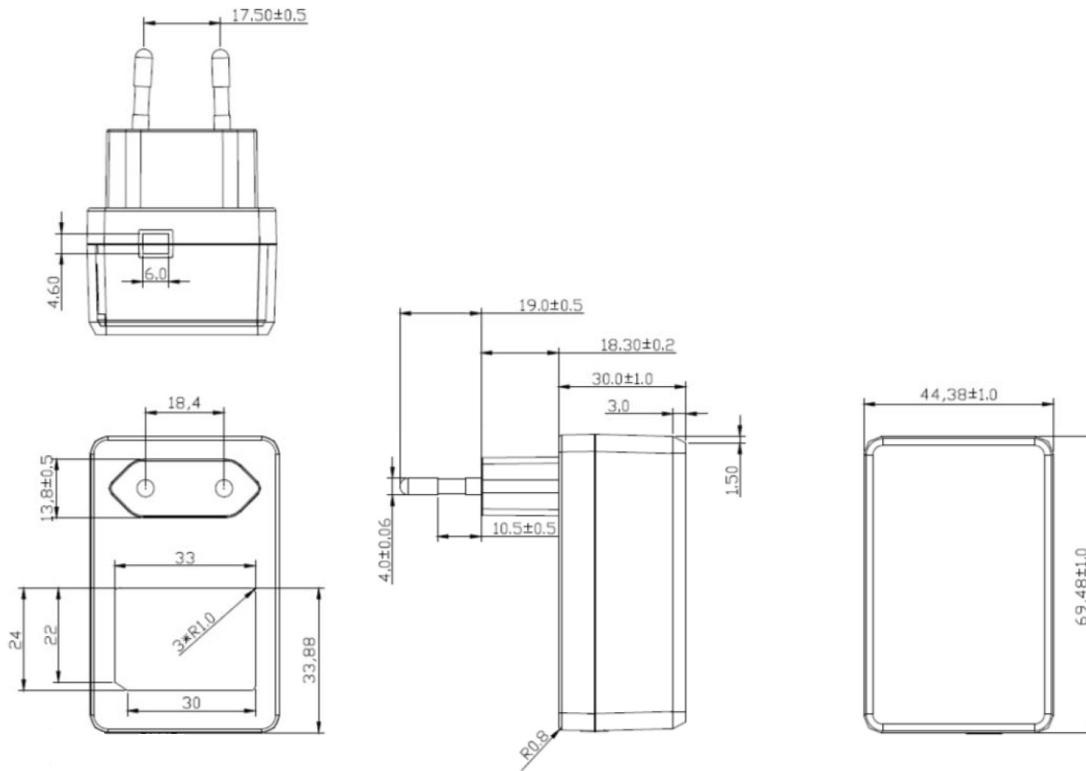

DC CORD

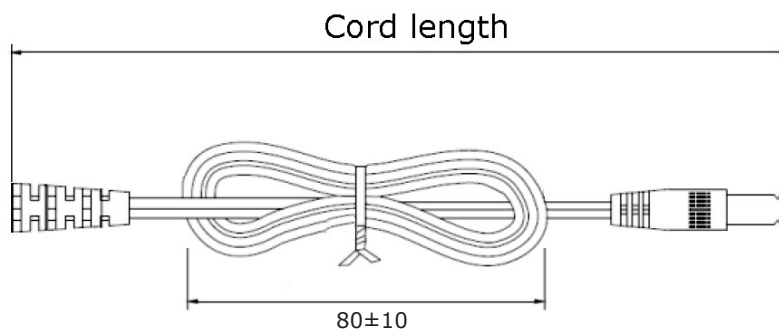

units: mm

**Table 1**

MODEL NO.	CABLE	CORD LENGTH
SWH24-8-E	UL2468, 20 AWG	1,830 mm \pm 100
SWH24-9-E	UL2468, 20 AWG	1,830 mm \pm 100
SWH24-11-E	UL2468, 20 AWG	1,830 mm \pm 100
SWH24-12-E	UL2468, 20 AWG	1,830 mm \pm 100
SWH24-15-E	UL2468, 20 AWG	1,830 mm \pm 100
SWH24-18-E	UL2468, 20 AWG	1,830 mm \pm 100
SWH24-19-E	UL2468, 20 AWG	1,830 mm \pm 100
SWH24-24-E	UL2468, 20 AWG	1,830 mm \pm 100
SWH24-28-E	UL2468, 20 AWG	1,830 mm \pm 100
SWH24-36-E	UL2468, 20 AWG	1,830 mm \pm 100
SWH24-40-E	UL2468, 20 AWG	1,830 mm \pm 100

DC PLUG TYPE PART NUMBER KEY

XXX

Plug Polarity:
P = Center Positive

N = Center Negative

Plug Code:
X = Choose a code from the options below

Plug Angle:
"blank" = Straight
R = Right Angle

Plug Polarity		Code		Dimensions (mm)			Plug Angle	
Center Pos.	Center Neg.	Option	Type	A	B	C	Straight	Right
•	•	5	Standard	5.5	2.1	9.5	•	•
•	•	6	Standard	5.5	2.5	9.5	•	•
•	•	7	Standard	3.5	1.35	9.5	•	•
•	•	10	Locking ²	5.5	2.1	9.5	•	N/A
•	•	11	Locking ²	5.5	2.5	9.5	•	N/A
•	•	12	EIAJ-1	2.35	0.7	9.5	•	•
•	•	13	EIAJ-2	4.0	1.7	9.5	•	•
•	•	14	EIAJ-3	4.75	1.7	9.5	•	•
N/A	N/A	ST	Stripped and Tinned				•	N/A
N/A	N/A	CUB	USB	USB Type C			•	N/A
N/A	N/A	MUB	USB	Micro USB Type B			•	N/A

Note: 1. Contact CUI for additional plug options.
2. Maximum insertion depth is 10mm.

Standard

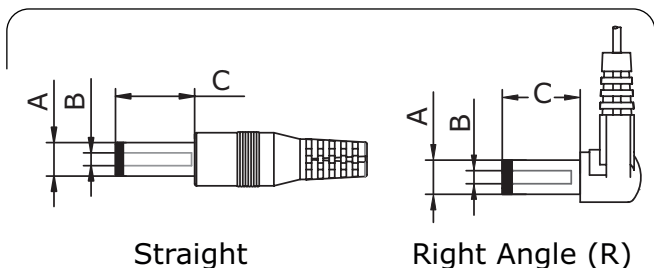

EIAJ

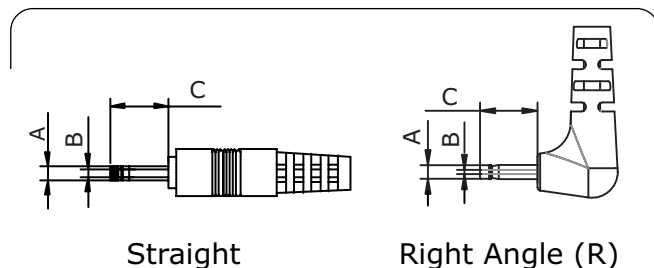

Locking

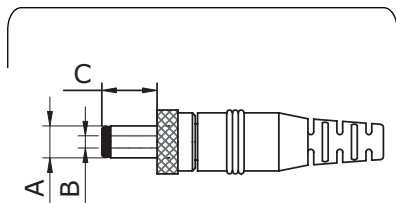

Stripped & Tinned

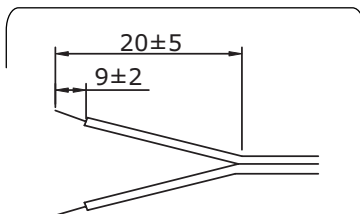

USB

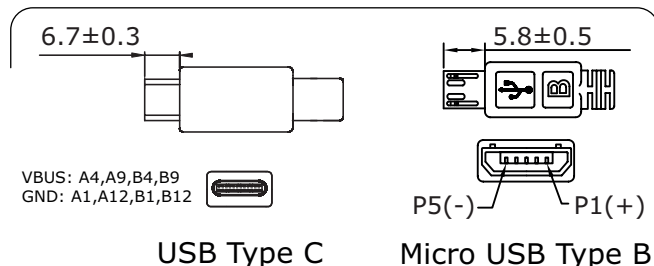

REVISION HISTORY

rev.	description	date
1.0	initial release	12/19/2022
1.01	stripped and tinned option added to dc plug types	01/18/2023
1.02	dc cord updated	02/03/2023

The revision history provided is for informational purposes only and is believed to be accurate.



CUI INC

a bel group

Headquarters
20050 SW 112th Ave.
Tualatin, OR 97062
800.275.4899

Fax 503.612.2383
cui.com
techsupport@cui.com

This device complies with part 15 of the FCC Rules. Operation is subject to the following two conditions:

- (1) This device may not cause harmful interference, and
- (2) this device must accept any interference received, including interference that may cause undesired operation.

CUI offers a one (1) year limited warranty. Complete warranty information is listed on our website.

CUI reserves the right to make changes to the product at any time without notice. Information provided by CUI is believed to be accurate and reliable. However, no responsibility is assumed by CUI for its use, nor for any infringements of patents or other rights of third parties which may result from its use.

CUI products are not authorized or warranted for use as critical components in equipment that requires an extremely high level of reliability. A critical component is any component of a life support device or system whose failure to perform can be reasonably expected to cause the failure of the life support device or system, or to affect its safety or effectiveness.