

Data sheet | Item number: 2091-1708

THT male header; 1.0 mm Ø solder pin; straight; Pin spacing 3.5 mm; 8-pole;
black

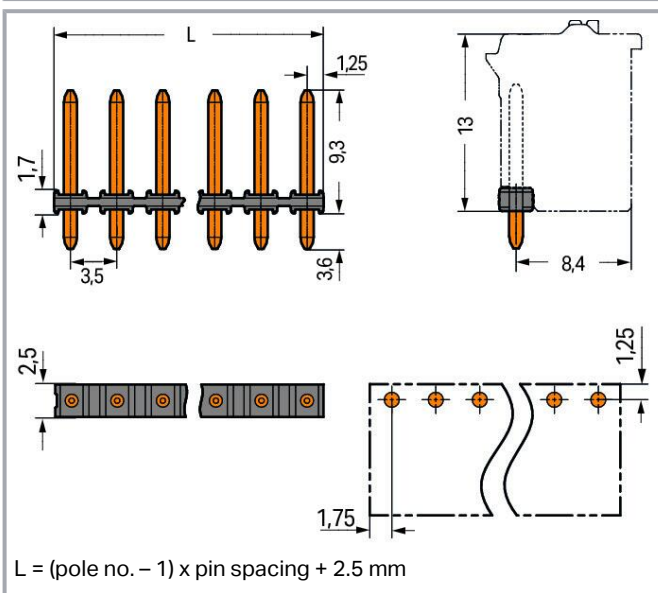

www.wago.com/2091-1708

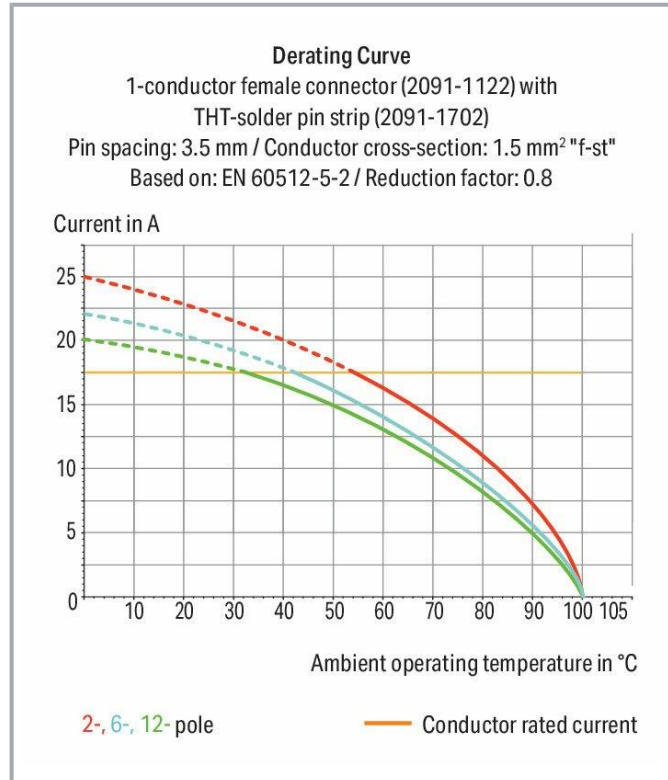
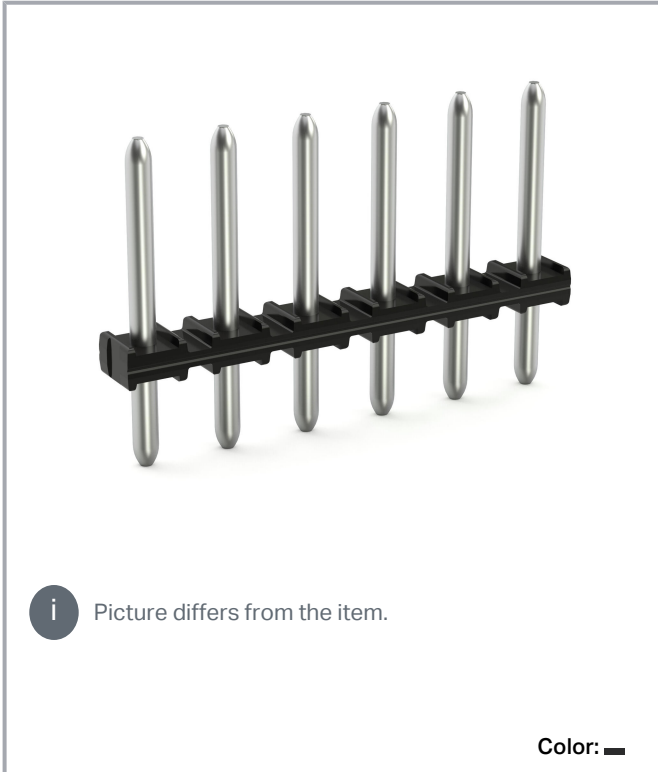

Subject to changes. Please also observe the further product documentation!

WAGO GmbH & Co. KG
Hansastr. 27
32423 Minden
Phone: +49571 887-0 | Fax: +49571 887-169
Email: info.de@wago.com | Web: www.wago.com

Do you have any questions about our products?
We are always happy to take your call at +49 (571) 887-44222.



Item description

- Solder pin strips may be mounted horizontally or vertically via straight or angled solder pins
- Assembly of female connectors without loss of poles, allowing different functions to be divided within one solder pin strip

Data

Notes

Safety information

The **picoMAX® Pluggable Connection System** includes connectors without breaking capacity in accordance with DIN EN 61984. When used as intended, these connectors must not be connected /disconnected when live or under load. The circuit design should ensure header pins, which can be touched, are not live when unmated.

Electrical data

Ratings per IEC/EN

Ratings per	IEC/EN 60664-1
Nominal voltage (III/3)	160 V
Rated impulse voltage (III/3)	2.5 kV
Rated voltage (III/2)	160 V
Rated impulse voltage (III/2)	2.5 kV
Nominal voltage (II/2)	320 V
Rated surge voltage (II/2)	2.5 kV
Rated current	10 A
Legend (ratings)	(III / 2) ≙ Overvoltage category III / Pollution degree 2

Connection data

Number of connection types	1
Number of levels	1

Connection 1

Pole number	8
-------------	---

Physical data

Pin spacing	3.5 mm / 0.138 inches
-------------	-----------------------

Subject to changes. Please also observe the further product documentation!



Width	29.5 mm / 1.161 inches
Height	12.9 mm / 0.508 inches
Height from the surface	9.3 mm / 0.366 inches
Depth	2.5 mm / 0.098 inches
Solder pin length	3.6 mm
Solder pin diameter	1 mm
Drilled hole diameter with tolerance	1.2 ^(+0.1) mm

Mechanical Data

Variable coding	Yes
Anti-rotation protection	Yes

Plug-in connection

Contact type (pluggable connector)	Male connector/plug
Connector (connection type)	for PCB
Mismating protection	No
Plugging without loss of pin spacing	Yes
Mating direction to the PCB	90 °
Locking of plug-in connection	none

PCB contact

PCB contact	THT
-------------	-----

Material Data

Note (material data)	Information on material specifications can be found here
Color	black
Material group	I
Insulation material	Polyphthalamide (PPA GF)
Flammability class per UL94	V0
Contact material	Electrolytic copper (E _{Cu})
Contact plating	Tin
Weight	0.8 g

Subject to changes. Please also observe the further product documentation!

Environmental requirements

Limit temperature range	-60 ... +100 °C
-------------------------	-----------------

Commercial data





ETIM 8.0	EC002637
ETIM 7.0	EC002637
PU (SPU)	500 pcs
Packaging type	bag
Country of origin	CN
GTIN	4055143934787
Customs tariff number	85369010000

Environmental Product Compliance

RoHS Compliance Status	Compliant, No Exemption
------------------------	-------------------------

Approvals / Certificates

General approvals

Logo	Approval	Additional Approval Text	Certificate name
	CB DEKRA Certification B.V.	IEC 61984	NL-49736 /A1
	CSA DEKRA Certification B.V.	C22.2	2362521
	KEMA/KEUR DEKRA Certification B.V.	EN 61984	71- 102260 REV.1
	UL Underwriters Laboratories Inc.	UL 1977	E45171
	UL Underwriters Laboratories Inc.	UL 1059	E45172

Subject to changes. Please also observe the further product documentation!

Counterpart



Item no.2091-1128

1-conductor female connector; push-button; Push-in CAGE CLAMP®; 1.5 mm²; Pin spacing 3.5 mm; 8-pole; 1,50 mm²; light gray

www.wago.com/2091-1128

Downloads

Documentation

Additional Information

Technical Section	2019 Apr 3	pdf	Download
Technical explanations		2.0 MB	

CAD/CAE-Data

CAD data

2D/3D Models 2091-1708	URL	Download
------------------------	-----	----------

CAE data

ZUKEN Portal 2091-1708	URL	Download
------------------------	-----	----------

Environmental Product Compliance

Compliance Search

Environmental Product Compliance 2091-1708	URL	Download
THT male header; 1.0 mm Ø solder pin; straight; Pin spacing 3.5 mm; 8-pole; black		

Installation Notes

Subject to changes. Please also observe the further product documentation!