

Data sheet | Item number: 770-315

Plug; with strain relief housing; 5-pole; Cod. A; 4,00 mm²; black

www.wago.com/770-315

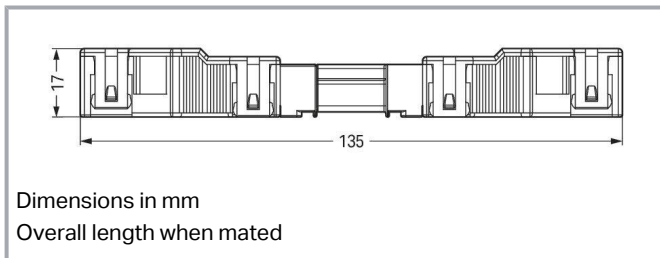
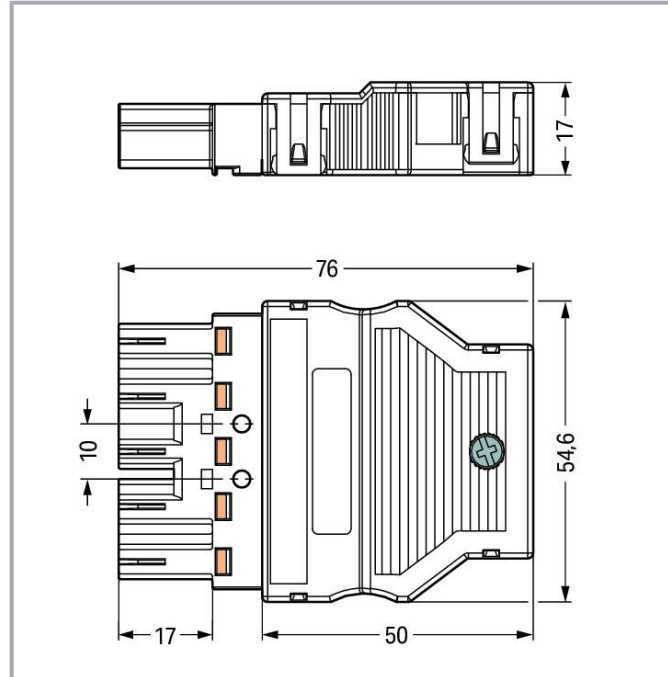

Item description

Male connector/plug WINSTA® MIDI 5-pole

The WINSTA® MIDI male connector/plug with protection against mismatching allows assembly of solid and fine-stranded conductors. Our pluggable installation connectors with spring pressure connection technology function without screw connections. They allow fast, efficient, error-free installation in numerous applications. The coding options reduce installation errors, allowing fast, maintenance-free wiring of all components. The pluggable installation connector is protected against ingress by solid objects in accordance with protection type IP20 (When mated and secured with a strain relief housing: IP2xC (These compact connectors are not designed for use in open, easily accessible areas!)). Thanks to the color coding and mechanical A coding of WINSTA® MIDI pluggable installation connectors, you can clearly distinguish different circuits. This pluggable

Subject to changes. Please also observe the further product documentation!

WAGO GmbH & Co. KG
Hansastr. 27
32423 Minden
Phone: +49571 887-0 | Fax: +49571 887-169
Email: info.de@wago.com | Web: www.wago.com

Do you have any questions about our products?
We are always happy to take your call at +49 (571) 887-44222.



installation connector can be used for a voltage load of up to 25 A. Thus, it can also be used for high power loads. The *WINSTA*® MIDI Pluggable Connection System with Push-in CAGE CLAMP® spring pressure connection technology facilitates safe electrification. Due to the integrated test slot, it is possible to check connections even when they are plugged in. This saves time, labor, and money. The strip length is 55 mm.

Lower costs through fast commissioning and elimination of service expenses – solutions from *WINSTA*® MIDI

The *WINSTA*® Pluggable Connection System allows pluggable electrical installation. This saves time, lowers costs, and reduces the need for servicing. Now you can also lower installation expenses without compromising quality and safety: The *WINSTA*® MIDI pluggable installation connector with marking reduces the need for servicing and prevents unnecessary downtime.

- effective protection against mismatching
- pre-assembled versions
- with A coding for a great number of applications
- ready for immediate use
- fast, secure installation

Data

Electrical data

Ratings per IEC/EN

Ratings per	IEC/EN 60664-1
Nominal voltage (III/3)	400 V
Rated impulse voltage (III/3)	6 kV
Rated current	25 A
Legend (ratings)	(III / 3) ± Overvoltage category III / Pollution degree 3

Ratings per UL 1977

Note for the US market	Some versions may also be used for current interruption in accordance with the UL certificate in select applications with currents below 16 A and voltages up to 600 V. For further information, please contact your local sales office.
Rated voltage (UL 1977)	600 V
Rated current UL 1977	23 A

General

Note on contact resistance approx. 1 mΩ of contact resistance

Subject to changes. Please also observe the further product documentation!

WAGO GmbH & Co. KG
 Hansastr. 27
 32423 Minden
 Phone: +49571 887-0 | Fax: +49571 887-169
 Email: info.de@wago.com | Web: www.wago.com

Do you have any questions about our products?
 We are always happy to take your call at +49 (571) 887-44222.



approx. 0.25 mΩ contact transition plug/socket

Connection data

Connection points	5
Total number of potentials	5
PE function	Preceding PE contact

Connection 1

Connection technology	Push-in CAGE CLAMP®
Actuation type	Operating tool Push-in
Nominal cross-section	4 mm ² / 12 AWG
Solid conductor	0.5 ... 4 mm ² / 20 ... 12 AWG
Solid conductor; push-in termination	1.5 ... 4 mm ² / 16 ... 12 AWG
Stranded conductor	0.5 ... 2.5 mm ² / 20 ... 14 AWG
Fine-stranded conductor	0.5 ... 4 mm ² / 20 ... 12 AWG
Fine-stranded conductor; with insulated ferrule	0.25 ... 1.5 mm ² / 20 ... 16 AWG
Fine-stranded conductor; with uninsulated ferrule	0.25 ... 2.5 mm ² / 20 ... 14 AWG
Fine-stranded conductor; with ferrule; push-in termination	1.5 mm ² / 16 AWG
Strip length	9 mm / 0.35 inches
Pole number	5
Conductor entry direction to mating direction	0°
Strip length (outer insulation)	55 mm

Physical data

Pin spacing	10 mm / 0.394 inches
Width	54.6 mm / 2.15 inches
Height	17 mm / 0.669 inches
Depth	76 mm / 2.992 inches

Mechanical Data

Application	General mains applications
Coding	A
Variable coding	Yes
Marking	L3 L2 L1 ⚡ N
Potential marking	L3 L2 L1 ⚡ N

Subject to changes. Please also observe the further product documentation!



Mating force of a plug-in connection	approx. 20 ... 70 N (depending on pole number)
Retention force of a plug-in connection	Locked: > 80 N
Unmating force of a plug-in connection	Unlocked: approx. 20 ... 70 N (depending on pole number)
Number of mating cycles	200, without resistive load
Protection type	IP20; When mated and secured with a strain relief housing: IP2xC (These compact connectors are not designed for use in open, easily accessible areas!)

Plug-in connection

Contact type (pluggable connector)	Male connector/plug
Connector (connection type)	for conductor
Mismating protection	Yes
Note on mismating protection	All <i>WINSTA</i> [®] components are 100% protected against mismating when: a.) plugging different numbers of poles b.) plugging while rotated 180 c.) plugging while laterally staggered d.) plugging one pole
Locking lever	Can be retrofitted
Locking of plug-in connection	locking lever
Note on locking system	All connectors for mounted installations (snap-in versions for lighting fixtures or devices, all types of PCB and distribution connectors) are factory-equipped with locking levers to ensure plugs and sockets are securely locked. Additional locking levers are only required for flying leads (plug/socket).
Strain relief	strain relief housing

Material Data

Note (material data)	Information on material specifications can be found here
Color	black
Cover color	gray
Material group	I
Insulation material	Polyamide (PA66)
Flammability class per UL94	V0
Clamping spring material	Chrome-nickel spring steel (CrNi)
Contact material	Copper or copper alloy; surface-treated
Contact plating	Tin
Fire load	0.752 MJ

Subject to changes. Please also observe the further product documentation!

Weight	29.8 g
--------	--------

Environmental requirements

Processing temperature	-5 ... +40 °C
Continuous operating temperature	-35 ... +85 °C
Note on continuous operating temperature	Insulating parts for temperatures ≤ 105 °C

Commercial data



Product Group	20 (Winsta)
eCl@ss 10.0	27-44-06-05
eCl@ss 9.0	27-44-06-05
ETIM 8.0	EC002560
ETIM 7.0	EC002560
PU (SPU)	25 pcs
Packaging type	box
Country of origin	DE
GTIN	4044918254663
Customs tariff number	85366990990

Environmental Product Compliance

RoHS Compliance Status	Compliant, No Exemption
------------------------	-------------------------

Approvals / Certificates

General approvals

Logo	Approval	Additional Approval Text	Certificate name
	CCA DEKRA Certification B.V.	IEC 61535	NL -84761
	CCA DEKRA Certification B.V.	EN 61535	71- 123228
	cURus Underwriters Laboratories Inc.	UL 1977	E45171
	VDE VDE Prüf- und Zertifizierungsinstitut	EN 61984	40002889



Subject to changes. Please also observe the further product documentation!







Declarations of conformity and manufacturer's declarations

Logo	Approval	Additional Approval Text	Certificate name
	EU-Declaration of Conformity WAGO GmbH & Co. KG	-	-

Approvals for marine applications

Logo	Approval	Additional Approval Text	Certificate name
	ABS American Bureau of Shipping	-	19- HG1868589- PDA
	DNV GL Det Norske Veritas, Germanischer Lloyd	-	TAE00001Z6
	LR Lloyds Register	IEC 61984	LR22429487TA

Counterpart

	Item no.770-105 Socket; with strain relief housing; 5-pole; Cod. A; 4,00 mm ² ; black	www.wago.com/770-105
	Item no.770-205 Socket; 5-pole; Cod. A; 4,00 mm ² ; black	www.wago.com/770-205
	Item no.770-305 Socket; with strain relief housing; 5-pole; Cod. A; 4,00 mm ² ; black	www.wago.com/770-305
	Item no.770-405 Socket; 5-pole; Cod. A; 4,00 mm ² ; black	www.wago.com/770-405
	Item no.770-611 Three-phase to single-phase distribution connector; with phase selection; 5-pole/3-pole; Cod. A; 1 input; 2 outputs; with cable connection on the input side; black	www.wago.com/770-611

Subject to changes. Please also observe the further product documentation!



Item no.770-609
3-way distribution connector; 5-pole; Cod. A; 1 input; 3 outputs; black

www.wago.com/770-609



Item no.770-621
T-distribution connector; 5-pole; Cod. A; 1 input; 2 outputs; 2 locking levers; black

www.wago.com/770-621



Item no.770-622
T-distribution connector; 5-pole; Cod. A; 1 input; 2 outputs; 3 locking levers; for flying leads; black

www.wago.com/770-622



Item no.770-640
Three-phase to single-phase distribution connector; with phase selection; 5-pole/3-pole; Cod. A; 1 input; 5 outputs; black

www.wago.com/770-640



Item no.770-659
3-way distribution connector; 5-pole; Cod. A; 1 input; 3 outputs; white

www.wago.com/770-659



Item no.770-805
Socket for PCBs; straight; 5-pole; Cod. A; black

www.wago.com/770-805



Item no.770-705
Snap-in socket; 5-pole; Cod. A; 4,00 mm²; black

www.wago.com/770-705



Item no.770-705/009-000
Snap-in socket; with protruding mating face; 5-pole; Cod. A; 4,00 mm²; black

www.wago.com/770-705/009-000



Item no.770-805/011-000
Socket for PCBs; angled; 5-pole; Cod. A; black

www.wago.com/770-805/011-000



Item no.771-9995/006-101
pre-assembled interconnecting cable; Eca; Socket/plug; 5-pole; Cod. A; H05VV-F 5G 1.5 mm²; 1 m; 1,50 mm²; black

www.wago.com/771-9995/006-101



Item no.771-9995/106-101
pre-assembled connecting cable; Eca; Socket/open-ended; 5-pole; Cod. A; H05VV-F 5G 1.5 mm²; 1 m; 1,50 mm²; black

www.wago.com/771-9995/106-101



Item no.772-262
Tap-off module; for flat cable; 5 x 2.5 mm² + 2 x 1.5 mm²; 5-pole; Cod. A; with cable connection on the output side; black

www.wago.com/772-262

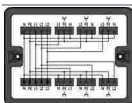

Item no.899-631/100-000
Distribution box; Three-phase to single-phase current (400 V/230 V); 1 input; 7 outputs; Cod. A; MIDI; black

www.wago.com/899-631/100-000

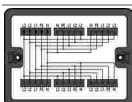

Item no.899-631/187-000
Distribution box; Three-phase current (400 V); 1 input; 5 outputs; Cod. A; MIDI; black

www.wago.com/899-631/187-000

Subject to changes. Please also observe the further product documentation!

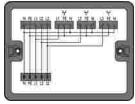

Item no.899-631/346-000

Distribution box; Three-phase to single-phase current (400 V/230 V); 1 input; 4 outputs; Cod. A; MIDI; black

[www.wago.com/899-](http://www.wago.com/899-631/346-000)

[631/346-000](http://www.wago.com/899-631/346-000)

Required accessories

Locking levers

Locking system



Item no.: 770-121

Locking lever; for flying leads; for manual operation; white

www.wago.com/770-121



Item no.: 770-131

Locking lever; for flying leads; for tool operation; white

www.wago.com/770-131



Item no.: 770-101

Locking lever; for flying leads; for manual operation; black

www.wago.com/770-101



Item no.: 770-111

Locking lever; for flying leads; for tool operation; black

www.wago.com/770-111

Optional accessories

Cover

Cover



Item no.: 770-360

Lockout cap; for plugs; 5-pole; separable; yellow

www.wago.com/770-360



Item no.: 897-2005

Protective cap; Type4; for sockets and plugs; PVC; red

www.wago.com/897-2005

Tool

Wiring aid



Item no.: 770-100

Wiring aid; 2- to 5-pole; Plastic; orange

www.wago.com/770-100

Operating tool



Item no.: 210-719

Operating tool; Blade: 2.5 x 0.4 mm; with a partially insulated shaft

www.wago.com/210-719

Marking accessories

Subject to changes. Please also observe the further product documentation!

WAGO GmbH & Co. KG

Hansastr. 27

32423 Minden

Phone: +49571 887-0 | Fax: +49571 887-169

Email: info.de@wago.com | Web: www.wago.com

Do you have any questions about our products?

We are always happy to take your call at +49 (571) 887-44222.

Marker



Item no.: 770-450/000-002
Marker card; Plastic; yellow

www.wago.com/770-450/000-002



Item no.: 770-450/000-001
Marker card; Plastic; green

www.wago.com/770-450/000-001



Item no.: 770-450/000-005
Marker card; Plastic; red

www.wago.com/770-450/000-005



Item no.: 770-450
Marker card; Plastic; white

www.wago.com/770-450



Item no.: 770-450/000-006
Marker card; Plastic; blue

www.wago.com/770-450/000-006



Item no.: 770-450/000-012
Marker card; Plastic; orange

www.wago.com/770-450/000-012

Coding

Coding



Item no.: 770-401
Coding pin; for plugs; Plastic; gray

www.wago.com/770-401

Downloads

Documentation

Bid Text

770-315 X81 - Datei	2019 Feb 19	xml 3.1 kB	Download
770-315 doc - Datei	2015 Jun 8	doc 24.1 kB	Download

Subject to changes. Please also observe the further product documentation!

CAD/CAE-Data

CAD data

2D/3D Models 770-315	URL	Download
----------------------	---------------------	--------------------------

CAE data

EPLAN Data Portal 770-315	URL	Download
---------------------------	---------------------	--------------------------

ZUKEN Portal 770-315	URL	Download
----------------------	---------------------	--------------------------

WSCAD Universe 770-315	URL	Download
------------------------	---------------------	--------------------------

Environmental Product Compliance

Compliance Search

Environmental Product Compliance 770-315	URL	Download
--	---------------------	--------------------------

Plug; with strain relief housing; 5-pole; Cod. A; 4,00 mm²; black

Installation Notes

Conductor termination

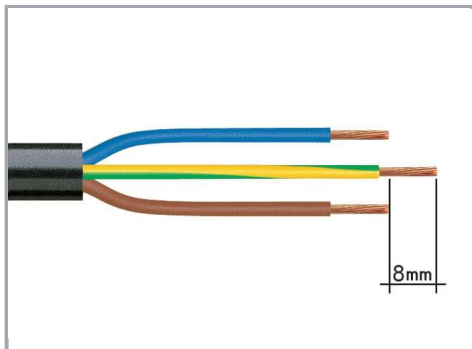

1. Strip length, outer insulation = 35 mm (2-pole), 55 mm (3- to 5-pole)

2. Strip length = 9 mm

3. Extended ground conductor = 8 mm

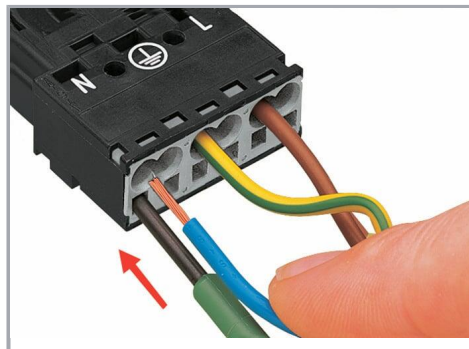

To terminate fine-stranded conductors, open the clamping unit via screwdriver (2.5 mm blade width) and insert a stripped conductor until it hits the backstop.

Subject to changes. Please also observe the further product documentation!

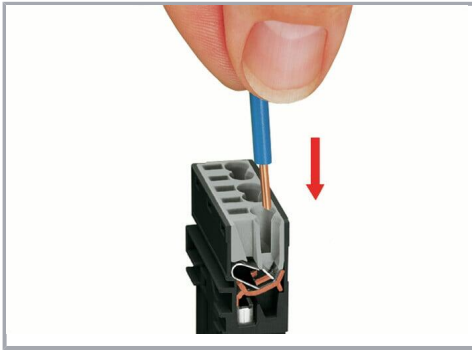

Insert the stripped solid conductor until it hits the backstop.

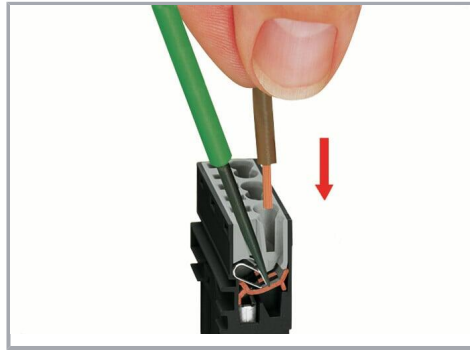

To terminate fine-stranded conductors, open the clamping unit via screwdriver (2.5 mm blade width) and insert a stripped conductor until it hits the backstop.

Conductor removal

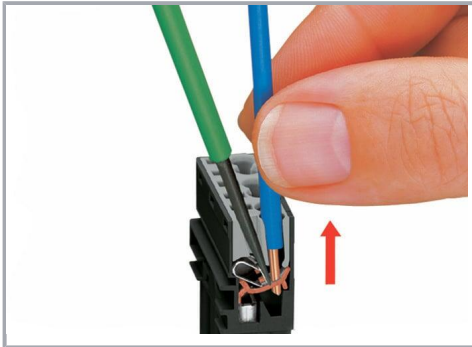

To remove the conductor, actuate the clamp via screwdriver (2.5 mm blade width) and pull out the conductor.

Installation

Subject to changes. Please also observe the further product documentation!

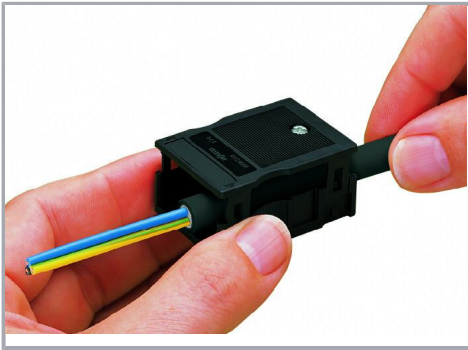

We recommend pulling the pre-latched strain relief housing over the cable prior to termination. However, the strain relief can be mounted at a later time as well.



Latch the strain relief housing onto the plug /socket. Note the "TOP" inscription.

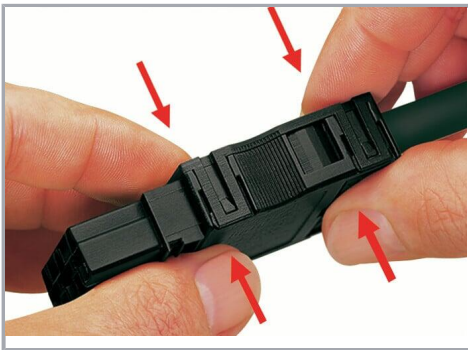

Prepare strain relief housing by snapping together upper and bottom part.



Tighten strain relief screw with screwdriver (2.5 mm blade width).

Product family

WINSTA® MIDI

[Show all products from the family](#)

Subject to changes. Please also observe the further product documentation!