

## Ultra-slim and Amplifier Built-in Type

### ■ Features

- Ultra-thin size of only 3.7mm
  - W13 × H19 × L3.7mm (through-beam type)
  - W13 × H24 × L3.7mm (diffuse reflective type, BGS reflective type)
- Detection methods and minimum target size
  - Through-beam type (BTF1M): Ø2mm
  - Diffuse reflective type (BTF30): Ø0.2mm (at distance 10mm)
  - BGS reflective type (BTF15): Ø0.2mm (at distance 10mm)
- Detecting distance may vary by environmental factors
- Maximum detection distance: 1m (through-beam type)
- Stability indicator (green LED) and operation indicator (red LED)
- Stainless steel 304 mounting brackets
- IP67 protection structure (IEC standard)

**⚠ Please read "Safety Considerations" in the instruction manual before using.**

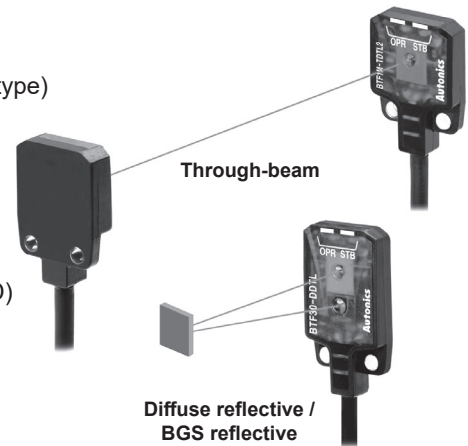

### ■ Specifications

Model	NPN open collector output		BTF1M-TDTL		BTF1M-TDTD		BTF30-DDTL		BTF30-DDTD		BTF15-BDTL		BTF15-BDTD	
	PNP open collector output		BTF1M-TDTL-P		BTF1M-TDTD-P		BTF30-DDTL-P		BTF30-DDTD-P		BTF15-BDTL-P		BTF15-BDTD-P	
Sensing type	Through-beam				Diffuse reflective				BGS reflective					
Sensing distance	1m				5 to 30mm <sup>※1</sup>				1 to 15mm <sup>※1</sup>					
Sensing target	Opaque material over Ø2mm				Translucent, opaque materials									
Min. sensing target	Opaque material of Ø2mm				Ø0.2mm (sensing distance 10mm)				Ø0.2mm non-illuminated objects (sensing distance 10mm)					
Hysteresis	—				Max. 20% at sensing distance				Max. 5% at sensing distance					
Reflectivity characteristics (black/white error)	—				—				Max. 15% of maximum sensing distance					
Response time	Max. 1ms													
Power supply	12-24VDC $\pm$ 10% (ripple P-P: max. 10%)													
Current consumption	Max. 20mA (this is for each emitter and receiver of through-beam type.)													
Light source	Red LED (650nm)													
Operation mode	Light ON		Dark ON		Light ON		Dark ON		Light ON		Dark ON			
Control output	NPN or PNP open collector output • Load voltage: max. 26.4VDC $\pm$ • Load current: max. 50mA • Residual voltage - NPN: max. 1VDC $\pm$ , PNP: max. 2VDC													
Protection circuit	Power reverse polarity protection circuit, output short over current protection circuit													
Indicator	Operation indicator: red LED, stability indicator: green LED													
Connection	Cable type													
Insulation resistance	Over 20MΩ (at 500VDC megger)													
Noise immunity	$\pm$ 240V the square wave noise (pulse width: 1μs) by the noise simulator													
Dielectric strength	1,000VAC 50/60Hz for 1 minute													
Vibration	1.5mm amplitude at frequency of 10 to 55Hz in each X, Y, Z direction for 2 hours													
Shock	500m/s <sup>2</sup> (approx. 50G) in each X, Y, Z direction for 3 times													
Environment	Ambient illumination	Sunlight: max. 10,000lx, incandescent lamp: max. 3,000lx (receiver illumination)												
	Ambient temperature	-25 to 55°C, storage: -40 to 70°C												
	Ambient humidity	35 to 85%RH, storage: 35 to 85%RH												
Protection	IP67 (IEC standards)													
Material	Case: polybutylene terephthalate, sensing part: polymethyl methacrylate, bracket: SUS304 (steel use stainless 304), bolt: carbon steel, sleeve: SUS304 (steel use stainless 304)													
Cable	Ø2.5mm, 3P, 2m (emitter of through-beam type: Ø2.5mm, 2P, 2m) (AWG 28, core diameter: 0.08mm, number of core: 19, insulator out diameter: Ø0.9mm)													
Accessory	Fixing bracket, M2 bolt: 4				Fixing bracket, M2 bolt: 2									
Approval	<b>CE</b>													
Weight <sup>※2</sup>	Approx. 70g (approx. 40g)				Approx. 40g (approx. 25g)									

※1: Non-glossy white paper 50×50mm.

※2: The weight includes packaging. The weight in parenthesis is for unit only.

※The temperature or humidity mentioned in Environment indicates a non freezing or condensation.

SENSORS

CONTROLLERS

MOTION DEVICES

SOFTWARE

(A) Photoelectric Sensors

(B) Fiber Optic Sensors

(C) LIDAR

(D) Door/Area Sensors

(E) Vision Sensors

(F) Proximity Sensors

(G) Pressure Sensors

(H) Rotary Encoders

(I) Connectors/ Connector Cables/ Sensor Distribution Boxes/ Sockets

# BTF Series

## ■ Feature Data

### ◎ Through-beam type

#### ● BTF1M-TDTL / BTF1M-TDTL-P

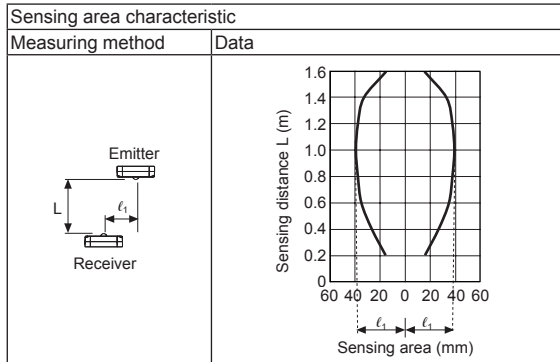

### ◎ Diffuse reflective type

#### ● BTF30-DDTL / BTF30-DDTL-P

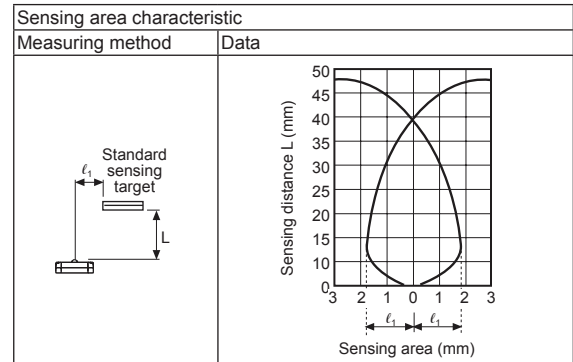

### ◎ BGS reflective type

#### ● BTF15-BDTL / BTF15-BDTL-P

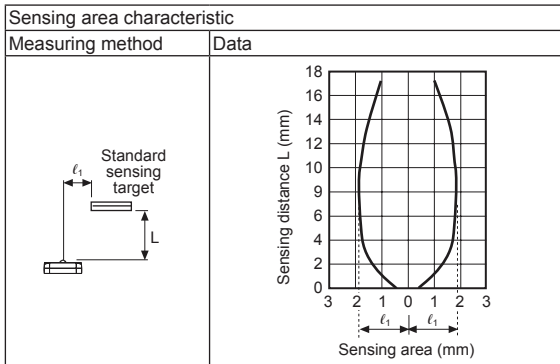

### Sensing distance by material

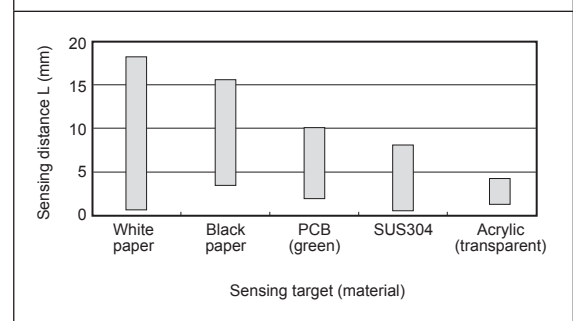

## ■ Connections

### ● Through-beam type

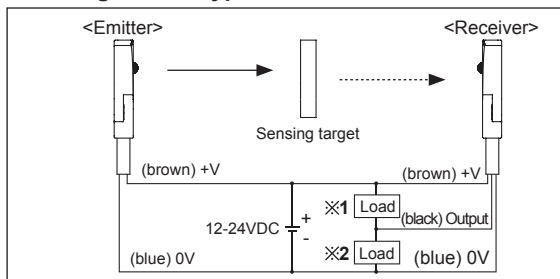

### ● Diffuse reflective/BGS reflective type

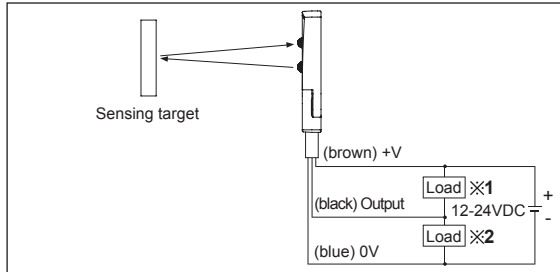

※1: Load connection for NPN output  
 ※2: Load connection for PNP output

## ■ Control Output Circuit Diagram

### ● NPN open collector output

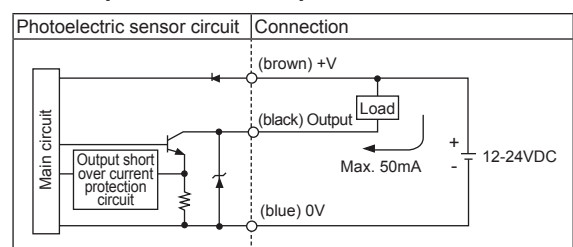



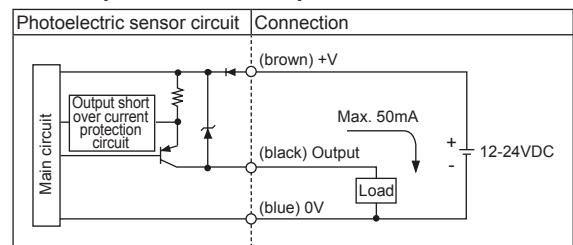







### ● PNP open collector output

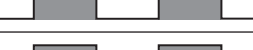
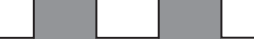

※ If short-circuit the control output terminal or supply current over the rated specification, normal control signal is not output due to the output short over current protection circuit.

# Ultra-slim and Amplifier Built-in Type

## ■ Operation Mode

Operation mode	Light ON	Dark ON
Receiver operation	Received light  Interrupted light 	Received light  Interrupted light 
Operation indicator (red LED)	ON  OFF 	ON  OFF 
Transistor output	ON  OFF 	ON  OFF 

## ■ Dimensions

(unit: mm)

### ● Through-beam type

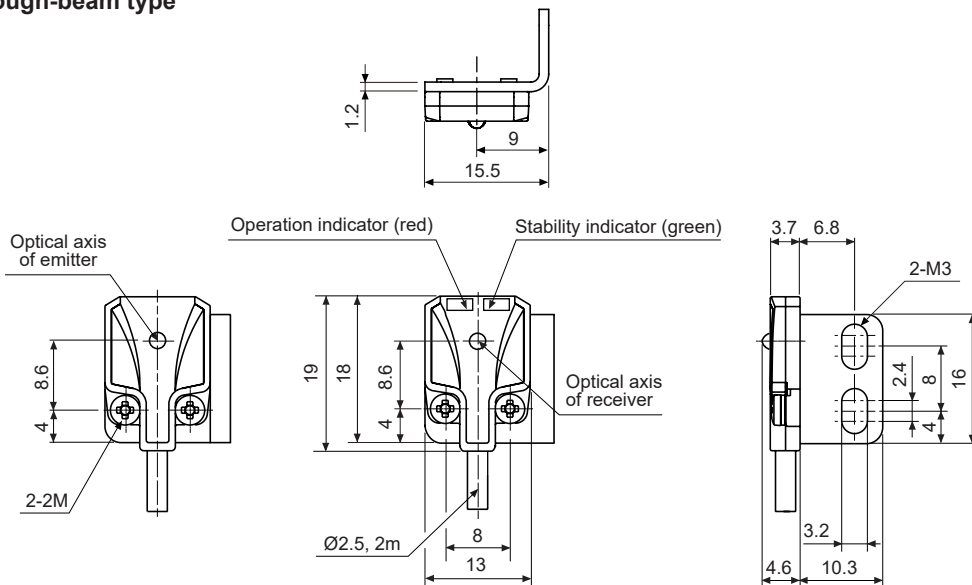

### ● Diffuse reflective/BGS reflective type

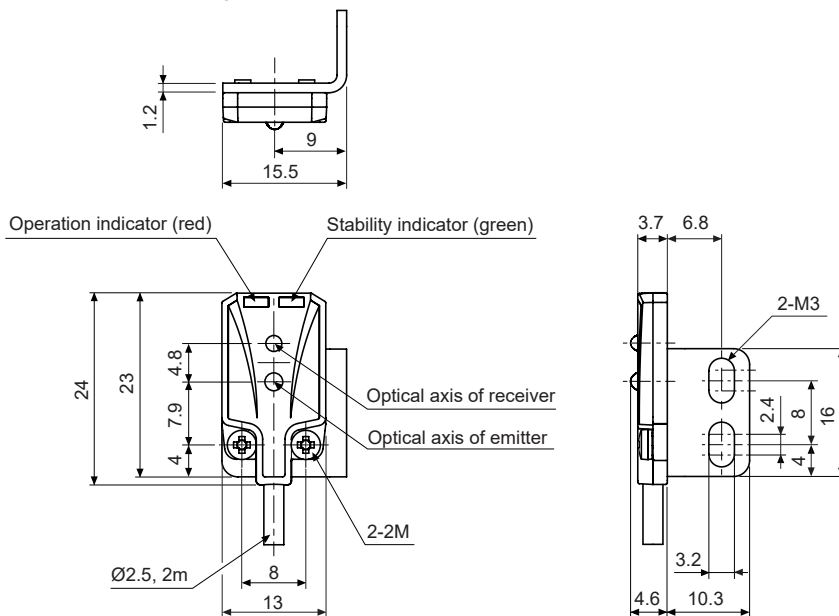

SENSORS

CONTROLLERS

MOTION DEVICES

SOFTWARE

(A) Photoelectric Sensors

(B) Fiber Optic Sensors

(C) LIDAR

(D) Door/Area Sensors

(E) Vision Sensors

(F) Proximity Sensors

(G) Pressure Sensors

(H) Rotary Encoders

(I) Connectors/  
Connector Cables/  
Sensor Distribution  
Boxes/ Sockets

# BTF Series

## ■ Operation Timing Diagram

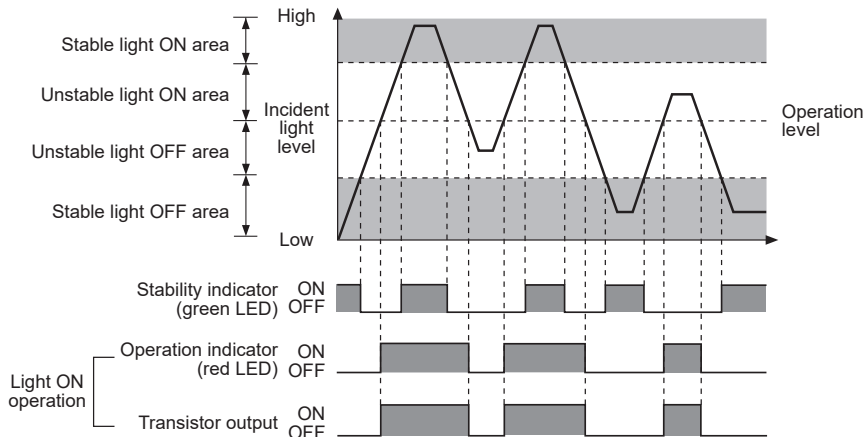

※The waveform of 'Operation indicator' and 'Transistor output' are for Light ON operation.  
The waveform are reversed for Dark ON operation.

## ■ Installation and Adjustment

### ◎ For mounting

When using photoelectric sensors closely over two units, it may result in malfunction due to mutual interference. When installing the product, tighten the screw with a tightening torque of 0.3N·m.

※Do not impact on the unit with hard objects and do not bend the cable part too much. It may cause damage to waterproof function.

#### ● Through-beam type

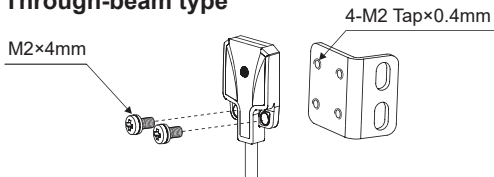

#### ● Diffuse reflective/BGS reflective type

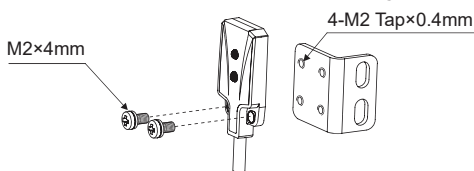

### ※ Notice for BGS reflective type

1) Make sure that the sensing side of this sensor is parallel with the surface of each sensing object.

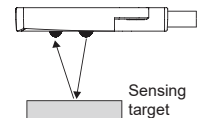

2) If the sensing object has glossy surface or high reflection, the sensor tilts from 5 to 10° as shown in the figure.

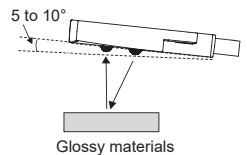

Make sure whether the sensor is influenced by any background objects.

3) Make sure to install the sensor in the proper direction with considering moving direction of sensing objects. Refer to the following.

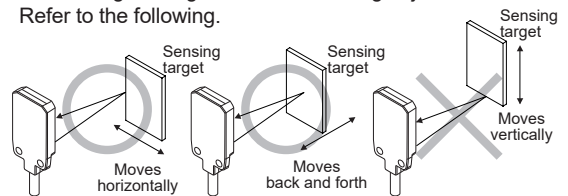

### ◎ Optical axis adjustment

#### ● Through-beam type

Set the emitter and the receiver facing each other and adjust these up-down, right-left after checking the point of operating the stability indicator. Fix the emitter and the receiver at the center of the point.

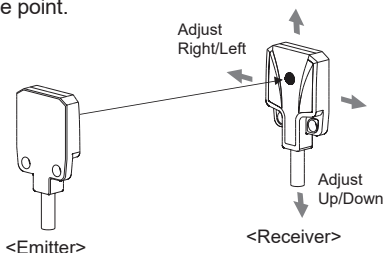

#### ● Diffuse reflective/BGS reflective type

After placing a sensing target, fix it in the middle of position where the stability indicator operates when adjusting the sensor to up-down, right-left. Make sure that the sensing side of the sensor is parallel with the surface of each sensing target.

