

GABRIELLA-45-M

~25° medium beam with holder and installation tape

SPECIFICATION:

Dimensions	Ø 45.0 mm
Height	29.2 mm
Fastening	tape
ROHS compliant	yes ⓘ

MATERIALS:

Component	Type	Material	Colour	Finish
C15810_GABRIELLA-45-M	Single lens	PMMA	clear	
CA15928_GABRIELLA-45-HLD-T	Assembly	PC	black	

ORDERING INFORMATION:

Quantities for one set:

Single lens	1
Assembly	1



Component		Qty in box	MOQ	MPQ	Box weight (kg)
C15810_GABRIELLA-45-M » Box size: 476 x 273 x 292 mm	Single lens	405	90	45	11.3
CA15928_GABRIELLA-45-HLD-T » Box size: 476 x 273 x 292 mm	Assembly	405	90	45	5.7

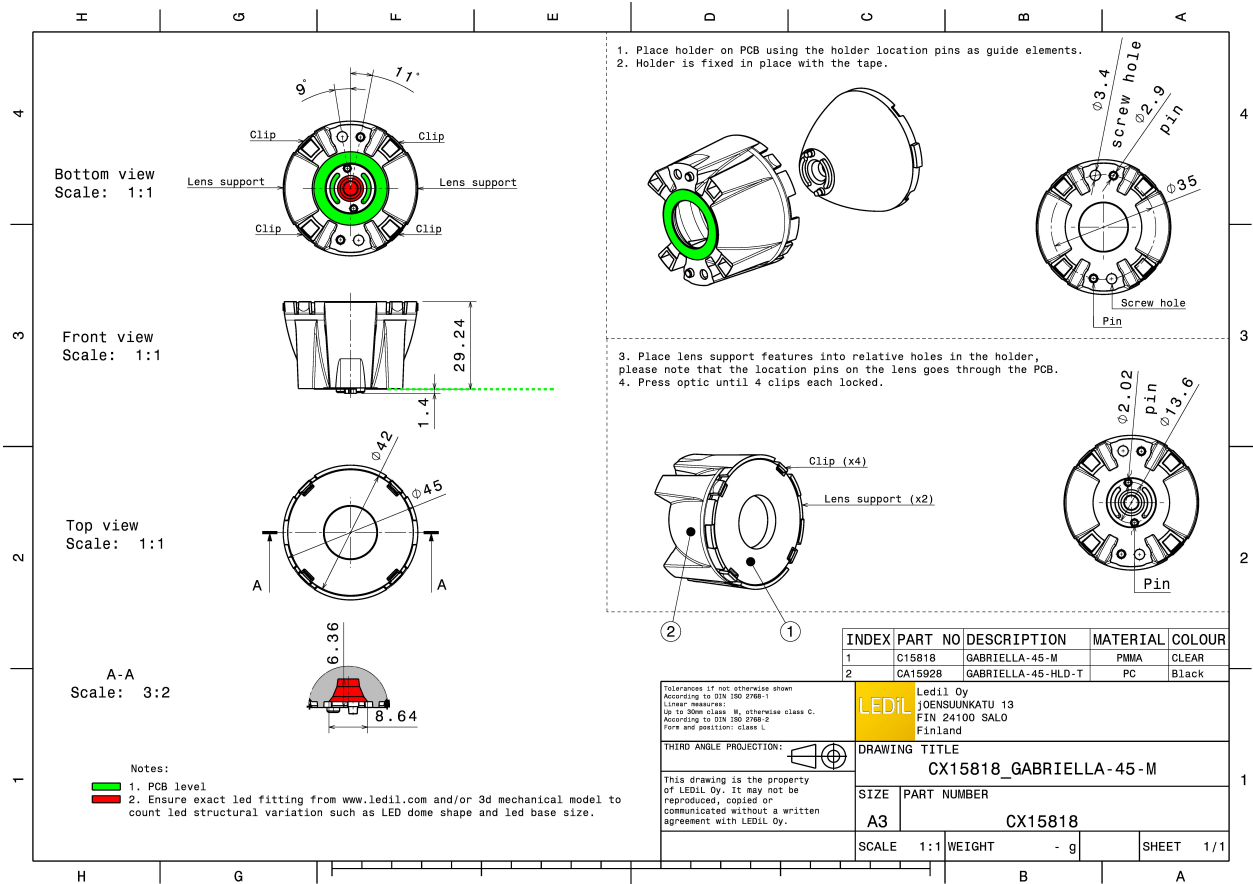

See also our general installation guide: www.ledil.com/installation_guide

OPTICAL RESULTS (MEASURED):

CREE LED

LED XM-L RGBW (XMLDCL HI)
 FWHM / FWTM 24.0° / 41.0°
 Efficiency 88 %
 Peak intensity 4.6 cd/m
 LEDs/each optic 1
 Light colour RGBW
 Required components:

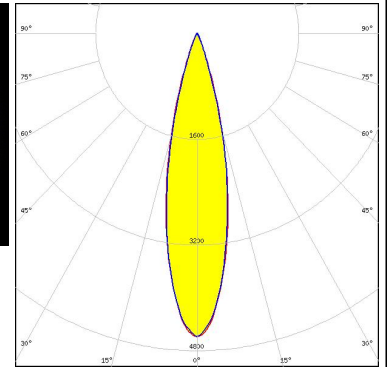
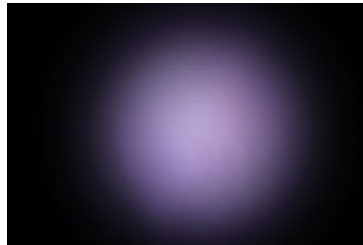

CREE LED

LED XQ-E HD
 FWHM / FWTM 24.0° / 43.0°
 Efficiency 86 %
 Peak intensity 4.3 cd/m
 LEDs/each optic 4
 Light colour RGBW
 Required components:

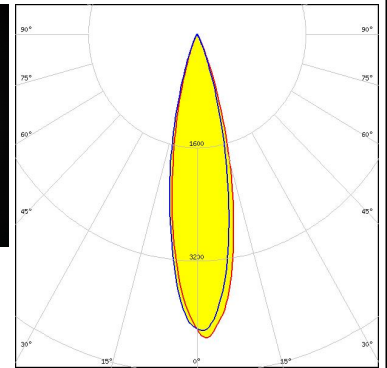
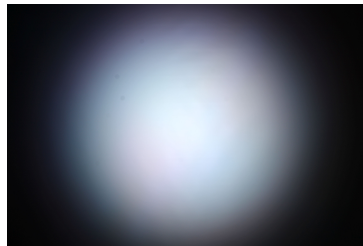

LUMILEDS

LED LUXEON CZ
 FWHM / FWTM 24.0° / 44.0°
 Efficiency 87 %
 Peak intensity 4.1 cd/m
 LEDs/each optic 4
 Light colour RGBW
 Required components:

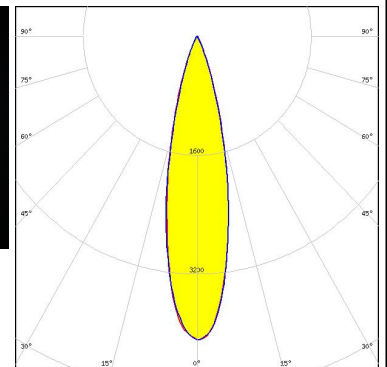
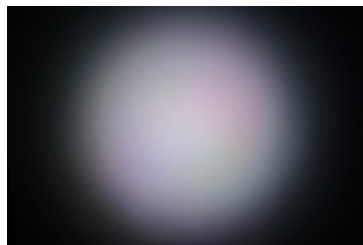



LUMINUS

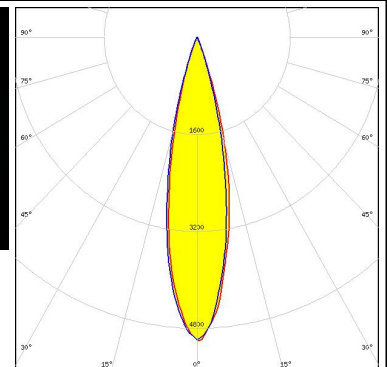
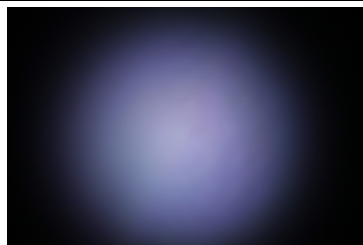

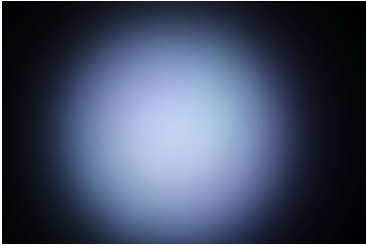
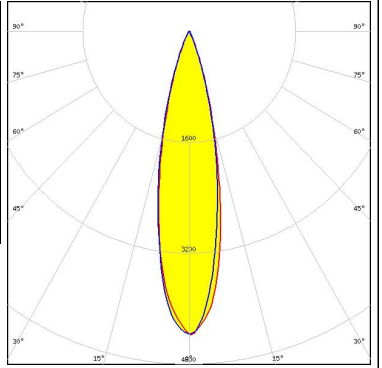
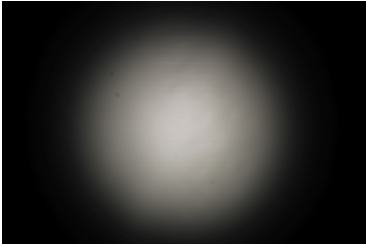
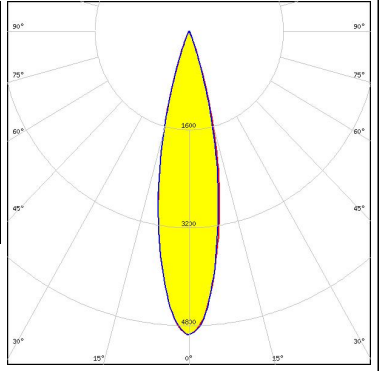
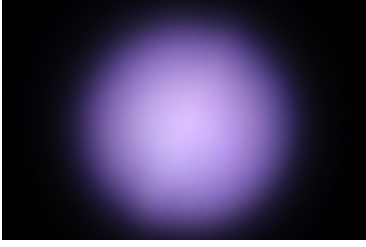
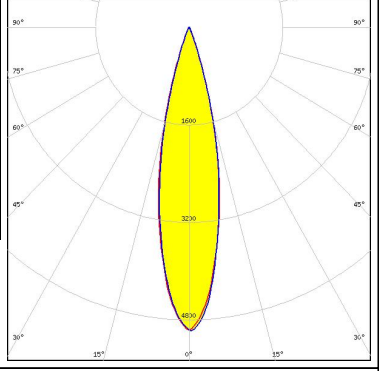

LED SBM-40-RGBW
 FWHM / FWTM 24.0° / 40.0°
 Efficiency 89 %
 Peak intensity 5 cd/m
 LEDs/each optic 1
 Light colour White
 Required components:

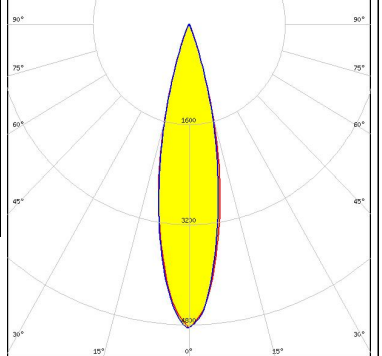

OPTICAL RESULTS (MEASURED):

<p>NICHIA</p> <p>LED NCSxE17A FWHM / FWTM 23.0° / 43.0° Efficiency 90 % Peak intensity 4.4 cd/lm LEDs/each optic 4 Light colour RGBW Required components:</p>		
<p>NICHIA</p> <p>LED NVSW219F FWHM / FWTM 24.0° / 40.0° Efficiency 89 % Peak intensity 5 cd/lm LEDs/each optic 1 Light colour White Required components:</p>		
<p>OSRAM <small>Opto Semiconductors</small></p> <p>LED OSTAR Stage (S2WN) FWHM / FWTM 23.0° / 40.0° Efficiency 89 % Peak intensity 5 cd/lm LEDs/each optic 1 Light colour White Required components:</p>		
<p>SEOUL SEMICONDUCTOR</p> <p>LED SPF05F0A FWHM / FWTM 24.0° / 40.0° Efficiency 89 % Peak intensity 4.9 cd/lm LEDs/each optic 1 Light colour RGBW Required components:</p>		

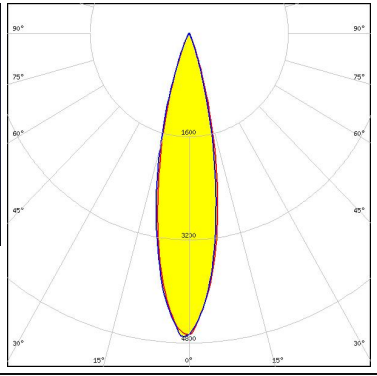
OPTICAL RESULTS (MEASURED):

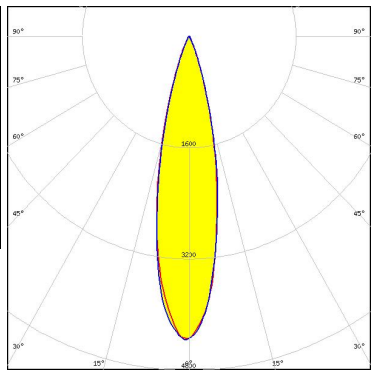
<p> SEOL SEMICONDUCTOR</p> <p>LED SPF05F0B</p> <p>FWHM / FWTM 23.5 + 24.0° / 41.0°</p> <p>Efficiency 88 %</p> <p>Peak intensity 4.7 cd/m</p> <p>LEDs/each optic 1</p> <p>Light colour RGBW</p> <p>Required components:</p>		
<p> SEOL SEMICONDUCTOR</p> <p>LED SPF05F0C</p> <p>FWHM / FWTM 23.0° / 43.0°</p> <p>Efficiency 87 %</p> <p>Peak intensity 4.4 cd/m</p> <p>LEDs/each optic 1</p> <p>Light colour RGBW</p> <p>Required components:</p>		

OPTICAL RESULTS (SIMULATED):



LED XM-L RGBW (XMLCTW)
 FWHM / FWTM 23.0°
 Efficiency 85 %
 Peak intensity 4.5 cd/lm
 LEDs/each optic 1
 Light colour White
 Required components:

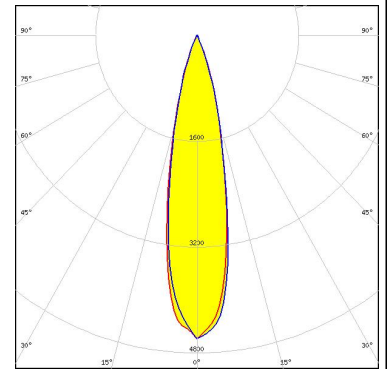

LED LUXEON C
 FWHM / FWTM 24.0°
 Efficiency 86 %
 Peak intensity 4 cd/lm
 LEDs/each optic 4
 Light colour RGBW
 Required components:

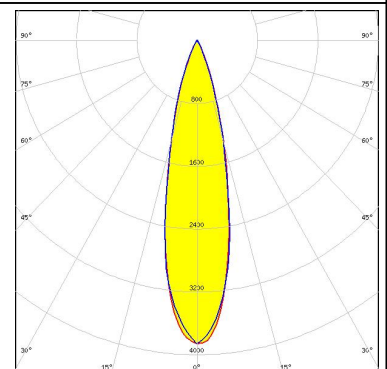

LED OSTAR Stage (S2WP)
 FWHM / FWTM 25.0°
 Efficiency 86 %
 Peak intensity 4 cd/lm
 LEDs/each optic 1
 Light colour White
 Required components:

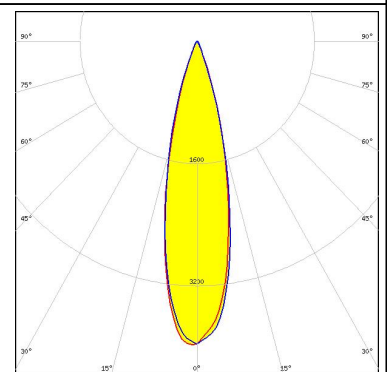

GENERAL INFORMATION:

NOTE: The typical beam angle will be changed by different color, chip size and chip position tolerance. The typical total beam angle is the full angle measured where the luminous intensity is half of the peak value.

MATERIALS:

As part of our continuous research and improvement processes, and to ensure the best possible quality and availability of our products, LEDiL reserves the right to change material grades without notice.

PRODUCT DATA USER AGREEMENT AND DISCLAIMER:

The measured data in the provided downloadable LEDiL Product Datasheets and Mechanical 2D-Drawings is rounded and provided as reference for planning. LEDiL Oy's optical specifications have been verified by conducting performance testing of the products in accordance with the company's quality system. The reported data are averaged results of multiple measurements with typical variation. LEDiL Oy reserves the right to without prior notification make changes and improvements to its products.

LEDiL Oy assumes neither warranty, nor guarantee nor any other liability of any kind for the contents and correctness of the provided data. The provided data has been generated with highest diligence but the provided data may in reality not represent the complete possible variation range of all intrinsic parameters. Therefore, in certain cases a deviation from the provided data could occur.

LEDiL Oy reserves the right to undertake technical changes of its products without further notification which could lead to changes in the provided data. LEDiL Oy assumes no liability of any kind for the possible deviation from any provided data or any other damage resulting from the usage of the provided data.

The user agrees to this disclaimer and user agreement with the download or usage of the provided files.

LEDiL Oy

Joensuunkatu 13
FI-24240 SALO
Finland

LEDiL Inc.

228 West Page Street
Suite D
Sycamore IL 60178
USA

Ledil Optics Technology (Shenzhen) Co., Ltd.

405 , Block B
Casic Motor Building
Shenzhen 518057
P.R.CHINA

Local sales and technical support

[www.ledil.com/
where_to_buy](http://www.ledil.com/where_to_buy)

Shipping locations

Salo, Finland
Hong Kong, China

Distribution Partners

[www.ledil.com/
where_to_buy](http://www.ledil.com/where_to_buy)