



ST3237

3 to 5.5V, 250Kbps, RS-232
Transceiver with stand-by

Feature summary

- 1µA low power shutdown with receivers active
- Guaranteed data rate
 - 250Kbps (normal operation)
 - 1Mbps (very high speed operation)
- Guaranteed slew rate range
 - 6V/µs (normal operation)
 - 24V/µs (very high speed operation)
- 0.1µF external capacitors
- Flow-through pinout
- 500uA low supply current
- Meet EIA/TIA-232 specifications down to 3V
- Available in SSOP

Description

The ST3237 is a 3V to 5.5V powered EIA/TIA-232 and V.28/V.24 communication interfaces high data-rate capabilities. ST3237 is a transceiver (5 drivers, 3 receivers) for fast modem applications. The device has a proprietary low-dropcut transmitter output stage providing true RS-232

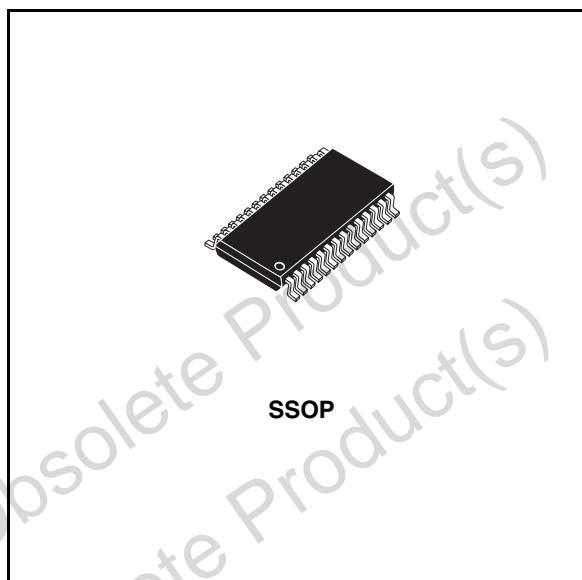

performance from a 3V to 5.5V supply using a dual charge pump. The device is guaranteed to run at data rates of 250Kbps in the normal operation mode and 1Mbps in the very high speed operation mode while maintaining RS-232 output levels.

Order codes

Part number	Temperature range	Package	Packaging
ST3237BPR	-40 to 85 °C	SSOP-28 (Tape & Reel)	1350 parts per reel

Contents

1	Pin configuration	3
2	Absolute maximum ratings	5
3	Electrical characteristics	6
4	Application circuit	8
5	Typical performance characteristics	9
6	Package mechanical data	11
7	Revision history	14

Obsolete Product(s) - Obsolete Product(s)
Obsolete Product(s) - Obsolete Product(s)

1 Pin configuration

Figure 1. Pin description

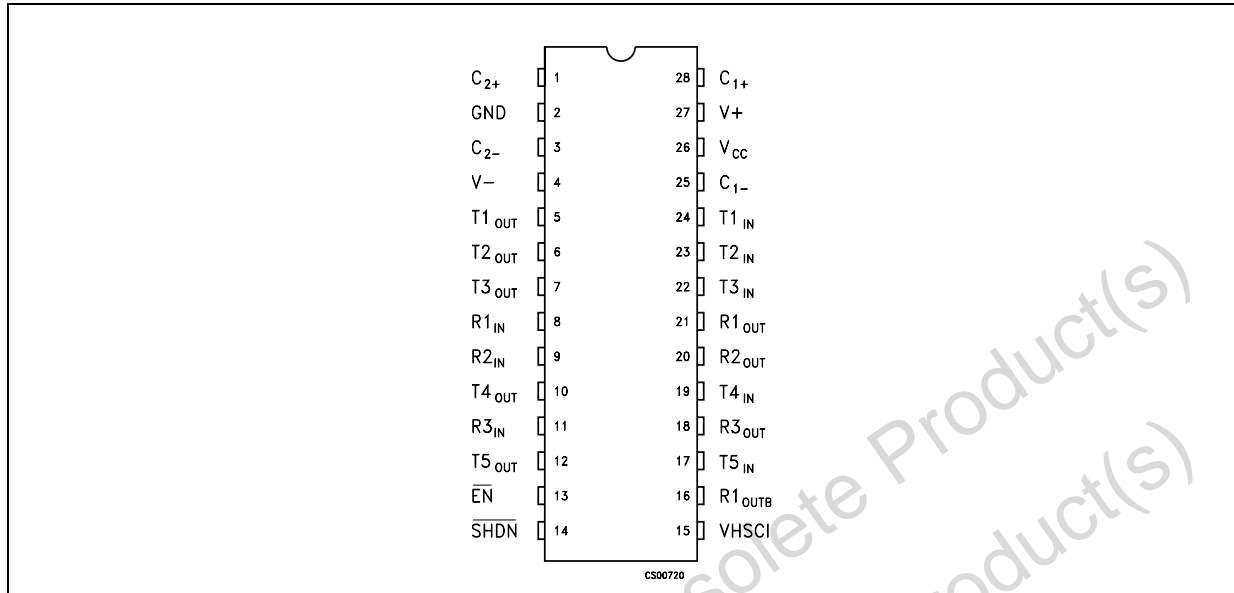

Table 1. Pin description

PIN N°	SYMBOL	NAME AND FUNCTION
1	C ₂₊	Positive Terminal of Inverting Charge Pump Capacitor
2	GND	Ground
3	C ₂₋	Negative Terminal of Inverting Charge Pump Capacitor
4	V-	5.5V Generated by the Charge Pump
5	T1 _{OUT}	First Transmitter Output Voltage
6	T2 _{OUT}	Second Transmitter Output Voltage
7	T3 _{OUT}	Third Transmitter Output Voltage
8	R1 _{IN}	First Receiver Input Voltage
9	R2 _{IN}	Second Receiver Input Voltage
10	T4 _{OUT}	Fourth Transmitter Output Voltage
11	R3 _{IN}	Third Receiver Input Voltage
12	T5 _{OUT}	Fifth Transmitter Output Voltage
13	EN	Receiver Enable, Active Low
14	SHDN	Shutdown Control, Active Low
15	VHSCI	Very High Speed Control Input. Connect to GND for normal operation; connect to VCC for 1Mbps transmission rates.
16	R1 _{OUTB}	Non Inverting Complementary Receiver Output. Always Active.
17	T5 _{IN}	Fifth Transmitter Input Voltage
18	R3 _{OUT}	Third Receiver Output Voltage

Table 1. Pin description

PIN N°	SYMBOL	NAME AND FUNCTION
19	T4 _{IN}	Fourth Transmitter Input Voltage
20	R2 _{OUT}	Second Receiver Output Voltage
21	R1 _{OUT}	First Receiver Output Voltage
22	T3 _{IN}	Third Transmitter Input Voltage
23	T2 _{IN}	Second Transmitter Input Voltage
24	T1 _N	First Transmitter Input Voltage
25	C ₁₋	Negative Terminal of Voltage- Charge Pump Capacitor
26	V _{CC}	Supply Voltage
27	V+	-5.5V Generated by the Charge Pump
28	C ₁₊	Positive Terminal of Voltage- Charge Pump Capacitor

2 Absolute maximum ratings

Table 2. Absolute maximum ratings

Symbol	Parameter	Value	Unit
V_{CC}	Supply voltage	-0.3 to 6	V
V+	Doubled voltage terminal	-0.3 to 7	V
V-	Inverted voltage terminal	0.3 to -7	V
$V+ + V- $		13	V
T_{IN}	Transmitter Input voltage range	-0.3 to 6	V
\overline{SHDN} , \overline{EN}		-0.3 to 6	V
VHSCI	Very high speed control input	-0.3 to ($V_{CC} + 0.3$)	V
R_{IN}	Receiver input voltage range	± 25	V
T_{OUT}	Transmitter output voltage range	± 13.2	V
R_{OUT} R_{OUTB}	Receiver output voltage range	-0.3 to ($V_{CC} + 0.3$)	V
t_{SHORT}	Short circuit duration on T_{OUT} (one at a time)	Continuous	
T_{STG}	Storage temperature range	-65 to 150	°C

Note: Absolute maximum ratings are those values beyond which damage to the device may occur. Functional operation under these condition is not implied. V+ and V- can have a maximum magnitude of +7V, but their absolute addition can not exceed 13 V.

3 Electrical characteristics

Table 3. Electrical characteristics ($C_1 - C_4 = 0.1\mu\text{F}$, $V_{CC} = 3\text{V}$ to 5.5V , $T_A = -40$ to 85°C , unless otherwise specified. Typical values are referred to $T_A = 25^\circ\text{C}$)

Symbol	Parameter	Test conditions	Min.	Typ.	Max.	Unit
I_{SUPPLY}	V_{CC} power supply current	No load $V_{CC} = 3\text{V}$ or 5.0V $T_A = 25^\circ\text{C}$		0.5	2	mA
I_{SHDN}	Shutdown supply current	SHDN=GND $T_A = 25^\circ\text{C}$		1	10	μA

Table 4. Logic input ($C_1 - C_4 = 0.1\mu\text{F}$, $V_{CC} = 3\text{V}$ to 5.5V , $T_A = -40$ to 85°C , unless otherwise specified. Typical values are referred to $T_A = 25^\circ\text{C}$)

Symbol	Parameter	Test Conditions	Min.	Typ.	Max.	Unit
V_{TIL}	Input logic threshold low (1)	T-IN, VHSCI, $\overline{\text{EN}}$, $\overline{\text{SHDN}}$			0.8	V
V_{TIH}	Input logic threshold high (1)	$V_{CC} = 3.3\text{V}$ $V_{CC} = 5\text{V}$	2 2.4			V V
I_{IL}	Input leakage current	T-IN, VHSCI, $\overline{\text{EN}}$, $\overline{\text{SHDN}}$		± 0.01	± 1.0	μA
I_{OL}	Output leakage current	Receiver disabled		± 0.05	± 10	μA
V_{OL}	Output voltage low	$I_{\text{OUT}} = 1.6\text{mA}$			0.4	V
V_{OH}	Output voltage high	$I_{\text{OUT}} = -1\text{mA}$	$V_{CC} - 0.6$	$V_{CC} - 0.1$		V

1. Transmitter input hysteresis is typically 250mV

Table 5. Transmitter ($C_1 - C_4 = 0.1\mu\text{F}$ tested at $3.3\text{V} \pm 10\%$, $V_{CC} = 3\text{V}$ to 5.5V , $T_A = -40$ to 85°C , unless otherwise specified. Typical values are referred to $T_A = 25^\circ\text{C}$)

Symbol	Parameter	Test conditions	Min.	Typ.	Max.	Unit
V_{TOUT}	Output voltage swing	All transmitter outputs are loaded with $3\text{K}\Omega$ to GND	± 5	± 5.4		V
R_{TOUT}	Transmitter output resistance	$V_{CC} = V_+ = V_- = 0\text{V}$ $V_{\text{OUT}} = \pm 2\text{V}$		3000		W
I_{SC}	Output short circuit current			± 25	± 60	mA

Table 6. Receiver ($C_1 - C_4 = 0.1\mu\text{F}$ tested at $3.3\text{V}\pm 10\%$, $V_{\text{CC}} = 3\text{V}$ to 5.5V , $T_A = -40$ to 85°C , unless otherwise specified. Typical values are referred to $T_A = 25^\circ\text{C}$)

Symbol	Parameter	Test Conditions	Min.	Typ.	Max.	Unit
V_{RIN}	Receiver input voltage operating range		-25		25	V
V_{RIL}	RS-232 input threshold low	$T_A = 25^\circ\text{C}$, $V_{\text{CC}} = 3.3\text{V}$	0.6	1.2		V
		$T_A = 25^\circ\text{C}$, $V_{\text{CC}} = 5\text{V}$	0.8	1.5		V
V_{RIH}	RS-232 input threshold high	$T_A = 25^\circ\text{C}$, $V_{\text{CC}} = 3.3\text{V}$		1.5	2.4	V
		$T_A = 25^\circ\text{C}$, $V_{\text{CC}} = 5\text{V}$		1.8	2.4	V
V_{RIHYS}	Input hysteresis			0.3		V
R_{RIN}	Input resistance	$T_A = 25^\circ\text{C}$	3	5	7	$\text{K}\Omega$

Table 7. Timing characteristics ($C_1 - C_4 = 0.1\text{mF}$ tested at $3.3\text{V}\pm 10\%$, $V_{\text{CC}} = 3\text{V}$ to 5.5V , $T_A = -40$ to 85°C , unless otherwise specified. Typical values are referred to $T_A = 25^\circ\text{C}$)

Symbol	Parameter	Test Conditions	Min.	Typ.	Max.	Unit
D_{R}	Maximum data rate	$R_L = 3\text{K}\Omega$, $C_L = 1000\text{pF}$ one transmitter switching, $V_{\text{HSCI}} = \text{GND}$	250			Kbps
		$R_L = 3\text{K}\Omega$, $C_L = 250\text{pF}$ one transmitter switching, $V_{\text{HSCI}} = V_{\text{CC}}$ $V_{\text{CC}} = 3$ to 5.5V	1000			Kbps
t_{PHLR} t_{PLHR}	Propagation delay input to output	R_{IN} to R_{OUT} , $C_L = 150\text{pF}$		0.15		μs
$t_{\text{T_SKEW}}$	Transmitter skew	$ t_{\text{PHL}} - t_{\text{TLH}} $, $V_{\text{HSCI}} = \text{GND}$		100		ns
		$ t_{\text{PHL}} - t_{\text{TLH}} $, $V_{\text{HSCI}} = V_{\text{CC}}$		60		ns
$t_{\text{R_SKEW}}$	Receiver skew	$ t_{\text{PHL}} - t_{\text{TLH}} $		50		ns
t_{OER}	Receiver output enable time	Normal operation		80		ns
t_{ODR}	Receiver output disable time	Normal operation		130		ns
S_{RT}	Transition slew rate	$T_A = 25^\circ\text{C}$ $R_L = 3$ to $7\text{K}\Omega$ $V_{\text{CC}} = 3.3\text{V}$ measured from $+3\text{V}$ to -3V or -3V to $+3\text{V}$ $C_L = 150\text{pF}$ to 1000pF , $V_{\text{HSCI}} = \text{GND}$	6		30	$\text{V}/\mu\text{s}$
		$C_L = 150\text{pF}$ to 1000pF , $V_{\text{HSCI}} = V_{\text{CC}}$	24		150	$\text{V}/\mu\text{s}$
		$C_L = 150\text{pF}$ to 2500pF , $V_{\text{HSCI}} = \text{GND}$	4		30	$\text{V}/\mu\text{s}$

Note: Transmitter Skew is measured at the transmitter zero cross points

4 Application circuit

Figure 2. Application circuits

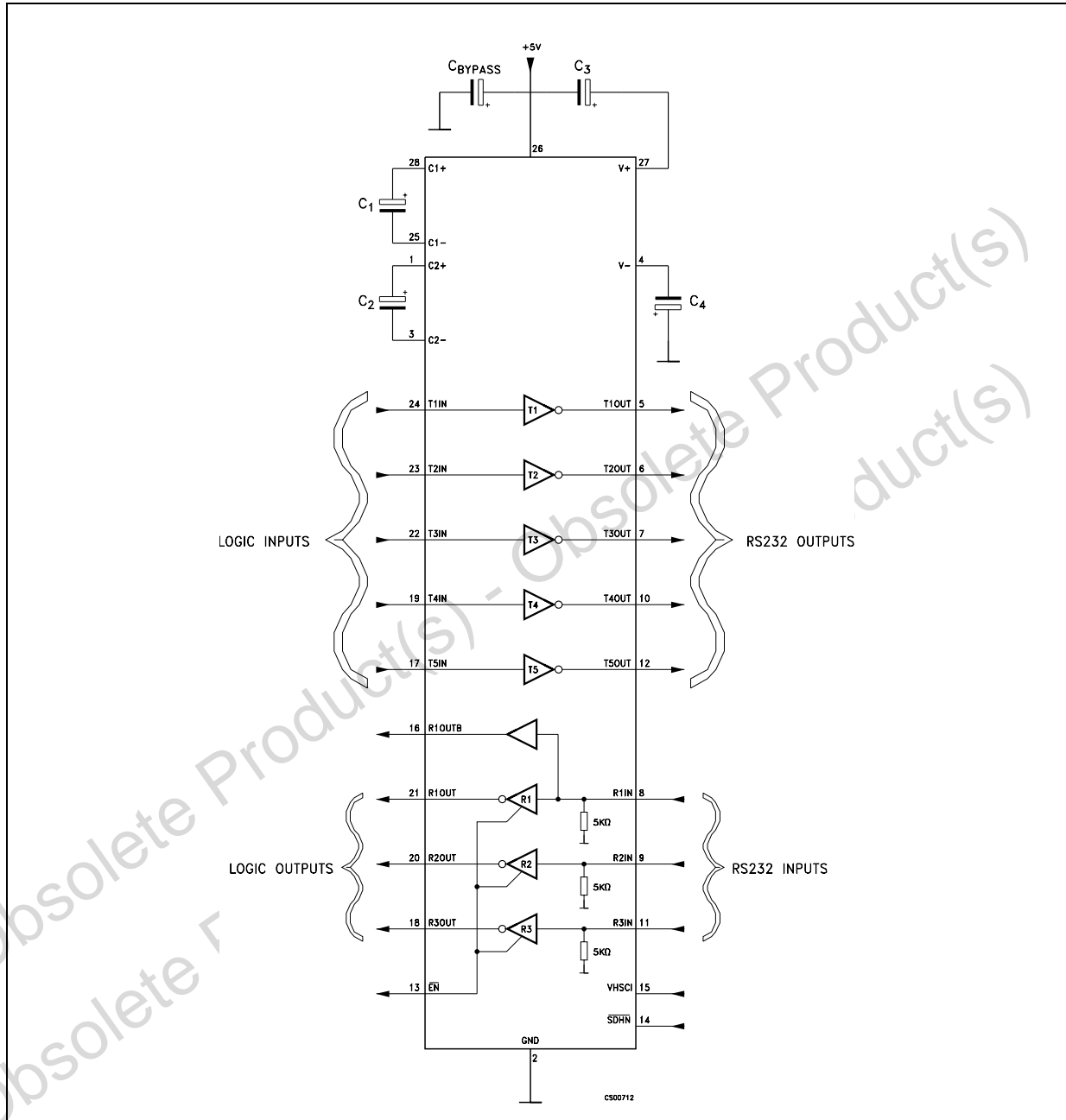

Table 8. Capacitance value (μF)

V_{CC}	C1	C2	C3	C4	Cbypass
3.0 to 3.6	0.1	0.1	0.1	0.1	0.1
4.5 to 5.5	0.047	0.33	0.33	0.33	0.1
3.0 to 5.5	0.1	0.47	0.47	0.47	0.1

5 Typical performance characteristics

(unless otherwise specified $T_J = 25^\circ\text{C}$)

Figure 3. Input voltage range $T_J = 25^\circ\text{C}$

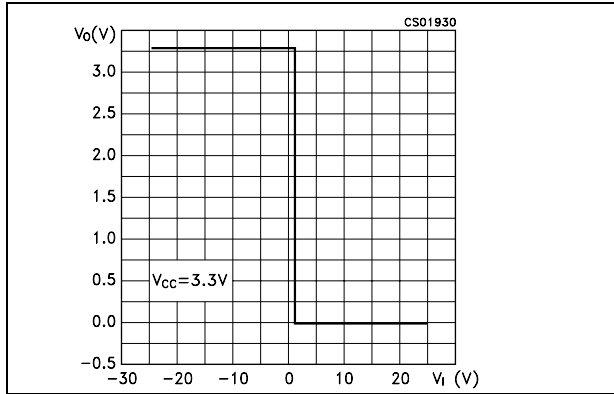

Figure 4. Transfer characteristics for transmitter

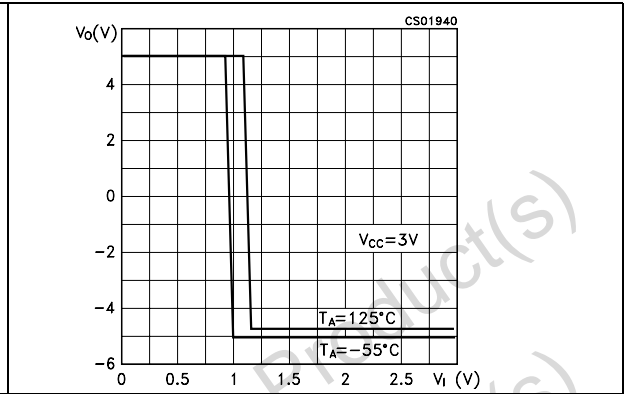

Figure 5. Transfer characteristics for receiver **Figure 6. Transfer characteristics for received**

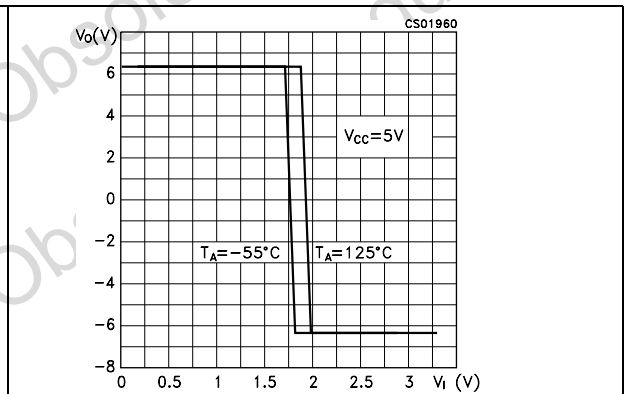
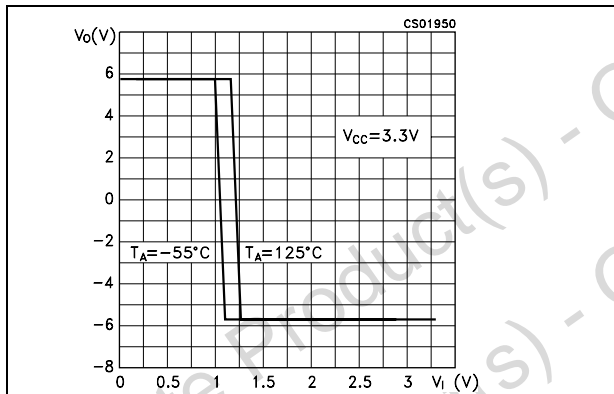

Figure 7. Output current vs output high voltage

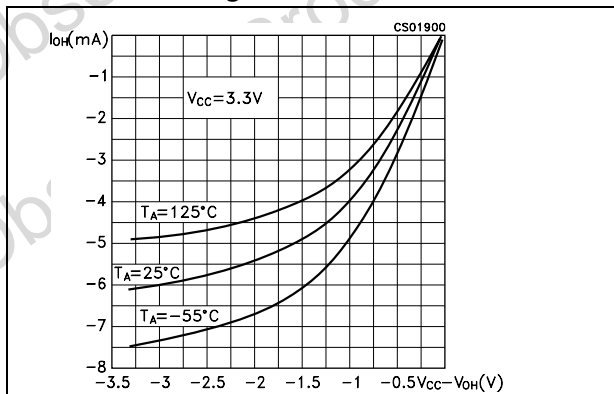

Figure 8. Output current vs output low voltage

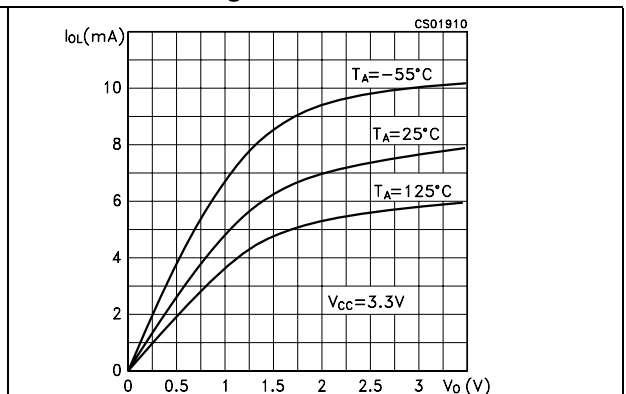
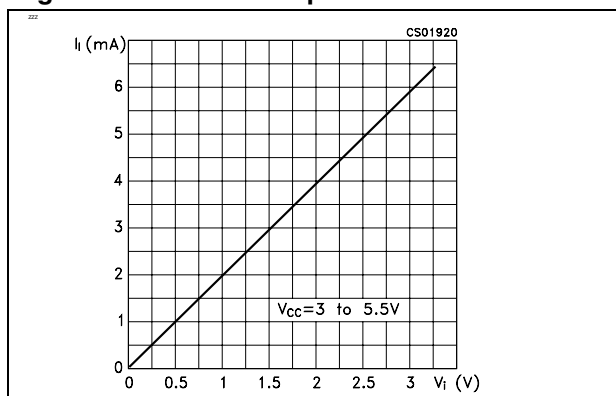

Figure 9. Receiver input resistance



Obsolete Product(s) - Obsolete Product(s)
Obsolete Product(s) - Obsolete Product(s)

6 Package mechanical data

In order to meet environmental requirements, ST offers these devices in ECOPACK® packages. These packages have a Lead-free second level interconnect. The category of second level interconnect is marked on the package and on the inner box label, in compliance with JEDEC Standard JESD97. The maximum ratings related to soldering conditions are also marked on the inner box label. ECOPACK is an ST trademark. ECOPACK specifications are available at: www.st.com.

Obsolete Product(s) - Obsolete Product(s)
Obsolete Product(s) - Obsolete Product(s)

SSOP28 MECHANICAL DATA

DIM.	mm.			inch		
	MIN.	TYP	MAX.	MIN.	TYP.	MAX.
A			2			0.079
A1	0.050			0.002		
A2	1.65	1.75	1.85	0.065	0.069	0.073
b	0.22		0.38	0.009		0.015
c	0.09		0.25	0.004		0.010
D	9.9	10.2	10.5	0.390	0.402	0.413
E	7.4	7.8	8.2	0.291	0.307	0.323
E1	5	5.3	5.6	0.197	0.209	0.220
e		0.65 BSC			0.0256 BSC	
K	0°		10°	0°		10°
L	0.55	0.75	0.95	0.022	0.030	0.037

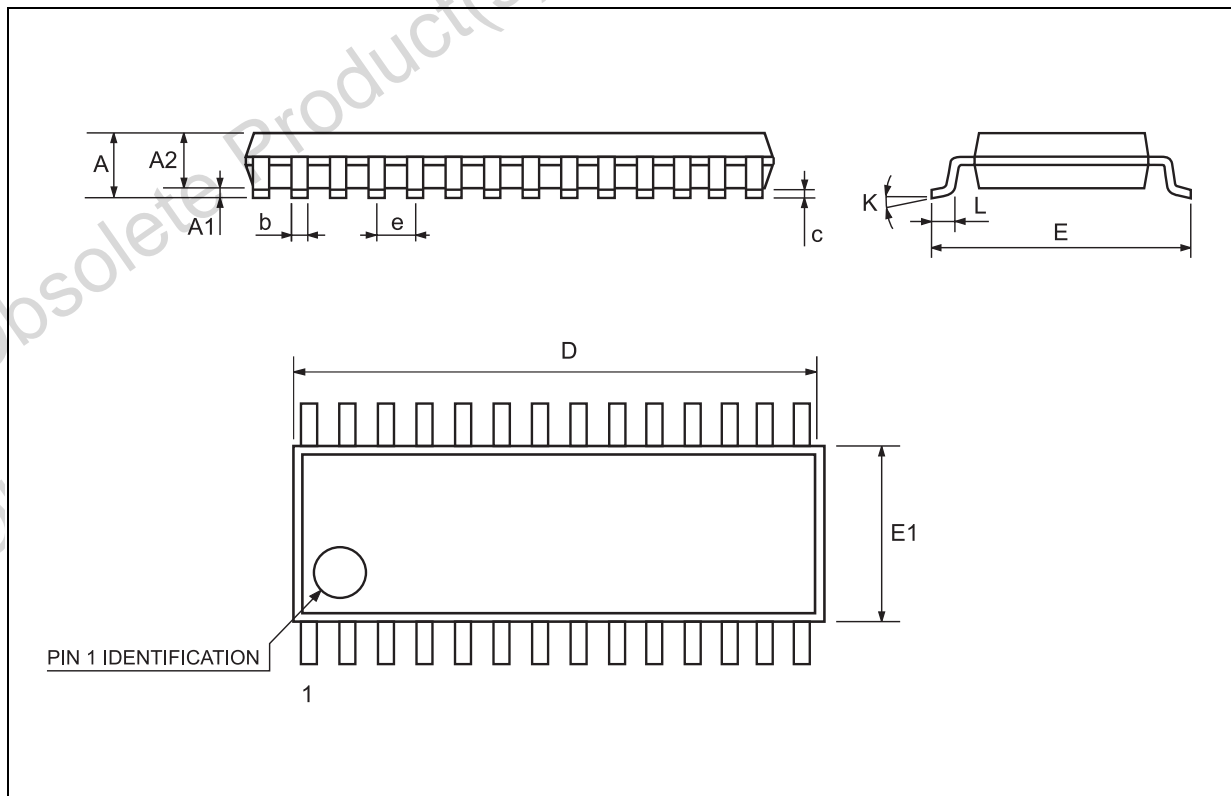

Tape & Reel SSOP28 MECHANICAL DATA

DIM.	mm.			inch		
	MIN.	TYP	MAX.	MIN.	TYP.	MAX.
A			330			12.992
C	12.8		13.2	0.504		0.519
D	20.2			0.795		
N	60			2.362		
T			22.4			0.882
Ao	8.4		8.6	0.331		0.339
Bo	10.7		10.9	0.421		0.429
Ko	2.9		3.1	0.114		0.122
Po	3.9		4.1	0.153		0.161
P	11.9		12.1	0.468		0.476

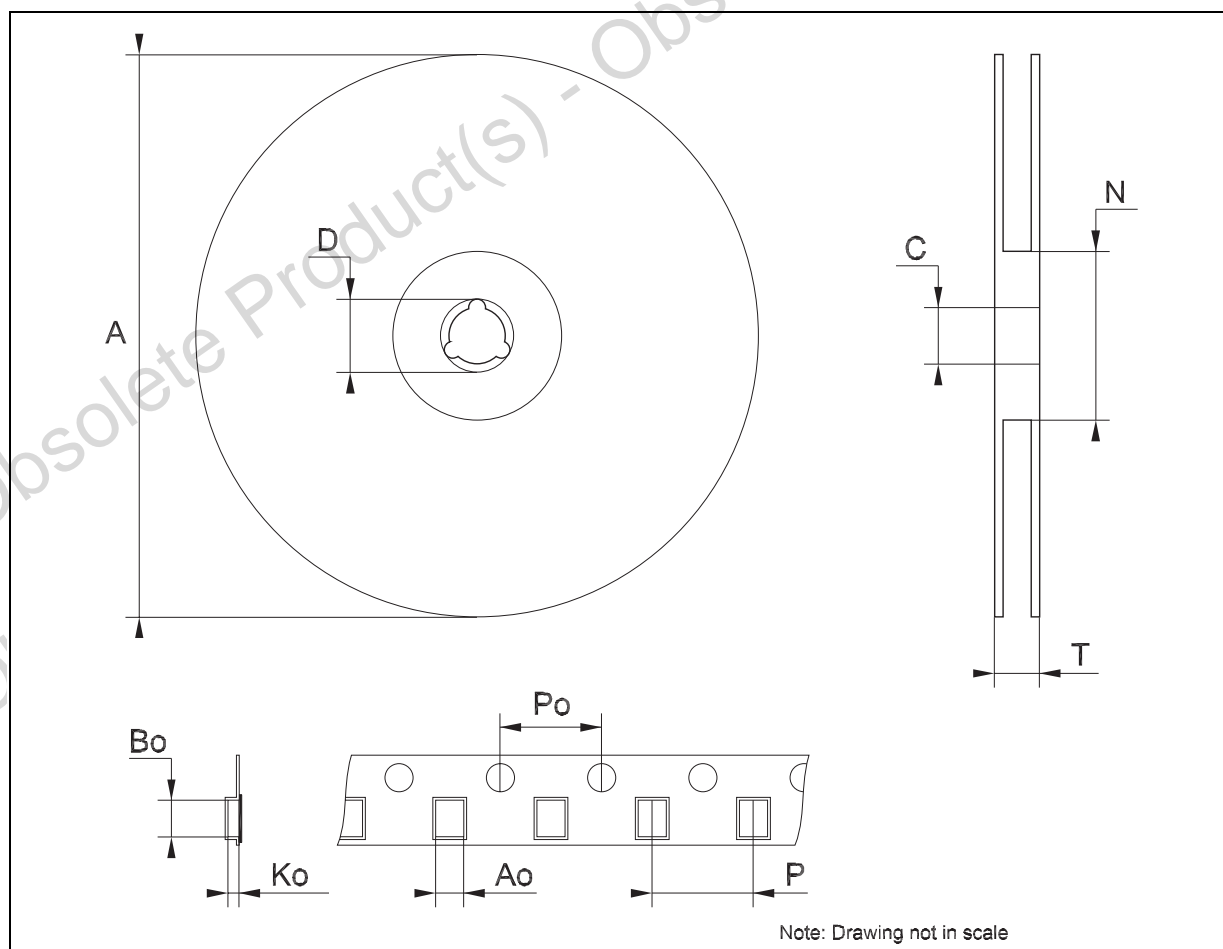

7 Revision history

Table 9. Revision history

Date	Revision	Description of Changes
21-Mar-2005	5	TSSOP has been removed.
24-Mar-2006	6	Order codes has been updated and new template.
25-Oct-2006	7	Order codes has been updated.
16-Jan-2007	8	The D_R min. value on Table 7 . has been corrected: 100kbps ==> 1000kbps.

Obsolete Product(s) - Obsolete Product(s)
Obsolete Product(s) - Obsolete Product(s)

Please Read Carefully:

Information in this document is provided solely in connection with ST products. STMicroelectronics NV and its subsidiaries ("ST") reserve the right to make changes, corrections, modifications or improvements, to this document, and the products and services described herein at any time, without notice.

All ST products are sold pursuant to ST's terms and conditions of sale.

Purchasers are solely responsible for the choice, selection and use of the ST products and services described herein, and ST assumes no liability whatsoever relating to the choice, selection or use of the ST products and services described herein.

No license, express or implied, by estoppel or otherwise, to any intellectual property rights is granted under this document. If any part of this document refers to any third party products or services it shall not be deemed a license grant by ST for the use of such third party products or services, or any intellectual property contained therein or considered as a warranty covering the use in any manner whatsoever of such third party products or services or any intellectual property contained therein.

UNLESS OTHERWISE SET FORTH IN ST'S TERMS AND CONDITIONS OF SALE ST DISCLAIMS ANY EXPRESS OR IMPLIED WARRANTY WITH RESPECT TO THE USE AND/OR SALE OF ST PRODUCTS INCLUDING WITHOUT LIMITATION IMPLIED WARRANTIES OF MERCHANTABILITY, FITNESS FOR A PARTICULAR PURPOSE (AND THEIR EQUIVALENTS UNDER THE LAWS OF ANY JURISDICTION), OR INFRINGEMENT OF ANY PATENT, COPYRIGHT OR OTHER INTELLECTUAL PROPERTY RIGHT.

UNLESS EXPRESSLY APPROVED IN WRITING BY AN AUTHORIZE REPRESENTATIVE OF ST, ST PRODUCTS ARE NOT DESIGNED, AUTHORIZED OR WARRANTED FOR USE IN MILITARY, AIR CRAFT, SPACE, LIFE SAVING, OR LIFE SUSTAINING APPLICATIONS, NOR IN PRODUCTS OR SYSTEMS, WHERE FAILURE OR MALFUNCTION MAY RESULT IN PERSONAL INJURY, DEATH, OR SEVERE PROPERTY OR ENVIRONMENTAL DAMAGE.

Resale of ST products with provisions different from the statements and/or technical features set forth in this document shall immediately void any warranty granted by ST for the ST product or service described herein and shall not create or extend in any manner whatsoever, any liability of ST.

ST and the ST logo are trademarks or registered trademarks of ST in various countries.

Information in this document supersedes and replaces all information previously supplied.

The ST logo is a registered trademark of STMicroelectronics. All other names are the property of their respective owners.

© 2007 STMicroelectronics - All rights reserved

STMicroelectronics group of companies

Australia - Belgium - Brazil - Canada - China - Czech Republic - Finland - France - Germany - Hong Kong - India - Israel - Italy - Japan - Malaysia - Malta - Morocco - Singapore - Spain - Sweden - Switzerland - United Kingdom - United States of America

www.st.com